

43 **TEAC®**

SERVICE MANUAL

A 2340 R.

A-2340SX

4-Channel Stereo Tape Deck



TEAC CORPORATION

51031880



1. GENERAL DESCRIPTION

This TEAC A-2340SX 4 channel open reel tape deck was manufactured with pride by the craftsmen of TEAC Corporation. It contains all of the features which made the earlier A-2340RS one of the most popular 4 channel open reel tape decks ever sold. In addition, the A-2340SX has built-in SIMUL-SYNC and an added CUE lever function. It offers operating speeds of 7-1/2 ips and 3-3/4 ips.

The basic design of the A-2340SX is highly similar to that of the A-2340RS. Therefore, much of the information in this service manual may be applied to the A-2340RS also.



TABLE OF CONTENTS

1. General Description	3
2. Specification and Service Data	4
3. Tools for Testing and Maintenance	5
4. Partial Dis-assembly	6
5. Tape Transport Parts Location	8
6. Head Replacement and Alignment	9
7. Measurement and Adjustment	10
—MECHANICAL—	
8. Measurement and Adjustment	13
—ELECTRICAL—	
9. Trouble-shooting	20
10. Service and Maintenance	21
11. Simplified Schematic with level indications	22

2. SPECIFICATIONS AND SERVICE DATA

2-1 SPECIFICATIONS

Track System	1/4 Track 4 channel stereophonic 1/4 Track 2 channel stereophonic 1/4 Track 1 channel monophonic
Heads	Three; Erase, Record and Playback
Reel Size	7" maximum reel
Tape Speed	7-1/2 ips and 3-3/4 ips $\pm 0.5\%$
Inputs (Level and Impedance)	MIC: Specified; -60 dB (0.774 mV) / 10k ohms Minimum; -70 dB (0.244 mV) LINE: Specified; -8 dB (308 mV) / 50k ohms Minimum -18 dB (97 mV)
Outputs (Level and Impedance)	HEADPHONE; -24 dB (49 mV) / 8 ohms LINE: Specified; -8 dB (308 mV) / 50 k ohms Maximum; -2 dB (615 mV)
Playback Equalization	7-1/2 ips (19 cm/sec) : NAB 3180 μ sec, 50 μ sec 3-3/4 ips (9.5 cm/sec) : NAB 3180 μ sec, 90 μ sec
Motors	One dual speed hysteresis synchronous capstan motor Two eddy current induction reel motors
Bias Frequency	100k Hz (± 5 kHz, Push-Pull Oscillator)
Power Requirement	100, 117, 220, 240 V AC 50 Hz/60 Hz 110 W TCA (U.S.A. and Canada) 117 V AC 60 Hz
Dimensions (WHD)	440 x 475 x 220 mm (17-5/16" x 18-11/16" x 8-11/16")
Weight	21 kg (46 lbs) net

2-2 SERVICE DATA —MECHANICAL—

Tape Speed Deviation and Drift	3,000 ± 30 Hz, within 15 Hz
Wow and Flutter	Playback: 0.18% (RMS) at 7-1/2 ips 0.20% (RMS) at 3-3/4 ips Overall: 0.20% (RMS) at 7-1/2 ips 0.25% (RMS) at 3-3/4 ips
Pinch Roller Pressure	2.1 kg (4.6 lbs) ± 0.1 kg
Reel Torque	Take up Torque; 380 to 400 g.cm (5.3 to 5.6 oz-inch) Back Tension; 180 to 210 g.cm (2.5 to 2.9 oz-inch)
Brake Torque	800 to 1200 g.cm (11 to 17 oz-inch)
Fast Forward/Rewind Time	90 seconds for 1200 foot tape

2-3 SERVICE DATA —ELECTRICAL—

Frequency Response	Refer to Frequency Response Limits charts in this manual.
Signal-to-Noise Ratio	Overall: 47 dB or higher at 7-1/2 ips 45 dB or higher at 3-3/4 ips
Erase Efficiency	65 dB or more at 1 kHz signal (Measured with input 10 dB higher than the Specified Input Level)
Cross Talk Rejection	35 dB or more, adjacent track at 125 Hz
Stereo Channel Separation	45 dB or more, channel to channel at 1 kHz
Total Harmonic Distortion	Overall: 1.5% or less at 1 kHz signal

NOTE: As a result of continuing changes and improvements during the production run, minor differences may be found between early and later machines. Value of "dB" in this manual refers to 0 dB = 0.775 V.

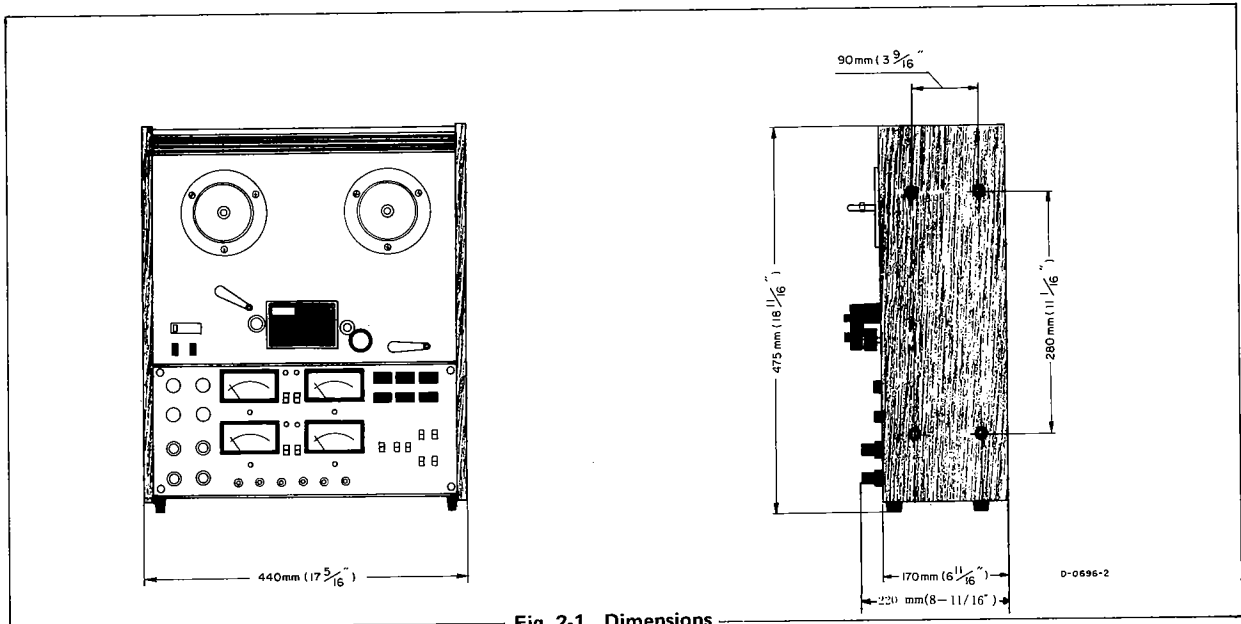

Fig. 2-1 Dimensions

3. TOOLS FOR TESTING AND MAINTENANCE

A minimum of the following tools and test instruments are required for measuring and adjusting to obtain optimum performance. Regular maintenance tools will be adequate for those not listed here. If any test instrument listed here is not available, a close equivalent can be used.

- SPRING SCALE 0-4 kg (0- 8 lbs)
0-300 g (0-10 oz)
- FLUTTER METER Meguro Denpa Sokki K.K.,
Model MK-668A
- DIGITAL COUNTER Range; 0 Hz-100 kHz
- BANDPASS FILTER TEAC MODEL M-206A (1 kHz)
- VTVM (AC) Hewlett-Packard Co., Model 400E
- AF OSCILLATOR 10 Hz-100 kHz
- ATTENUATOR General purpose
- OSCILLOSCOPE General purpose
- BLANK TAPE TEACYTT-8023 and YTT-8003
- TEAC TEST TAPE YTT-1003 (7-1/2 ips), YTT-1002
(3-3/4 ips) for Playback Alignment test
YTT-2003 (7-1/2 ips), YTT-2002
(3-3/4 ips) for Tape Speed
and Wow Flutter test
- TEAC EMPTY REEL RE-702 (2.5" dia, hub)
RE-701 (4" dia, hub)
- TOOLS General
2 mm nut driver
Hex Head Allen Wrench
Plastic alignment tool
Load resistor non inductive type 8 ohm / 1 W
- DEMAGNETIZER TEAC E-3 or equivalent

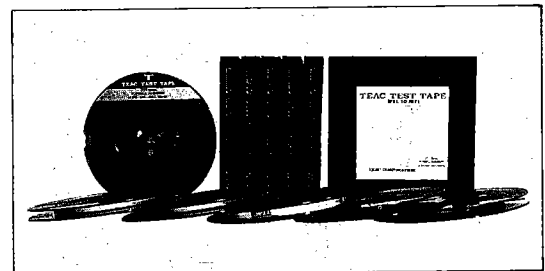

Fig. 3-1 TEAC Test Tape

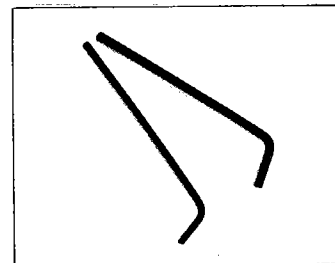

Fig. 3-2 Hex Head (Allen) wrench

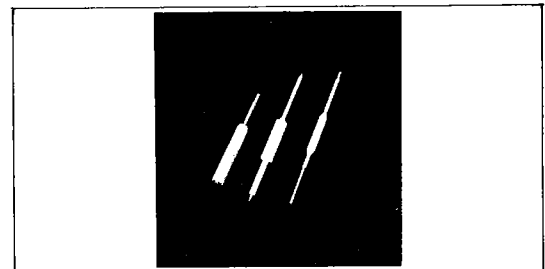
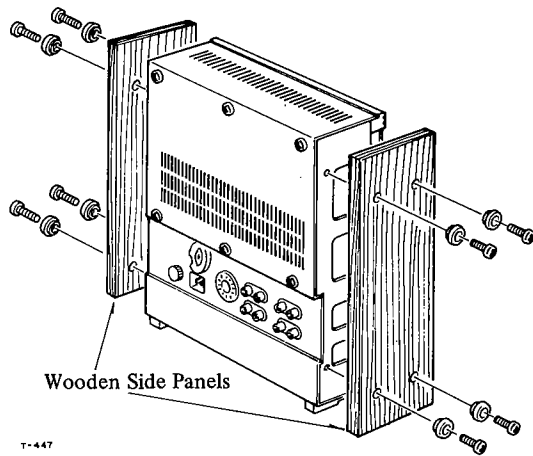

Fig. 3-3 Plastic alignment Tools

4. PARTIAL DIS-ASSEMBLY

4-1 REMOVING WOODEN SIDES AND REAR PANEL

See illustration for complete dis-assembly instructions. Most amplifier checks and adjustments can be made from the bottom with the (bottom) panel removed. These adjustments should be performed by experienced technicians, and then only when going through the complete test and check procedures on the unit which is being tested.



T-447

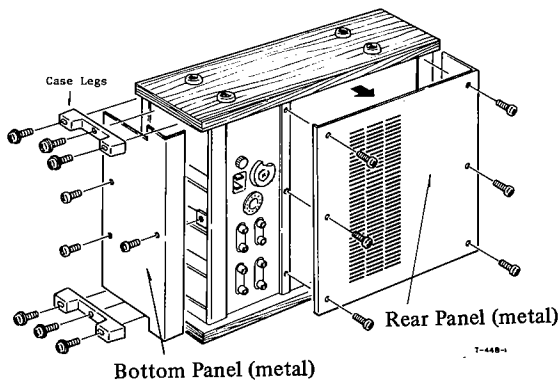

T-448-1

Fig. 4-1 Removing Wooden Sides and Rear and Bottom panels

4-2 HEAD ASSEMBLY REMOVAL

1. Remove the two screws in the top of the head cover and lift it off.
2. Remove the two screws from the SIMUL-SYNC switch ass'y. (A)
3. Remove two screws holding fiber insulator. (B)
4. Remove two screws holding head mounting plate. (C)
5. Remove two mounting nuts through access slot in head mounting plate. (1 nut for erase head) See Fig. 6-1 on page 9.

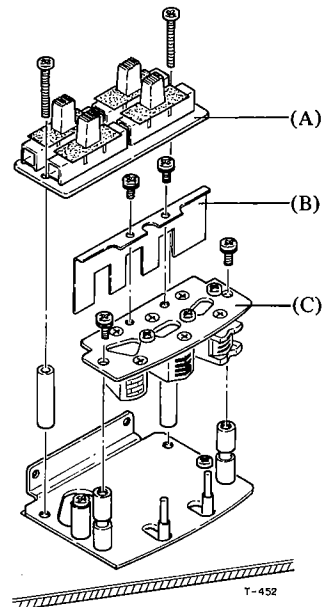

T-452

Fig. 4-2 Head Ass'y Removal

4-3 REMOVAL OF CAPSTAN MOTOR

1. Remove the 3 screws holding the capstan motor plate.
2. Unsolder the 6 wires connecting the capstan motor.
3. Remove the 4 screws holding the capstan motor to the motor plate. Watch for the Rubber Cushions.
4. Loosen the 2 set screws (hex head) in pulley and lift off pulley. Loosen 2 set screws in fan and remove fan.

NOTE: TCA versions of the A-2340SX have a different pulley than that shown and have no Frequency Selector switch.

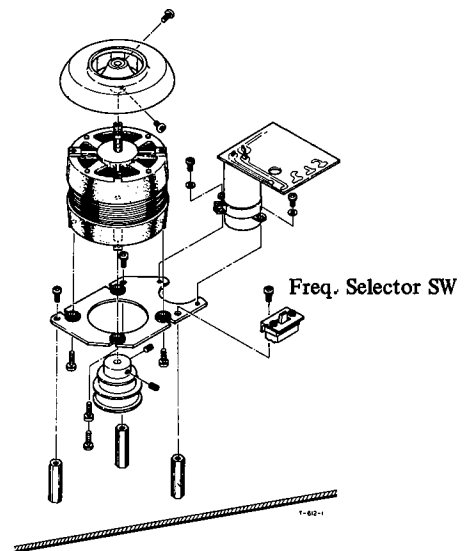

Freq. Selector SW

T-60-1

Fig. 4-3 Capstan Motor Removal

4-4 REMOVAL OF CAPSTAN ASSEMBLY

1. Unscrew dust cap (5) on front panel.
2. Remove 2 screws from Thrust Angle (1). Allow bracket to drop toward floor of case.
3. Remove capstan belt (3).
4. Loosen 2 screws in flywheel (2). Remove flywheel.
5. Remove 3 screws in capstan ass'y (4).
6. Gently move capstan ass'y up and down until it slides out of panel.

NOTE: When replacing flywheel, position flywheel on capstan ass'y shaft so that end of shaft protrudes slightly from rear of flywheel. A clearance of approx. 0.01" must be maintained between the end of the capstan shaft and the Thrust Angle.

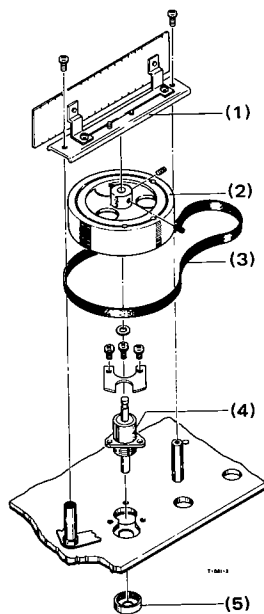

Fig. 4-4 Capstan Ass'y Removal

4-5 REMOVAL OF REEL MOTOR

1. Disconnect the 4 motor wires from terminals and release wire harness straps.
2. Loosen 2 set screws (hex head) in Brake drum(A) and 2 in the Reel Turntable assembly(F). Lift off these parts.
3. Remove 4 screws securing the Brake Assembly(D) to the motor. Carefully lift off the Brake Retainer(B). Do not remove wires connected to the brake solenoid(C).
4. Remove 4 screws securing Reel Motor(E) to chassis through the front panel.

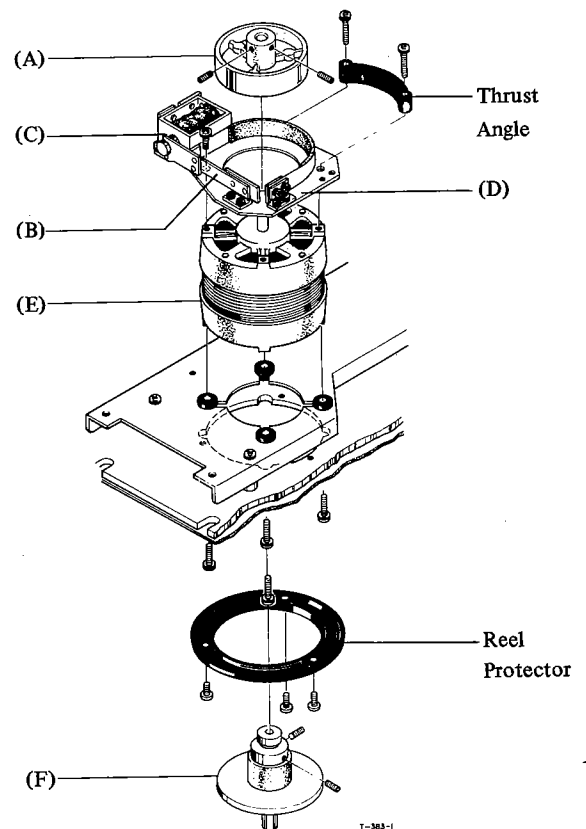

Fig. 4-5 Reel Motor Removal

4-6 REMOVAL OF TENSION ARMS LEFT AND RIGHT

See illustration for complete dis-assembly instructions.

NOTE: After re-assembly check clearance to ascertain that arm moves freely and is not binding. Do not over-tighten screws holding micro-switches. Insulating spacer and micro-switches are easily broken by excess pressure.

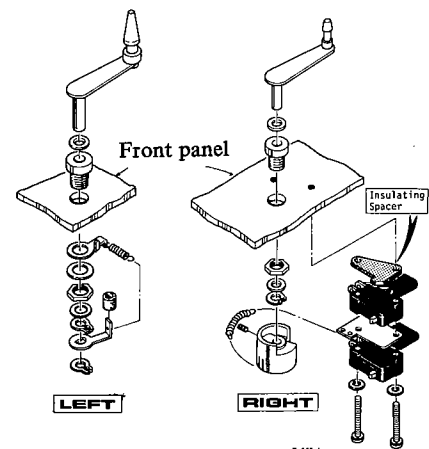
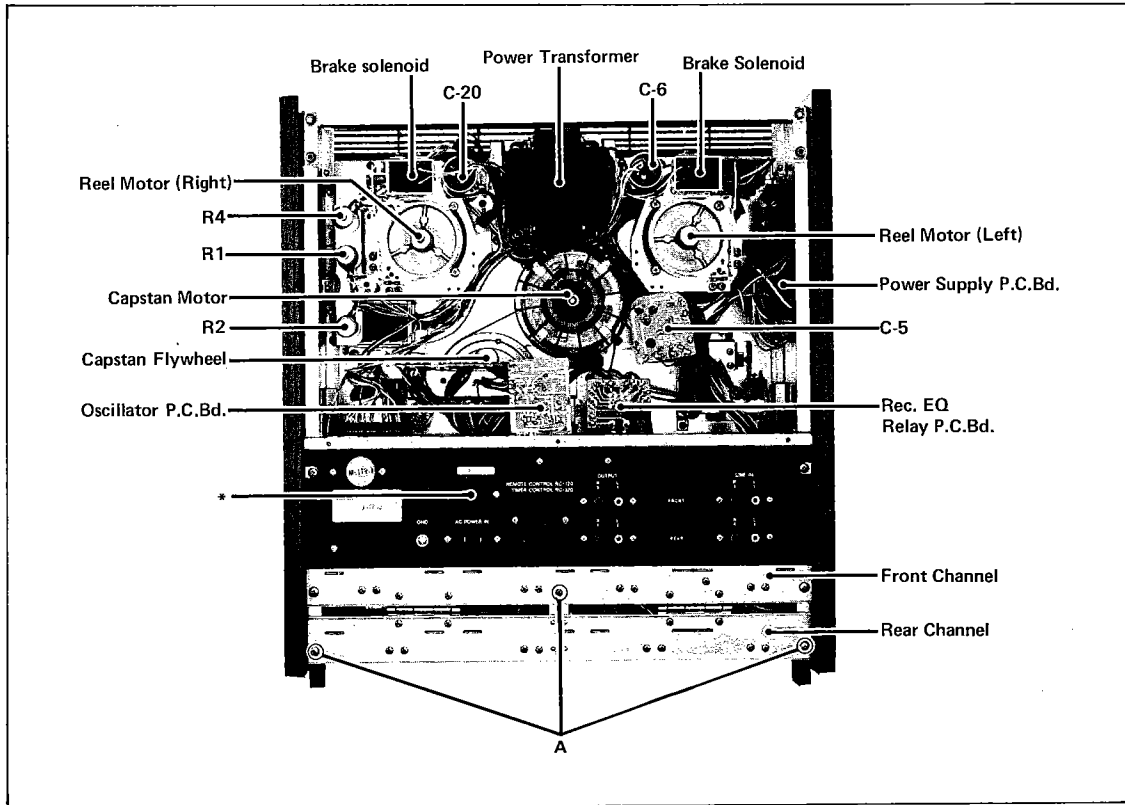

Fig. 4-6 Tension Arms Removal

5. TAPE TRANSPORT PARTS LOCATION

-REAR VIEW-



- NOTE:**
1. * mark for Voltage conversion, refer to page 12 section 7-8 VOLTAGE AND FREQUENCY CONVERSION for more detailed explanation.
 2. R1 and R2 are adjustable wire wound Resistors which are used to adjust Take-up torque and Back tension. Refer to page 11 for the TORQUE MEASUREMENT procedure.
 3. The REAR Channel circuit board panel is hinged and must be rotated down to allow access to the FRONT Channel adjustment. It is necessary to remove the three screws marked A to allow the REAR Channel panel to be rotated down.

6. HEAD REPLACEMENT AND ALIGNMENT

-MECHANICAL-

6-1 HEAD REPLACEMENT AND WIRING

To replace a single head a special 2 mm nut driver is required. Remove the 2 nuts (A) on the defective head through the access hole provided. This releases the head from the mounting plate. Note the position of the wires on the circuit board. Connect the new head in the same manner. Replace the nuts securing the new head to the plate. Perform head alignment before operation.

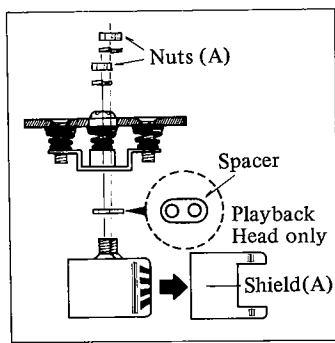

Fig. 6-1 Head Replacement

6-3 VISUAL HEAD ALIGNMENT

Coarse Adjustment:

HEIGHT

Height adjustment of the heads is very important to insure that the tracks of each head line up with the tracks on the other two heads. This alignment can be checked visually by looking at the position of the heads in relation to the tape as the tape is guided across the heads. Adjust the height adj. screws of each head so that the tape is centered on the heads as shown in Fig. 6-3.

AZIMUTH

The Azimuth adj. of the heads is necessary to insure that the poles (gaps) of each head are perpendicular to the tape travel. This adjustment is checked by comparing the signal level and phase as explained in the Electrical procedures 8-4 and 8-17.

TANGENCY AND TILT

The tangency and tilt adj. may be checked visually and can be adjusted by physically repositioning the heads. Loosen the head mounting nuts if necessary to do this. Normally the Tangency and tilt adjustment is done first, then the height adj. and finally the azimuth adjustment.

NOTE: After these adjustments have been made, be sure that all head surfaces are parallel with the tape guide surfaces when viewed from the side.

6-2 HEAD ADJ. SCREWS AND ALIGNMENT

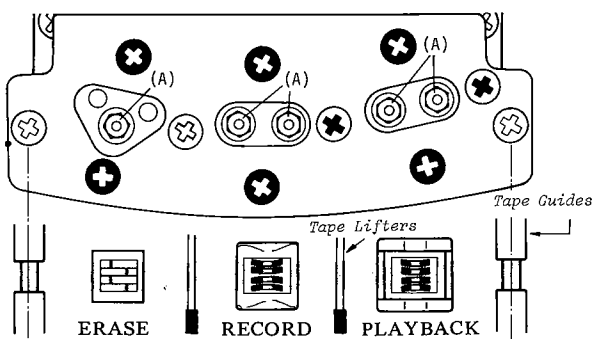

- ⊕ Azimuth adj. screws
- ⊕ Height and Tilt adj. screws
- ⊙ Tangency adj. Nuts

Fig. 6-2 Head Adjustment Screws and Alignment

6-4 MIS-ALIGNMENT OF THE HEADS

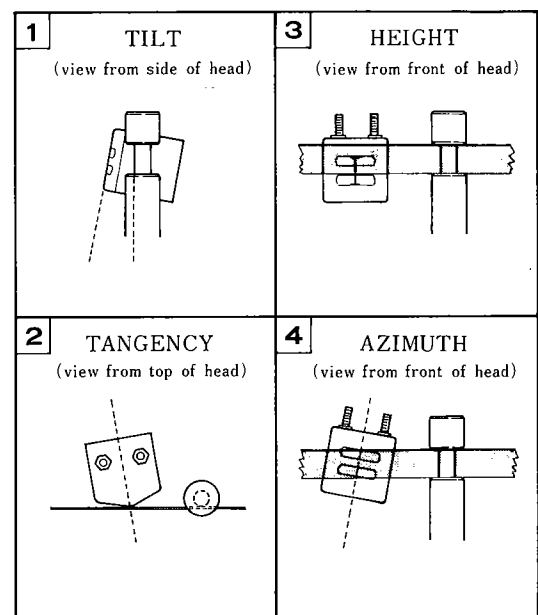

T-619

Fig. 6-3 Head Mis-Alignment - Examples -

7. MEASUREMENT AND ADJUSTMENT

-MECHANICAL-

7-1 PINCH ROLLER PRESSURE

NOTE: Pinch roller pressure is supplied by the pinch roller spring arm and it is most important that the solenoid plunger be fully bottomed before taking pressure measurement.

1. Load tape or block the shut-off arm in the ON position.
2. Attach a suitable spring scale to the pinch roller shaft.
3. Place the deck in the PLAY mode (▶), and holding the spring scale as illustrated, slowly draw it away from the pinch roller.
4. Do not allow the string to rub against the pinch roller.
5. Note the reading on the spring scale at the instant the pinch roller stops rotating.
6. The scale should indicate 2.0 to 2.2 kg (4.4 to 4.8 lbs). Optimum value is 2.1 kg (4.6 lbs).
7. If adjustment is necessary, loosen the 3 screws on the capstan solenoid and position the solenoid for optimum pressure.
8. Adjust solenoid-limit position so that the gap between capstan shaft and pinch roller is approx. 7 mm when solenoid is not actuated. Also make sure pinch roller shaft does not contact edit arm B. Limit is adjusted by loosening the mounting screw (A), then sliding limit until proper position is obtained.

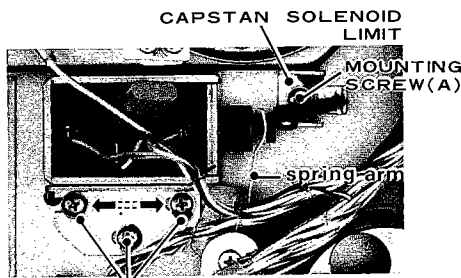

REPOSITION SOLENOID TO OBTAIN OPTIMUM PRESSURE

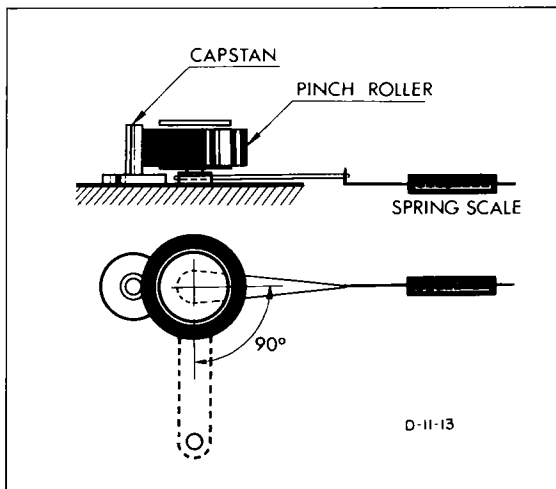

Fig. 7-1 Pressure Measurement and Adj. Locations

7-2 BRAKE TORQUE

The brake torque is actuated mechanically. Pressure is set by the leaf spring force. While making these measurements and adjustments, be careful not to bend the brake bands. As brake torque will change with cleaning, brake drums and brake shoes should be cleaned only when absolutely necessary. If cleaning is required, use TEAC cleaner TZ-261 B. After cleaning, operate the brakes by depressing the play and STOP buttons several times to completely dry out the brakes before performing the following procedure.

NOTE: Brake adjustments are made with NO power connected to the equipment.

1. Place an empty large hub reel on the left reel table, and fasten one end of a 30" length of string to the reel anchor.
2. Wind several turns of string counter clockwise around the hub and attach a suitable spring scale to the free end of the string.
3. Take a reading only when the reel is in steady motion since the force required to overcome static friction will produce a false, excessively high initial reading.
4. The Calculated value should be 800 to 1200 g-cm (11 to 17 oz-in).
5. If adjustment is required, loosen the 2 screws shown and position the brake for optimum torque.
6. The adjustment of the right brake is the same, with the exception that rotation is clockwise. (wind string CLOCKWISE around reel hub)
7. See note at the top of page 11 for explanation of torque measurements.

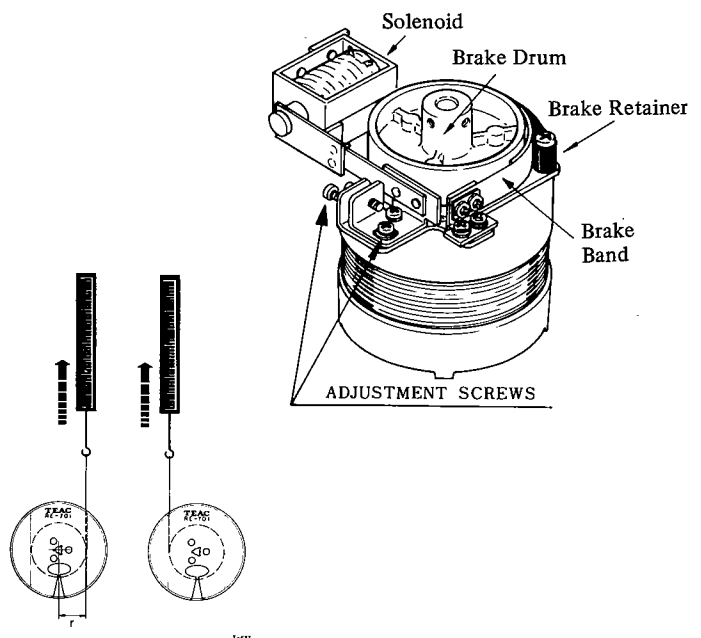

Fig. 7-2 Torque Measurement and Adjustment Location

TORQUE MEASUREMENT PROCEDURE

NOTE: The following torque measurements should be made with a spring scale that is calibrated to read Torque in gram-cm. for a 7" reel with a small reel hub. If the spring scale you are using is calibrated to read Force or Weight in grams the Torque must be calculated using the Formula:

$$\text{Torque (in g}\cdot\text{cm or oz}\cdot\text{in)} = \frac{\text{Weight or Force (in gm. or oz.)} \times \text{radius of hub (in cm or inches)}}{1}$$

If you are using a reel with other than the standard 2.5" or 6.0 cm (approx.) diameter hub, the Torque must be calculated using the same formula and substituting the actual radius and Weight or Force reading.

All Torque and Tension measurements must be made with the automatic shut-off switch (right tension arm) held in the ON position.

Brake Torque Measurement should be made using large hub reel with a hub diameter of 4" or 10.2 cm.

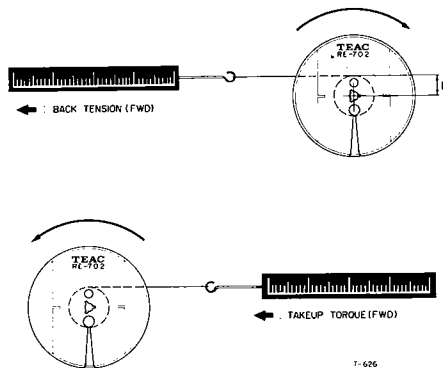

Fig. 7-3 Torque Measurement

7-3 TAKE-UP TORQUE

1. Place the empty reel and attached spring scale on the right reel table.
2. Place the deck in the Forward Play mode.
3. Allow the rotation of the reel to slowly draw the scale toward the hub.
4. Hold the spring scale with enough force to allow a steady reading.
5. The torque calculated value should be approx.:
380 to 400 g-cm (5.3 to 5.6 oz-inch)

7-4 BACK TENSION

1. Place an empty 7" reel with small hub on the left reel table, and fasten one end of a 30" length of string to the reel anchor.
2. Wind several turns of string counter-clockwise around the hub. Attach spring scale to string.
3. Place the deck in the Forward Play mode.
4. Pull the scale away from the reel against the motor torque with a steady, smooth motion.
5. Note the scale reading while it is in steady motion. (The string must not rub the reel flanges)
6. The calculated value should be approx.:
180 to 210 g cm (2.5 to 2.9 oz-inch)

Adjustment Location

If necessary, adjust slider of the resistors until you have the correct scale reading for optimum torque. Refer to adj. location below.

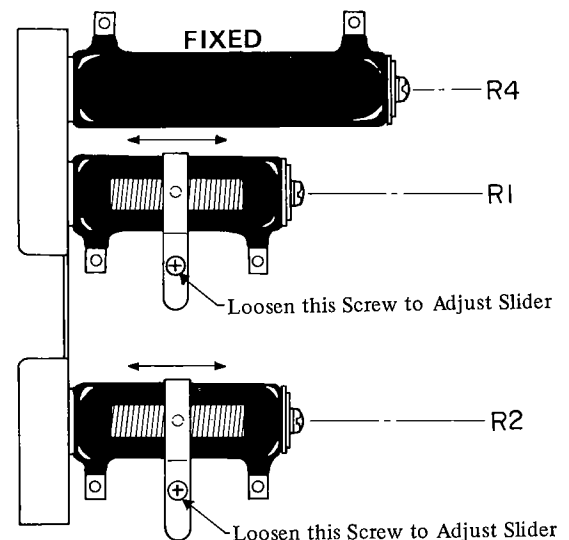

Fig. 7-4 Adjustment Location

R4 . . . for FF REW BACK TENSION (FIXED)

R1 . . . for TAKE-UP TORQUE

R2 . . . for BACK TENSION

7-5 REEL HEIGHT ADJUSTMENT

Reel height adjustment is required only if a motor has been replaced or if tape rubs excessively against the reel. Adjustment is accomplished by FINE ADJ. screw in the reel turntable. Reel turntable height should be checked using standard 7" reels. With a tape threaded on the machine, position the reel height for smooth tape travel. If adjustment is necessary, remove the reel and adjust the screw. Then replace the reel and re-check the adjustment.

7-6 TAPE SPEED

The tape speed should be measured using TEAC flutter free tape, Model YTT-2003 (7-1/2 ips), YTT-2002 (3-3/4 ips). These tapes contain a highly accurate 3,000 Hz tone. Connect a digital frequency counter to either line OUTPUT jack. The indicated frequency should be 3,000 Hz (± 30 Hz or less) for both speeds.

7-7 WOW AND FLUTTER CHECK

NOTE: Before performing this measurement, clean the head and Tape run guides, also check pinch roller pressure, etc.

Use new Test Tape if possible for following adjustments.

Values obtained with different standards of equipment cannot be compared.

PLAYBACK

1. Connect Test equipment to the unit as shown in Fig. 7-5. (Except oscillator).
2. Load TEAC YTT-2003 (for HIGH, 7-1/2 ips) or YTT-2002 (for LOW, 3-3/4 ips) and playback tape.
3. Read the indication on the Wow and Flutter meter.
4. The Wow and Flutter should be
 - 0.18% (RMS) or less for 7-1/2 ips
 - 0.20% (RMS) or less for 3-3/4 ips

OVERALL

1. Connect Test equipment to the unit as shown in Fig. 7-5.
2. Load TEAC YTT-8003 (blank tape) Test Tape on the unit and Record a 3,000 Hz input signal.
3. Rewind and playback the recorded signal.
4. The reading on the Meter should be
 - 0.20% (RMS) or less for 7-1/2 ips
 - 0.25% (RMS) or less for 3-3/4 ips

NOTE: These figures apply to any tape position (such as full take-up reel, full supply reel or about mid-point). Also examine the tape counter ass'y for evenness of operation.

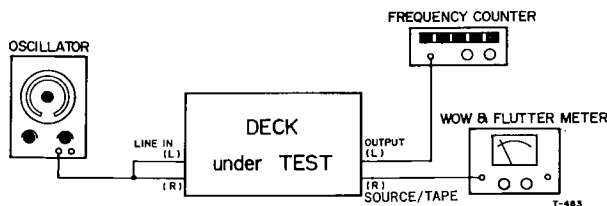

Fig. 7-5 Test Connections for Wow/Flutter and Tape Speed Test

7-8 VOLTAGE AND FREQUENCY CONVERSION

This deck is adjusted to operate on an electric power source of the voltage and frequency specified on the reel tag and packing carton. If it is necessary to change the frequency or voltage requirements of this deck to match your area, use the following procedures.

ALWAYS DISCONNECT POWER LINE CORD BEFORE MAKING THESE CHANGES.

Frequency Conversion: (only Export model)

1. Remove the right side wood panel (4 screws), then the rear/top metal panel (6 screws).
2. Set the power frequency selector slide switch (located next to the capstan motor) to the 50 or 60 position to match the power line frequency in your area.
3. Rotate the center (capstan) motor clockwise with your hand and re-position the belt onto the correct pulley as shown in the motor pulley illustration below. The pulley can be seen by looking through the opening in the side panel. Continue to rotate the motor by hand approximately 10 revolutions to verify belt placement before replacing the side and rear covers.

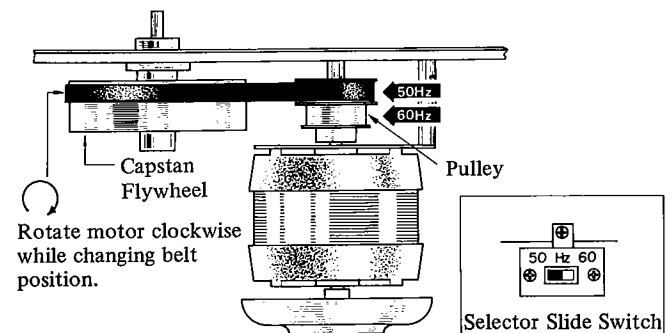

Fig. 7-6 Frequency Conversion

Voltage Conversion: (only Export model)

The deck may be set for 100, 117, 220 or 240 volts. To change the voltage unscrew the fuse in the center of the voltage selector plug. Pull out the plug and reinsert it so the desired voltage shows in the cutout. Reinstall the fuse specified on the label on the rear of the deck.

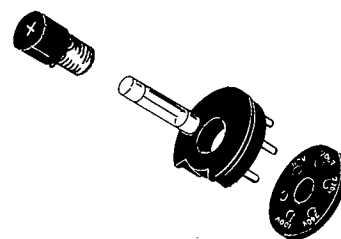

Fig. 7-7 Voltage Conversion

8. MEASUREMENT AND ADJUSTMENT

- ELECTRICAL -

Outlined procedures refer only to FRONT channels, the same procedures also apply to REAR channels.

The ELECTRICAL PROCEDURE is written on the assumption that the procedure will be done completely and in the sequence specified in Fig. 8-1.

Double designated symbol numbers refer to left channel/right channel.

Only FRONT channel adjustments are illustrated, REAR channel adjustments are identical.

8-1 ADJUSTMENT LOCATIONS AND ADJUSTMENT POINTS

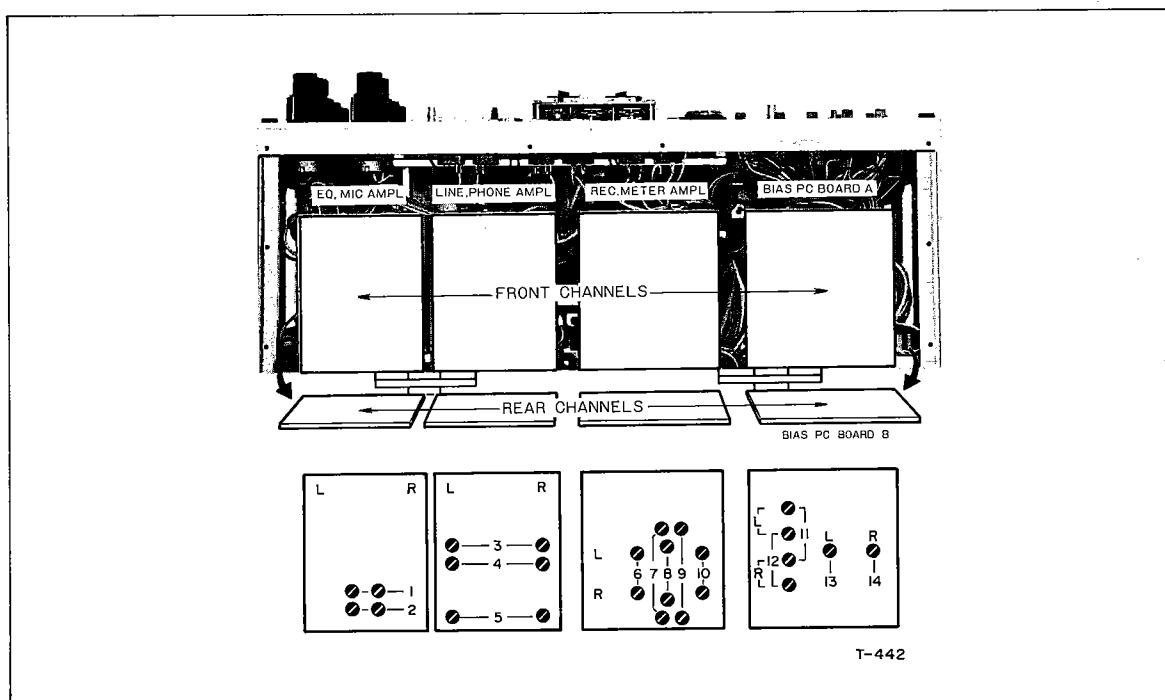

Ref. Nos Abv.	FOR	ADJUSTMENT	
		LEFT	RIGHT
1.	P.B EQ HIGH SPEED	VR101	VR103
2.	P.B EQ LOW SPEED	VR102	VR104
3.	BIAS TRAP	L201	L202
4.	P.B LEVEL	VR201	VR203
5.	P.B METER LEVEL	VR202	VR204
6.	RECORD LEVEL	VR303	VR206
7.	MONITOR LEVEL	VR301	VR304

Ref. Nos Abv.	FOR	ADJUSTMENT	
		LEFT	RIGHT
8.	REC METER LEVEL	VR302	VR305
9.	RECORD EQ	L301	L303
10.	BIAS TRAP	L302	L304
11.	BIAS 2 ADJ	VC501	VC503
12.	BIAS 1 ADJ	VC502	VC504
13.	DUMMY COIL (Fixed)	L-501	
14.	DUMMY COIL (Fixed)		L-502

Ampl PC Board Location and Adjustments Points

8-2 ADJUSTMENT SEQUENCE CHART

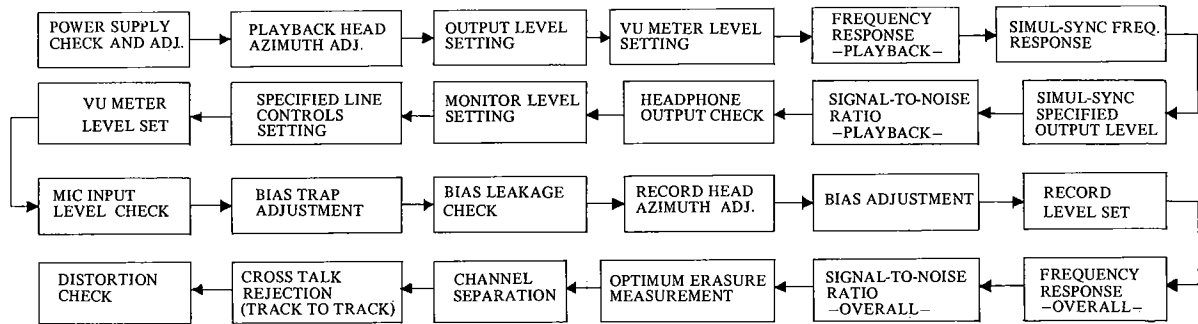

Fig. 8-1 Adjustment Sequence Chart

PLAYBACK PERFORMANCE

8-3 POWER SUPPLY CHECK AND ADJ.

1. Remove wooden panel on left side of the unit for access to the electrical adjustments.
2. Depress power SW to ON.
3. Connect a VTVM between the Power Supply P.C.B. Test Point No. 50 and ground. See Fig. 8-2 below.
4. Adjust VR-1 for +23 V DC.

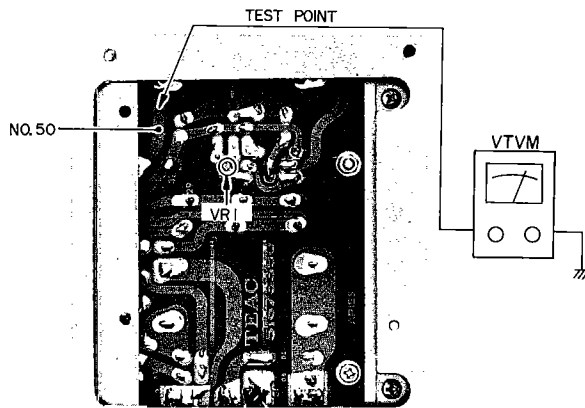

Fig. 8-2 +23 V DC Test Point T-704

1. Connect a VTVM to OUTPUT L1, R3 jacks.
2. Remove the head housing by removing 2 screws.
3. Thread the TEAC YTT-1003 Test Tape on the deck.
4. Play the 16 kHz/-10 dB Test tone in section 2 of the Test Tape.
5. Slowly rotate the azimuth Screw until maximum indication is achieved on VTVM.
6. Connect an oscilloscope to the OUTPUT L1, R3 jacks.
7. Adjust the azimuth screw (if necessary) until the oscilloscope shows that the signals are less than 45° out of phase at 10 kHz signal. Less than 90° for REAR channel at 6.3 kHz. (Check at OUTPUT L2, R4)
8. Secure this screw with a drop of locking paint.

8-4 PLAYBACK HEAD AZIMUTH ADJ.

NOTE: Before proceeding with the following head alignments be sure that heads have been properly mounted as to HEIGHT, TILT and TANGENCY. See page 9.

— Fine Adjustment —

SIMUL-SYINC SW NORMAL
 TAPE SPEED SW HIGH
 PLAY SW 4 CHANNEL
 OUTPUT (L1/R3) SW TAPE

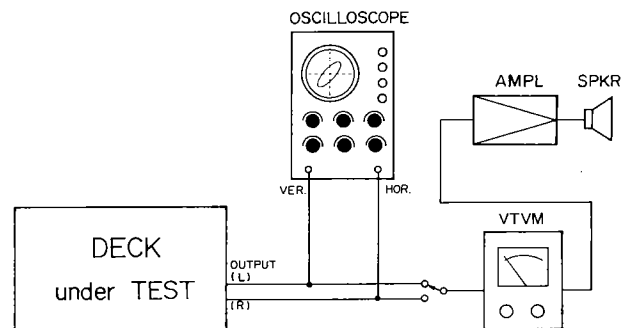

Fig. 8-3 Head Alignment Fine Adjustment Set-up and Test Connections (PLAYBACK) T-389-2

8-5 OUTPUT LEVEL SETTING

— SPECIFIED OUTPUT LEVEL SETTING —

9. Play the 400 Hz/0 dB tone in Section 1 of the Test Tape.
10. Set the reference marks of the OUTPUT controls L1, R3 to the 3 o'clock (8) position.
11. Adjust VR-201/VR-203 for -8 dB (308 mV) at OUTPUT L1, R3 jacks.

— MAXIMUM OUTPUT LEVEL CHECK —

12. Turn the OUTPUT controls L1, R3 fully clockwise and check for -2 dB ± 2 dB (730 mV \sim 488 mV) at OUTPUT L1, R3 jacks.
13. Reduce OUTPUT controls L1, R3 until -8 dB (308 mV) is obtained on the output VTVM.

NOTE: This is the Specified Output level setting. Do not disturb this setting until the remaining adjustments have been completed.

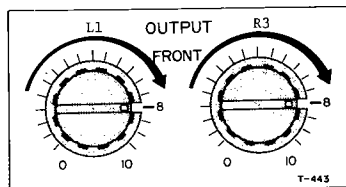

Fig. 8-4 Specified Output Level Setting

8-6 VU METER LEVEL SETTING

14. Adjust VR-202/VR-204 for 0 VU reading on VU Meters.

8-7 FREQUENCY RESPONSE —PLAYBACK—

15. Thread TEAC YTT-1003 on the deck.
16. Play Tape and compare reading on VTVM with the response limits given in Fig. 8-5.
17. If adjustment is required, adjust VR-101/VR-103 for HIGH speed.
18. Change Tape SPEED SW to LOW position.
19. Thread TEAC YTT-1002 on the deck.
20. Repeat Step 16.
21. If adjustment is required, adjust VR-102/VR-104 for LOW speed.

NOTE: If the frequency response does not meet specified response limits, especially at the high-end of the spectrum, head should be checked for accumulated dirt or oxides. If clean, head azimuth must be readjusted.

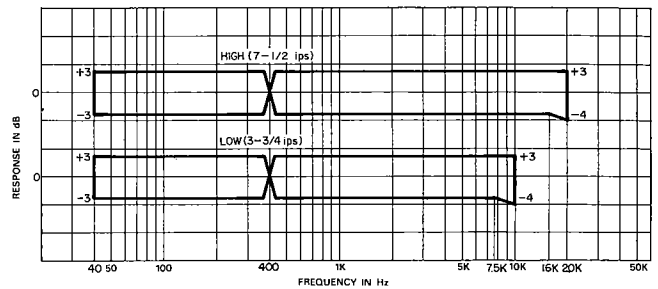

Fig. 8-5 Frequency Response — PLAYBACK —

8-8 SIMUL-SYNC FREQ. RESPONSE

SIMUL — SYNC SW SIMUL-SYNC

22. HIGH (7-1/2 ips) and LOW (3-3/4 ips) response should be identical Frequency response in SIMUL-SYNC function as measured in NORMAL operation.
23. After Test, place SIMUL-SYNC SW to NORMAL position.

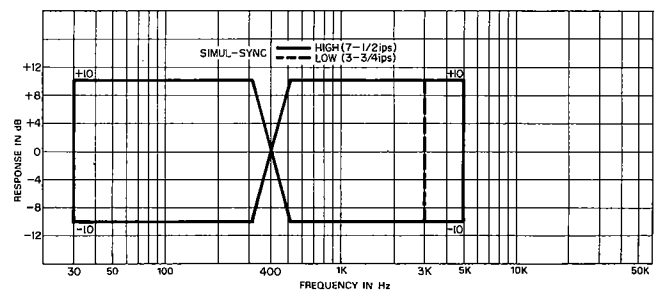

Fig. 8-6 Simul-Sync Freq. Response

8-9 SIMUL-SYNC SPECIFIED OUTPUT LEVEL

1. With controls set as described above Section 8-5 (Specified Output Level Setting).
2. Place the SIMUL-SYNC SW from NORMAL to SIMUL-SYNC position.
3. Check for level reading -9 dB ± 4 dB. (173 mV -435 mV)

8-10 SIGNAL-TO-NOISE RATIO —PLAYBACK—

1. OUTPUT controls L1, R3 should be at the Specified Output level settings.
2. Thread a YTT-1003 on the unit leaving the tape outside the capstan and pinch roller.
3. Hold the play supply reel stationary and depress the play (\blacktriangleright) button.
4. The VTVM connected to the OUTPUT L1, R3 jacks should indicate readings listed below.

HIGH (7-1/2 ips)	48 dB
LOW (3-3/4 ips)	46 dB

8-11 HEADPHONE OUTPUT CHECK

1. Connect an 8 ohm non-inductive resistor across the headphone (PHONE) jack.
2. Connect VTVM across the resistor. VTVM should indicate -24 dB ± 2 dB (61.5 mV \sim 38.8 mV).

8-12 MONITOR LEVEL SETTING

OUTPUT (L1, R3) SW SOURCE

1. Turn LINE controls L1, R3 fully clockwise.
2. Apply a 400 Hz -18 dB (97 mV) signal from AF oscillator to LINE IN L1, R3 jacks.
3. Adjust VR-301/VR-304 for -8 dB (308 mV) at the OUTPUT L1, R3 jacks.

8-15 MIC INPUT LEVEL CHECK

This is check only. No adjustment is to be made.

1. Decrease LINE controls L1, R3 to minimum position.
2. Set MIC controls L1, R3 fully clockwise.
3. Apply a 400 Hz signal at -70 dB (0.244 mV) to the MIC input L1, R3 jacks.
4. Check for -8 dB (308 mV) level at OUTPUT L1, R3 jacks.
5. With -8 dB (308 mV) at OUTPUT L1, R3 jacks, MIC input level should be -70 dB \pm 2 dB (0.194 mV ~ 0.308 mV).
6. Return MIC controls fully counter clockwise to prevent noise insertion during following steps.
7. Reset the LINE controls L1, R3, to the "Specified setting".

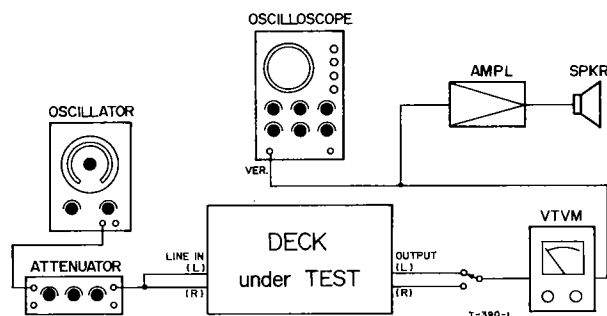

Fig. 8-7 Test Connections for Monitor Check

8-13 SPECIFIED LINE CONTROLS SETTING

4. Apply a 400 Hz -8 dB (308 mV) signal from AF oscillator to LINE IN L1, R3 jacks.
5. Adjust LINE controls L1, R3 for -8 dB (308 mV) at OUTPUT L1, R3 jacks.

NOTE: At this point both the line controls (L1, R3) and OUTPUT controls (L1, R3) are at the "Specified setting". Do not move these controls unless instructed in this procedure to do so.

The accuracy of many of the following adjustments and readings depends on these controls being at the "Specified setting".

8-14 VU METER LEVEL SET

6. Check VU Meters for 0 VU indication.
7. Adjust VR-302/VR-305 for 0 VU, if necessary.

8-16 BIAS TRAP ADJUSTMENT

OUTPUT (L1, R3) SW TAPE
 RECORD MODE (L1, R3) SW ON
 BIAS and EQ SW 1
 Select REC PAUSE mode

1. Remove all input signals.
2. Connect a VTVM or oscilloscope from ground to the junction of L-302 and C-312 (L-ch) and from ground to the junction of L-304 and C-330 (R-ch). See Fig. 8-8.
3. Adjust L-302 (L-ch) and L-304 (R-ch) for minimum reading on scope or VTVM.
 Use Plastic alignment tool.

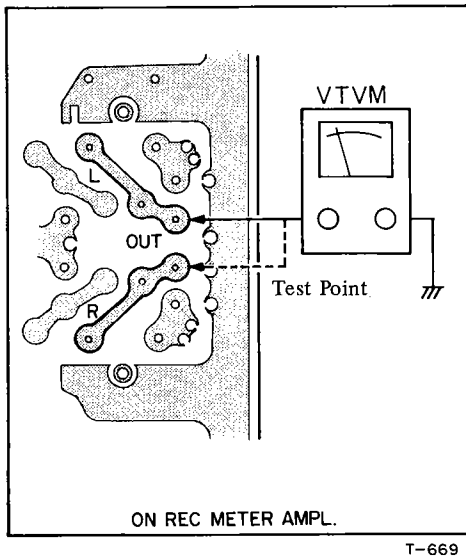

Fig. 8-8 Bias Trap Test Point

8-17 BIAS LEAKAGE CHECK

4. Adjust L-201/202 (on LINE, PHONE AMPL.) for minimum bias leakage reading at OUTPUT jacks.
 Spec. -40 dB (7.75 mV) or less.

8-18 RECORD HEAD AZIMUTH ADJ.

Tape SPEED SW LOW (3-3/4 ips)

NOTE: The effect of turning the azimuth screw will register on the VTVM. A slight delay will be noticed. Therefore, the screw must be rotated slightly with a pause to see the effect.

—Fine Adjustment—

5. Connect a VTVM to the OUTPUT L1, R3 jack and an AF oscillator to the LINE IN L1, R3 jack.
 Set the oscillator to 10 kHz at -18 dB (97 mV).
6. Begin recording (Depress REC and PLAY buttons).
7. While recording, adjust the azimuth screw for maximum reading on the VTVM.

NOTE: It is absolutely essential to accomplish the above adjustment before performing the following adj. to avoid phase errors greater than 45° (90° on REAR channels).

8. Sweep the oscillator frequency from 50 Hz to 10 kHz and check that phase difference between channel is 45° or less on Front Channels. (90° or less on Rear channels).
9. Secure the screw with insulating locking paint.

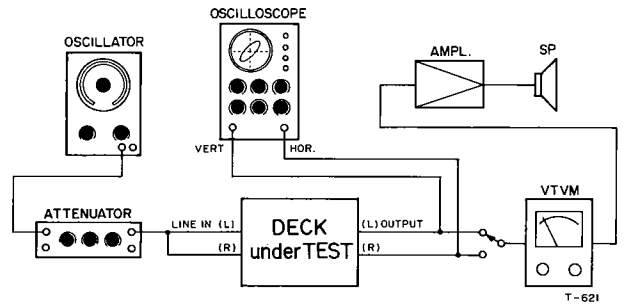

Fig. 8-9 Test Connection for Recording Check

8-19 BIAS ADJUSTMENT

Be sure the Bias Trap has been adjusted per section 8-15, 8-16 before proceeding.

Tape SPEED SW LOW
 BIAS and EQ SW 1

10. Apply 7 kHz signal at -18 dB (97 mV) to the LINE IN L1, R3 jacks.
11. While recording on the YTT-8003 Test Tape, adjust capacitor VC-502/VC-504 for peak reading on the VTVM, then turn the capacitor clockwise until a decrease of 2.5 dB from the peak is obtained. Limit should be 2~3 dB "over-bias".

BIAS and EQ SW 2

12. While recording on the YTT-8023 Test Tape.
13. Adjust VC-501/VC-503 for same indication as step 11.
14. Repeat the above procedure for the REAR Channels.

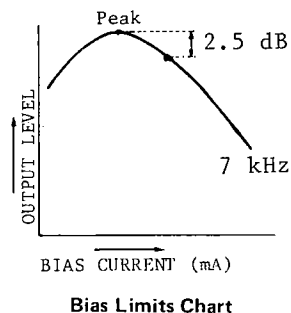

8-20 RECORD LEVEL SET

Tape SPEED SW HIGH

14. Apply 400 Hz signal at -8 dB (308 mV) to the LINE IN L1, R3 jacks.
Be sure the Line and Output controls are still at their previously set positions.
15. Begin recording.
16. Adjust VR-303/VR-306 for -8 dB (308 mV) at OUTPUT L1, R3 jacks.

-BIAS and EQ SW at 2 position Level Check-

17. Repeat step 14. Use TEAC YTT-8023 tape.
18. Check for -8 dB \pm 1 dB (345 mV \sim 274 mV) at OUTPUT L1, R3 jacks.

8-21 FREQUENCY RESPONSE -OVERALL-

NOTE: To avoid saturation of the tape these checks should be made at least 20 dB below the specified input level.

Any Bias signal feeding into the test equipment should be filtered out by adjusting the external Bias Trap.

BIAS and EQ SW 1

Tape SPEED SW LOW

19. Apply signal swept from 40 Hz to 16 kHz, -28 dB (30.8 mV) to the LINE IN L1, R3 jacks and record on a blank TEAC YTT-8003 Test Tape.
20. During recording, monitor the Tape signal and adjust equalization L-301/L-303 for readings within the Response Limits charts. See Fig. 8-10 below.
21. Change the Tape SPEED SW to HIGH position.
22. Apply signal swept from 40 Hz to 20 kHz, -28 dB (30.8 mV) and while monitoring the off-the-Tape signal check for readings within the Response Limits charts. See Fig. 8-10 below.

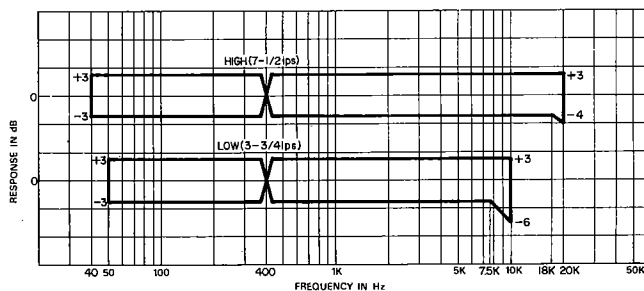

Fig. 8-10 Frequency Response - OVERALL - 1

BIAS and EQ SW 2

23. Apply signals swept from 40 Hz to 10 kHz to the unit while recording on a blank TEAC YTT-8023 Test Tape.
24. Repeat the above procedure for HIGH, using a signal swept from 40 Hz to 18 kHz. Refer to Response Limits in Fig. 8-11 below.

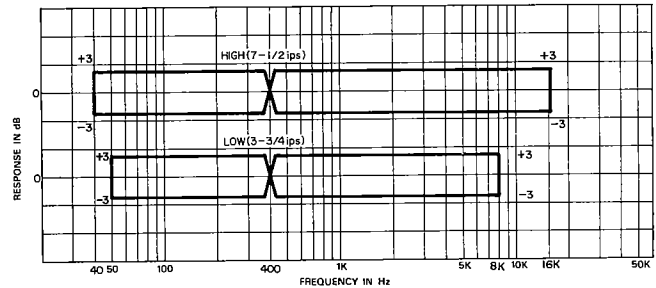

Fig. 8-11 Frequency Response - OVERALL - 2

NOTE: If the response is not uniform, the head should be cleaned of accumulated oxide and dirt. Then repeat the Bias adjustment procedure.

8-22 SIGNAL-TO-NOISE RATIO -OVERALL-

1. Output and Line controls should be at the specified positions.
2. Remove the AF oscillator from the LINE IN L1, R3 jacks.
3. Place the deck in the Record mode with "no signal" applied. Note the point on the index counter where recording begins.
4. Rewind the tape (YTT-8003) to the beginning point and play it back.
5. The noise level as indicated on the VTVM should be readings listed below.

HIGH (7-1/2 ips) 47 dB
LOW (3-3/4 ips) 45 dB

8-23 OPTIMUM ERASURE MEASUREMENT

Tape SPEED SW HIGH

1. Thread the TEAC YTT-8003 Test Tape on the unit.
2. Apply a 1 kHz signal at 10 dB above the operating level of -8 dB (308 mV) to the LINE IN L1, R3 jack.
3. Make a 30 seconds recording of the above signal while reading and noting the level of output, then rewind to beginning of this recording.
4. Disconnect the 1 kHz signal source (AF oscillator) from the LINE IN L1, R3 jack.
5. Connect a VTVM to the OUTPUT L1, R3 jack, through a 1 kHz Narrow Band Pass Filter.
6. Put deck in the Record mode and "record" (erase) over this previous recording, then rewind to beginning again.
7. Put deck in Play mode and monitor the output on the VTVM.
8. Difference in output level, between the 1 kHz signal and the "no signal" section level should be more than 65 dB.

NOTE: Filter loss should be considered.

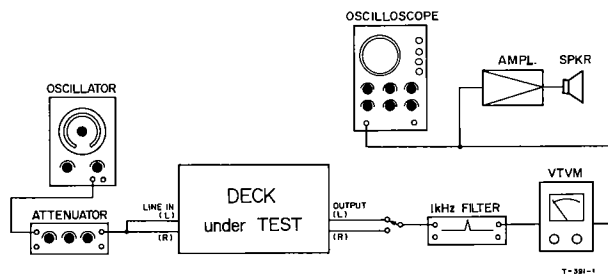

Fig. 8-12 Test Connections for Erase measurement

8-24 CHANNEL SEPARATION

1. Be sure tape is completely bulk erased prior to doing these checks.
2. Apply a 1 kHz signal at -8 dB (308 mV) to track 1.
3. Place deck in Record mode.
4. While recording measure the OUTPUT on channel 3 with VTVM connected through a 1 kHz Band Pass Filter. Level should be 45 dB or less.

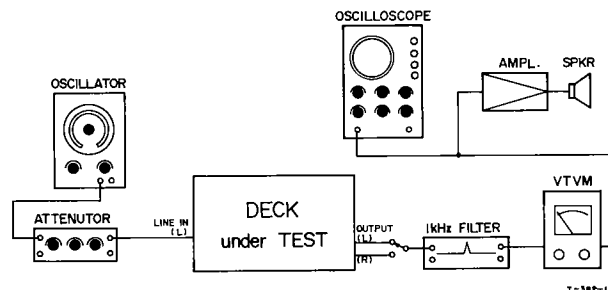

Fig. 8-13 Test Connections for Channel separation check

8-25 CROSS TALK REJECTION (TRACK TO TRACK)

1. Apply a 125 Hz signal at -8 dB (308 mV) to track 1 and 3 (No signal input to tracks 2 and 4).
2. Make a 30 second recording of the 125 Hz signal.
3. Rewind the tape to the beginning of the recording.
4. Play back the tape and measure the OUTPUT from track 2 or 4.
5. Apply the 125 Hz signal to track 2 and 4. (No signal input to track 1 and 3).
6. Make another recording for about 30 seconds.
7. Rewind the tape to the beginning of this recording.
8. Play back the tape and measure the OUTPUT from track 1 or 3.
9. Level measured in steps 4 and 8 must be -35 dB or more.

8-26 DISTORTION CHECK

Tape SPEED SW . HIGH (7-1/2 ips)
BIAS and EQ SW 1

1. Thread the TEAC YTT-8003 Test Tape on the unit.
2. Apply a 1 kHz signal to LINE IN jacks.
3. Place the deck in the record mode for about 10 seconds. Rewind and play this recorded section of the tape.
4. Read the indicated value on the distortion analyzer.
5. The distortion factor should be 1.5 % or less.

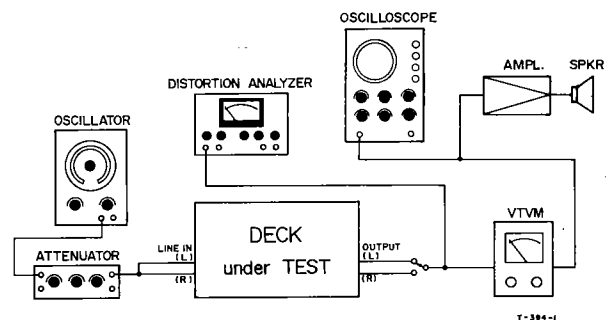

Fig. 8-14 Test Connections for Distortion check

9. TROUBLE-SHOOTING

NOTE: The following guide lists specific difficulties that could occur in the A-2340SX. Several possible causes are listed for each malfunction. Visually inspect the unit for any damage such as broken or burned components or wiring, loose connections, etc.

MALFUNCTION	POSSIBLE SOURCE OF TROUBLE	CORRECTIVE PROCEDURE
Capstan fails to turn	Belt off or slipping, line fuse (F-1), safety switch (S2), speed select switch (S12).	Refer to schematic diagram and repair or replace the defective components.
Pinch roller fails to contact capstan in play mode	AC voltage Selector position, stop switch (S4), rewind relay (K-3), capstan solenoid.	The normal DC resistance of the capstan solenoid is 1.3k ohms.
Right reel does not rotate in the play mode	Resistor (R1), rewind relay (K-3), capacitor (C-5)	Refer to schematic diagram and repair or replace the defective components.
Left reel does not rotate in play mode	Resistor (R2), rewind relay (K-3), capacitor (C-20)	Refer to schematic diagram and repair or replace the defective components.
Left reel operates with low torque	Resistor (R-6), safety switch (S2)	Repair or replace defective components.
Both reel motors fail to operate	Operating relay (K1)	Clean contacts on or replace relay.
Recorder does not operate in forward play	Remote control jumper plug missing or loose, stop switch (S14), operate relay (K1), brake solenoid, diode (DC 24V)	Normal DC resistance of the brake solenoid is 1.3k ohms. Refer to schematic diagram and repair or replace the defective components.
Playback noise or hum	Faulty connections, head selector switch, faulty playback head, faulty amplifier	Repair or replace defective components.
Noise or hum during record	Magnetized head, faulty connections, mic level set to maximum, faulty record amplifier, record relay (K501 or K601) on BIAS P.C. BOARD	Demagnetize and clean head, repair or replace defective components.
Wow & flutter	Defective tape, dirty or defective pinch roller, oily or defective belt, reel motor tension.	Clean or replace defective components. Adjust motor tension.
Incorrect tape speed	Drive belt in wrong position. Incorrect Pinch Roller Pressure	Reposition drive belt. Adjust pinch roller pressure.
Brake does not release	Defective brake solenoid	The D.C. resistance of the brake solenoid should be 1.3k ohms. Replace solenoid.
Fast forward or rewind mode inoperative	Rewind relay (K-3)	Refer to schematic diagram and repair or replace the defective components.
No record and/or no erase	Record head dirty, erase head dirty, operate relay (K1), record switch (S8), record relay (K501 or K601), record amplifier, bias oscillator, record head, erase head.	Refer to schematic diagram and repair or replace the defective components. For record amplifier troubleshooting refer to voltage chart.
No playback	Playback head dirty, amplifier to deck connections, monitor switch (S712), playback amplifier.	Refer to playback amplifier voltage chart.

10. SERVICING AND MAINTENANCE

10-1 CLEANING:

TEAC TZ-261A for Head cleaning and TZ-161B for Rubber cleaning should be used. Use for following places.

TZ-261A	TZ-261B
Pinch roller rubber	Motor pulley
Capstan belt	Heads
Counter belt	Capstan shaft
Brake drums	Tape run guides

10-2 LUBRICATION:

Under normal operating conditions, lubrication is required only once each year. Before lubricating, clean the drive belt and drive pulley... etc. Operate the deck for 30 minutes to 1 hour immediately prior to oiling. After oiling, keep the deck in the upright position for 3 to 4 hours to allow thorough absorption of the oil.

Approximately once each year or after 2000 hours of use, apply TEAC TZ-255 Lubricating Oil to the following places only;

- Pinch roller shaft 1 drop
- Capstan shaft 2 drops
(Remove the dust cap for access to the oil pit)
- Capstan motor and reel motors 0.5 cc
(Maximum to fill oiling each tube)

NOTE: Apply 3 or 4 drops at a time through the oiling tube. The oil level can be seen to drop as the felt material in the motor bearings absorb oil. When the level ceases to drop, no more oil is needed. Do not attempt to force oil into the motor nor exceed the maximum.

Excessive oiling will scatter oil inside the deck. This oil will cause drive belt slippage and other difficulties. Check for slippage and clean all parts inside the deck before operating after lubrication. Check for oil emission after operation and before returning deck to the customer.

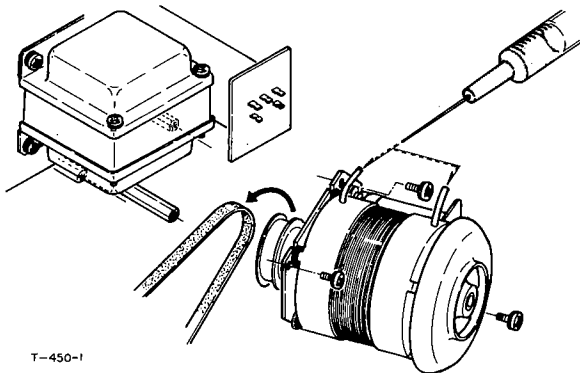
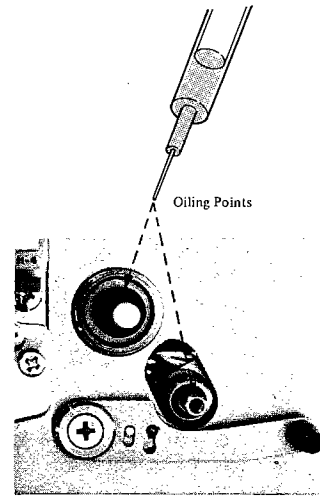

Fig. 10-1 Capstan Motor Oiling Point



T-703

Fig. 10-2 Capstan Shaft and Pinch Roller Shaft Oiling Points

10-3 TEAC MAINTENANCE FLUIDS



Fig. 10-3 TZ-255 Oil kit



Fig. 10-3 TZ-261 Tape Recorder Kit

10-4 DEMAGNETIZATION OF HEADS

If the record or Playback heads becomes magnetized, noise will increase and tonal fidelity will deteriorate. For this reason it is advisable to use non-magnetic tools when working near the heads. If the heads have had any contact with current or magnetized metal parts, demagnetize them with a TEAC E-3 eraser or Equivalent.

11. SIMPLIFIED SCHEMATIC

with level indications

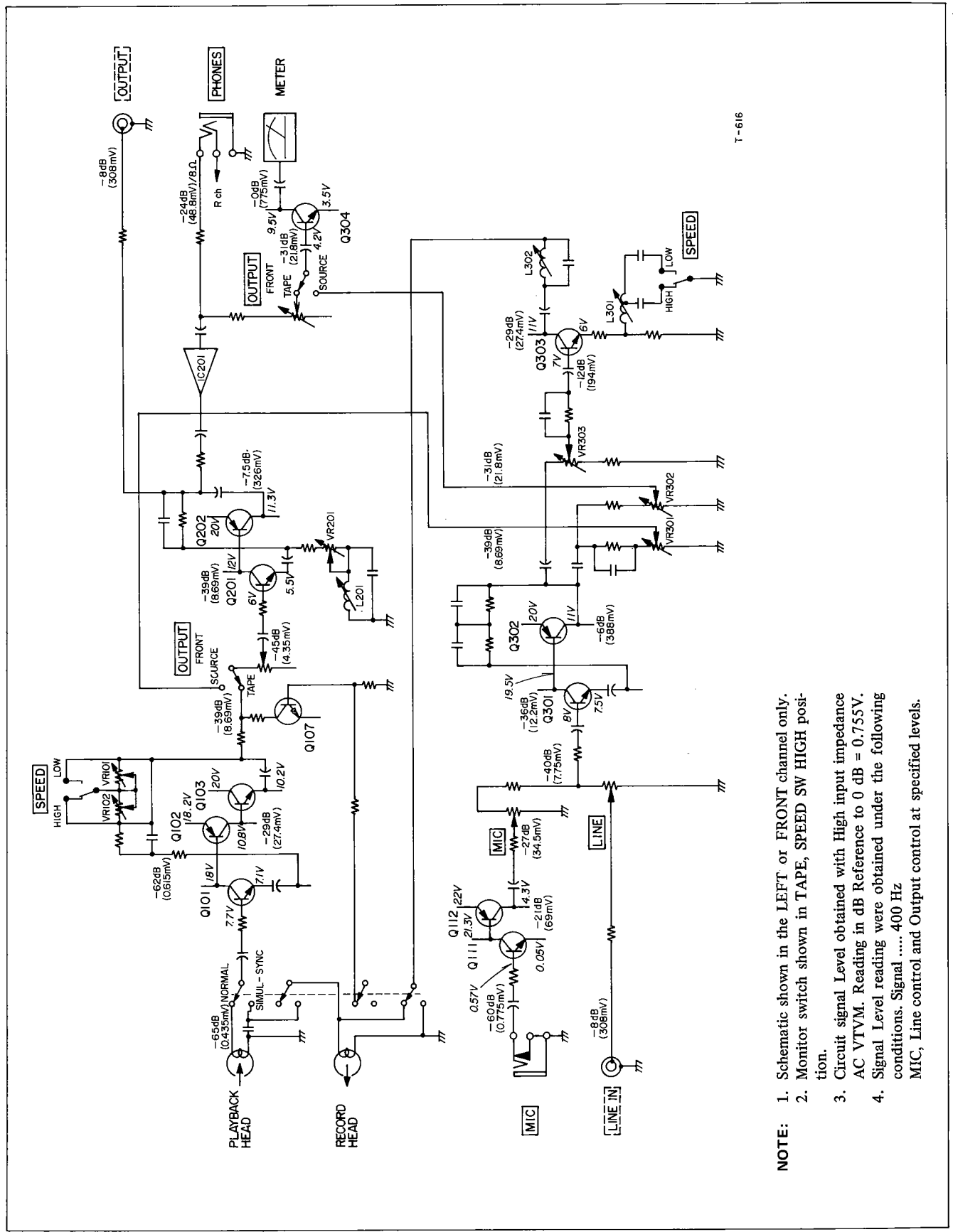

T-616

- NOTE:**
1. Schematic shown in the LEFT or FRONT channel only.
 2. Monitor switch shown in TAPE, SPEED SW HIGH position.
 3. Circuit signal Level obtained with High input impedance AC VTVM. Reading in dB Reference to 0 dB = 0.755V.
 4. Signal Level reading were obtained under the following conditions. Signal 400 Hz
- MIC, Line control and Output control at specified levels.

TEAC®

PARTS LIST

A-2340SX

4-Channel Stereo Tape Deck



TABLE OF CONTENTS

1. EXPLODED VIEWS AND PARTS LIST

1-1 MAIN CHASSIS GROUP	2, 3
1-2 MOTOR CHASSIS GROUP	4, 5
1-3 FRONT PANEL	6, 7
1-4 REAR PANEL	8, 9

2. PC BOARD SECTION (Diagram and Parts List)

2-1 EQ/MIC AMPLIFIER	10, 15
2-2 LINE/PHONE AMPLIFIER	10, 15
2-3 REC/METER AMPLIFIER	11, 16
2-4 SOLENOIDE CONTROL RELAY	11, 17
2-5 CONTROL PC BOARD	12, 17
2-6 POWER SUPPLY PC BOARD	13, 17
2-7 OSCILLATOR PC BOARD	13, 17
2-8 BIAS PC BOARD-A	14, 18
2-9 BIAS PC BOARD-B	14, 18

3. INCLUDED ACCESSORIES

18

PARTS ORDERING INFORMATION

Spare parts are available through your nearest TEAC Authorized Service Center or directly from the TEAC office, the address of which is written on the back cover. When ordering parts, always include the following information:

- | | |
|--------------|--------------------|
| 1. MODEL | 4. DESCRIPTION |
| 2. REF. NO. | 5. UNIT SERIAL NO. |
| 3. PARTS NO. | 6. MANUAL CODE NO. |

NOTICE REGARDING PARTS ORDERS

1. Do not order by only REF. NO.
2. In some instances, individual minor parts are not available. In such a case, the entire assembly including the part requested will be sent to you.
3. Parts are identical between the different models with the exceptions as coded by the designations in the REMARKS column.
4. PC Boards shown viewed from foil side.
5. Parts marked with *require longer delivery time than regular parts.

TEAC CORPORATION

1. EXPLODED VIEWS AND PARTS LIST

1-1. MAIN CHASSIS GROUP

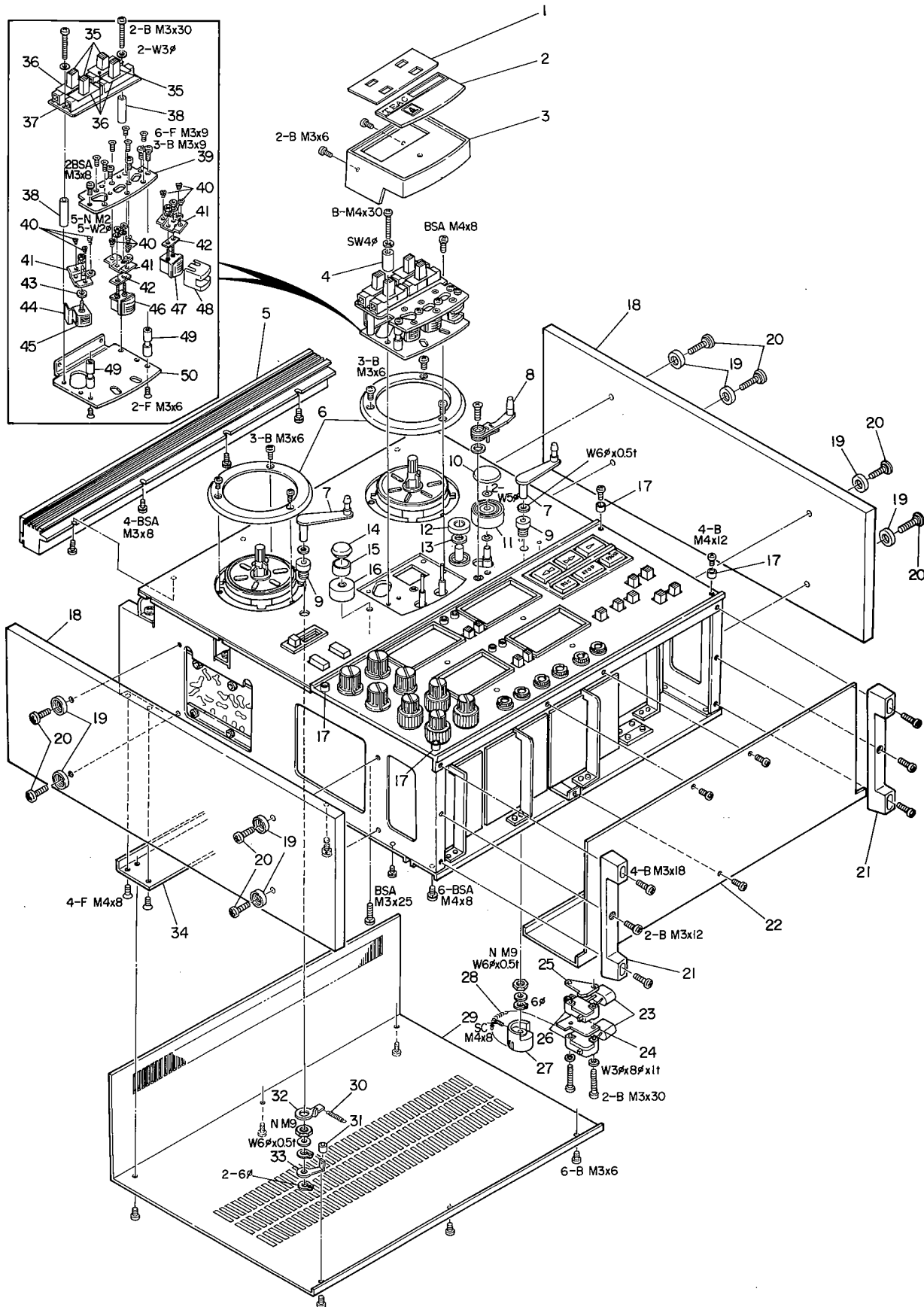

REF. NO.	PARTS NO.	DESCRIPTION	REMARKS
1 - 1	*55542111	Plate, Head Housing	
1 - 2	*55547470	Plate, Name	
1 - 3	*50136292	Head Housing	
1 - 4	*55403520	Sleeve, Head Assy Mtg Screw	
1 - 5	*50112980	Grill Assy, Top	
1 - 6	*50161941	Protector, Reel	
1 - 7	50180432	Arm Assy, Tension	
1 - 8	*55043410	Arm Assy, Cue	
1 - 9	*50182701	Bushing, Arm; A	
1 - 10	50142180	Cap, Pinch Roller	
1 - 11	50141751	Pinch Roller	
1 - 12	50123971	Cap, Dust	
1 - 13	*50123900	Sealing, Oil	
1 - 14	*50123911	Cap, Guide Ring	
1 - 15	*50123931	Ring, Guide	
1 - 16	*50123921	Guide Ring Base	
1 - 17	*50277111	Washer, Trim	
1 - 18	55430100	Sideboard	
1 - 19	55342780	Washer, Trim, Sideboard	
1 - 20	55810430	Screw, Sideboard	
1 - 21	*50277980	Leg, Case	
1 - 22	*55043380	Cover Assy, Bottom	
1 - 23	50529050	Spark Killer, 0.1 mfd + 120 ohm 400V	
1 - 24	*50183932	Spacer, Insulator Paper	
1 - 25	50182731	Limit Stop, Tension Arm	
1 - 26	51300010	Switch, Micro	
1 - 27	*50183921	Drum, Tension Arm	
1 - 28	*55203110	Spring, Right Tension	
1 - 29	*55530310	Cover, Rear	
1 - 30	50221110	Spring, B	
1 - 31	*50276990	Collar, Rubber	
1 - 32	*50276870	Anchor, Spring; Left	
1 - 33	*50182750	Travel Limiter, Tension Arm	
1 - 34	*50235312	Angle, Rear Cover	
1 - 35	50136321	Cap, Slide Switch; B	
1 - 36	*55505330	Mask, Slide Switch	
1 - 37	*51681731	PC Board Assy, Simul-Sync	
	50444700	Switch, Slide	Part of 1 - 37
1 - 38	*55403510	Spacer, Simul-Sync Switch Assy	
1 - 39	*55505120	Plate, Head Base	
1 - 40	50220500	Spring, Head; B	
1 - 41	*50134371	Plate, Head	
1 - 42	55501511	Spacer, Head; A	
1 - 43	*50136591	Spacer, Erase Head	
1 - 44	*55505150	Bracket, Head Protector; B	
1 - 45	50664110	Head, Erase	
1 - 46	50664250	Head, Record (4T-4CH)	
1 - 47	50664570	Head, Playback (4T-4CH)	
1 - 48	*50133891	Head Shield, A	
1 - 49	*50182672	Guide, Tape	
1 - 50	55505320	Plate, Housing Base	

REF. NO.	PARTS NO.	DESCRIPTION	REF. NO.	PARTS NO.	DESCRIPTION
2 - 1	50173561	Drum, Brake	2 - 39	*50253890	Button, Switch
2 - 2	55043100	Band Assy, Brake; F	2 - 40	*50237470	Brakcet, Switch Assy
2 - 3	*50170150	Plate, Band Pressure	2 - 41	*50332380	Bracket, Slide Switch
2 - 4	50171382	Felt, Brake	2 - 42	50444610	Switch, Slide
2 - 5	*50170160	Bracket, Brake Band	2 - 43	*50152453	Plate, Lifter
2 - 6	50616770	Solenoid Assy, Brake	2 - 44	50221100	Spring, Lifter; A
2 - 7	*50172550	Retainer, Brake	2 - 45	*50152501	Shaft, Lifter Arm
2 - 8	*50173650	Plate, Reel Motor	2 - 46	50150252	Arm Assy, Lifter; B
2 - 9	71041043	Motor, Reel	2 - 47	50150242	Arm Assy, Lifter; A
2 - 10	50173661	Band Assy, Brake; C	2 - 48	*50162980	Escutcheon, Counter
2 - 11	*50173690	Plate, Micro Switch	2 - 49	50123984	Fan, Motor Cooling
2 - 12	*50332680	Spacer, Insulator Paper	2 - 50	50701341	Motor, Capstan
2 - 13	50446180	Switch, Micro	2 - 51	*50123860	Stand-off, Flywheel
2 - 14	50549920	Metalized Mylar, 0.1 mfd 400V	2 - 52	*50277233	Plate, Thrust
2 - 15	*51520860	Transformer, Power U.S.A., CANADA	2 - 53	50123830	Belt, Capstan Drive
	*51520850	Transformer, Power GENERAL EXPORT	2 - 54	50125121	Pulley, Motor U.S.A., CANADA
2 - 16	*55340410	Clamp, Wire; A		50124003	Pulley, Motor GENERAL EXPORT
2 - 17	*50236650	Plate, Transformer U.S.A., CANADA	2 - 55	*50237520	Plate, Capstan Motor
	*55547650	Plate, Transformer GENERAL EXPORT	2 - 56	*50706211	Cushion, Rubber; Motor
2 - 18	*50545940	Capacitor, MP; (3.9 + 0.9) mfd	2 - 57	*50332790	Spacer, Rubber Cushion
2 - 19	*50162760	Spacer, Rubber Cushion	2 - 58	*50275690	Cushion, Rubber
2 - 20	*50162960	Cushion, Rubber	2 - 59	*50141842	Limit Stop, Pinch Roller
2 - 21	*50491582	PC Board Assy, Solenoid Control Relay	2 - 60	50220441	Spring, Return
		U.S.A., CANADA	2 - 61	*50123850	Stand-off, Capstan Motor
	*50491680	PC Board Assy, Solenoid Control Relay	2 - 62	*51681721	PC Board Assy, Terminal
		GENERAL EXPORT	2 - 63	*55505090	Bracket, PC Board
2 - 22	*50332573	Bracket, PC Board	2 - 64	*50123802	Flywheel, Capstan
2 - 23	*50161950	Stand-off, Reel Motor	2 - 65	50120441	Capstan Assy
2 - 24	*50237461	Chassis, Reel Motor	2 - 66	*50142190	Plate, Arm Support
2 - 25	50160334	Reel Table Assy	2 - 67	*50524110	Resistor, Wire Wound; 1.0k ohm 30H
2 - 26	50332560	Belt, Counter	2 - 68	*50524310	Resistor, Wire Wound; 150 ohm 20HA
2 - 27	*51683391	PC Board Assy, Power Supply	2 - 69	*50522370	Resistor, Wire Wound; 700 ohm 20HA
2 - 28	*55547430	Plate, PC Board	2 - 70	*50330111	Bracket, Resistor
2 - 29	*50332520	Bracket, Counter	2 - 71	50221152	Spring, Pressure
2 - 30	50585140	Counter, Index	2 - 72	50616760	Solenoid Assy, Pinch Roller
2 - 31	*50332950	Washer, Insulating Part of 2 - 27	2 - 73	50422570	Diode, S1B01-06
2 - 32	50424620	Transistor, 2SD235 (Y) Part of 2 - 27	2 - 74	*50140237	Arm Assy, Pinch Roller
2 - 33	*50332910	Sheet, Insul.; Mylar Part of 2 - 27	2 - 75	*50141821	Shaft, Roller Arm
2 - 34	*55021150	Chassis Assy, Side; Left	2 - 76	*50114277	Panel, Chassis
2 - 35	*50491401	PC Board Assy; Terminal	2 - 77	*55521280	Panel, Trim
2 - 36	50545650	Capacitor, MP; (2 + 0.8) mfd 250V	2 - 78	*50113981	Chassis Assy, Side; Right
2 - 37	*50332671	Spacer, Insulator	2 - 79	*50277151	Plate, Thrust
2 - 38	50443902	Switch Assy			

1-3. FRONT PANEL

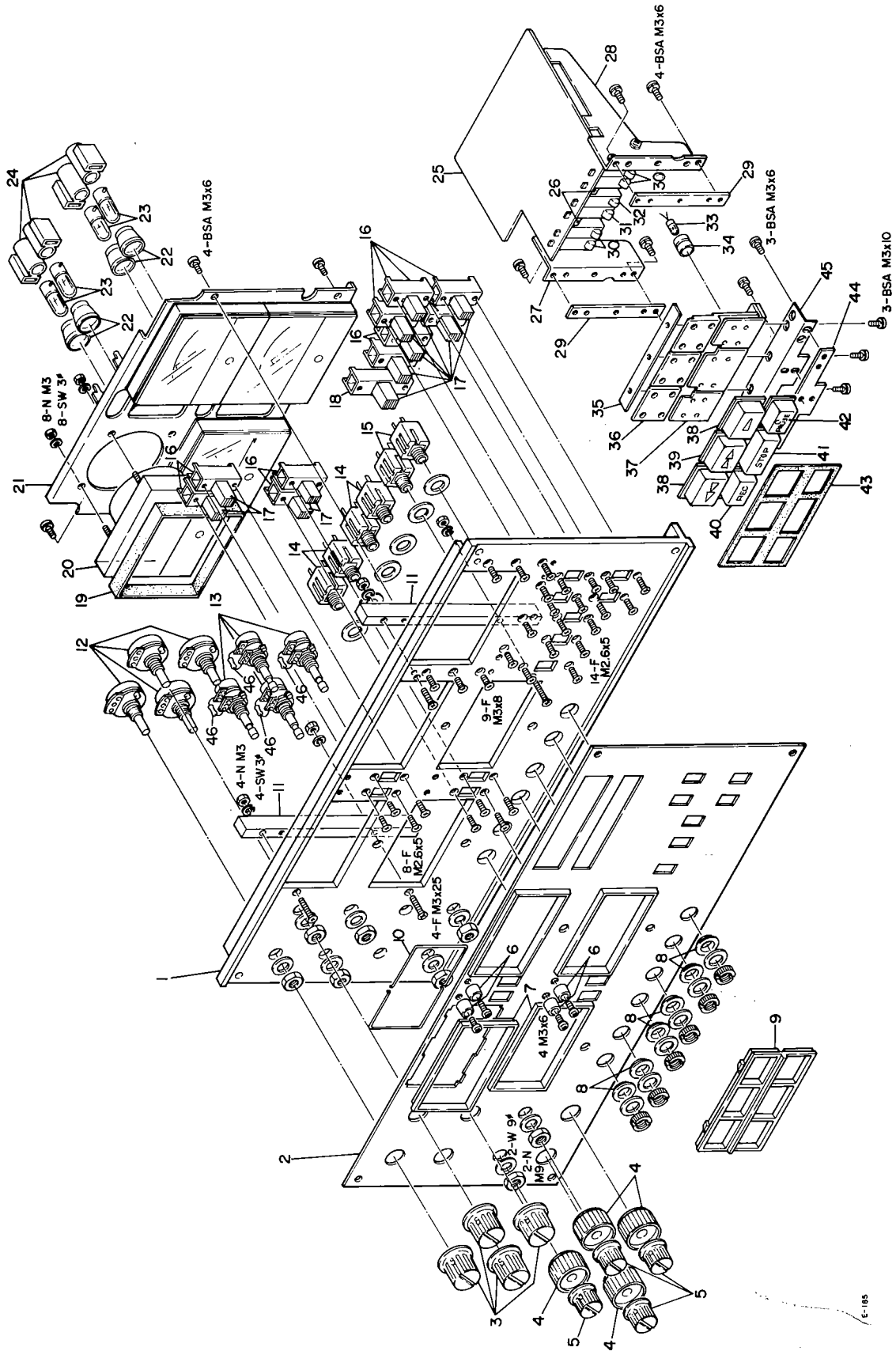

REF. NO.	PARTS NO.	DESCRIPTION	REMARKS
3 - 1	*55520461	Panel, Ampl.	
3 - 2	*55020290	Panel, Ampl.; Trim	
3 - 3	55340910	Knob, A	
3 - 4	55040591	Knob, Lower	
3 - 5	50253750	Knob	
3 - 6	50236430	Escutcheon, Record Lamp	
3 - 7	*50236500	Escutcheon, VU Meter	
3 - 8	*50332650	Washer, Insulating; Jack	
3 - 9	*55320060	Escutcheon, Button	
3 - 10	*50236512	Clamp, Meter Escutcheon	
3 - 11	*50236420	Retainer, VU Meter	
3 - 12	50535240	Var. Res., 100k ohm	
3 - 13	51501170	Var. Res., Outer Shaft 100k ohm/Inner 10k ohm	
3 - 14	*50430240	Jack, Phone; Single	
3 - 15	*50432450	Jack, Phone; 3 Cond.	
3 - 16	50440000	Switch, Slide	
3 - 17	*55340711	Cap, Slide Switch; C	
3 - 18	50444450	Switch, Slide	
3 - 19	*50939110	Band, VU Meter	
3 - 20	50581380	VU Meter	
3 - 21	*55003540	Plate Assy, VU Meter	
3 - 22	*50419070	Sleeve, Record Lamp	
3 - 23	50414580	Lamp, Bayonet Type; Record (8V)	
3 - 24	50415250	Socket, Record Lamp	
3 - 25	*51680653	PC Board Assy, Control Relay	
3 - 26	*50237160	Spacer	
3 - 27	*50237131	Plate, Switch; L	
3 - 28	*50237141	Plate, Switch; R	
3 - 29	*50237121	Plate	
3 - 30	50446580	Switch, Micro; VV-15-3A	
3 - 31	50446560	Switch, Micro; VV-15-1A	
3 - 32	50446570	Switch, Micro; VV-15-2A	
3 - 33	50414630	Lamp, Subminiature; PAUSE	
3 - 34	*50237490	Cushion, Lamp	
3 - 35	*50237291	Plate Nut, Retaining	
3 - 36	*55340430	Hinge, A	
3 - 37	*55340440	Hinge, B	
3 - 38	*55340720	Button, C	
3 - 39	*55340730	Button, D	
3 - 40	*55300731	Button, REC	
3 - 41	*55340740	Button, STOP; B	
3 - 42	*50237262	Button Assy; PAUSE	
3 - 43	*50237300	Rubber Protector, P	
3 - 44	*55505210	Plate Nut, Hinge; S	
3 - 45	*55505200	Bracket, Hinge; S	
3 - 46	*50572060	Carbon Res., 100k ohm 1/4W	

REF. NO.	PARTS NO.	DESCRIPTION	REMARKS
4 - 1	*55505261	Panel, Rear Connection	
4 - 2	*55505221	Chassis, Ampl., Main	
4 - 3	*55505230	Chassis, Ampl., Sub	
4 - 4	*50236480	Hinge	
4 - 5	*55501151	Plat, Fuse Holder	U.S.A., CANADA
4 - 6	*50432950	Socket, AC Power	
4 - 7	*50432700	Socket, 11P	
4 - 8	50434632	Jack, Pin; 2P	
4 - 9	*50452060	Terminal Strip, 1L-2P	
4 - 10	*51680560	PC Board Assy, REC EQ Relay	
4 - 11	*55505281	Angle, PC Board; S	
4 - 12	50490830	PC Board Assy, Bias Oscillator	
4 - 13	*51683440	PC Board Assy, Playback EQ/Mic Ampl.	
4 - 14	*51683450	PC Board Assy, Line Out/Phone Ampl.	
4 - 15	*51683460	PC Board Assy, Record/Meter Ampl.	
4 - 16	*51680541	PC Board Assy, Bias Adjustment; A	
4 - 17	*51680581	PC Board Assy, Bias Adjustment; B	
4 - 18	*50233760	Plate, PC Board	
4 - 19	*50236490	Stand-off, Ampl. Chassis	
4 - 20	*50436530	Connector, 15P (Plug)	GENERAL EXPORT
	*50438300	Connector, 15P (Plug)	U.S.A., CANADA
4 - 21	*50237450	Bracket, Connector	
4 - 22	*50438310	Connector, 15P (Socket)	GENERAL EXPORT
	*50438300	Connector, 15P (Socket)	U.S.A., CANADA
4 - 23	50433010	Dummy Plug	
4 - 24	*50412280	Holder, Fuse; UL	U.S.A., CANADA
4 - 25	50411440	Fuse, 2A	U.S.A., CANADA
4 - 26	*50454071	Post, Grounding	
4 - 27	50411140	Fuse, 2A (100V/117V area)	GENERAL EXPORT
	50411010	Fuse, 1A (220V/240V area)	GENERAL EXPORT
4 - 28	*50435030	Voltage Selector	GENERAL EXPORT
4 - 29	*55501500	Mask, Fuse Holder	GENERAL EXPORT
4 - 30	*50571340	Carbon Res., 150k ohm 1/4W	
4 - 31	*55541630	Sheet, Insulating	Part of 4 - 12
4 - 32	*50424450	Transistor, 2SC1226A (R)	Part of 4 - 12
4 - 33	*55340640	Washer, Insulating	Part of 4 - 12
4 - 34	*55505290	Plate, PC Board; S	

2. PC BOARD SECTION (Diagram)

2-1. EQ/MIC AMPL. PC BOARD

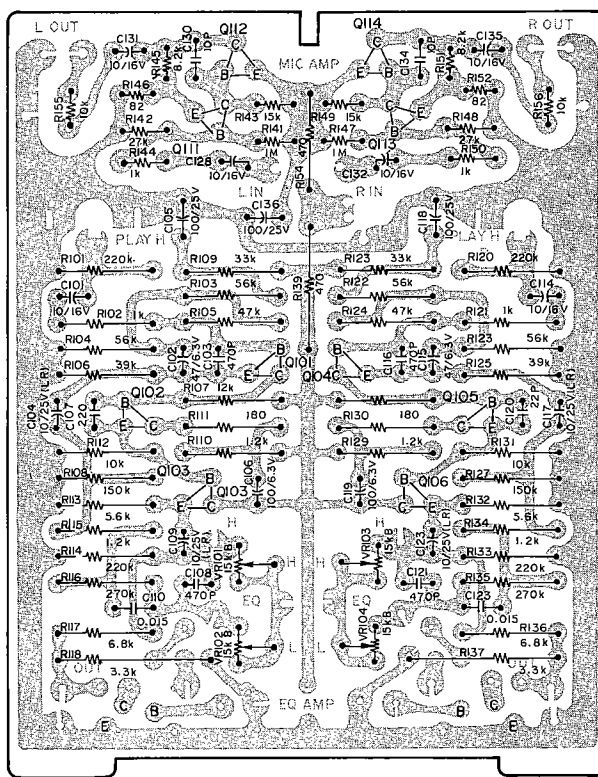

P-234

2-2. LINE/PHONE AMPL. PC BOARD

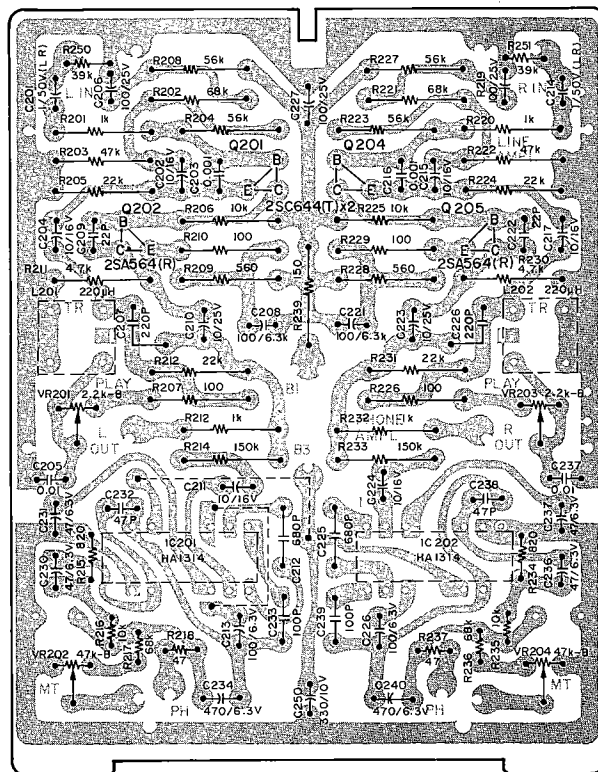

P-235

2-3. RECORD/METER AMPL. PC BOARD

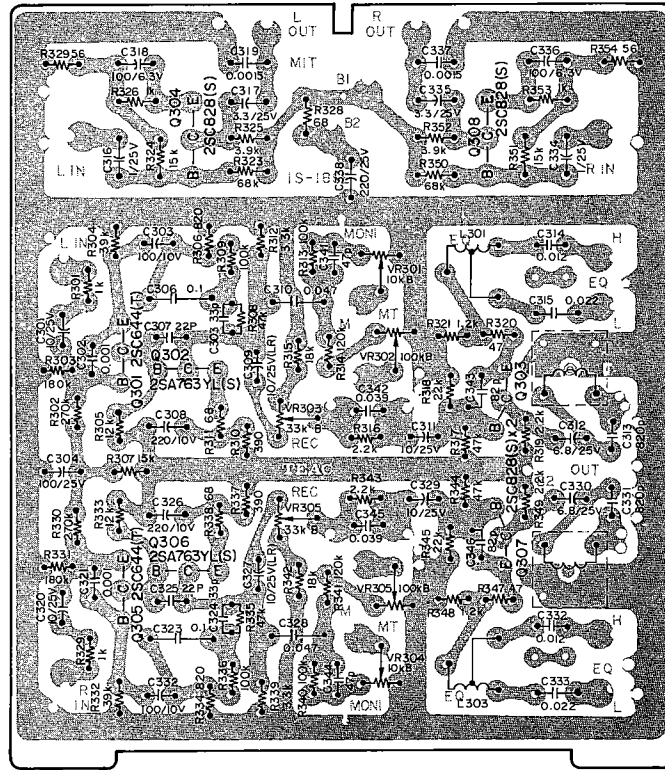

P-236

2-4. SOLENOID CONTROL RELAY

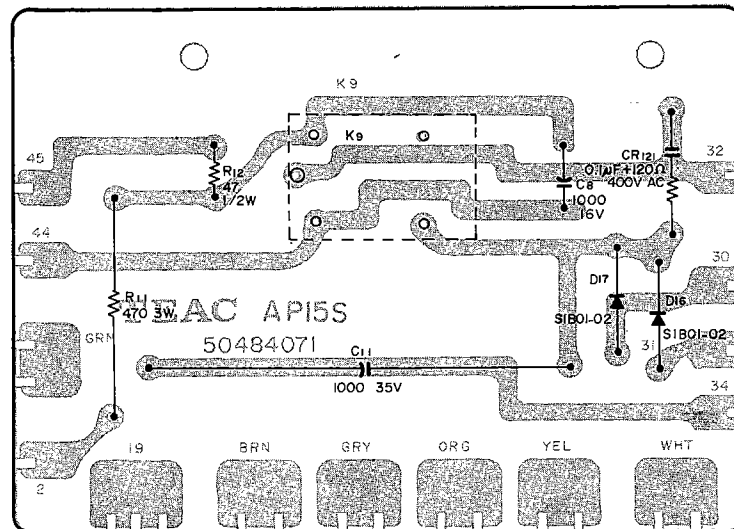

P-162

2-5. CONTROL PC BOARD

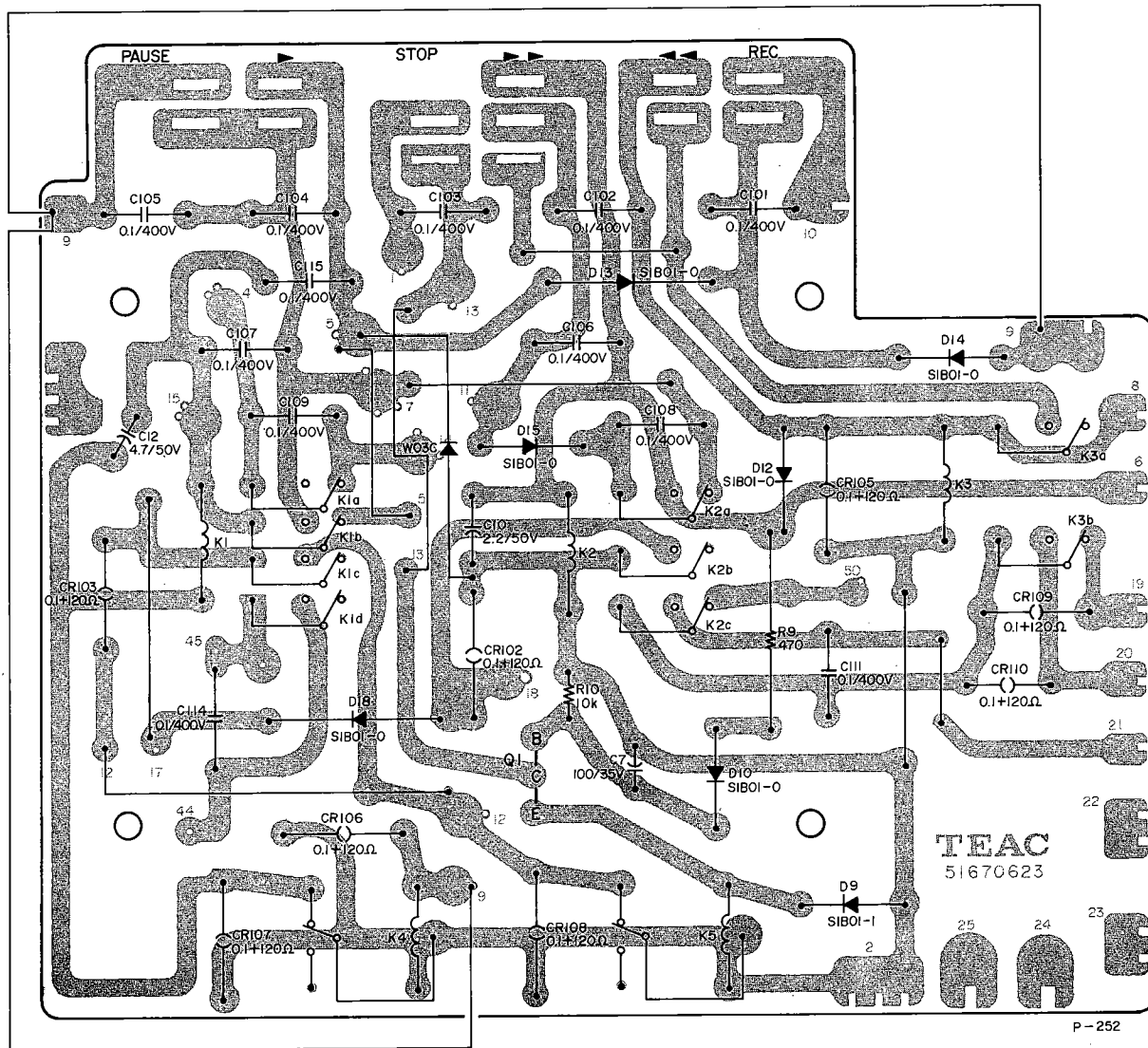

2-6. POWER SUPPLY PC BOARD

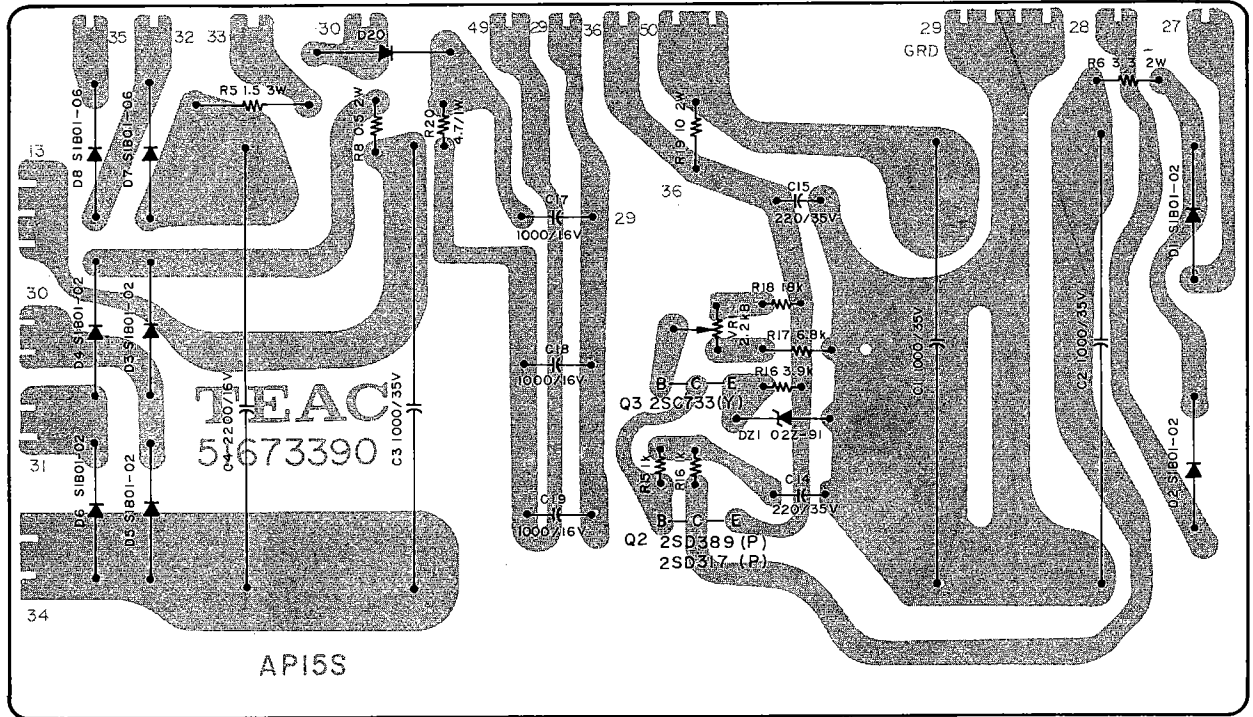

2-7. OSCILLATOR PC BOARD

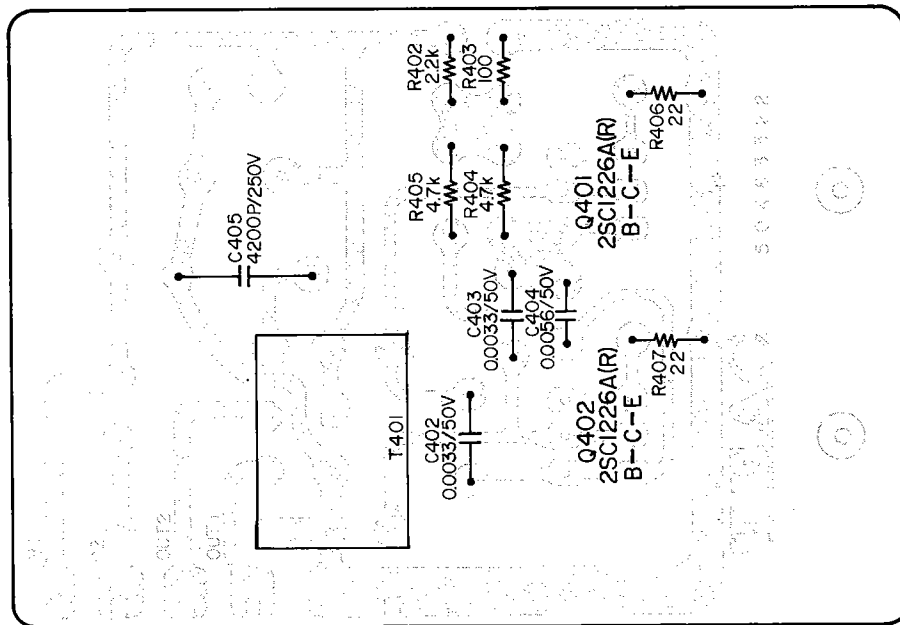

2. PC BOARD SECTION (Parts List)

2-1. EQ/MIC AMPL. PC BOARD

REF. NO.	PARTS NO.	DESCRIPTION
	51683580	PC Board Assy
	51670501	PC Board
TRANSISTORS		
Q101/Q104	50424610	2SC1327 (T) or
	50424710	2SC1345 (E)
Q102/Q105	50424870	2SA721(S)
Q103/Q106	50424600	2SC828 (S) or
	50424860	2SC536 (G)
Q107/Q109	50424600	2SC828 (S) or
	50424860	2SC536 (G)
Q112/Q114	50424640	2SA721(S)

CARBON RESISTORS

All resistors are rated $\pm 5\%$ tolerance and 1/4 watt.

R101/R120	50573380	220k ohm
R102/R121	50572820	1k ohm
R103/R122	50573240	56k ohm
R104/R123	50573240	56k ohm
R105/R124	50573220	47k ohm
R106/R125	50573200	39k ohm
R107/R126	50573080	12k ohm
R108/R127	50572740	470 ohm
R109/R128	50573180	33k ohm
R110/R129	50572840	1.2k ohm
R111/R130	50572640	180 ohm
R112/R131	50573060	10k ohm
R113/R132	50573000	5.6k ohm
R114/R133	50573380	220k ohm
R115/R134	50572840	1.2k ohm
R116/R135	50573400	270k ohm
R117/R136	50573020	6.8k ohm
R118/R137	50572940	3.3k ohm
R139	50572740	470 ohm
R141/R147	50571540	1M ohm
R142/R148	50571160	27k ohm
R143/R149	50571100	15k ohm
R144/R150	50570820	1k ohm
R145/R151	50571040	8.2k ohm
R146/R152	50570560	82 ohm
R154	50572740	470 ohm
R155/R156	50571060	10k ohm

CAPACITORS

C101/C114	51700090	Tant.	10 mfd	16V
C102/C115	50554030	Elec.	47 mfd	6.3V
C103/C116	505457560	Dip. Mica	470 pfd	50V
C104/C117	51700820	Elec.	10 mfd	25V (LR)
C105/C118	50554170	Elec.	100 mfd	25V
C106/C119	50554230	Elec.	100 mfd	6.3V
C107/C120	50543820	Dip. Mica	22 pfd	50V
C108/C121	50547560	Dip. Mica	470 pfd	50V
C109/C122	51700820	Elec.	10 mfd	25V (LR)
C110/C123	50548420	Mylar	0.015 mfd	50V

REF. NO.	PARTS NO.	DESCRIPTION
C 127	50554170	Elec. 100 mfd 25V
C128/C132	50554050	Elec. 10 mfd 16V
C130/C134	50547400	Dip. Mica 10 pfd 50V
C131/C135	50554050	Elec. 10 mfd 16V
C136	50554170	Elec. 100 mfd 25V

VARIABLE RESISTORS

VR101/VR103	50533580	Semi-fixed, 6.8k ohm - B
VR102/VR104	50533540	Semi-fixed, 15k ohm - B

MISCELLANEOUS

J101/J102	50435000	Jack, Pin
-----------	----------	-----------

2-2. LINE/PHONE AMPL. PC BOARD

REF. NO.	PARTS NO.	DESCRIPTION
	51683450	PC Board Assy
	51670511	PC Board
IC's		
IC201/IC202	50427150	HA1314
TRANSISTOR		
Q201/Q204	50423770	2SC644 (T) or
	50424940	2SC900 (E)
Q202/Q205	50424660	2SA564 (R) or
	51450380	2SA750 (E)

CARBON RESISTORS

All resistors are rated $\pm 5\%$ tolerance and 1/4 watt.

R201/R220	50572820	1k ohm
R202/R221	50573260	68k ohm
R203/R222	50573220	47k ohm
R204/R223	50573240	56k ohm
R205/R224	50573140	22k ohm
R206/R225	50573060	10k ohm
R207/R226	50572580	100 ohm
R208/R227	50573240	56k ohm
R209/R228	50572760	560 ohm
R210/R229	50572580	100 ohm
R211/R230	50572980	4.7k ohm
R212/R231	50573140	22k ohm
R213/R232	50572820	1k ohm
R214/R233	50573340	150k ohm
R215/R234	50570800	820 ohm
R216/R235	50571060	10k ohm
R217/R236	50571260	68k ohm
R218/R237	50571220	47 ohm
R239	50572620	150 ohm
R250/R251	50571200	39k ohm

REF. NO.	PARTS NO.	DESCRIPTION
----------	-----------	-------------

CAPACITORS

C201/C214	51700860	Elec.	1 mfd	50V (LR)
C202/C215	50554050	Elec.	10 mfd	16V
C203/C216	50548320	Mylar	0.001 mfd	50V
C204/C217	50554050	Elec.	10 mfd	16V
C205/C218	50548020	Mylar.	0.01 mfd	50V
C206/C219	50554170	Elec.	100 mfd	25V
C207/C220	50547450	Dip. Mica	220 pfd	50V
C208/C221	50554230	Elec.	100 mfd	6.3V
C209/C222	50543820	Dip. Mica	22 pfd	50V
C210/C223	51700820	Elec.	10 mfd	25V (LR)
C211/C224	50554050	Elec.	10 mfd	16V
C212/C225	50547470	Dip. Mica	680 pfd	50V
C213/C226	50554230	Elec.	100 mfd	6.3V
C227	50554170	Elec.	100 mfd	25V
C230/C236	50554030	Elec.	47 mfd	6.3V
C231/C237	50554030	Elec.	47 mfd	6.3V
C232/C238	50547420	Dip. Mica	47 pfd	50V
C233/C239	50547440	Dip. Mica	100 pfd	50V
C234/C240	50554600	Elec.	470 mfd	6.3V
C250	50554920	Elec.	330 mfd	10V

VARIABLE RESISTORS

VR201/VR203	50533640	Semi-fixed, 2.2k ohm - B
VR202/VR204	50533520	Semi-fixed, 47k ohm - B

COILS

L201/L202	50566640	Choke	220 μ H
-----------	----------	-------	-------------

2-3. RECORD/METER AMPL. PC BOARD

REF. NO.	PARTS NO.	DESCRIPTION
----------	-----------	-------------

51683461	PC Board Assy
51670520	PC Board

TRANSISTORS

Q301/Q305	50423770	2SC644 (T) or
	50424940	2SC900 (E)
Q302/Q306	50424870	2SA763 YL (5) or
	51420380	2SA750 (E)
Q303/Q307	50424600	2SC828 (S) or
	50424860	2SC356 (G)
Q304/Q308	50424600	2SC828 (S) or
	50424860	2SC356 (G)

CARBON RESISTORS

All resistors are rated $\pm 5\%$ tolerance and 1/4 watt.

R301/R329	50570820	1k ohm
R302/R330	50571400	270k ohm

REF. NO.	PARTS NO.	DESCRIPTION
----------	-----------	-------------

R303/R331	50571360	180k ohm
R304/R332	50571200	39k ohm
R305/R333	50571080	12k ohm
R306/R334	50570800	820 ohm
R307	50571100	15k ohm
R308/R335	50571220	47k ohm
R309/R336	50571300	100k ohm
R310/R337	50570720	390 ohm
R311/R338	50570540	68 ohm
R312/R339	50570940	3.3k ohm
R313/R340	51571300	100k ohm
R314/R341	50571320	120k ohm
R315/R342	50571120	18k ohm
R316/R343	50570900	2.2k ohm
R317/R344	50571220	47k ohm
R318/R345	50571140	22k ohm
R319/R346	50570900	2.2k ohm
R320/R347	50570500	47 ohm
R321/R348	50570840	1.2k ohm
R323/R350	50571260	68k ohm
R324/R351	50571100	15k ohm
R325/R352	50570960	3.9k ohm
R326/R353	50570820	1k ohm
R327/R354	50570520	56 ohm
R328	50570540	68 ohm

CAPACITORS

C301/C320	50554040	Elec.	10 mfd	25V
C302/C321	50548320	Mylar	0.001 mfd	50V
C303/C322	50554570	Elec.	100 mfd	10V
C304	50554170	Elec.	100 mfd	25V
C305/C323	50543510	Dip. Mica	33 pfd	50V
C306/C324	50548040	Mylar	0.1 mfd	50V
C307/C325	50543820	Dip. Mica	22 pfd	50V
C308/C326	50554910	Elec.	120 mfd	10V
C309/C327	51700820	Elec.	10 mfd	25V (LR)
C310/C328	50548270	Mylar	0.047 mfd	50V
C311/C329	50554040	Elec.	10 mfd	25V
C312/C330	50546622	Dip. Tant.	6.8 mfd	25V
C313/C331	50543340	Polyst.	820 pfd	50V
C314/C332	50548620	Mylar	0.012 mfd	50V
C315/C333	50548290	Mylar	0.022 mfd	50V
C316/C334	50554670	Elec.	1 mfd	25V
C317/C335	50554220	Elec.	3.3 mfd	25V
C318/C336	50554230	Elec.	100 mfd	6.3V
C319/C337	50548120	Mylar	0.0015 mfd	50V
C338	50554180	Elec.	220 mfd	25V
C341/C344	50547420	Dip. Mica	47 pfd	50V
C342/C345	50548630	Mylar	0.039 mfd	50V
C343/C346	50547580	Dip. Mica	82 pfd	50V

COILS

L301/L303	50566370	Record EQ	4.2/2.4 mH
L302/L304	50566300	Trap	3 mH or
	50566590	Trap	3 mH

2-4. SOLENOIDE CONTROL RELAY

REF. NO.	PARTS NO.	DESCRIPTION
	50491592	PC Board Assy U.S.A., CANADA
	50491600	PC Board Assy GENERAL EXPORT
	50484071	PC Board
K9	50611130	Relay LC1-C 12V DC
CR121	50529050	Spark Killer 0.1 mfd + 400WV 120 ohm
R11	50527140	Metal Oxide 470 ohm 3W Film
R12	50526140	Wire Wound 47 ohm 1/2W
C8	50554890	Elec. 1000 mfd 16V
C11	50555100	Elec. 1000 mfd 35V
D16, D17	50422560	Diode SIB01-02

2-5. CONTROL PC BOARD

REF. NO.	PARTS NO.	DESCRIPTION
	51680653	PC Board Assy
	51670623	PC Board
TRANSISTOR		
Q1	50424620	2SD235 (Y)
DIODES		
D9~D15	50422560	SIB01-02
D25	51430890	W03C
RELAYS		
K1	50610690	4PDT DC24V
K2	50611120	3PDT DC24V
K3	50611140	2PDT DC24V
K4	50611200	SPDT DC24V
K5	50611170	SPDT DC24V
RESISTORS		
R9	50574740	Carbon 470 ohm 1/2W
R10	50575060	Carbon 10k ohm 1/2W
CAPACITORS		
C7	50554630	Elec. 100 mfd 35V
C10	50554980	Elec. 2.2 mfd 50V
C12	50554080	Elec. 4.7 mfd 50V
C101~C109	50549920	Metalized 0.1 mfd 400V AC Mylar
C111	50549920	Metalized 0.1 mfd 400V AC Mylar
C114, C115	50549920	Metalized 0.1 mfd 400V AC Mylar
CR102, CR103	50529050	Spark Killer 0.1 mfd + 120 ohm 400V
CR105~CR110	50529050	Spark Killer 0.1 mfd + 120 ohm 400V

2-6. POWER SUPPLY PC BOARD

REF. NO.	PARTS NO.	DESCRIPTION
	51683390	PC Board Assy
	51673390	PC Board
TRANSISTORS		
Q2	50424620	2SD235 (Y)
Q3	50424820	2SC733 (GR)
DIODES		
DZ1	50425140	Zener, WZ061 or
	50422580	Zener, 02Z 6.2A
D1~D6	50422560	SIB01-02
D7, D8	50422570	SIB01-06
RESISTORS		
R5	51807140	Wire Wound 1.5 ohm 3W
R6	50525400	Wire Wound 3.3 ohm 2W
R8	50526150	Wire Wound 0.5 ohm 2W
R14, R15	50570820	Carbon 1k ohm 1/4W
R16	50570960	Carbon 3.9k ohm 1/4W
R17	50571020	Carbon 6.8k ohm 1/4W
R18	50571120	Carbon 18k ohm 1/4W
R19	50528010	Wire Wound 10 ohm 3W
R20	50526170	Wire Wound 4.7 ohm 2W
CAPACITORS		
C1, C3	50555110	Elec. 1000 mfd 35V
C2	50555700	Elec. 1000 mfd 50V
C4	50555660	Elec. 2200 mfd 16V
C14, C15	50554380	Elec. 220 mfd 35V
C17~C19	50554890	Elec. 1000 mfd 16V
VARIABLE RESISTORS		
VR1	50533640	Semi-fixed, 2.2k ohm - B

2-7. OSCILLATOR PC BOARD

REF. NO.	PARTS NO.	DESCRIPTION
	50490830	PC Board Assy
	50483322	PC Board
Q401, Q402	50424450	Transistor, 2SC1226A (R)
T401	50563231	Oscillator Unit
R402	50514920	Carbon 2.2k ohm 1/2W
R403	50515210	Carbon 100 ohm 1/4W
R404, R405	50516440	Carbon 4.7k ohm 1/2W
R406, R407	50516130	Carbon 22 ohm 1/2W
C402, C403	50548810	Mylar 0.0033 mfd 50V 5%
C404	50548920	Mylar 0.0056 mfd 50V 5%
C405	50544040	Mica 4200 pfd 250V 5%
	55541630	Spacer, Insulator
	55340640	Washer, Insulator

2-8,9. BIAS PC BOARD-A,B

REF. NO.		PARTS NO.	DESCRIPTION	
FRONT	REAR	51680541	PC Board Assy, A	for FRONT channels
		51680581	PC Board Assy, B	for REAR channels
VC501/VC503	VC601/VC603	51670541	PC Board, A	for FRONT channels
		51670581	PC Board, B	for REAR channels
VC502/VC504	VC602/VC604	50547070	Trimmer Capacitor	80 pfd Max.
L501/L502	L601/L602	50547070	Trimmer Capacitor	80 pfd Max.
D501	D601	50566620	Coil, Dummy Load	3 mH
R501	R601	50422560	Diode	SIB01-02
K501	K601	50510080	Carbon	82 ohm 1/2W
K502/K503	K602/K603	50610690	Relay	4T 24V DC
C501	C601	50611260	Relay	2T 24V DC
C502/C503	C602/C603	50554220	Elec.	3.3 mfd 25V
		50549920	Mylar	0.1 mfd 400V

3. INCLUDED ACCESSORIES

REF. NO.	PARTS NO.	DESCRIPTION	REMARKS
	*51280010	Cords, Input-output Connection, 2 used	
	*50478250	Cord, AC Power	U.S.A., CANADA
	*50470772	Cord, AC Power or (51280260)	GENERAL EXPORT
	**RE-702	Empty Reel, 7 inch Small Hub	
	*57100300	Cleaning Stick (TZ-275)	
	*50291350	Silicone Cloth	
	*50291860	Oil and Applicator	
	*50276971	Rubber Feet (For Horizontal Use)	
	*50629620	Splicing Tape	
	*50411440	Fuse, 2A-250V UL	U.S.A., CANADA
	*50411140	Fuse, 1A (220V/240V area)	GENERAL EXPORT
	*50411010	Fuse, 2A (100V/117V area)	GENERAL EXPORT
	*51014070	A-2340SX Owner's Manual	U.S.A., CANADA
	51014080	A-2340SX Owner's Manual	GENERAL EXPORT
	51013371	Information Supplement (Open Reel)	

NOTE: **The Empty Reel is available as an Optional Accessory and thus is not assigned a special TEAC Parts number. Please order this by the MODEL CODE NUMBER (RE-702). This number is included on the package.

ASSEMBLING HARDWARE CODING LIST

All screws conform to ISO standards, and have crossrecessed heads, unless otherwise noted. ISO screws have the head inscribed with a point as in the figure to the right.

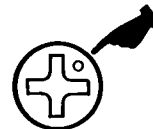

FOR EXAMPLE:

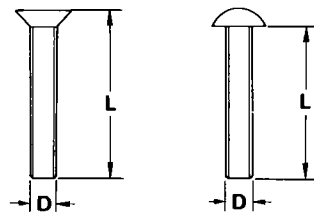
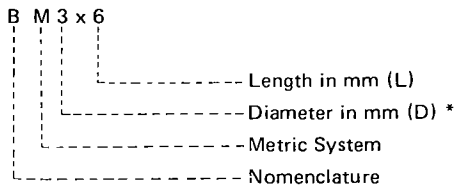

* Inner dia. for washers and nuts

	Code	Name	Type		Code	Name	Type
MACHINE SCREW	R	Round Head Screw		TAPPING SCREW	BTA	Binding Head Tapping Screw(A Type)	
	P	Pan Head Screw			BTB	Binding Head Tapping Screw(B Type)	
	T	Stove Head Screw (Truss)			RTA	Round Head Tapping Screw(A Type)	
	B	Binding Head Screw			RTB	Round Head Tapping Screw(B Type)	
	F	Flat Countersunk Head Screw		SETSCREW	SF	Hex Socket Setscrew(Flat Point)	
	O	Oval Countersunk Head Screw			SC	Hex Socket Setscrew(Cup Point)	
WOOD SCREW	RW	Round Head Wood Screw			SS	Slotted Socket Setscrew(Flat Point)	
	FW	Flat Countersunk Wood Screw		WASHER	E	E-Ring (Retaining Washer)	
	OW	Oval Countersunk Wood Screw			W	Flat Washer (Plain)	
SEMS SCREW	BSA	Binding Head SEMS Screw(A Type)			SW	Lock Washer (Spring)	
	BSB	Binding Head SEMS Screw(B Type)			LWI	Lock Washer (Internal Teeth)	
	BSF	Binding Head SEMS Screw(F Type)			LWE	Lock Washer (External Teeth)	
	PSA	Pan Head SEMS Screw(A Type)			TW	Trim Washer (Countersunk)	
	PSB	Pan Head SEMS Screw(B Type)		NUT	N	Hex Nut	

A-2340SX

4-Channel Stereo Tape Deck

TEAC

TEAC CORPORATION

3-7-3, NAKA-CHO, MUSASHINO, TOKYO PHONE: (0422) 53-1111

TEAC CORPORATION OF AMERICA

7733 TELEGRAPH ROAD, MONTEBELLO, CALIFORNIA 90640 PHONE: (213) 726-0303

TEAC HONGKONG LIMITED

FLAT 78, PORTLAND HOUSE, 7TH FLOOR, BLOCK C, No. 41-D, MA TAU WEI ROAD,
KOWLOON, HONGKONG PHONE: 3-659071-4

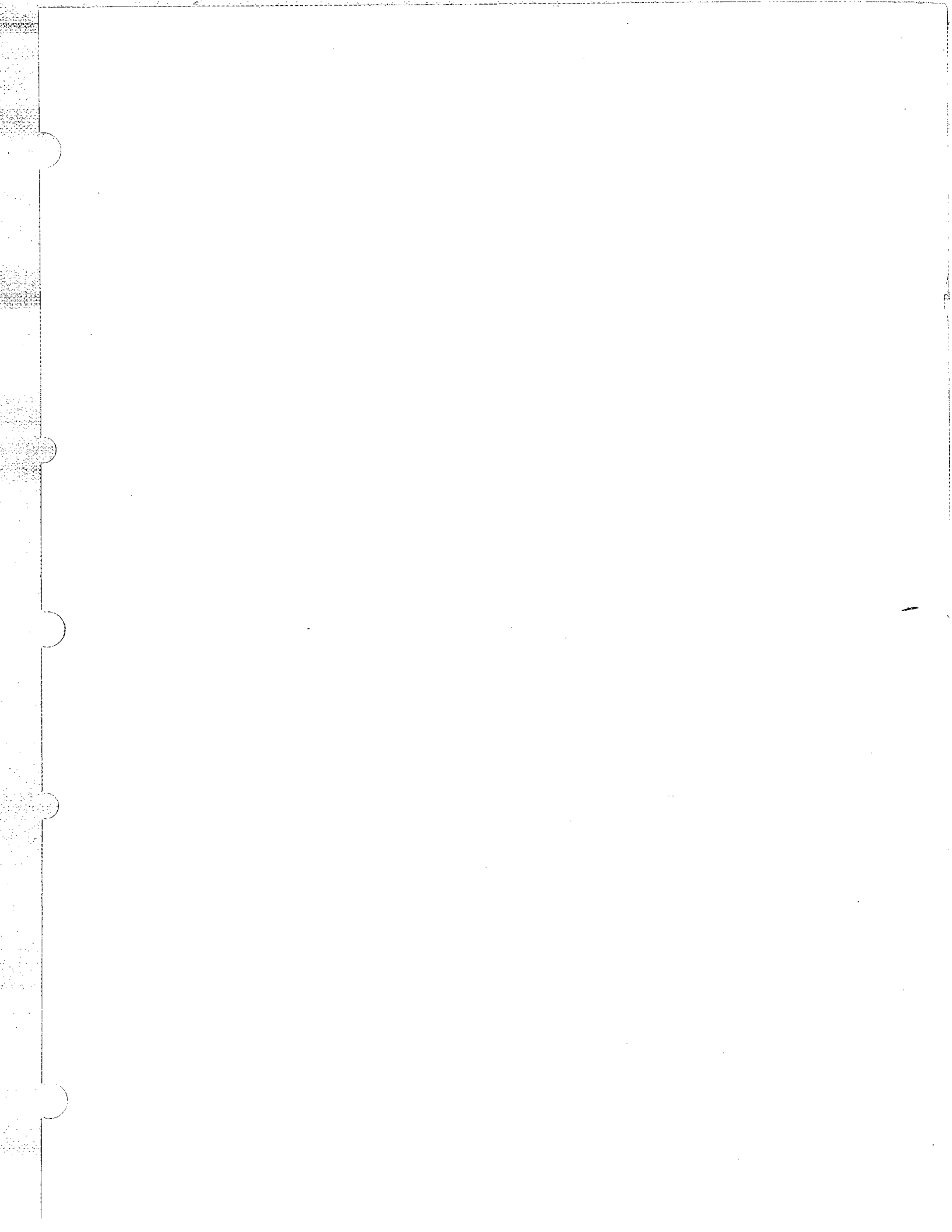

A-2340SX

4-Channel Stereo Tape Deck

TEAC®

TEAC CORPORATION

3-7-3, NAKA-CHO, MUSASHINO, TOKYO PHONE: (0422) 53-1111

TEAC CORPORATION OF AMERICA

7733 TELEGRAPH ROAD, MONTEBELLO, CALIFORNIA 90640 PHONE: (213) 726-0303

TEAC HONGKONG LIMITED

FLAT 78, PORTLAND HOUSE, 7TH FLOOR, BLOCK C, No. 41-D, MA TAU WEI ROAD,
KOWLOON, HONGKONG PHONE: 3-659071-4