

TC-399

US Model
Canadian Model
UK Model
AEP Model

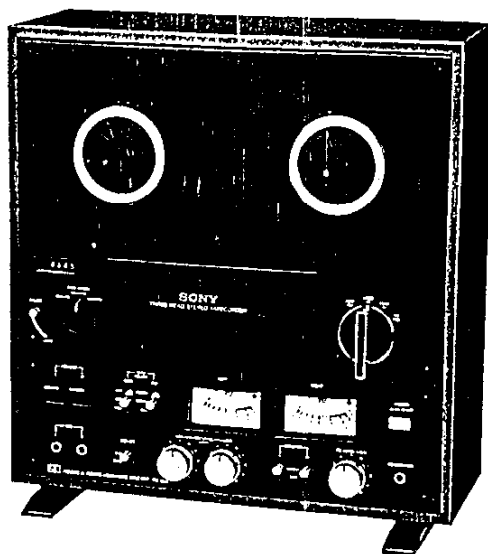

THE QUALITY OF
THIS MANUAL IS
THE BEST THAT
IS AVAILABLE

STEREO TAPE DECK

SPECIFICATIONS

Power Requirements:	120V ac, 60 Hz (US, Canadian model) 110V, 120V, 220V, 240V, 50/60 Hz (UK, AEP model)	Track:	4-track 2-channel stereo
Power Consumption:	25W (US, Canadian model) 35W (AEP, UK model)	Tape Speed:	19 cm/s (7 1/2 ips), 9.5 cm/s (3 3/4 ips) 4.8 cm/s (1 7/8 ips)
Dimensions:	415 (w) x 435 (h) x 190 (d) mm 16 3/8 (w) x 17 1/4 (h) x 7 1/2 (d) inches including projecting parts and controls	Recording Time:	With 550 m tape, 18 cm reel Stereo recording: 90 min. at 19 cm/s Mono recording: 360 min. at 9.5 cm/s
Weight:	Approx. 12.6 kg (27 lb 13 oz) (US, Canadian model) Approx. 12.9 kg (28 lb 7 oz) (UK, AEP model)	Fast Winding Time:	Approx. 120 sec. with 370 m tape
		Reel:	18 cm or smaller
		Heads:	1 record head, 1 playback head, 1 erase head
		Record Bias Frequency:	160 kHz
		Equalization:	NAB standard (US, Canadian model) JIS standard 19 cm/s 3,180µS + 50µS 9.5 cm/s 3,180µS + 90µS (UK, AEP model)
		S/N Ratio:	With Sony Ferri-Chrome Tape 61 dB at peak level (NAB) 58 dB (DIN, 1975 rev.): (UK, AEP model)

FOR SERVICE MANUALS

CONTACT:

MAURITRON TECHNICAL SERVICES

www.mauritron.co.uk

TEL: 01844 351694

FAX: 01844 352554

— Continued on page 2 —

SONY

SERVICE MANUAL

Total Harmonic Distortion: 0.8%

Frequency Response: With Sony Ferri-Chrome tape or SLH tape
 30–25,000 Hz \pm 3 dB at 19 cm/s
 30–18,000 Hz \pm 3 dB at 9.5 cm/s
 With regular tape
 30–18,000 Hz \pm 3 dB at 19 cm/s
 30–15,000 Hz \pm 3 dB at 9.5 cm/s

Wow and Flutter: 0.06% at 19 cm/s (NAB)
 \pm 0.09% at 19 cm/s (DIN): (UK, AEP model)
 0.09% at 9.5 cm/s (NAB)
 \pm 0.12% at 9.5 cm/s (DIN): (UK, AEP model)

Inputs: MIC (two phono jacks)
 sensitivity 0.25 mV (-70 dB)
 for low impedance microphone
 LINE IN (two phono jacks)
 sensitivity 77.5 mV (-20 dB)
 input impedance 100 k Ω
 REC/PB (DIN connector): (UK, AEP model)
 input impedance less than 10 k Ω

Outputs: LINE OUT (two phono jacks)
 output level 0.435V (-5 dB) at load impedance of 100 k Ω , with PB LEVEL controls set to center-detent position;
 0.775V (0 dB) with the PB LEVEL controls set to "10"
 suitable load impedance more than 10 k Ω
 HEADPHONES (binaural jack)
 output level 38.8 mV (-26 dB) at load impedance 8 Ω with PB LEVEL controls set to center-detent position
 REC/PB (DIN connector): (UK, AEP model)
 output impedance less than 10 k Ω

0 dB = 0.775 V

MODEL IDENTIFICATION
 (Specification Label)

(US model)

SONY.			
TAPECORDER TC-399			
AC	120 V	60 Hz	25 W
NO. <input style="width: 100%;" type="text"/>			
MADE IN JAPAN			

(Canadian model)

SONY.			
TAPECORDER TC-399			
AC	120V	60Hz	25 W
NO. <input style="width: 100%;" type="text"/>			
MADE IN JAPAN			

(AEP, UK model)

SONY.			
TAPECORDER TC-399			
110,120,220,240V	~	50/60Hz	35 W
NO. <input style="width: 100%;" type="text"/>			
MADE IN JAPAN			

FOR SERVICE MANUALS
 CONTACT:
MAURITRON TECHNICAL SERVICES
 www.mauritron.co.uk
 TEL: 01844 - 351694
 FAX: 01844 - 352554

POWER FREQUENCY ADAPTATION

The motor pulley and tapping of the motor capacitor terminals must be changed, if the line frequency differs from what the recorder is set for.

1. To change connection of the motor capacitor terminals

The motor capacitor is located at the upper side of the drive mechanism. Change the connection of the motor capacitor terminals by soldering as illustrated.

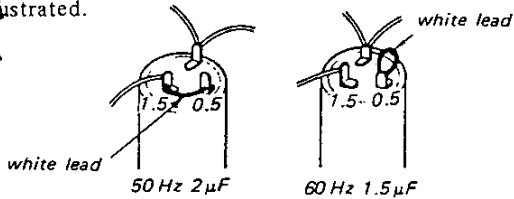

2. To change motor pulley

Remove the panel as described in DISASSEMBLY on page 5.

1. Remove the pause stroke adjusting plate by loosening the screw **A**. Withdraw the pause pull rod.
2. Remove a rubber belt from the motor pulley and idler wheel.
3. Remove the motor pulley by loosening two screws **B** and **C** which hold the motor pulley.
4. Use the supplied motor pulley with the same mark and tighten the screws.

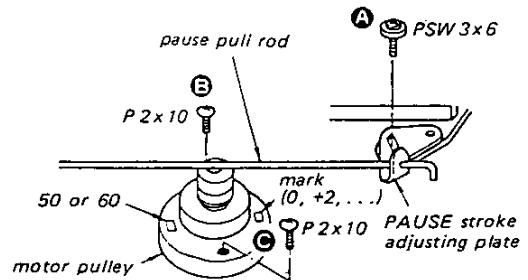

Motor Pulley Part No.			
for 50 Hz		for 60 Hz	
Mark on Motor Pulley	Part No.	Mark on Motor Pulley	Part No.
+2	3-518-067-61	+2	3-518-068-61
+1	3-518-067-51	+1	3-518-068-51
+0.5	3-518-067-41	+0.5	3-518-068-41
0	3-518-067-01	0	3-518-068-01
-0.5	3-518-067-11	-0.5	3-518-068-11
-1	3-518-067-21	-1	3-518-068-21
-2	3-518-067-31	-2	3-518-068-31

SECTION 1
OUTLINE

FOR SERVICE MANUALS
CONTACT:
MAURITRON TECHNICAL SERVICES

www.mauritron.co.uk
TEL: 01844 - 351694
FAX: 01844 - 352554

1-1. BLOCK DIAGRAM

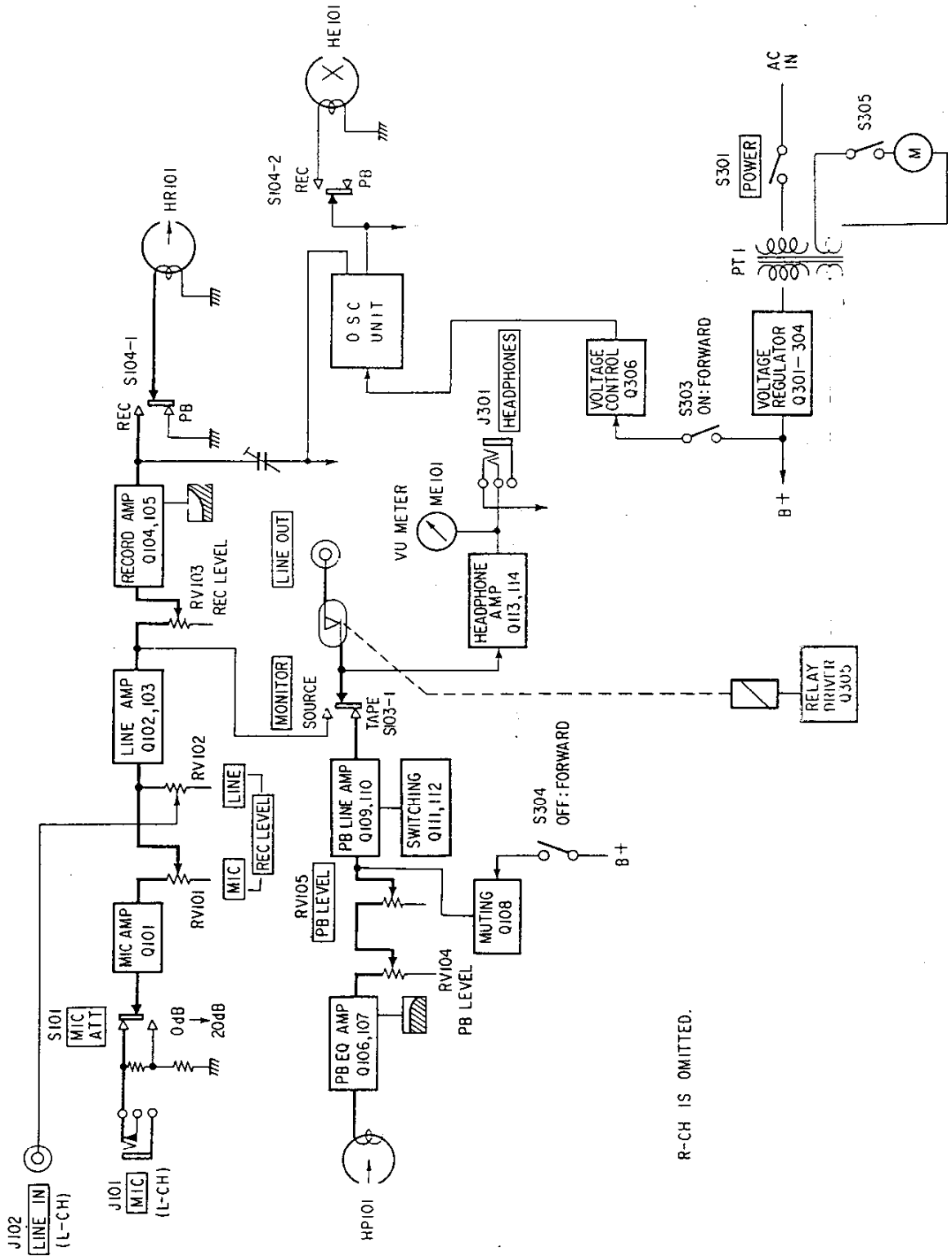

R-CH IS OMITTED.

SECTION 2
DISASSEMBLY

Note: Follow the disassembly procedure in the numerical order given.

PANEL ASSEMBLY AND MAIN CHASSIS REMOVAL

- ① to ⑩ : Panel Assembly Removal
- ⑪ to ⑮ : Main Chassis Removal

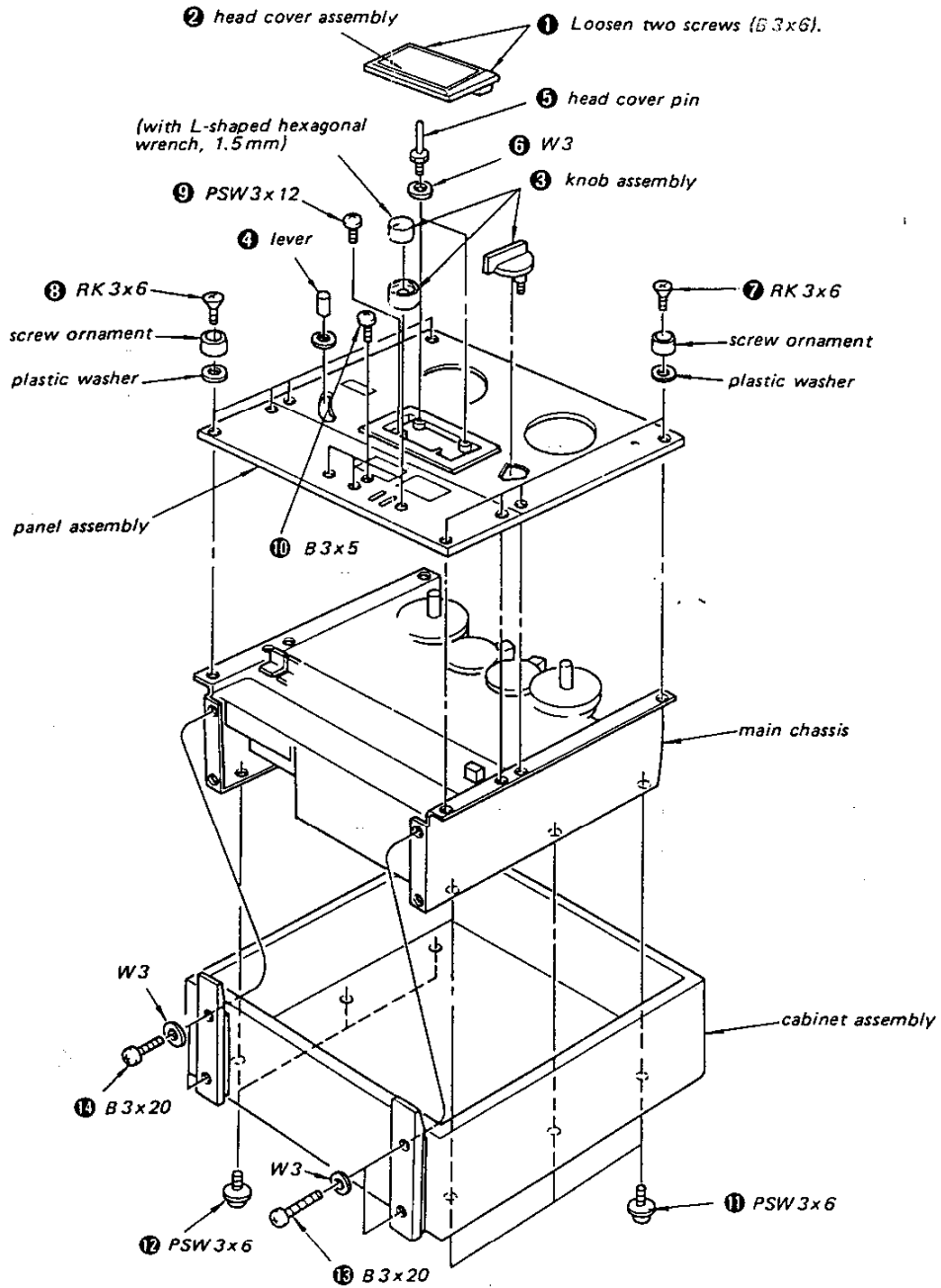

HEAD DECK ASSEMBLY REMOVAL

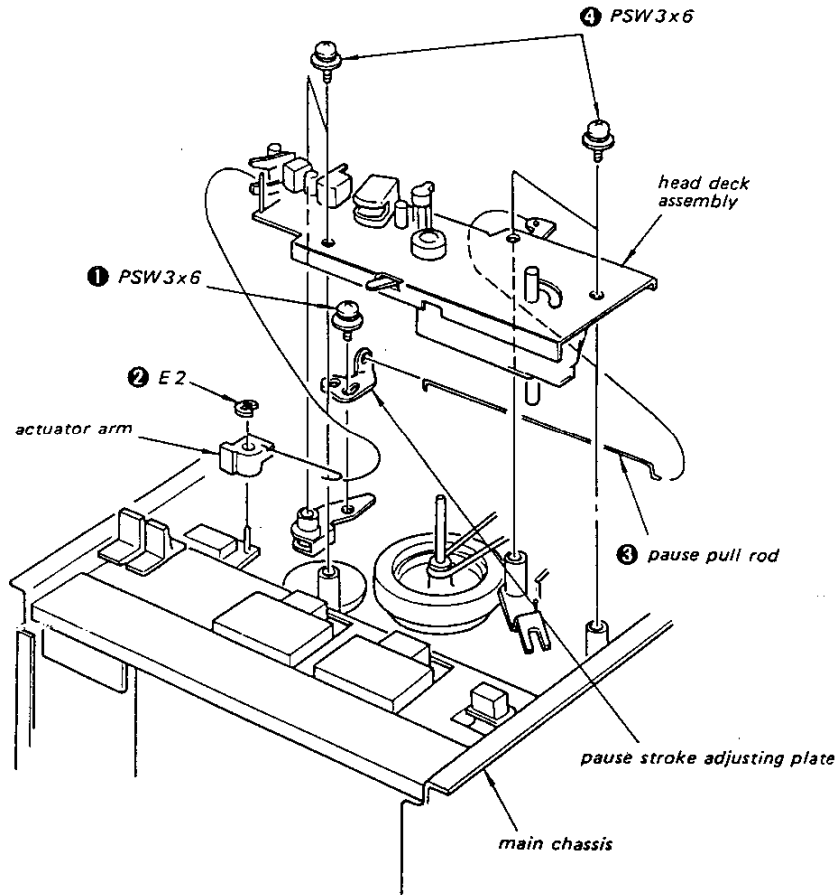

Note: After installing the head deck assembly, perform the Pause Stroke Adjustment.

FOR SERVICE MANUALS
CONTACT:
MAURITRON TECHNICAL SERVICES

www.mauritron.co.uk

TEL: 01844 - 351694

FAX: 01844 - 352554

SECTION 3 ADJUSTMENTS

3-1. MECHANICAL ADJUSTMENT

PRECAUTION

1. Clean the following parts with a denatured-alcohol-moistened swab:

record head	pinch roller
playback head	rubber belts
erase head	idlers
capstan	tape guides
2. Demagnetize the record head and the playback head with a head demagnetizer.
3. Do not use a magnetized screwdriver for the adjustments.
4. After the adjustments, apply a suitable locking compound to the parts adjusted.
5. Adjustments should be performed in the order given in this service manual.
6. The adjustments and measurements should be performed with the rated power supply voltage unless otherwise noted.

Tension Regulator Back-tension Adjustment:

— forward and fast forward modes —

Note: This adjustment should be performed after the Tension Regulator Adjustment shown at the left.

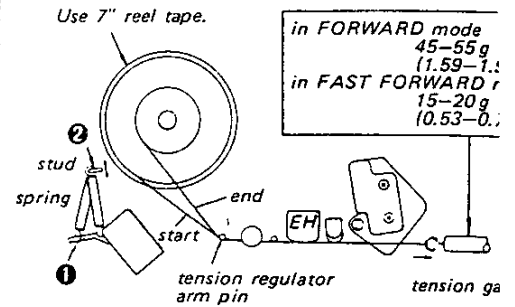

- ① Adjust by changing the spring hook position.
- ② If necessary, bend the stud or perform the tension regulator adjustment again.

Tension Regulator Adjustment

— stop mode —

1. Loosen the adjustment screw and adjust the tension regulator arm for the clearance after turning the supply reel table counterclockwise by hand.

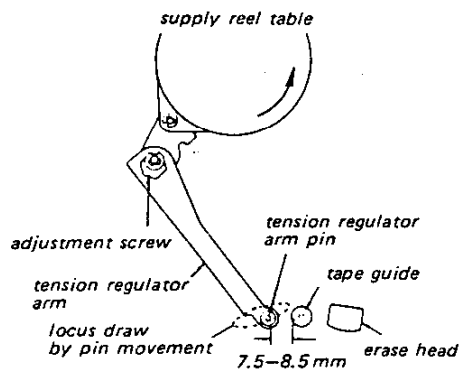

2. Tape should be in contact with the tension regulator arm pin uniformly at both the beginning and end portions of it. If necessary, bend the portion A.

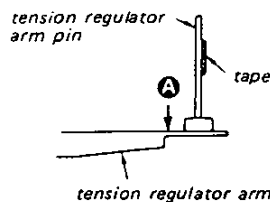

FOR SERVICE MANUALS
CONTACT:

MAURITRON TECHNICAL SERVICES

www.mauritron.co.uk

TEL: 01844 - 351694

FAX: 01844 - 352554

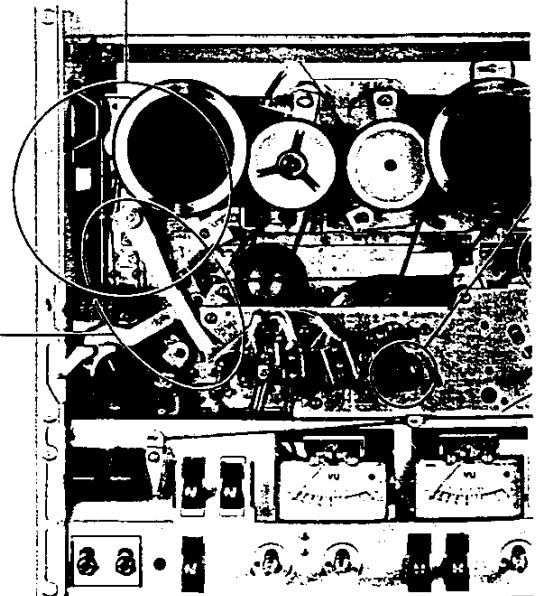

SECTION 3
ADJUSTMENTS

Tension Regulator Back-tension Adjustment

— forward and fast forward modes —

Note: This adjustment should be performed after the Tension Regulator Adjustment shown at the left.

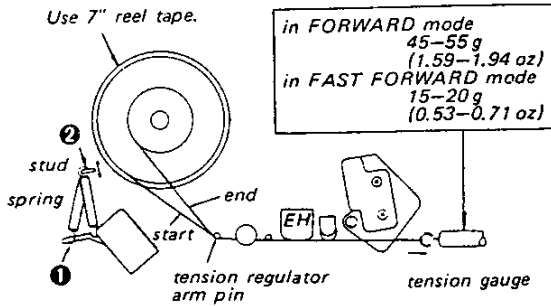

- 1 Adjust by changing the spring hook position.
- 2 If necessary, bend the stud or perform the tension regulator adjustment again.

Pinch Roller Pressure Check

— stop mode —

1. Remove the head deck assembly
2. Put a dummy capstan into the c and be sure that the clearance between levers (A) and (B) is 0.2-1 mm.

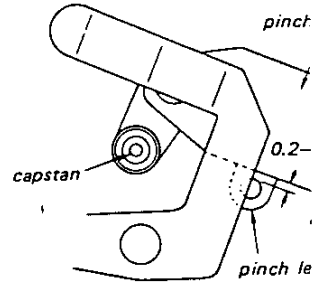

head deck — back view

3. Be sure that the tension gauge 1,000 g (1 lb 12 oz-2 lb 3 oz) w roller is detached from the cap: mode.

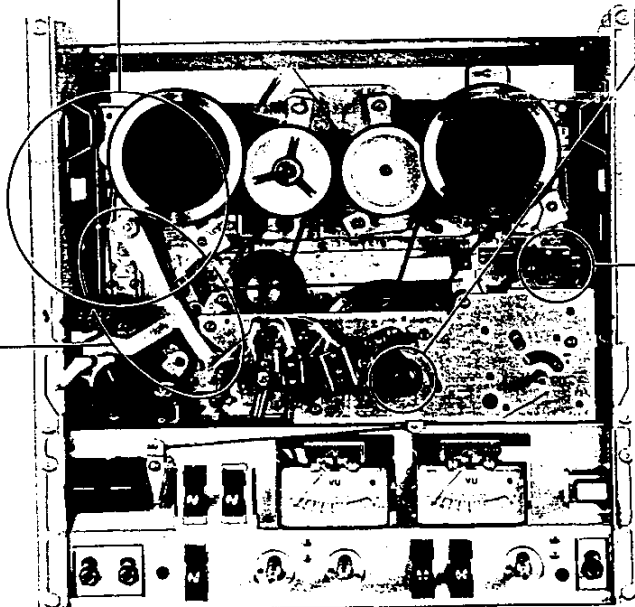
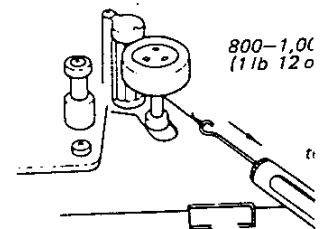

Bias Osc Switch (S303) Position Ad.

Loosen the two screws and ad position for the specified clearance should be turned on in forward m when the mode is changed slowly f: stop, the record levers release after turned off.

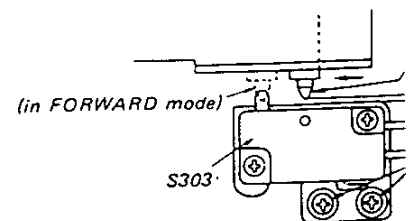

h a denatured-

ller
velts

nd the playback

wdriver for the.

suitable locking

ed in the order

ents should be
r supply voltage

and adjust the
e clearance after
counterclockwise

regulator

tape guide

erase head

with the tension
y at both the
it. If necessary,

tape

arm

Pinch Roller Pressure Check

— stop mode —

1. Remove the head deck assembly.
2. Put a dummy capstan into the capstan bearing and be sure that the clearance between pinch levers (A) and (B) is 0.2–1 mm.

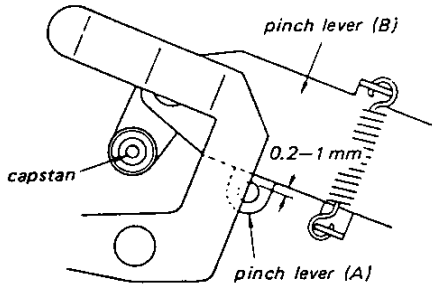

head deck — back view —

3. Be sure that the tension gauge indicates 800–1,000 g (1 lb 12 oz–2 lb 3 oz) when the pinch roller is detached from the capstan in forward mode.

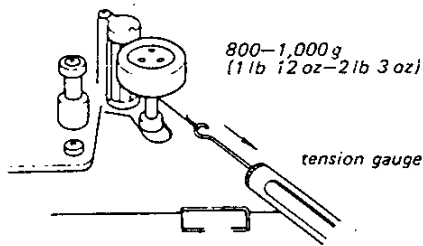

Bias Osc Switch (S303) Position Adjustment

Loosen the two screws and adjust the switch position for the specified clearance. The switch should be turned on in forward mode. Confirm, when the mode is changed slowly from forward to stop, the record levers release after the switch is turned off.

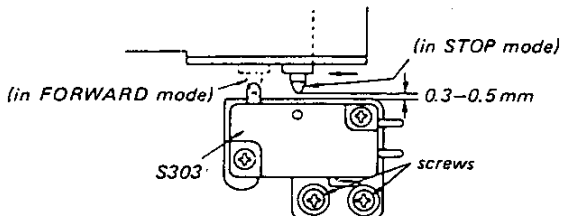

Pinch Roller Stroke Adjustment

1. Remove the head deck assembly.
2. Loosen the adjustment screw and adjust the position of the joint lever so that the pinch roller shaft comes in contact with the retractive lever at position **A** in stop mode.
3. Fix the adjustment screw while pushing the joint lever in the direction shown by the arrow.
4. Put the dummy capstan into the capstan bearing and be sure that the pinch roller shaft moves on surface **B** of the retractive lever when the mode is changed from stop to forward.
5. Be sure that the washer on the pinch roller shaft does not come in contact with position **C** when the mode is slowly changed from forward to fast forward.

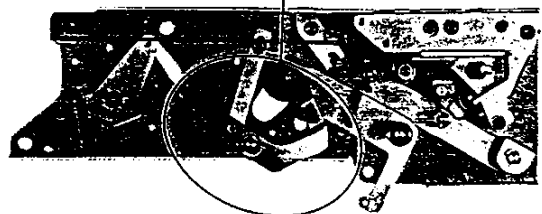
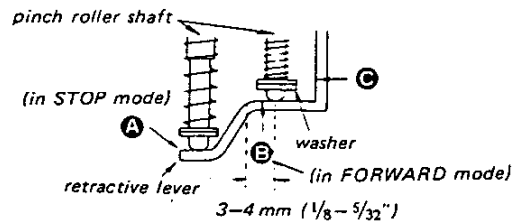
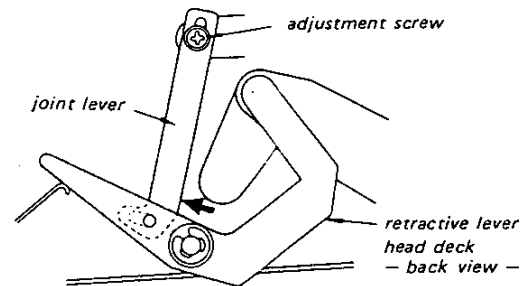

Head deck — bottom view —

Pause Stroke Adjustment

— stop mode —

Note: This adjustment should be performed after the Tension Regulator Adjustment shown on page 7.

1. Adjust screw **A** so that the distance between the end of the pause pull rod and the pause stroke adjustment plate is 4–5 mm in stop mode.
2. Be sure that the clearance between the pinch roller and the capstan is 0.5–1 mm when pulling the pause lever in forward mode, and the PAUSE lever (controlled by user) is not locked when pulling the pause lever in stop mode.
3. Adjust screw **B** so that the clearance between the tension regulator arm and the pause leaf spring is 2–3 mm in stop mode. The brake should work, when pulling the pause lever in forward mode.

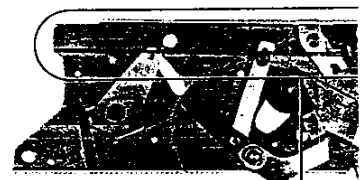
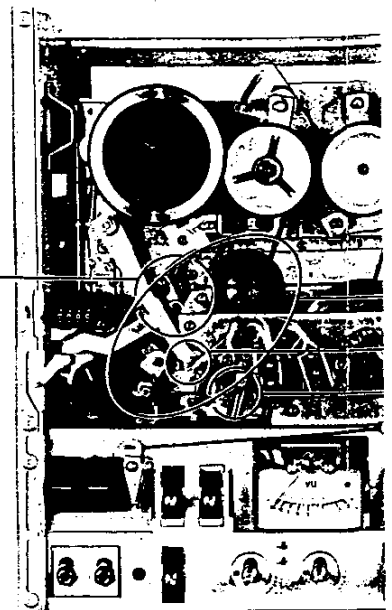
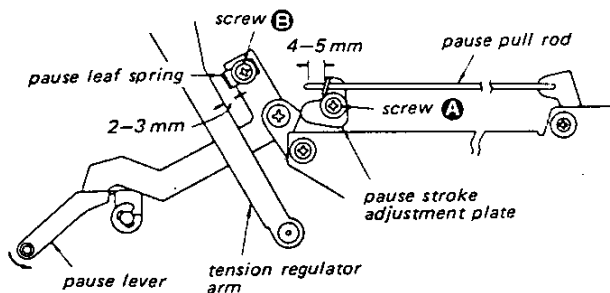

Speed Selector Cam Position Adjustment

— forward mode —

Turn the adjustment screw and locate the idler arm pin in the slot at 19 cm/s tape speed.

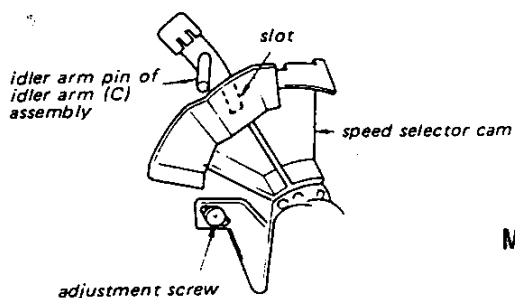

Shut-off Mechanism Adjustment

— stop mode —

1. Remove the head deck assembly.
2. Loosen two screws **A** and adjust the position of the shut-off lever holding plate assembly so that the shut-off mechanism is locked when the clearance between the shut-off arm end and head deck is 7 mm, and the shut-off mechanism is released completely when it is 3–5 mm.

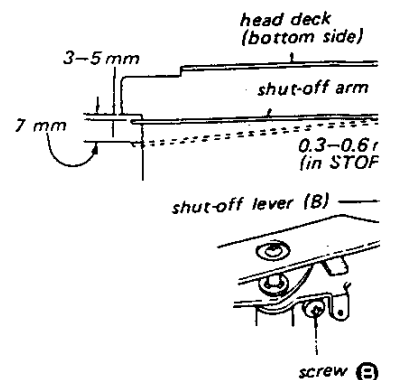

FOR SERVICE MANUALS
CONTACT:
MAURITRON TECHNICAL SERVICES
www.mauritron.co.uk
TEL: 01844 - 351694
FAX: 01844 - 352554

tween
pause
stop

pinch
when
, and
s not
stop

ween
leaf
brake
er in

ll rod

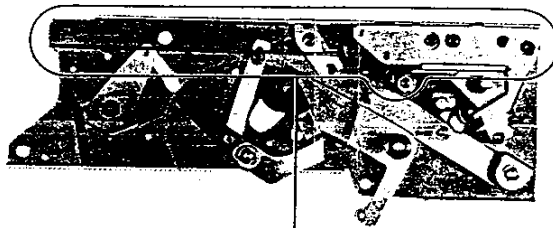
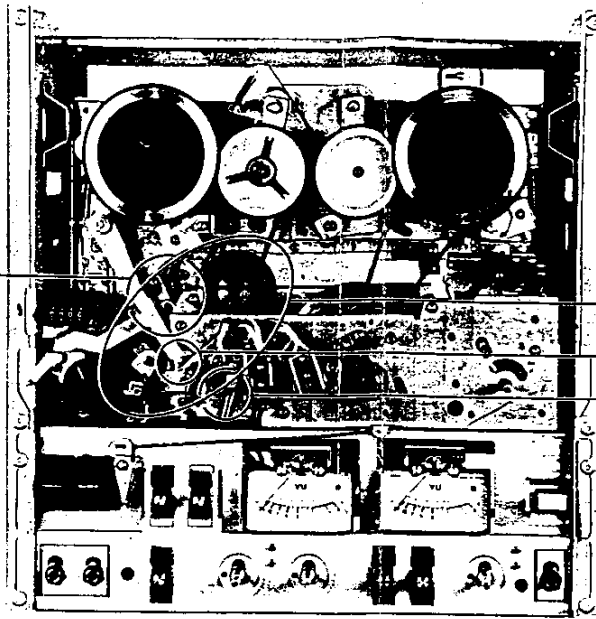

Shut-off Mechanism Adjustment

— stop mode —

1. Remove the head deck assembly.
2. Loosen two screws **A** and adjust the position of the shut-off lever holding plate assembly so that the shut-off mechanism is locked when the clearance between the shut-off arm end and head deck is 7 mm, and the shut-off mechanism is released completely when it is 3–5 mm.
3. Adjust screw **B** so that the clearance between shut-off levers (B) and (H) is 0.3–0.6 mm in stop mode.

dler

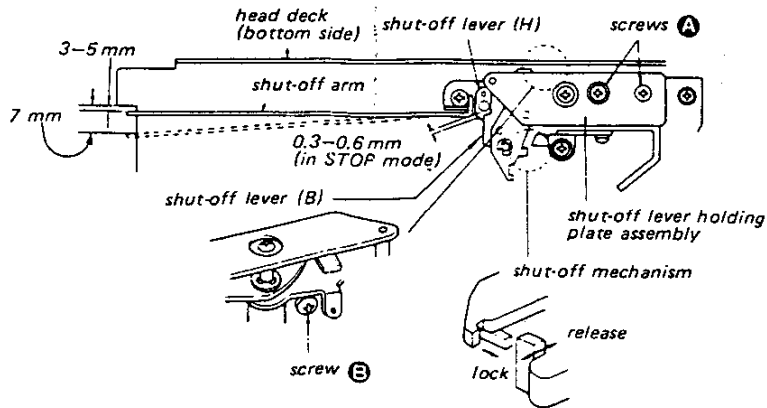

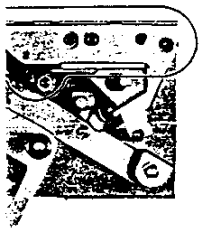
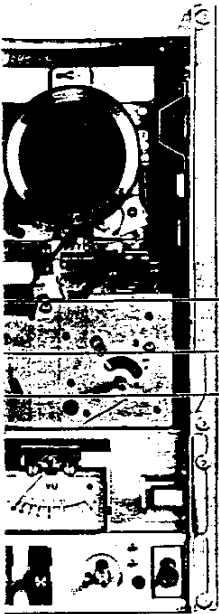

FOR SERVICE MANUALS
CONTACT:
MAURITRON TECHNICAL SERVICES

www.mauritron.co.uk
TEL: 01844 - 351694
FAX: 01844 - 352554

3. Adjust screw **B** so that the clearance between shut-off levers (B) and (H) is 0.3–0.6 mm in stop mode.

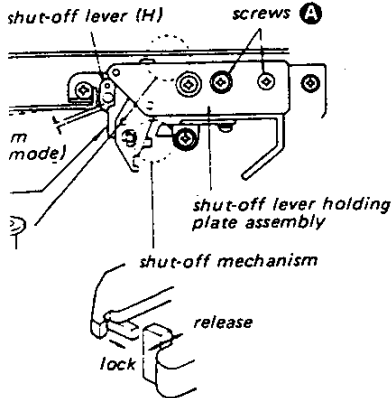

Capstan Idler Position Adjustment

– forward mode –

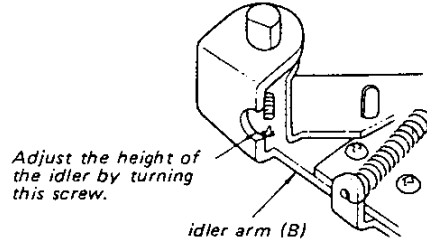
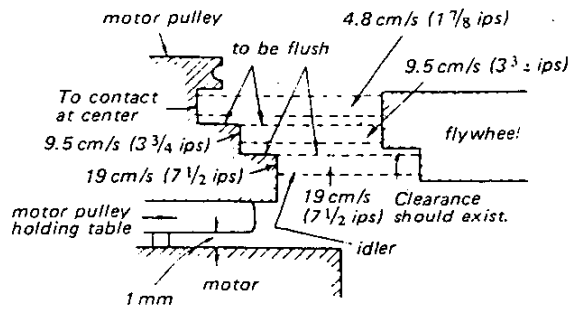

After the adjustment, the capstan idler should not come in contact with the flywheel and the 60 Hz motor pulley in stop mode and the clearance between the capstan idler and the 50 Hz motor pulley is more than 3 mm in stop mode.

Idler Arm (C) Stroke Check

– forward mode –

At 4.8 cm/s (1 7/8 ips) tape speed:

50 Hz	The clearance is 0.5–0.7 mm.
60 Hz	The clearance is 0.3–0.5 mm.

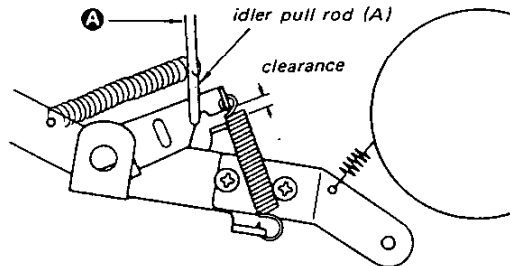

If necessary, bend the portion **A**.

Scrape Flutter Filter Roller Check

– forward mode –

At 4.8 cm/s (1 7/8 ips) tape speed.

0.1–0.3 mm

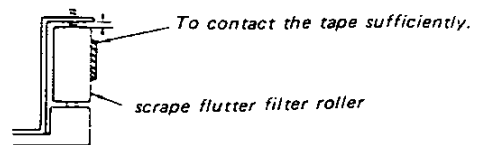

Fast Forward and Rewind Torque Adjustment

— fast forward and rewind modes —

Adjust the position of leaf spring to obtain the specified values on torque meter. (Read the values when the driving idler just stops.) As the leaf spring is positioned in lower position, the torque decrease.

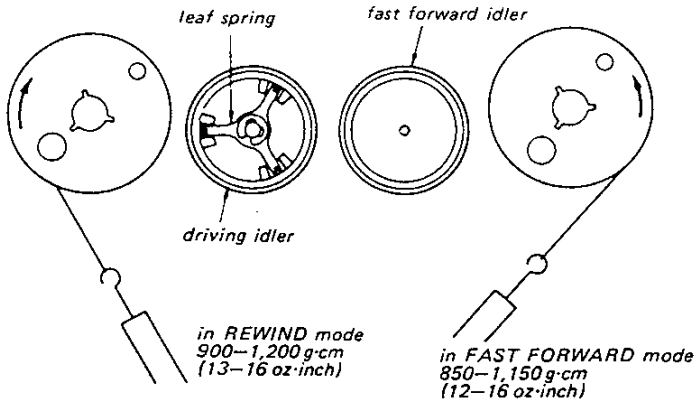

Forward Torque Adjustment

— forward mode —

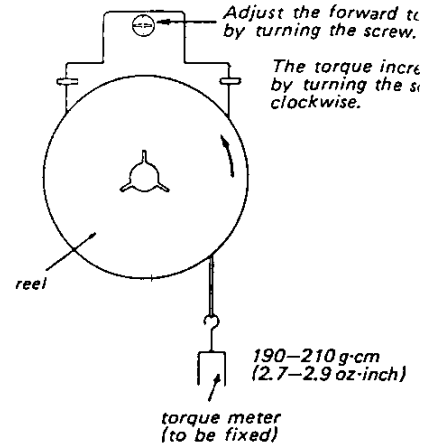

Fast Forward and Driving Idler Height Adjustment

— stop mode —

If necessary, bend the idler arms for the clearance.

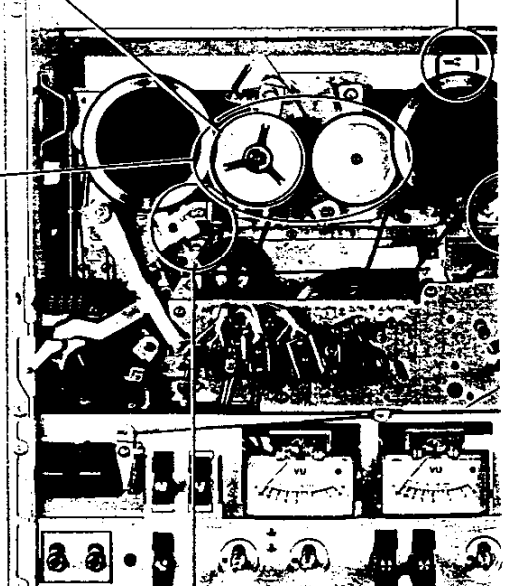
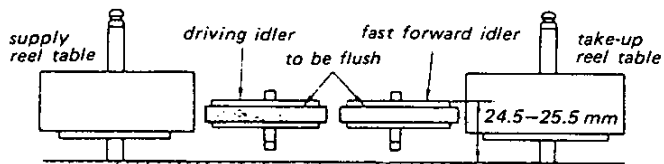

FOR SERVICE MANUALS
CONTACT:

MAURITRON TECHNICAL SERVICES

www.mauritron.co.uk
TEL: 01844 - 351694
FAX: 01844 - 352554

Adjustment

to obtain the
the values
leaf spring
decrease.

reel idler

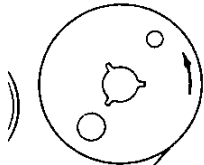

FAST FORWARD mode
0-1,150 g-cm
2-16 oz-inch

Forward Torque Adjustment

- forward mode -

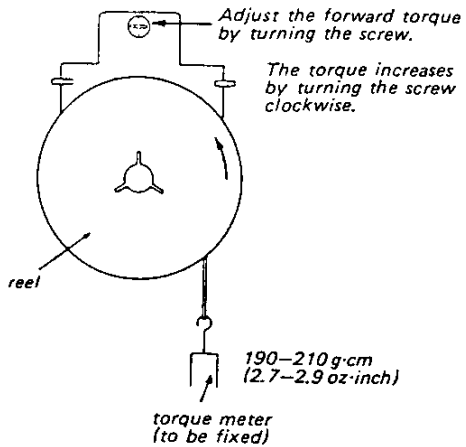

Adjustment

for the

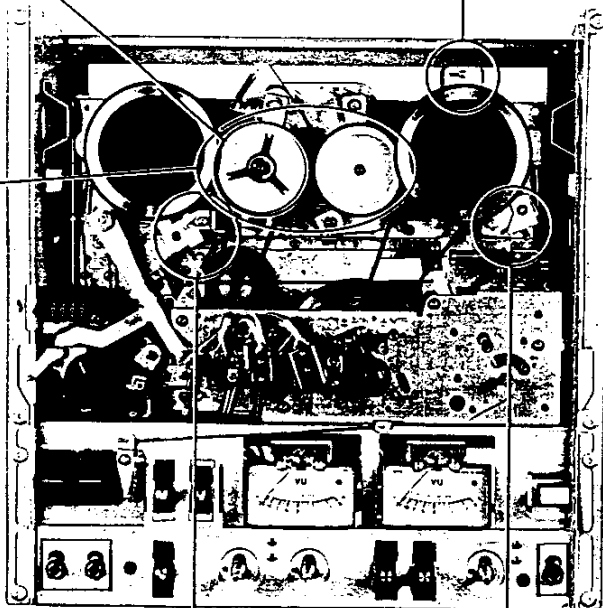
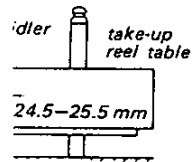

Brake Adjustment

- stop mode -

Note: After performing the Tension Reel Adjustment, adjust the supply torque.

supply brake torque	direction A	150-250 (2.09-3.4)
	direction B	1300-1700 (18.07-23.0)

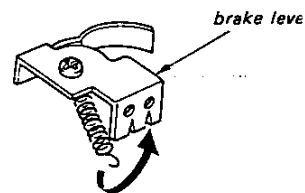
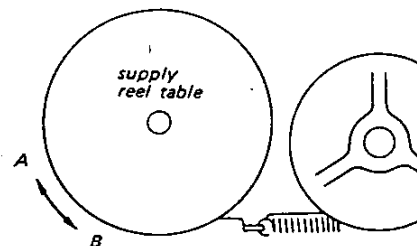

- If the meter reading is less than the specified value, hook the spring at the right hole.

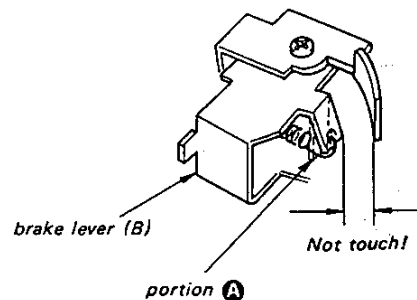

- If the meter reading is more than the specified value, bend the portion A.

Brake Adjustment

— stop mode —

Note: After performing the Tension Regulator Adjustment, adjust the supply brake torque.

supply brake torque	direction A	150–250 g·cm (2.09–3.47 oz·inch)
	direction B	1300–1700 g·cm (18.07–23.63 oz·inch)

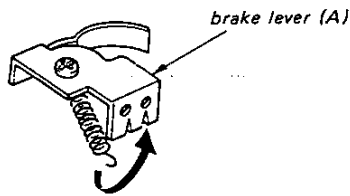
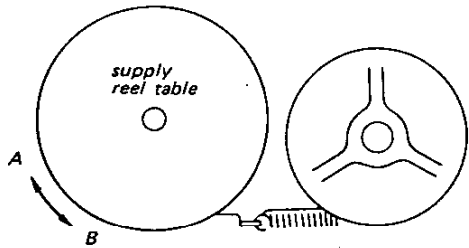

- If the meter reading is less than the specified value, hook the spring at the right hole.

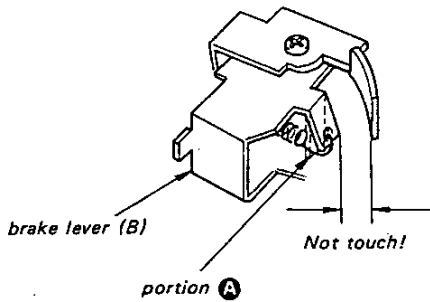

- If the meter reading is more than the specified value, bend the portion A.

take-up brake torque	direction C	350–450 g·cm (4.87–6.2 oz·inch)
	direction D	1300–1700 g·cm (18.07–23.63 oz·inch)

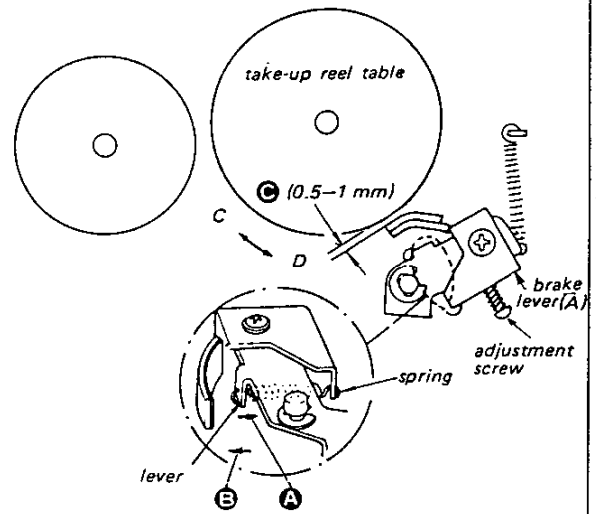

1. Turn the adjustment screw for the clearance **C** in record mode.
2. If necessary, bend the lever.

Meter reading	Bending direction
more than specified value	A
less than specified value	B

FOR SERVICE MANUALS
CONTACT:
MAURITRON TECHNICAL SERVICES

www.mauritron.co.uk
TEL: 01844 - 351694
FAX: 01844 - 352554

Flywheel Brake Check

— rewind mode —

1. The brake should touch the flywheel in both rewind and stop modes.
2. The break should separate from the flywheel in both forward and fast forward modes.

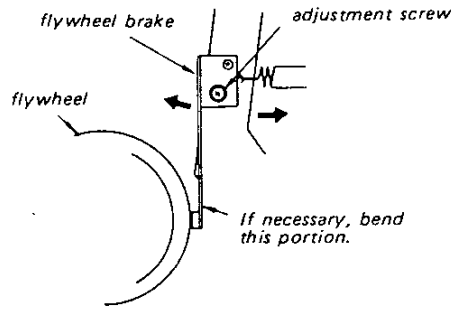

Motor Switch (S305) Position Adjustment

1. With the shut-off mechanism locked and a tape threaded, loosen the adjustment screw and adjust the position of the switch so that the switch turns on.
2. Push the shut-off arm in the direction **A**. The switch should turn off when the shut-off mechanism is released.

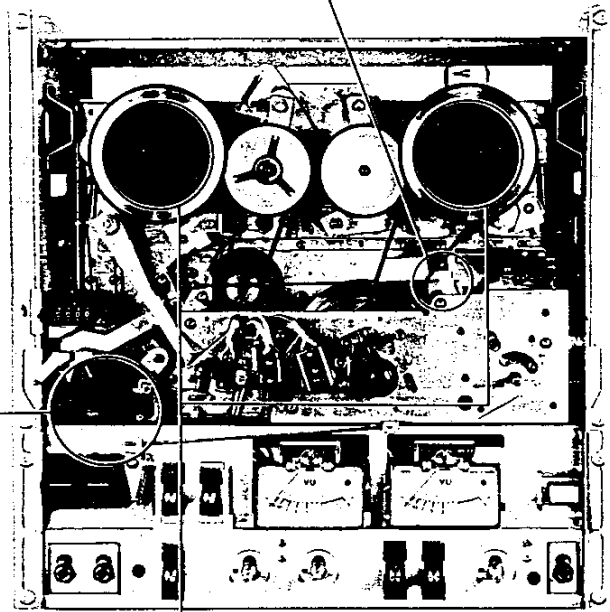
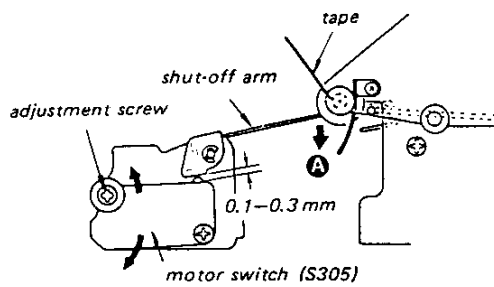

Reel Table Height Adjustment

— forward, rewind and fast forward modes —

Note: Perform this adjustment for both the supply and take-up reels.

1. Adjust the reel table height by bending the chassis with a screwdriver to eliminate the tape touch to the flanges by using a standard 7-inch tape reel.
2. In playback mode, confirm that the tape does not touch the reel flanges at the tape start and tape end.
3. After the adjustment, recheck the playback torque and back tension.

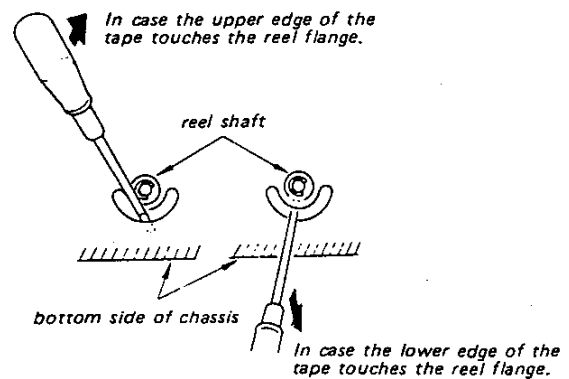

3-2. ELECTRICAL ADJUSTMENT

Note: When connecting the measuring equipments to the input or the output jack, take the impedance matching correctly.

Test Tape J-19-F2:

Tone	1	2	3	4	5	6	7
Frequency (Hz)	400	400	10 k	12.5 k	7 k	80	40
Level (dB)	0	-10	-10	-10	-10	-10	-10

Standard Record:

Set the REC LEVEL control for the specified output level.

Standard Input Level

	MIC	LINE IN
source impedance	300Ω	10 kΩ
input level	0.77 mV (-60 dB)	0.25 V (-10 dB)

Standard Output Level

	LINE OUT
load impedance	100 kΩ
output level	0.435 V (-5 dB)

Note on Replacing the Heads

1. Erase Head Removal
When removing the erase head from the head deck, remove the two screws shown with ▲. (Do not remove the three screws shown by ※.)
2. Record of Playback Head Removal
When removing the record or the playback head, remove the respective angle adjustment screws. (Do not turn the screws except the angle adjustment screws).

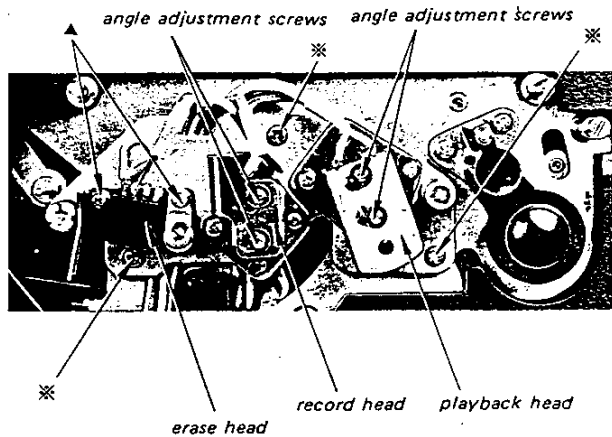

FOR SERVICE MANUALS
CONTACT:
MAURITRON TECHNICAL SERVICES
www.mauritron.co.uk
TEL: 01844 - 351694
FAX: 01844 - 352554

Tape Speed Adjustment

Settings:

TAPE SPEED selector: 19 cm/s (7 1/2 ips)
 MONITOR switch: TAPE
 PB LEVEL control: center-detented position

Procedure:

Mode: playback at 19 cm/s (7 1/2 ips)

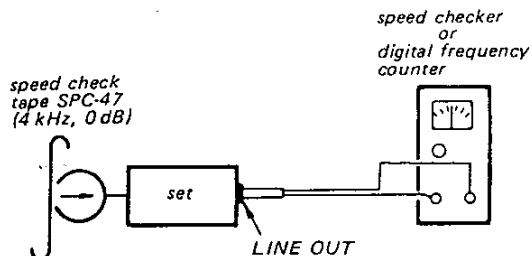

speed check tape SPC-47 (4 kHz, 0 dB)

no signal 4 min. → 4 kHz 2.5 min. → no signal 26 min.

Specification:

Speed checker	Digital frequency counter
1%	3,960–4,040 Hz

If necessary, replace the motor pulley.

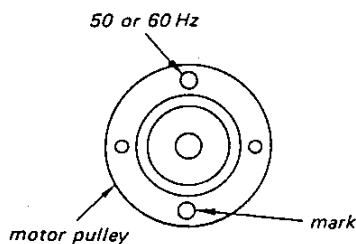

50 Hz		
Mark	Part No.	Tape speed
+2	3-518-067-61	+2% fast
+1	3-518-067-51	+1%
+0.5	3-518-067-41	+0.5%
0	3-518-067-01	standard
-0.5	3-518-067-11	-0.5%
-1	3-518-067-21	-1%
-2	3-518-067-31	-2% slow

60 Hz		
Mark	Part No.	Tape speed
+2	3-518-068-61	+2% fast
+1	3-518-068-51	+1%
+0.5	3-518-068-41	+0.5%
0	3-518-068-01	standard
-0.5	3-518-068-11	-0.5%
-1	3-518-068-21	-1%
-2	3-518-068-31	-2% slow

FOR SERVICE MANUALS
 CONTACT:
MAURITRON TECHNICAL SERVICES
 www.mauritron.co.uk
 TEL: 01844 - 351694
 FAX: 01844 - 352554

Adjustment Location:

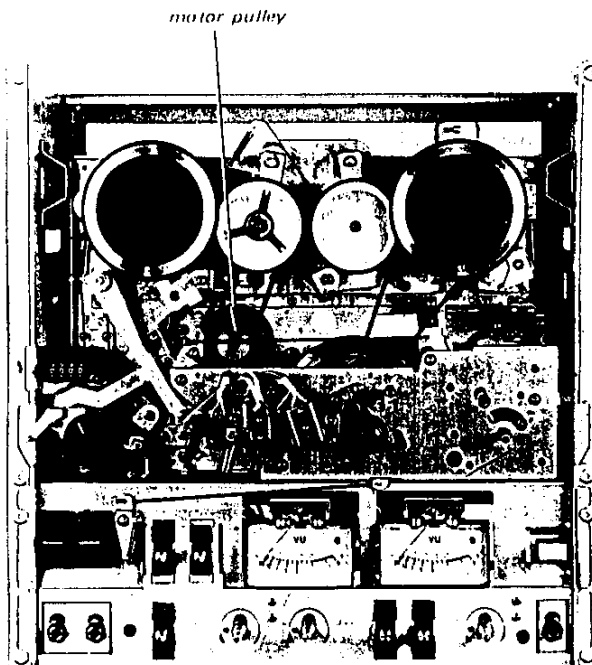

Tape Path Adjustment

A. Tape Guide (left) Adjustment

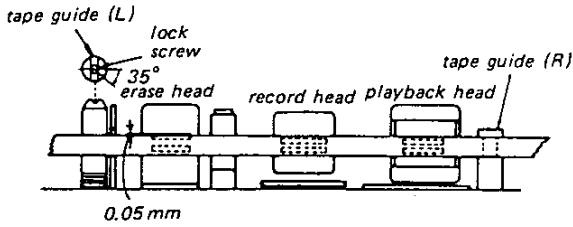

Procedure:

1. Thread a tape and place the set in playback mode.
2. Loosen the lock screw and align the upper edge of the erase head core and that of the tape by turning the tape guide (L).
3. Turn the tape guide (L) clockwise by approximately 35 degrees from the position obtained in the preceding step so that the upper edge of the tape is approximately 0.05 mm lower than the upper edge of the erase head core.
4. Fix the tape guide with the lock screw.

Adjustment Location:

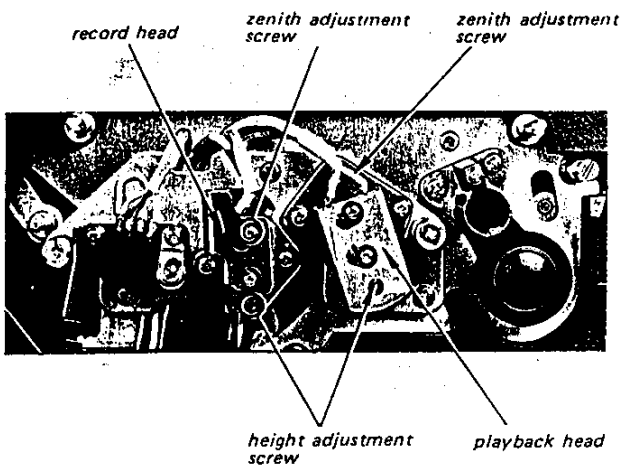

B. Record and Playback Head Preadjustment
(Rough adjustment for the Playback Head Angle Adjustment and Playback Head Azimuth Adjustment)

Note: This adjustment and the following adjustments (Playback Head Angle Adjustment and Playback Head Azimuth Adjustment) should be repeated alternately several times.

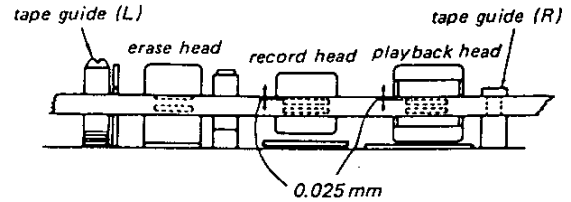

Procedure:

1. Align the upper edges of the record and playback head cores and that of the tape by evenly turning the record and playback head height adjustment screws.
2. Turn the record and playback head height adjustment screws clockwise by approximately 15 degrees so that the upper edges of the record and playback head cores are 0.025 mm lower than that of the tape and memorize the angle of turns.
3. Turn the zenith adjustment screws by the same angle of turns to the same direction as the record and playback head height adjustment screws.
4. Thread the tape Super 150 or PS-2 and place the set in playback mode at 19 cm/s (7 1/2 ips).
5. Make the tape loose a little by pushing the tension regulator arm pin in the direction shown by the arrow and then adjust the playback head and record head zenith adjustment screws to obtain the reflection of light as shown below.

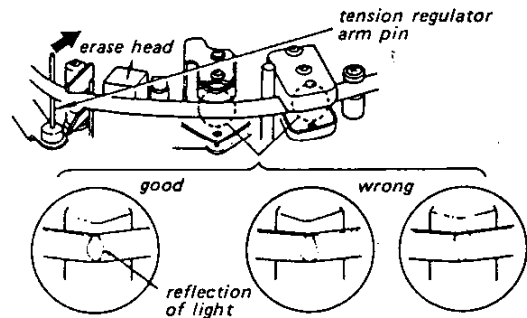

Tape Curl Adjustment

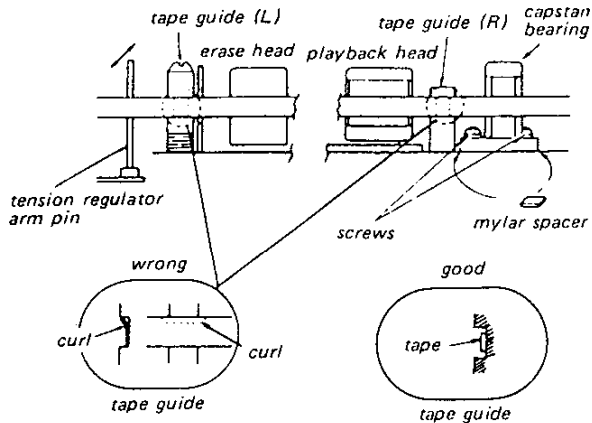

Procedure:

1. Thread the tape Super 200 (thin tape) and place the set in playback mode at 4.8 cm/s (1 7/8 ips).
2. Be sure that the tape comes in contact with the two tape guides exactly as shown above.
 - a) If the tape curls at the tape guide (L), adjust by bending the tension regulator arm pin.
 - b) If the tape curls at the tape guide (R), loosen the two capstan bearing holding screws and adjust by adding or removing the mylar spacer.

Note: After adding or removing the mylar spacer (0.1 mm thick), perform the playback head zenith adjustment. (See "Record and Playback Head Preadjustment" on page 16.)

FOR SERVICE MANUALS
CONTACT:
MAURITRON TECHNICAL SERVICES
www.mauritron.co.uk
TEL: 01844 - 351694
FAX: 01844 - 352554

Playback Head Angle Adjustment

Settings:

TAPE SELECT EQ switch: NORMAL
TAPE SPEED selector: 19 cm/s (7 1/2 ips)
MONITOR switch: TAPE
PB LEVEL control: center-detented position

Procedure:

1. Mode: playback

test tape
J-19-F2
4th tone
(12.5 kHz, -10 dB)

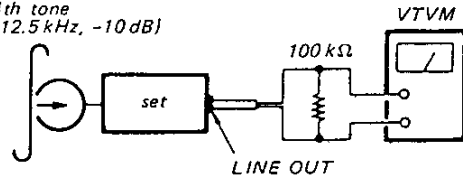

2. Adjust the angle-adjustment screws for a maximum reading.
3. Apply back-tension by holding the supply reel table, and then adjust the angle of the head by loosening the two angle-adjustment screws so that the readings on both L-CH and R-CH do not rise.

Note: Unless the playback head is installed at correct angle, the readings will rise.

Adjustment Location:

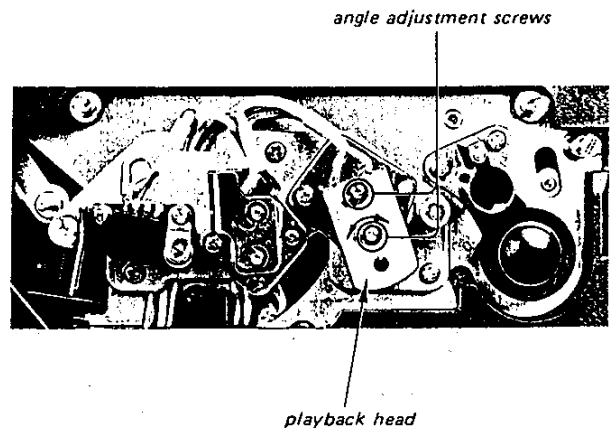

Playback Head Azimuth Adjustment

Settings:

- TAPE SELECT EQ switch: NORMAL
- TAPE SPEED selector: 19 cm/s (7½ ips)
- MONITOR switch: TAPE
- PB LEVEL control: center-detented position

Procedure:

1. Be sure that the playback head is fixed sufficiently to the head deck with the holding screw as shown below and "Tape Path Adjustment" has been made.
2. Mode: playback

test tape
J-19-F2
4th tone (12.5 kHz, -10 dB)

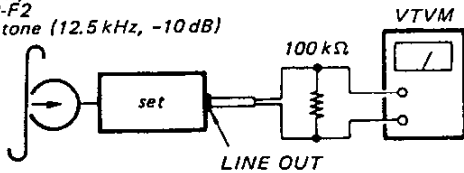

3. Turn the azimuth adjustment screw for the maximum level and set it to the mechanical mid position between L-CH and R-CH peak positions.

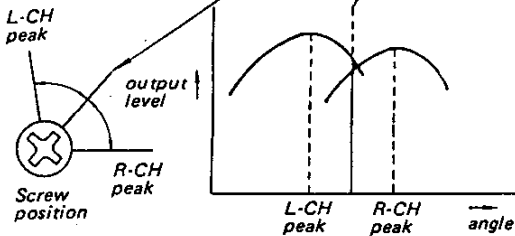

4. Mode: playback

test tape
J-19-F2
3rd tone
(10 kHz, -10 dB)

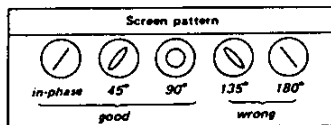
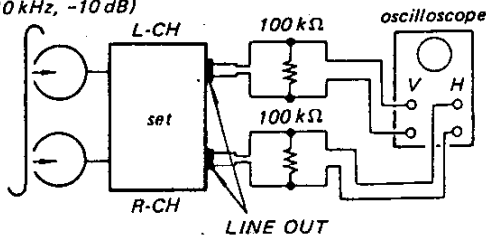

FOR SERVICE MANUALS
CONTACT:

MAURITRON TECHNICAL SERVICES

www.mauritron.co.uk

TEL: 01844 - 351694

FAX: 01844 - 352554

Adjustment Location:

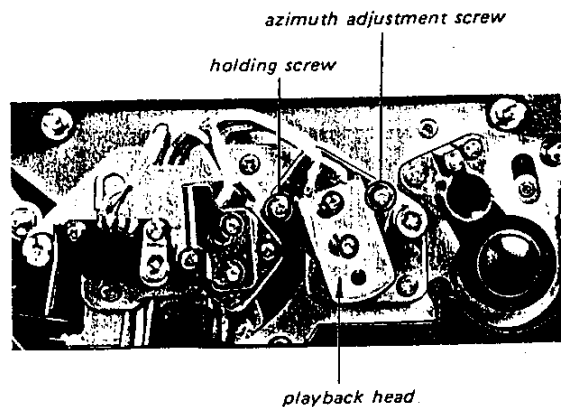

Playback Level Adjustment

Settings:

TAPE SELECT EQ switch: NORMAL
 TAPE SPEED selector: 19 cm/s (7 1/2 ips)
 MONITOR switch: TAPE
 PB LEVEL control: center-detented position

Procedure:

1. Mode: playback

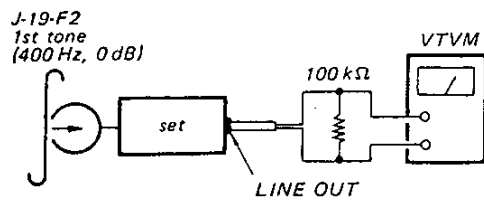

2. Adjust RV104 (L-CH) and RV204 (R-CH) for 0.435 V (-5 dB) reading.

Adjustment Location:

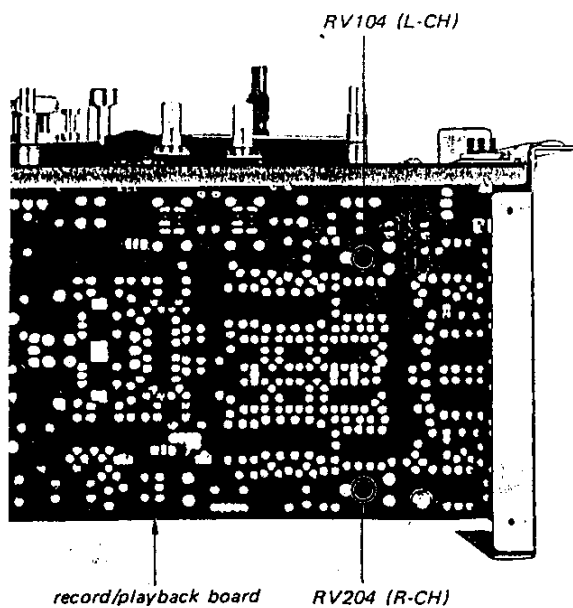

VU Meter Calibration

Setting:

MONITOR switch: SOURCE

Procedure:

1. Mode: record

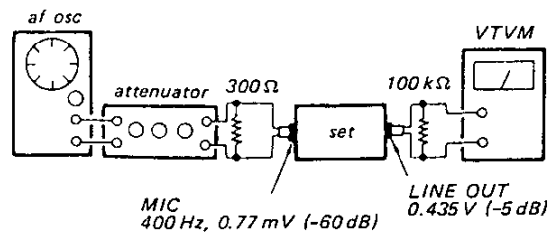

2.

Adjust	VU meter indication
RV106 (L-CH) RV206 (R-CH)	"0"

Adjustment Location:

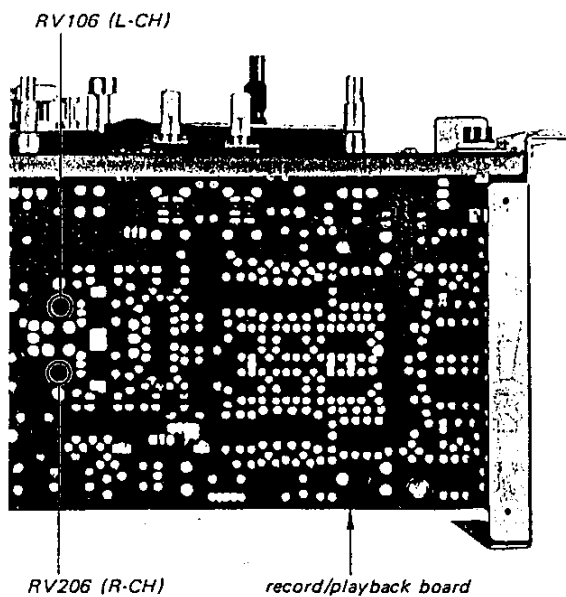

FOR SERVICE MANUALS
 CONTACT:

MAURITRON TECHNICAL SERVICES

www.mauritron.co.uk

TEL: 01844 - 351694

FAX: 01844 - 352554

Record Head Azimuth and Track Position Adjustment

Settings:

- TAPE SELECT switch: SPECIAL
- TAPE SPEED selector: 19 cm/s (7½ ips)
- MONITOR switch: TAPE

Procedure:

1. Mode: standard record and simultaneous playback

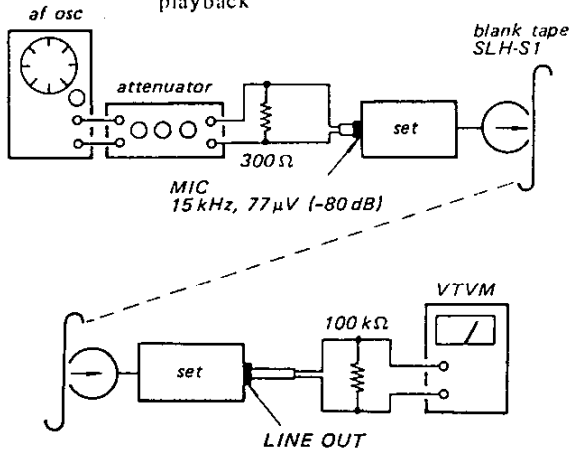

2. Turn the azimuth adjustment screw for the maximum level and set it to the mechanical mid position between L-CH and R-CH peak positions.

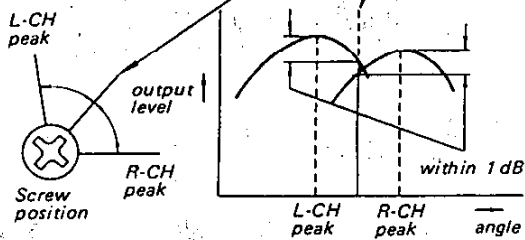

3. Supply a 1 kHz signal of 0.77 mV (-60 dB) into R-CH MIC jack and record and simultaneously playback the signal with the blank tape.
4. Adjust the height adjustment screw for the maximum output and memorize the angle of turns of the screw.
5. Turn the zenith adjustment screw by the same angle of turns obtained in preceding step 4.
6. After the adjustment, check Tape Path Adjustment on page 16 again.

Adjustment Location:

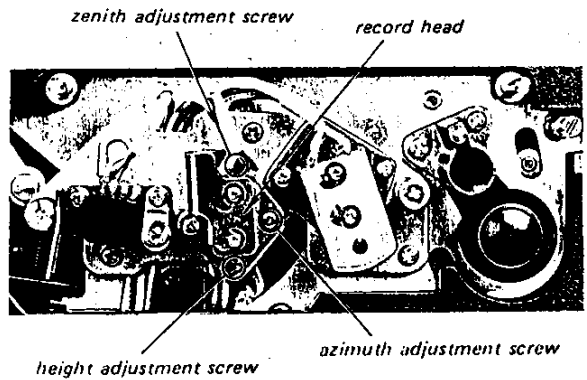

Bias Trap Coil Adjustment

Settings:

TAPE SELECT switch: NORMAL
 TAPE SPEED selector: 19 cm/s (7½ ips)
 MIC REC LEVEL control: minimum position
 MONITOR switch: SOURCE

Procedure:

1. Do not use a shielded lead wire.
2. Place the set in record mode without tape.
3. Adjust L103 (L-CH) and L203 (R-CH) to obtain the minimum reading.

Adjustment Location:

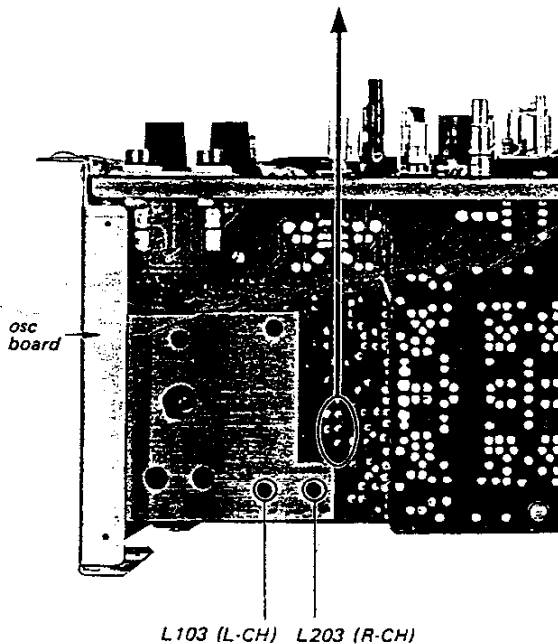
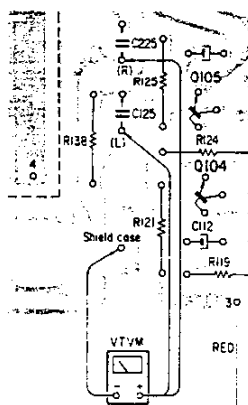

Record Bias Adjustment

Settings:

TAPE SELECT switch: SPECIAL
 TAPE SPEED selector: 19 cm/s (7½ ips)
 MONITOR switch: TAPE

Procedure:

1. Be sure that "Bias Trap Coil Adjustm. been made.
2. Mode: standard record and simu playback

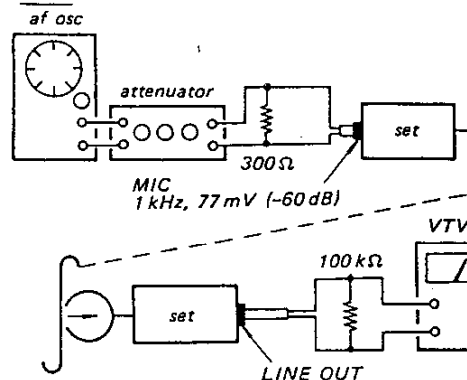

3. As trimmer capacitor C128 (L-CH) (R-CH) is slowly turned clockwise, the will go up to a maximum and then start again. Adjust the capacitor until the reads 0.5 dB below and beyond the m reading.

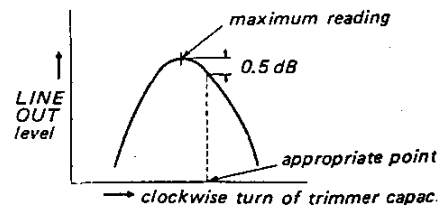

FOR SERVICE MANUALS
 CONTACT:
MAURITRON TECHNICAL SERVICES
 www.mauritron.co.uk
 TEL: 01844 - 351694
 FAX: 01844 - 352554

Record Bias Adjustment

Settings:

TAPE SELECT switch: SPECIAL
 TAPE SPEED selector: 19 cm/s (7½ ips)
 MONITOR switch: TAPE

Procedure:

1. Be sure that "Bias Trap Coil Adjustment" has been made.
2. Mode: standard record and simultaneous playback

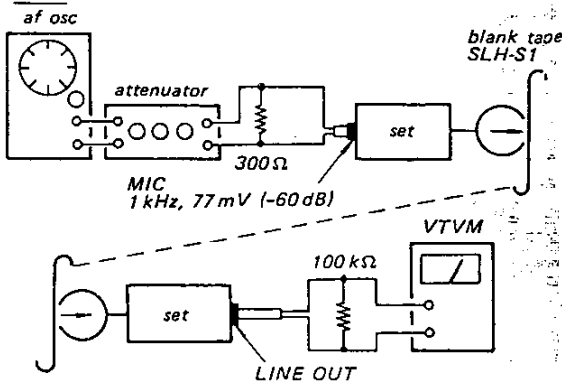

3. As trimmer capacitor C128 (L-CH) or C228 (R-CH) is slowly turned clockwise, the reading will go up to a maximum and then start falling again. Adjust the capacitor until the VTVM reads 0.5 dB below and beyond the maximum reading.

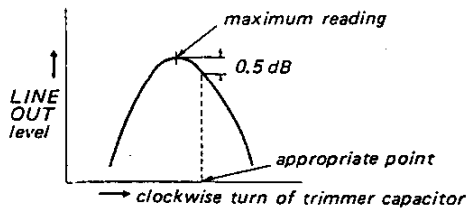

4. Mode: standard record and simultaneous playback

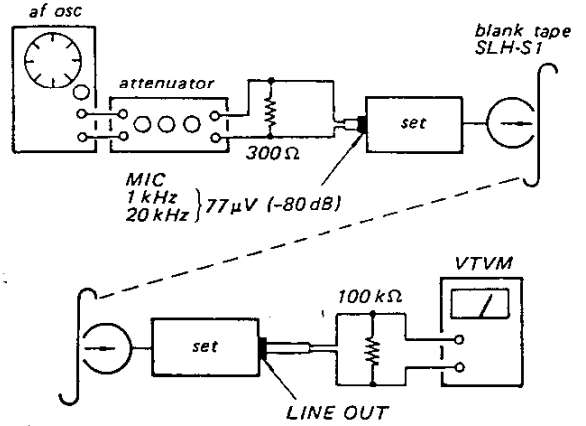

The LINE OUT level of 20 kHz signal is -3 dB-0 dB relative to 1 kHz signal level.

Adjustment Location:

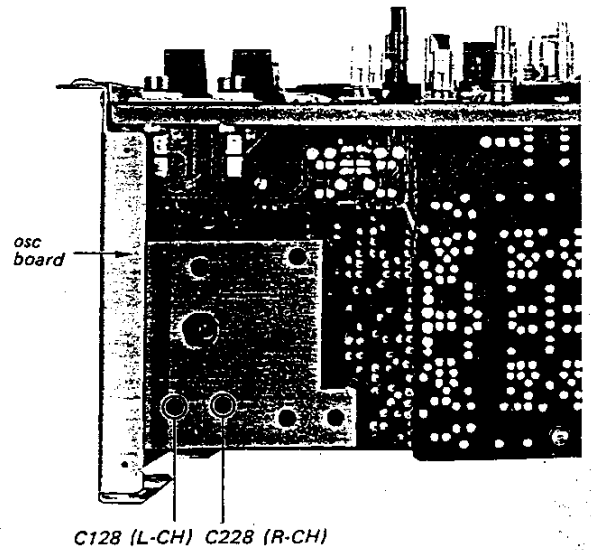

NORMAL
 19 cm/s (7½ ips)
 SOURCE

ad wire.
 mode without tape.
 and L203 (R-CH) to
 ding.

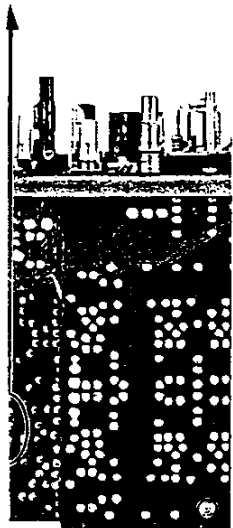
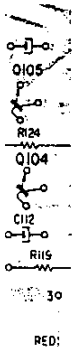

(R-CH)

4. Mode: standard record and simultaneous playback

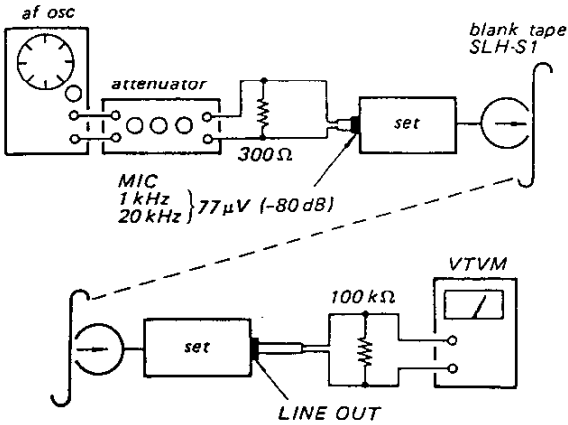

The LINE OUT level of 20 kHz signal is -3 dB-0 dB relative to 1 kHz signal level.

Adjustment Location:

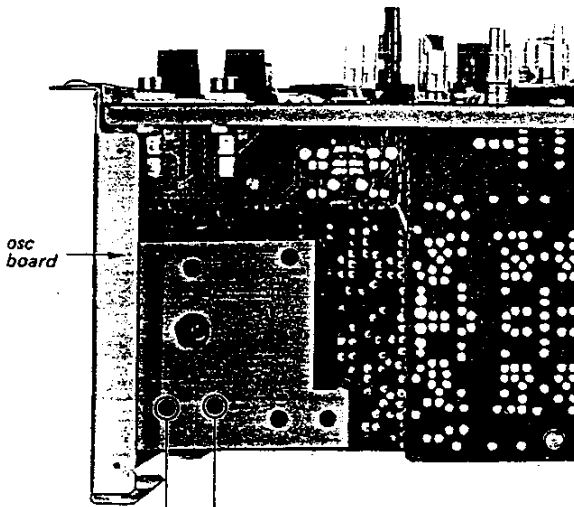

C128 (L-CH) C228 (R-CH)

FOR SERVICE MANUALS
CONTACT:
MAURITRON TECHNICAL SERVICES
www.mauritron.co.uk
TEL: 01844 - 351694
FAX: 01844 - 352554

Record Level Adjustment

Setting:

- TAPE SELECT switch: SPECIAL
- TAPE SPEED selector: 19 cm/s (7 1/2 ips)
- MONITOR switch: TAPE

Procedure:

1. Mode: standard record and simultaneous playback

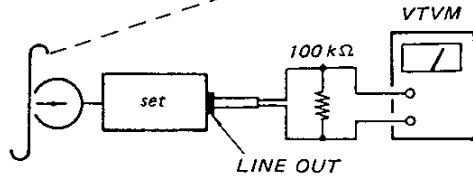
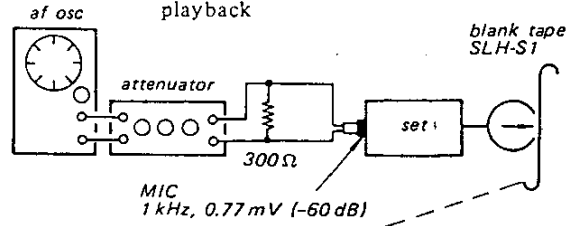

2. Adjust RV103 (L-CH) and RV203 (R-CH) for 0.435 V (-5 dB) reading.
3. Be sure that the reading is 0.435 V (-5 dB) when changing the MONITOR switch from TAPE to SOURCE position and the pointer of VU meter stays at "0".
4. When TAPE SPEED switch is changed to 9.5 cm/s (3 3/4 ips) and 4.8 cm/s (1 7/8 ips), the readings of both L and R channels should be within 2 dB.

Adjustment Location:

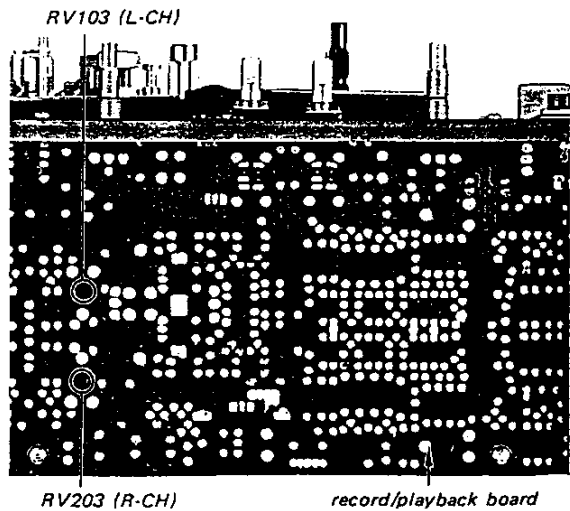

RV203 (R-CH)

record/playback board

Dummy

Setting:

- TA
- TA
- MC

Procedure:

Mc

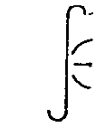
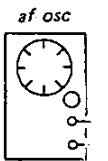

Step
1
2
3

Adjustme

L1
(ad,
for



osc board

ment

switch: SPECIAL
 selector: 19 cm/s (7½ ips)
 ch: TAPE

record and simultaneous

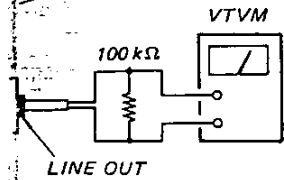
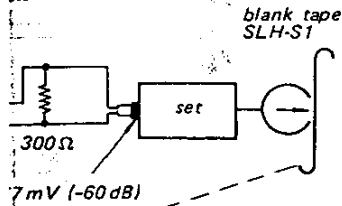

(L-CH) and RV203 (R-CH) for reading.

reading is 0.435 V (-5 dB) when MONITOR switch from TAPE position and the pointer of VU "0".

SPEED switch is changed to 19 cm/s (7½ ips) and 4.8 cm/s (1⅞ ips), the L and R channels should be

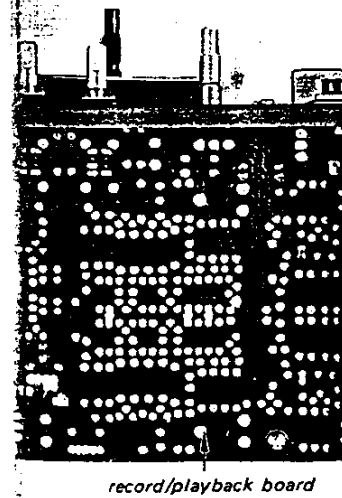

Dummy Coil Adjustment

Setting:

TAPE SELECT switch: NORMAL
 TAPE SPEED selector: 19 cm/s (7½ ips)
 MONITOR switch: TAPE

Procedure:

Mode: standard record and simultaneous playback

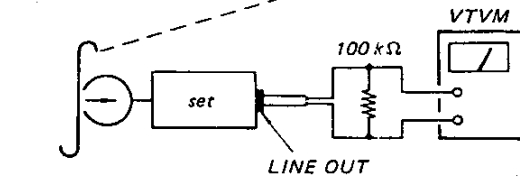
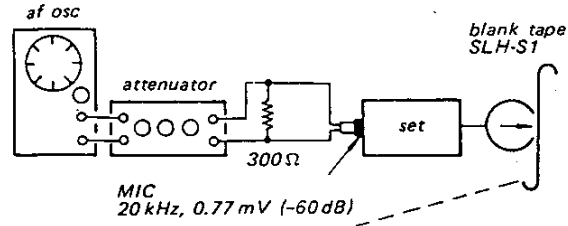

Step	Mode	Adjust	Remarks
1	stereo record and simultaneous playback	-	Memorize VTVM reading.
2	L channel record and simultaneous playback	L204	Same VTVM reading as in step 1.
3	R channel record and simultaneous playback	L104	

Adjustment Location:

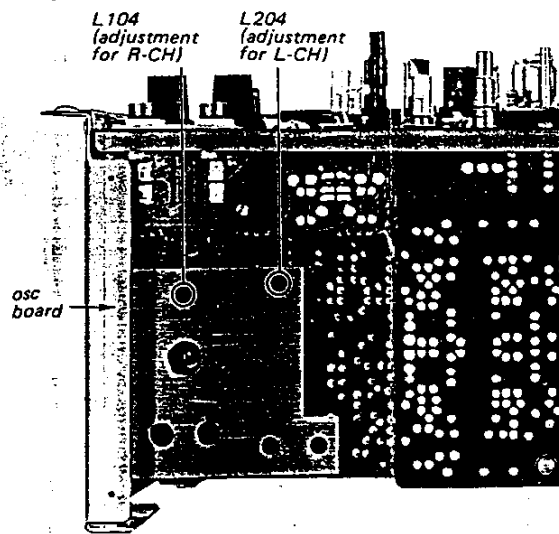

FOR SERVICE MANUALS
 CONTACT:
MAURITRON TECHNICAL SERVICES
 www.mauritron.co.uk
 TEL: 01844 - 351694
 FAX: 01844 - 352554

SECTION 4 DIAGRAMS

4-1. MOUNTING DIAGRAM

Replacement Semiconductors

For replacement, use semiconductors except in ().

Q101, 201
Q102, 202
Q106, 206
Q107, 207
Q109, 209
Q103-105
Q203-205
Q110, 210
Q113, 213
: 2SC1345
: 2SC1345 (2SC458)

Q304: 2SC1173

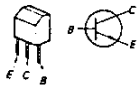
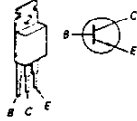

D101, 201, 305: 1T22AM (1T22)
D304, 306: 1S1555 (1T40)

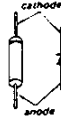

Q114, 214
Q306
: 2SC1475 (2SC1318)

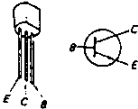

D301, 302: 10E2 (SIB01-02)
D303: RD11E (EQA01-11S)

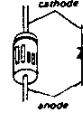

Q302, 303: 2SC1345 (2SC1890)

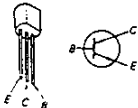
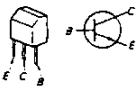

Q108, 208
Q111, 211
Q112, 212
Q305
: 2SC1364 (2SC633A)

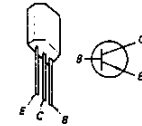
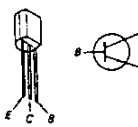

Q301: 2SK30 (2SK30A)

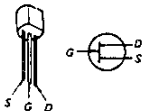

Note:

- ~~WHT~~ : B+ pattern.
- Signal Path
- \dashrightarrow : L-CH
- \dashrightarrow : R-CH
- DC resistance measurements are with coils connected on the circuit board, and are approximate.
- Color code of sleeving over the end of the jacket.

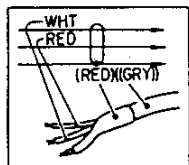

FOR SERVICE MANUALS
CONTACT:
MAURITRON TECHNICAL SERVICES
www.mauritron.co.uk
TEL: 01844 - 351694
FAX: 01844 - 352554

US, CANADIAN MODEL

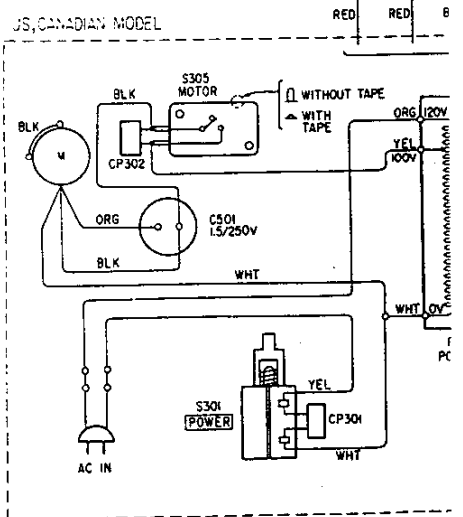

SECTION 4 DIAGRAMS

1304: 2SC1173

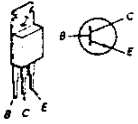

1305: 1T22AM (1T22)
1306: 1S1555 (1T40)

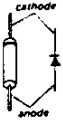

1307: 10E2 (S1B01-02)
1308: RD11E (EQA01-11S)



2

4

5

US, CANADIAN MODEL

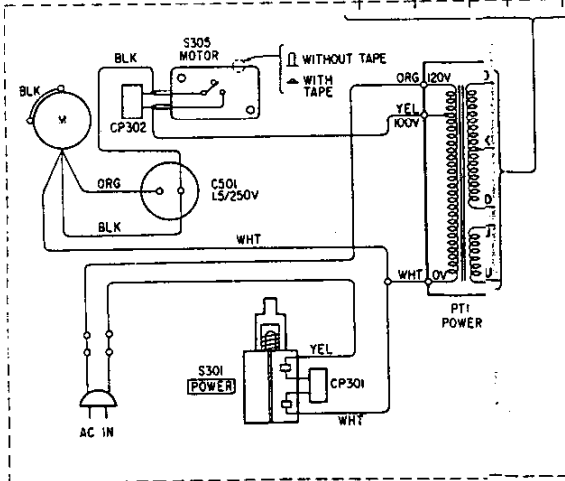

with coils connected on
rimate.
end of the jacket.

[TAPE SPEED
SWITCH BOARD]

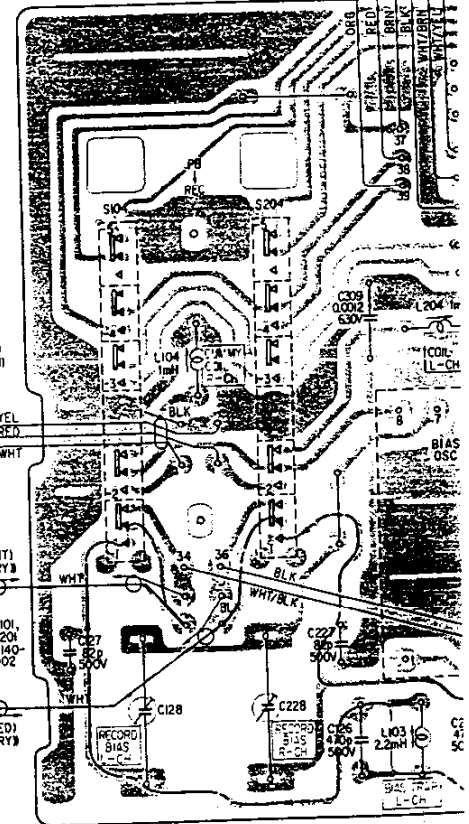
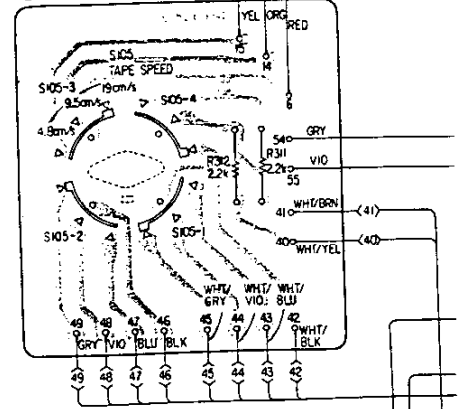

[OSC BOARD]

Q, IC	
D	

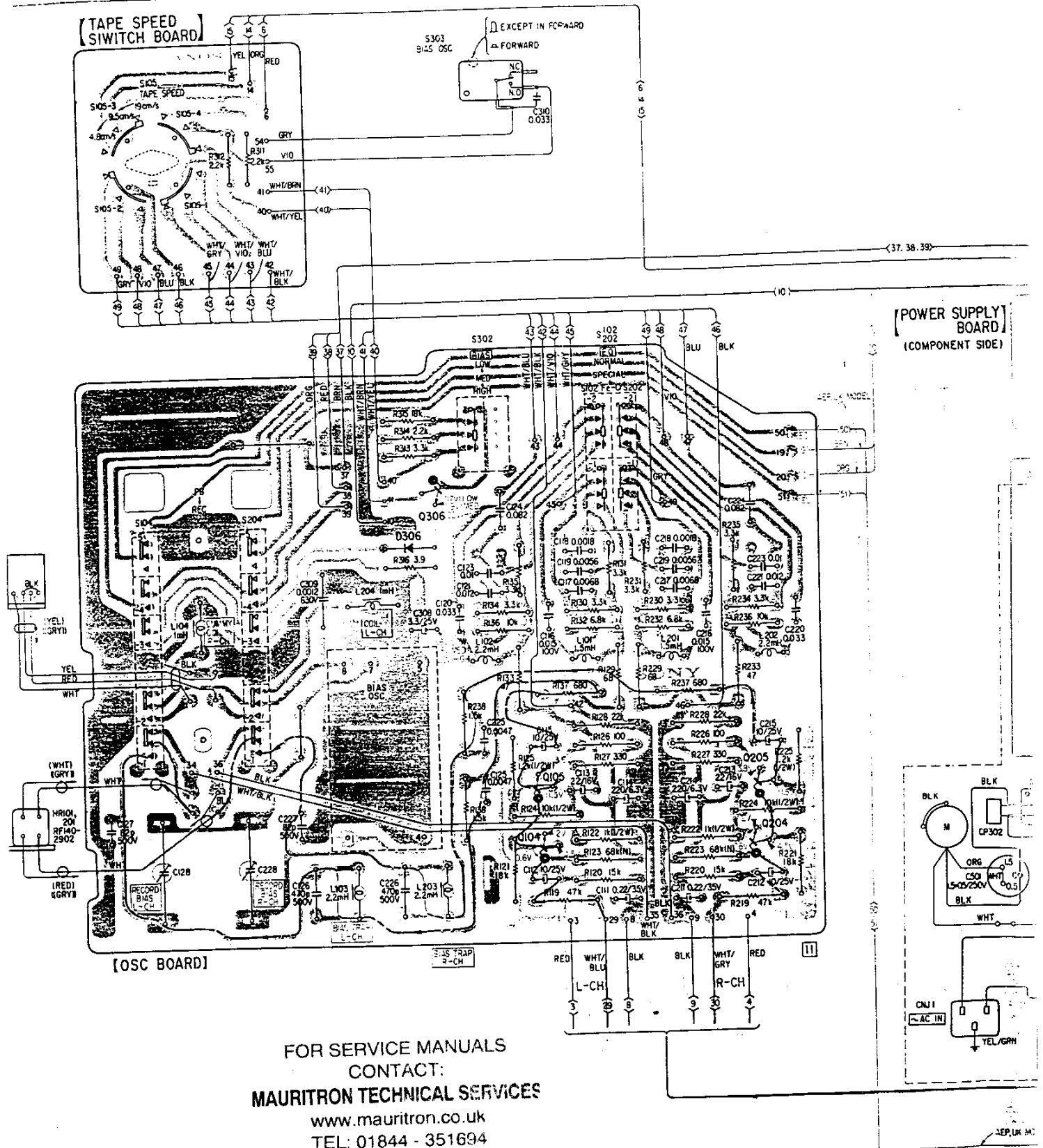

Q, IC	306	105	205
D	306	104	204

[METER BOARD]

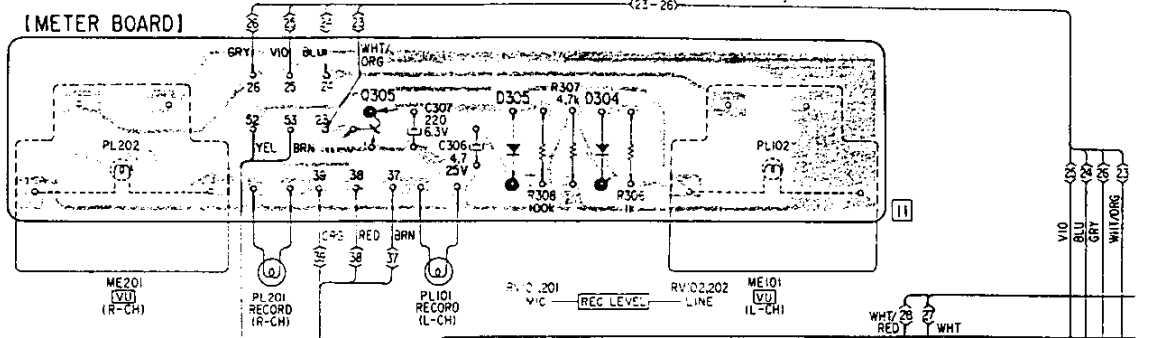

[POWER SUPPLY BOARD (COMPONENT SIDE)]

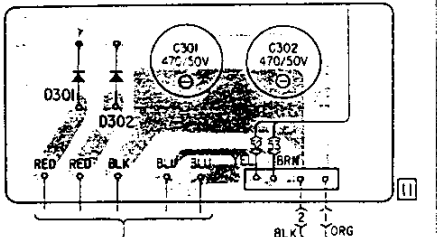

[FUSE BOARD]

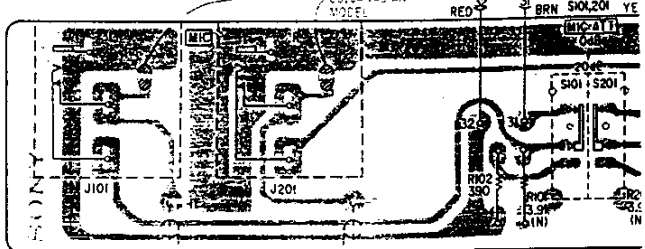
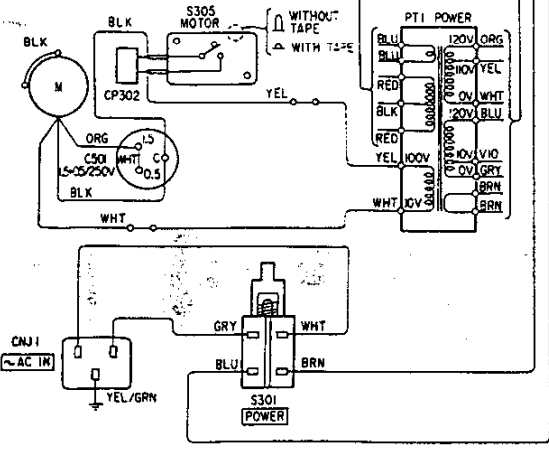
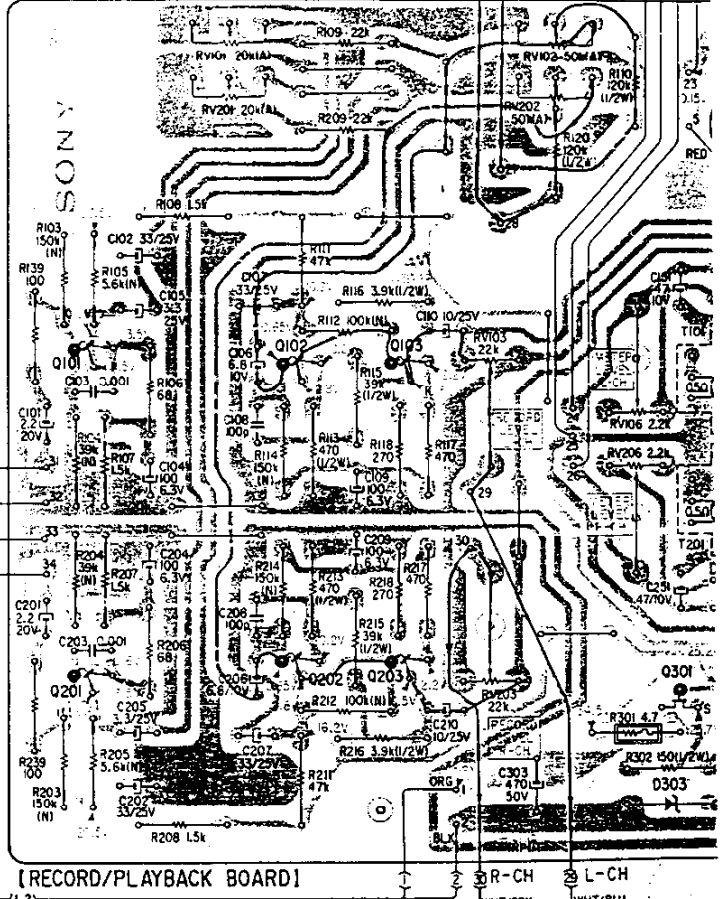
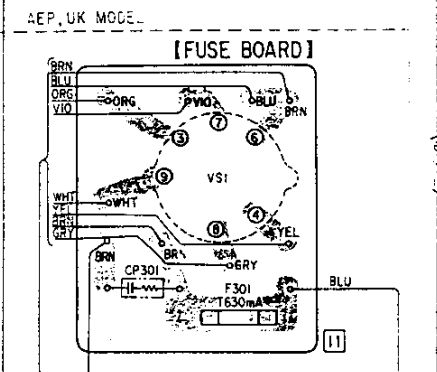

305	101	102	103	301
	201	202	203	
301 302	305 304			303

FOR SERVICE MANUALS
 CONTACT:
MAURITRON TECHNICAL SERVICES
 www.mauritron.co.uk
 TEL: 01844 - 351694
 FAX: 01844 - 352554

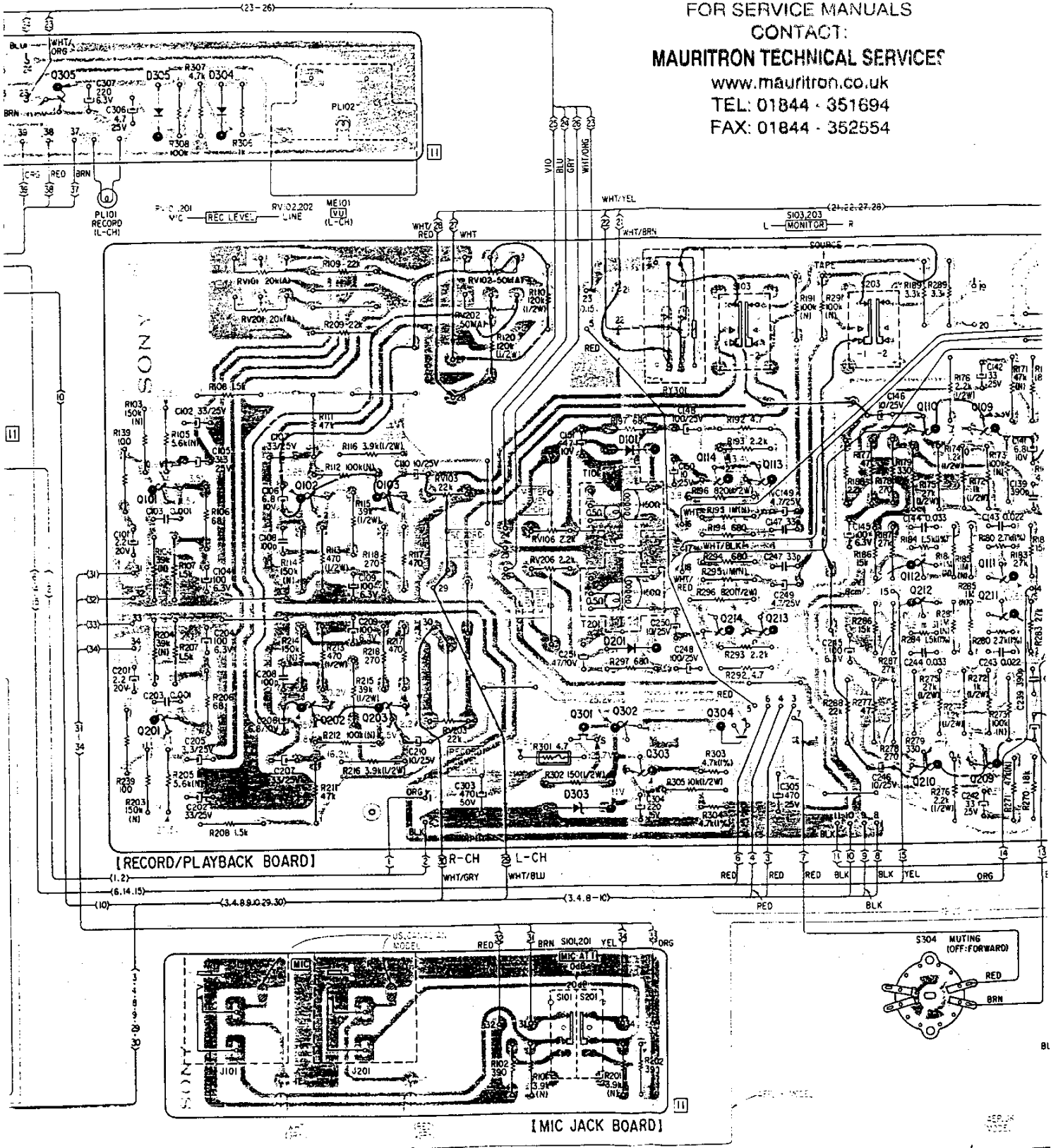

305	101	102	103	301	302	114	113	110	109
	201	202	203		303	214	213	112	111
	305	304		303	201	304		210	209

FOR SERVICE MANUALS
 CONTACT:
MAURITRON TECHNICAL SERVICES
 www.mauritron.co.uk
 TEL: 01844 - 351694
 FAX: 01844 - 352554

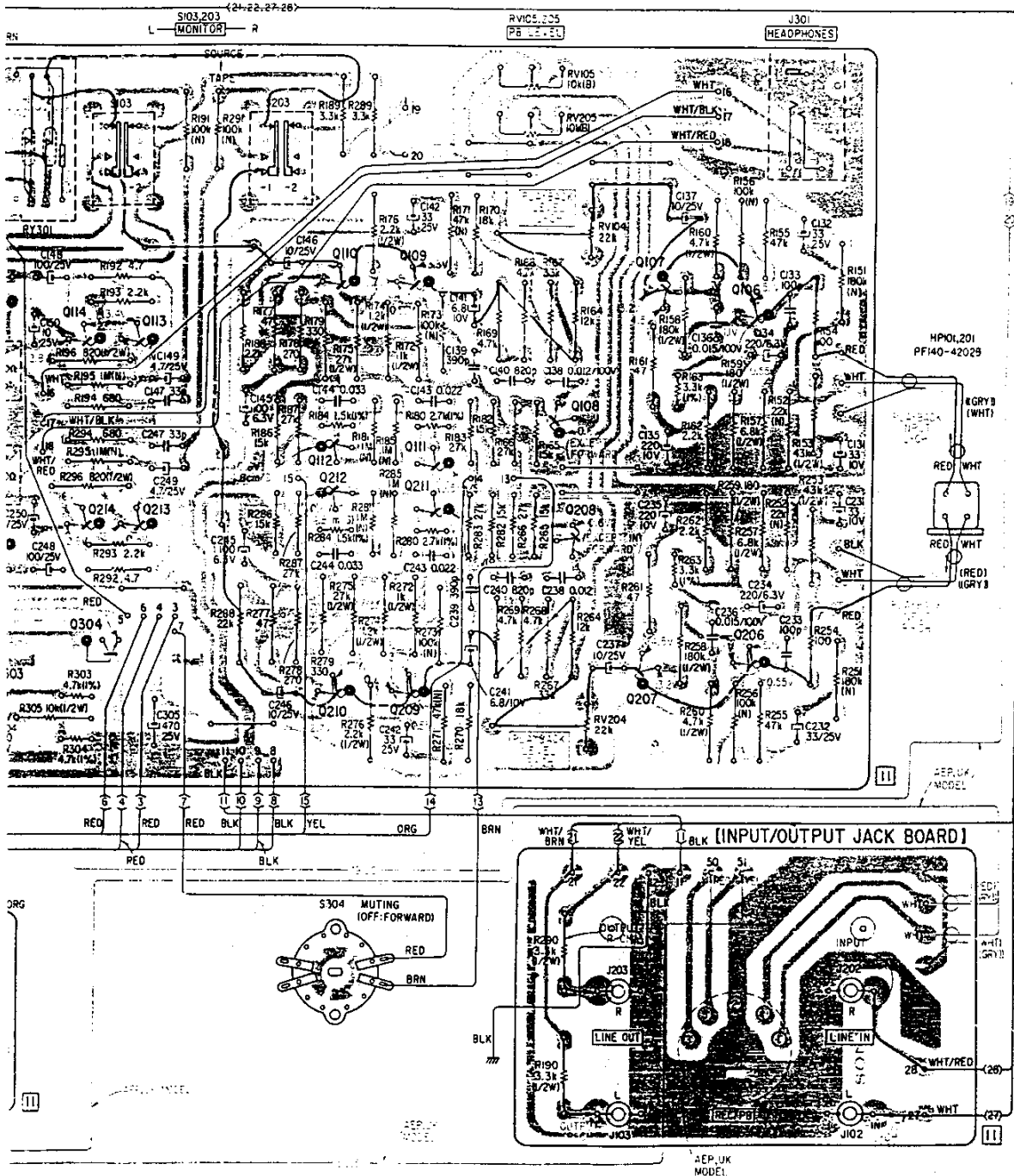

114	113	110	109				
214	213	112	111	108	107	106	Q, IC
304		212	211	208	207	206	
		210	209				D

4-2. SCHEMATIC DIAGRAM

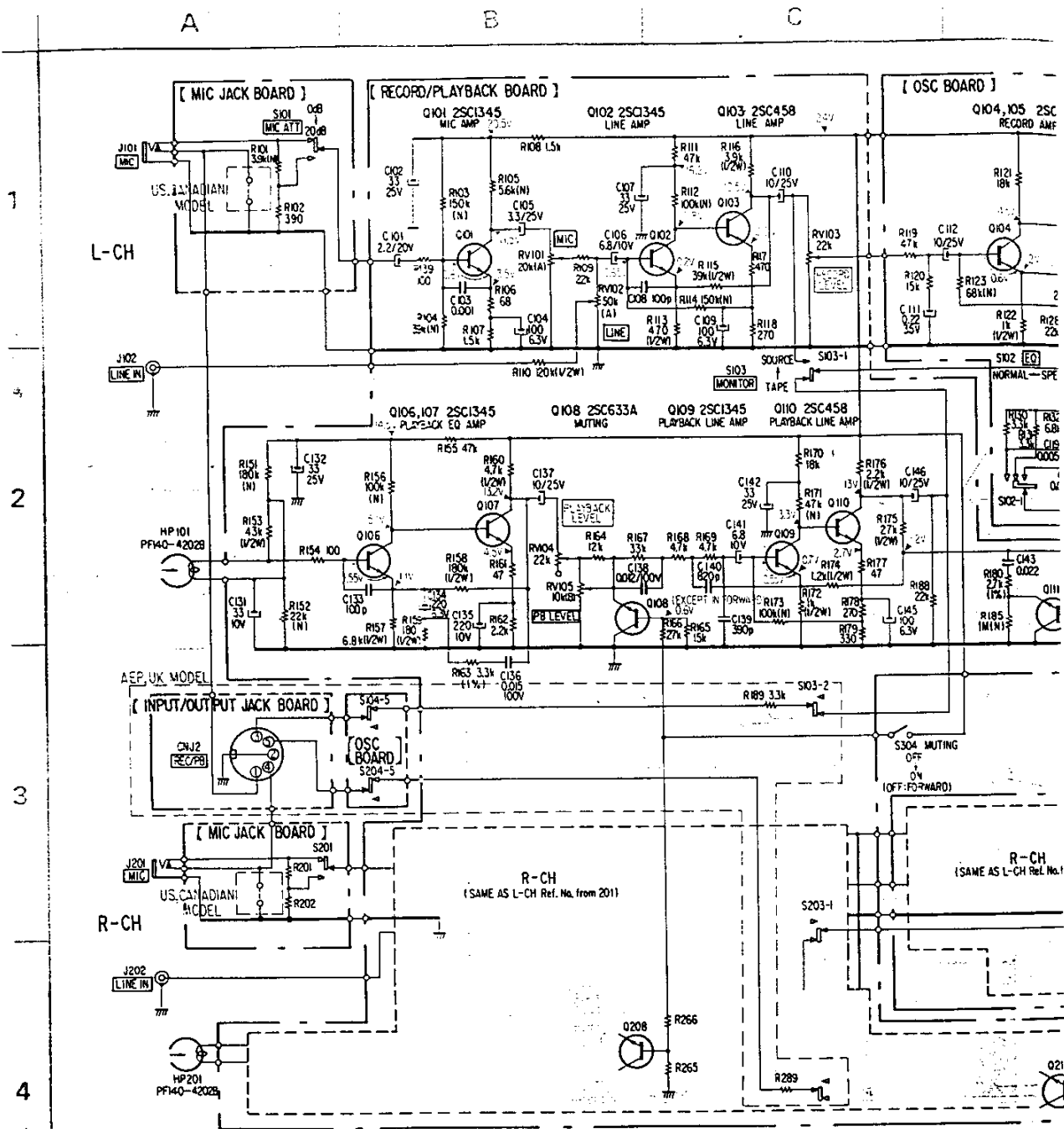

FOR SERVICE MANUALS
CONTACT:
MAURITRON TECHNICAL SERVICES
www.mauritron.co.uk
TEL: 01844 - 351694
FAX: 01844 - 352554

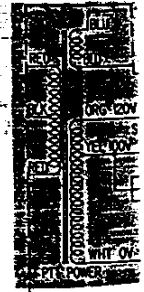

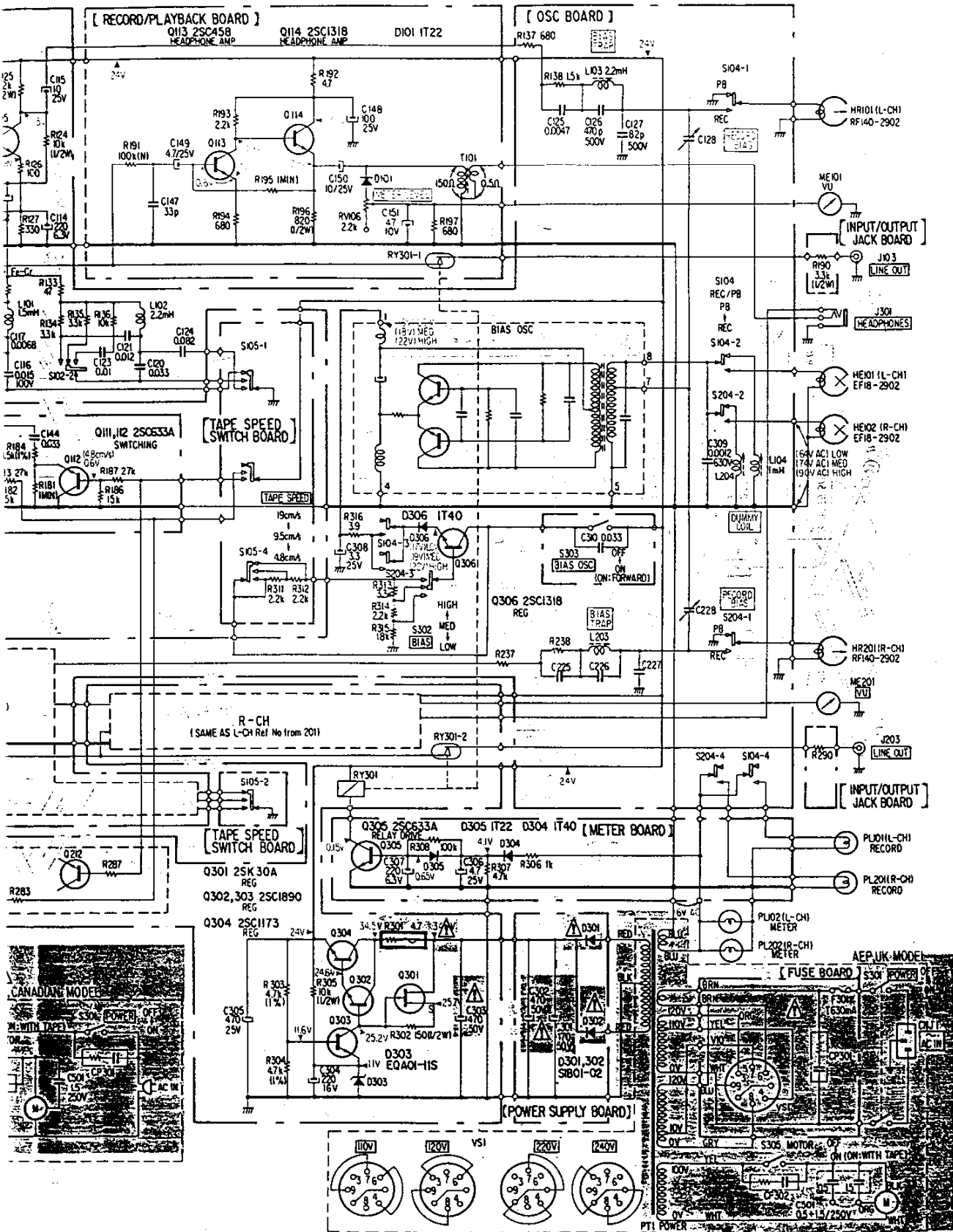

HR101 (L-CH)
RF140-2902

[INPUT/OUTPUT JACK BOARD]
J103
LINE OUT

J301
HEADPHONES

HE101 (L-CH)
EF18-2902

HE102 (R-CH)
EF18-2902

LOW
MED
HIGH

HR201 (R-CH)
RF140-2902

ME201
TUNING

J203
LINE OUT

[INPUT/OUTPUT JACK BOARD]

PL101 (L-CH)
RECORD

PL201 (R-CH)
RECORD

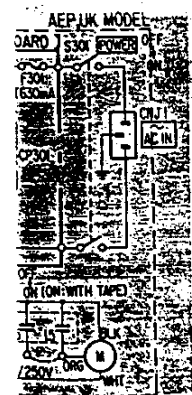

1
2
3
4
5

Note:

- Components for right channel have same values as for left channel. Reference numbers are coded from 201.
- All capacitors are in μF unless otherwise noted. $\text{pF} = \mu\mu\text{F}$ 50WV or less are not indicated except for electrolytics.
- All resistors are in ohms, $\frac{1}{2}\text{W}$ unless otherwise noted. $\text{k}\Omega = 1000\Omega$, $\text{M}\Omega = 1000\text{k}\Omega$
- : fusible and nonflammable resistor.
- (N) : low-noise resistor.
- 1% indicates component tolerance.
- : B+ bus.
- : panel designation.
- : adjustment for repair.
- : direct connection to points marked on the chassis.
- Voltages are dc with respect to ground unless otherwise noted.
- Readings are taken in stop mode with a VOM (20 $\text{k}\Omega/\text{V}$). () : record mode
- AC voltage readings in the bias oscillator circuit are taken with a VTVM.
- Transistor base-emitter voltages are measured on the 2.5V range.
- Voltage variations may be noted due to normal production tolerances.
- Switch

Ref. No.	Switch	Position
S101, 201	MIC ATT	0dB
S102, 202	EQ	SPECIAL
S103, 203	MONITOR	TAPE
S104, 204	REC/PB	PB
S105, 205	TAPE SPEED	19 cm/s (7 1/2 ips)
S301	POWER	OFF
S302	BIAS	MED
S303	BIAS OSC	OFF
S304	MUTING	OFF
S305	MOTOR	OFF

Note: The components identified by shading and mark are critical for safety. Replace only with part number specified.

Note: Les composants identifiés par un trame et une marque sont critiques pour la sécurité. Ne les remplacer que par une pièce portant le numéro spécifié.

FOR SERVICE MANUALS
CONTACT:
MAURITRON TECHNICAL SERVICES
www.mauritron.co.uk
TEL: 01844 - 351694
FAX: 01844 - 352554

SECTION 5
EXPLODED VIEWS

A B C D E

5-1.

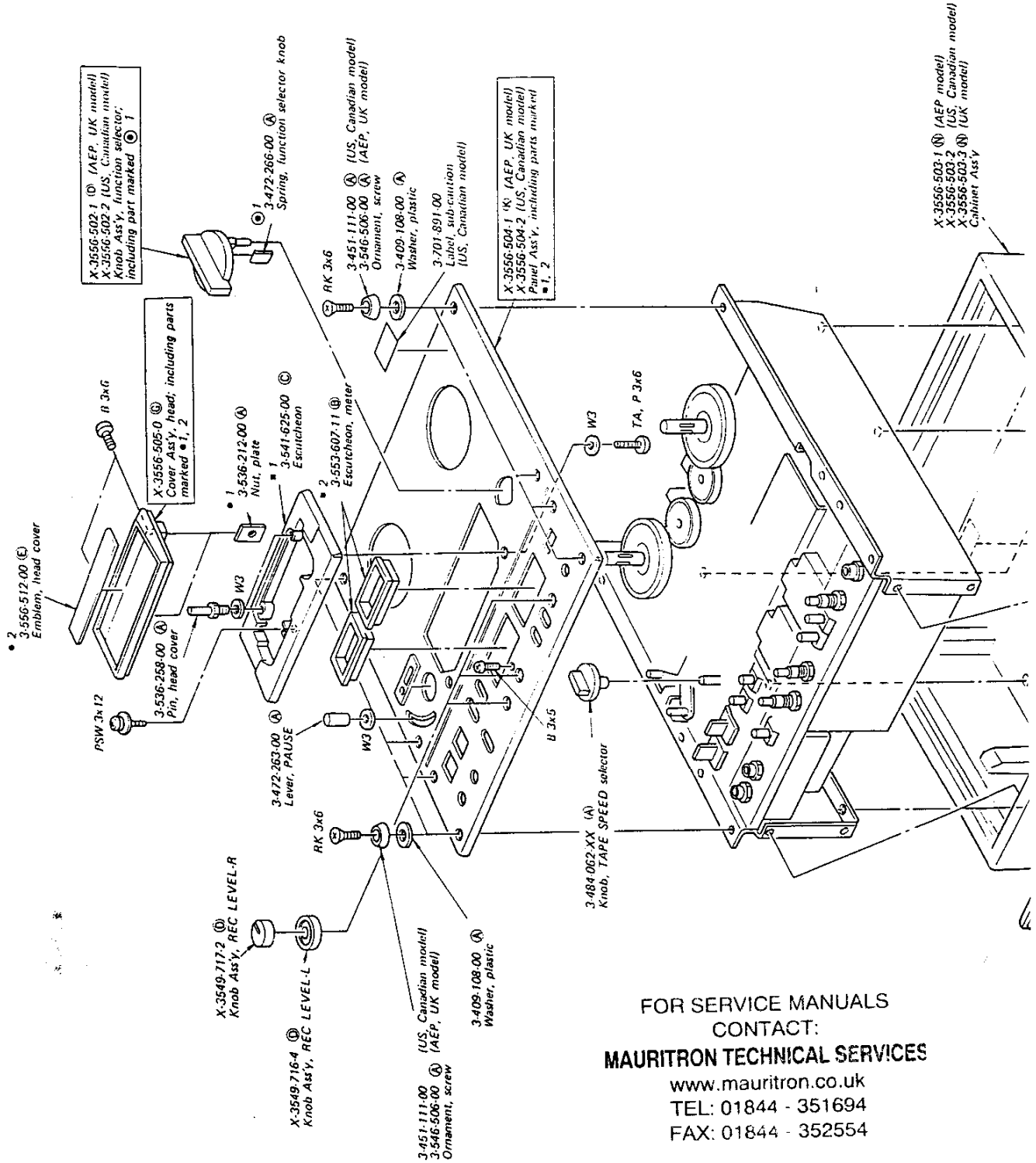

FOR SERVICE MANUALS
CONTACT:
MAURITRON TECHNICAL SERVICES
www.mauritron.co.uk
TEL: 01844 - 351694
FAX: 01844 - 352554

1 2 3 4

SECTION 5
EXPLODED VIEWS

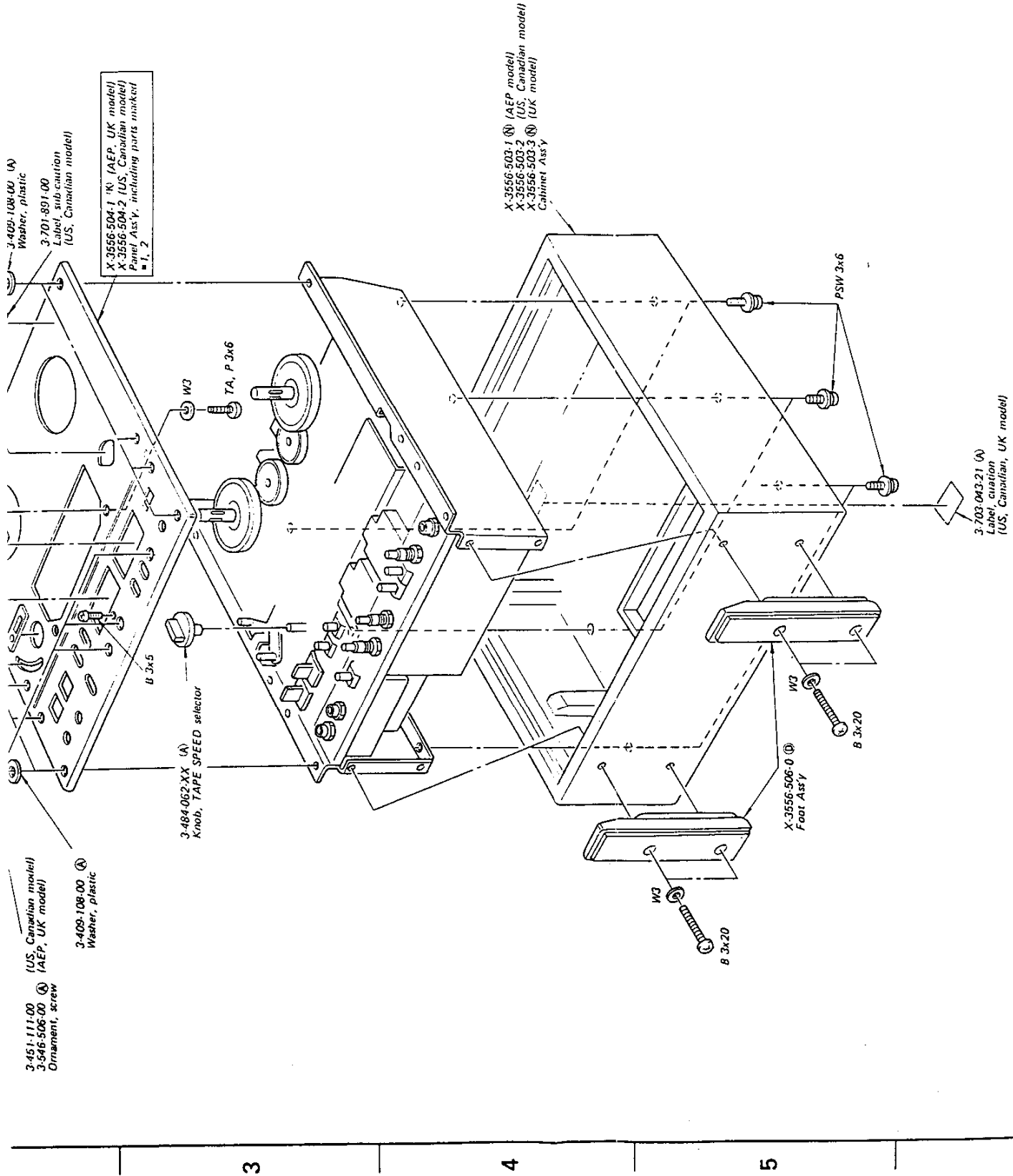

3

4

5

6

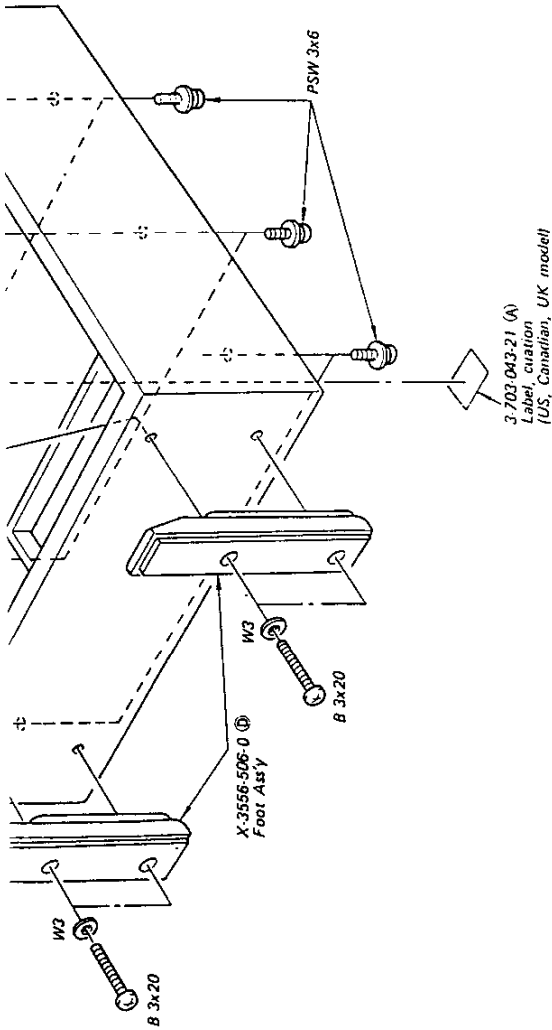

Note:

- Items with no part number and/or no description are not stocked because they are seldom required for routine service.
- All screws are Phillips (cross recess) type unless otherwise noted.
- (-) = slotted head
- Circled letters (A) to (Z) are applicable to European models only.

FOR SERVICE MANUALS
 CONTACT:
MAURITRON TECHNICAL SERVICES
 www.mauritron.co.uk
 TEL: 01844 - 351694
 FAX: 01844 - 352554

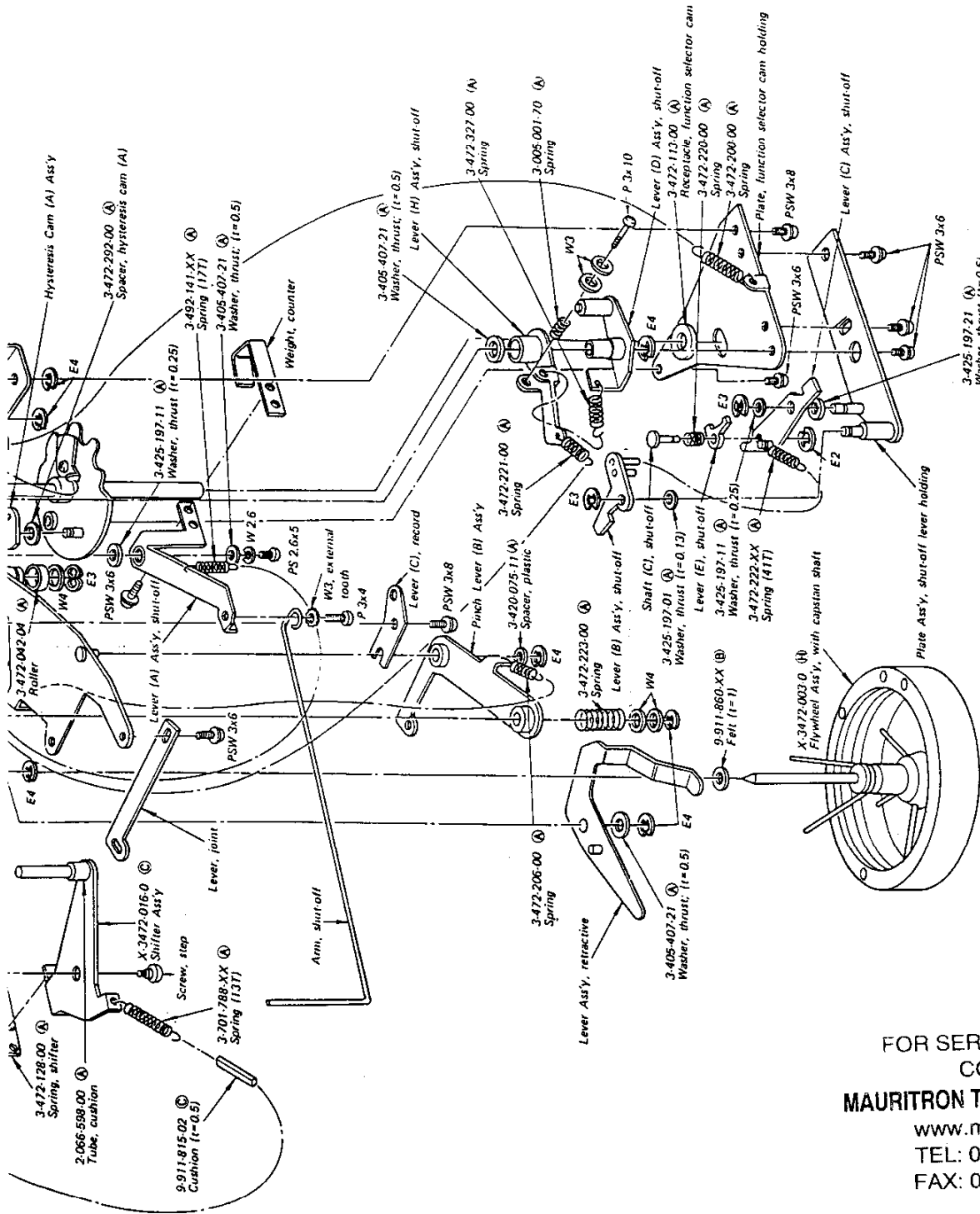

FOR SERVICE MANUALS
CONTACT:
MAURITRON TECHNICAL SERVICES
www.mauritron.co.uk
TEL: 01844 - 351694
FAX: 01844 - 352554

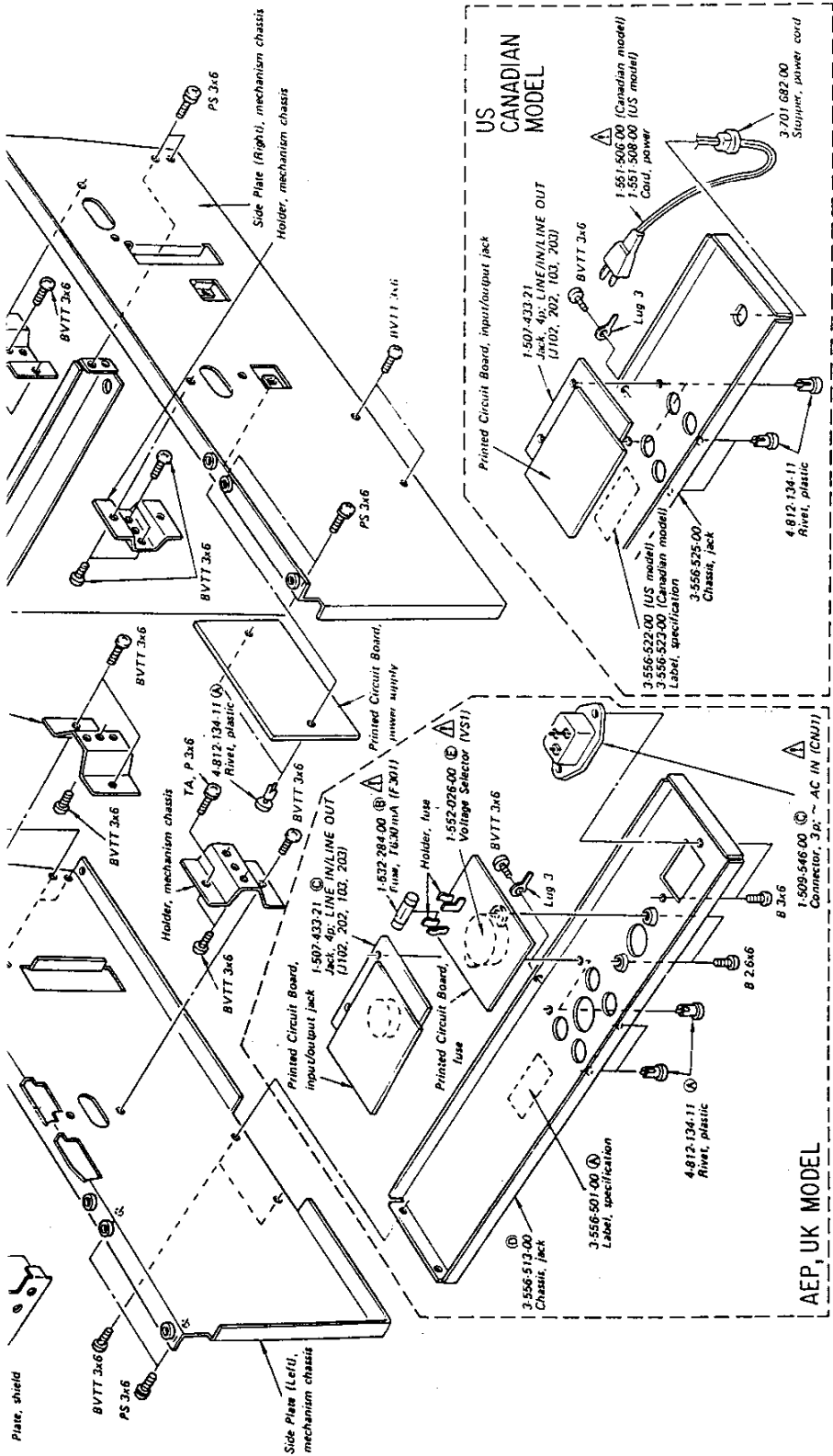

Note:

- Items with no part number and/or no description are not stocked because they are seldom required for routine service.
- All screws are Philips (cross recess) type unless otherwise noted.
- (—) = slotted head
- Circled letters (A) to (Z) are applicable to European models only.
- (TRIT) shows the number of coils in spring.

Note: The components identified by shading and Δ mark are critical for safety. Replace only with part number specified.

Note: Les composants identifiés par un trame et une marque Δ sont critiques pour la sécurité. Ne les remplacer que par une pièce portant le numéro spécifique.

FOR SERVICE MANUALS CONTACT:
MAURITRON TECHNICAL SERVICES
 www.mauritron.co.uk
 TEL: 01844 - 351694
 FAX: 01844 - 352554

A B C D E

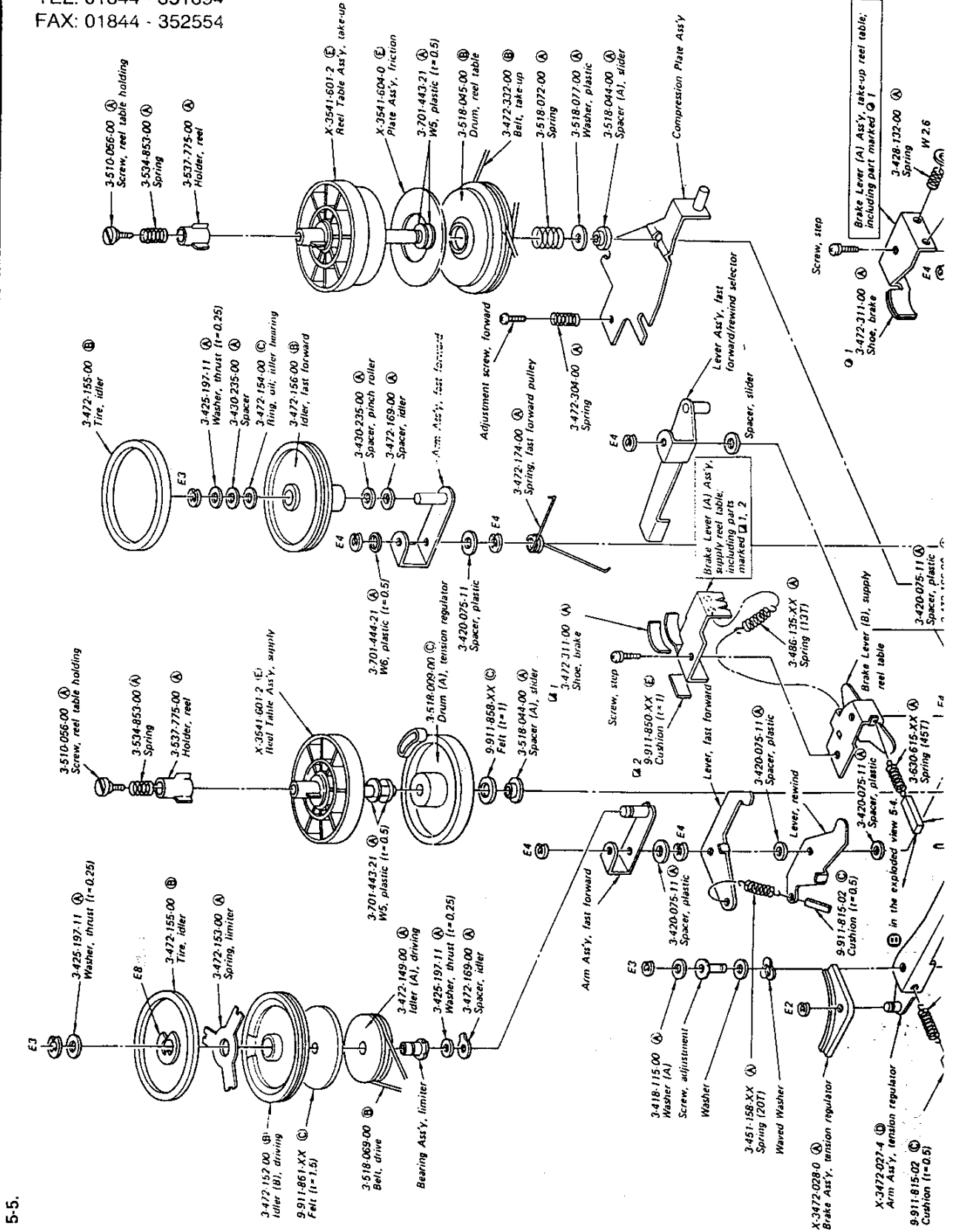

5-5.

1

2

3

4

41

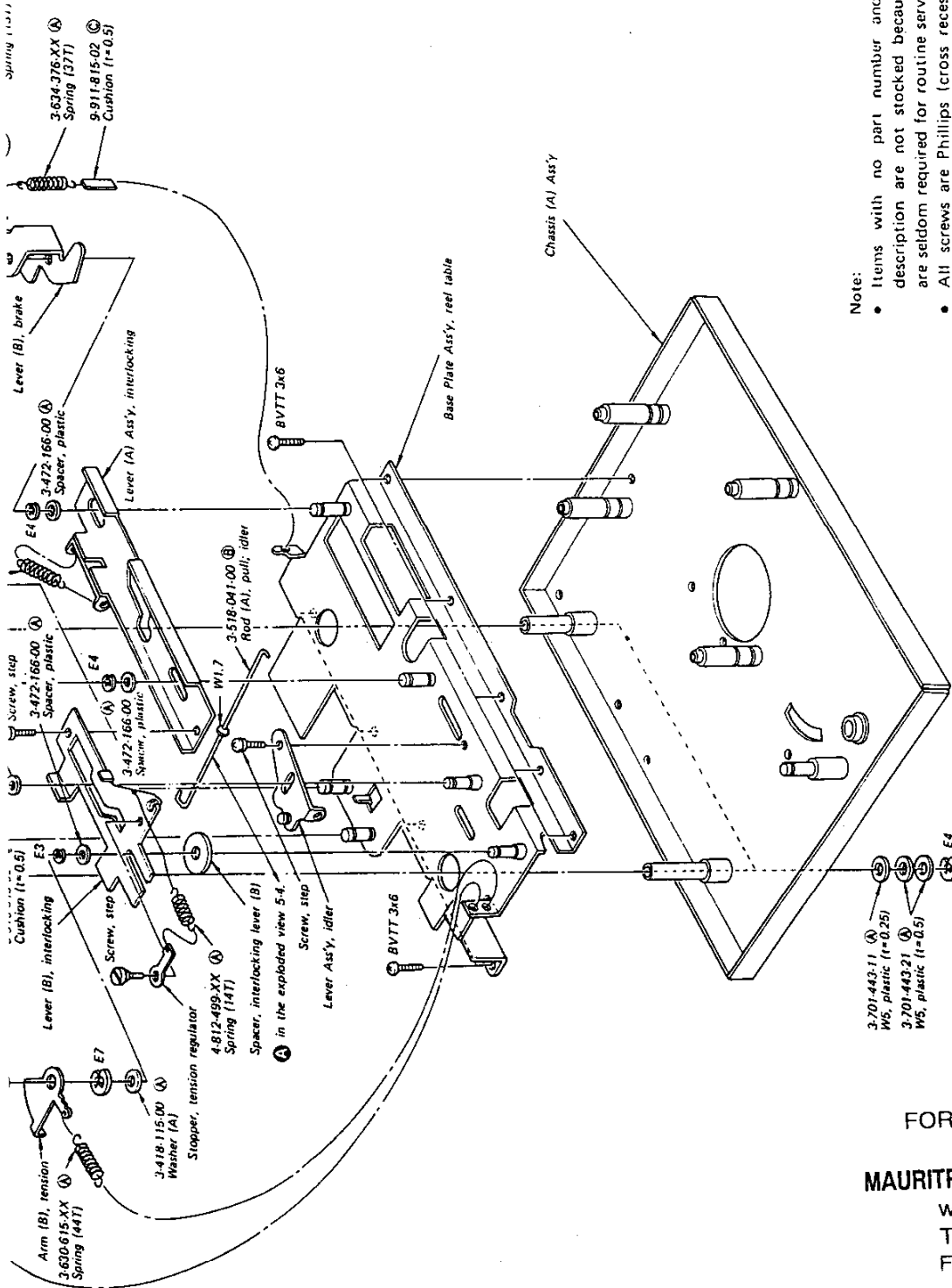

- Note:
- Items with no part number and/or no description are not stocked because they are seldom required for routine service.
 - All screws are Phillips (cross recess) type unless otherwise noted.
 - (-) = slotted head
 - Circled letters (A to Z) are applicable to European models only.
 - (E/T) shows the number of coils in spring.

FOR SERVICE MANUALS
CONTACT:
MAURITRON TECHNICAL SERVICES
www.mauritron.co.uk
TEL: 01844 - 351694
FAX: 01844 - 352554

SECTION 6 ELECTRICAL PARTS LIST

Note: Circled letters ((A) to (Z)) are applicable to European models only.

<u>Ref. No.</u>	<u>Part No.</u>	<u>Description</u>
SEMICONDUCTORS		
Transistors		
Q101,201 Q102,202 ⇒ Q103,203 ⇒ Q104,204 ⇒ Q105,205	8-729-334-58	(B) 2SC1345
Q106,206 Q107,207 ⇒ Q108,208 Q109,209 ⇒ Q110,210	8-729-334-58	(B) 2SC1345
⇒ Q111,211 ⇒ Q112,212 ⇒ Q113,213 ⇒ Q114,214	8-729-663-47	(B) 2SC1364
⇒ Q301 ⇒ Q302,303 Q304 ⇒ Q305 ⇒ Q306	8-729-203-04 8-729-334-58 8-729-217-33 8-729-663-47 8-760-413-10	(B) 2SK30 (B) 2SC1345 (C) 2SC1173 (B) 2SC1364 (C) 2SC1475
Diodes		
⇒ D101,201	8-719-422-21	(A) 1T22AM
⇒ D301,302	8-719-200-02	(B) 10E2
⇒ D303 ⇒ D304 ⇒ D305 ⇒ D306	8-719-111-07 8-719-815-55 8-719-422-21 8-719-815-55	(B) RD11E (B) 1S1555 (A) 1T22AM (B) 1S1555
COILS		
L101,201 L102,202 L103,203 L104,204	1-407-213-XX 1-407-198-XX 1-407-286-00 1-407-284-00	(A) 1.5 mH (A) 2.2 mH (B) 2.2 mH, adjustable (B) 1 mH, adjustable

⇒: Due to standardization, interchangeable replacements may be substituted for parts specified in the diagrams.

<u>Ref. No.</u>	<u>Part No.</u>	<u>Description</u>
TRANSFORMERS		
PT1	1-446-031-00 1-446-084-00	(C) Power (AEP, UK model) (C) Power (US, Canadian model)
T101,201	1-427-424-11	(C) Output

CAPACITORS					
All capacitors are in μF and ceramic unless otherwise noted. 50WV or less are not indicated except for electrolytics. $p = \mu\text{F}$, elect = electrolytic					
C101,201	1-131-196-11	(B) 2.2	20V	tantalum	
C102,202	1-121-404-11	(A) 33	25V	elect	
C103,203	1-102-074-11	(A) 0.001			
C104,204	1-121-413-11	(A) 100	6.3V	elect	
C105,205	1-121-392-11	(A) 3.3	25V	elect	
C106,206	1-131-230-11	(B) 6.8	10V	tantalum	
C107,207	1-121-404-11	(A) 33	25V	elect	
C108,208	1-102-975-11	(A) 100p			
C109,209	1-121-413-11	(A) 100	6.3V	elect	
C110,210	1-121-398-11	(A) 10	25V	elect	
C111,211	1-131-211-11	(B) 0.22	35V	tantalum	
C112,212	1-121-398-11	(A) 10	25V	elect	
C113,213	1-121-479-11	(A) 22	16V	elect	
C114,214	1-121-419-11	(A) 220	6.3V	elect	
C115,215	1-121-398-11	(A) 10	25V	elect	
C116,216	1-129-927-11	(B) 0.015	100V	polyethylene	
C117,217	1-108-575-12	(A) 0.0068		mylar	
C118,218	1-108-561-12	(A) 0.0018		mylar	
C119,219	1-108-573-12	(A) 0.0056		mylar	
C120,220	1-108-591-12	(A) 0.033		mylar	
C121,221	1-108-581-12	(A) 0.012		mylar	
C123,223	1-108-579-12	(A) 0.01		mylar	
C124,224	1-108-601-12	(B) 0.082		mylar	
C125,225	1-108-571-12	(A) 0.0047		mylar	
C126,226	1-107-185-11	(A) 470p	500V	mica	
C127,227	1-107-037-11	(A) 82p	500V	mica	
C128,228	1-141-010-XX	(B)		trimmer	

Note: The components identified by shading and Δ mark are critical for safety. Replace only with part number specified.

Note: Les composants identifiés par un trame et une marque Δ sont critiques pour la sécurité. Ne les remplacer que par une pièce portant le numéro spécifié.

Note: Circled letters ((A) to (Z)) are applicable to European models only.

Ref. No.	Part No.	Description
C131,231	1-131-195-11 (B) 33	10V elect
C132,232	1-121-404-11 (A) 33	25V elect
C133,233	1-102-975-11 (A) 100p	
C134,234	1-121-419-11 (A) 220	6.3V elect
C135,235	1-121-420-11 (A) 220	10V elect
C136,236	1-129-927-11 (B) 0.015	100V polyethylene
C137,237	1-121-398-11 (A) 10	25V elect
C138,238	1-129-896-11 (A) 0.012	100V polyethylene
C139,239	1-102-113-11 (A) 390p	
C140,240	1-102-117-11 (A) 820p	
C141,241	1-131-230-11 (B) 6.3	10V tantalum
C142,242	1-121-404-11 (A) 33	25V elect
C143,243	1-108-587-12 (A) 0.022	mylar
C144,244	1-108-591-12 (A) 0.033	mylar
C145,245	1-121-413-11 (A) 100	6.3V elect
C146,246	1-121-398-11 (A) 10	25V elect
C147,247	1-102-969-11 (C) 33p	
C148,248	1-121-416-11 (A) 100	25V elect
C149,249	1-121-395-11 (A) 4.7	25V elect
C150,250	1-121-398-11 (A) 10	25V elect
C151,251	1-121-352-11 (A) 47	10V elect
C301-303	(A) 1-121-810-11 (B) 470	50V elect
C304	1-121-421-11 (B) 220	16V elect
C305	1-121-733-11 (B) 470	25V elect
C306	1-121-961-11 (A) 4.7	25V elect
C307	1-121-981-11 (B) 220	6.3V elect
C308	1-121-392-11 (A) 3.3	25V elect
C309	1-129-703-11 (B) 0.0012	630V polyethylene
C310	1-108-244-12 (A) 0.033	mylar
C501	(A) 1-117-034-23 1.5 250V paper (US, Canadian model)	
C501	(A) 1-117-036-22 (C) 1.5+0.5 250V paper (AEP, UK model)	

FOR SERVICE MANUALS
CONTACT:
MAURITRON TECHNICAL SERVICES
www.mauritron.co.uk
TEL: 01844 - 351694
FAX: 01844 - 352554

Note: The components identified by shading and (A) mark are critical for safety. Replace only with part number specified.

Ref. No. Part No. Description

RESISTORS

All resistors are in ohms. Common 1/4W carbon resistors are omitted.

Refer to the list on the last page for their part numbers.

All variable and adjustable resistors have characteristic curve B, unless otherwise noted.

R110,210	1-244-923-11 (A) 120 k	1/2W carbon
R113,213	1-244-865-11 (A) 470	1/2W carbon
R115,215	1-244-911-11 (A) 39 k	1/2W carbon
R116,216	1-244-887-11 (A) 3.9 k	1/2W carbon
R122,222	1-244-873-11 (A) 1 k	1/2W carbon
R124,224	1-244-897-11 (A) 10 k	1/2W carbon
R125,225	1-244-875-11 (A) 1.2 k	1/2W carbon
R153,253	1-244-912-11 (A) 43 k	1/2W carbon
R157,257	1-244-893-11 (A) 6.8 k	1/2W carbon
R158,258	1-244-927-11 (A) 180 k	1/2W carbon
R159,259	1-244-855-11 (A) 180	1/2W carbon
R160,260	1-244-889-11 (A) 4.7 k	1/2W carbon
R163,263	1-214-144-11 (A) 3.3 k	1/4W metal oxide (1%)
R172,272	1-244-873-11 (A) 1 k	1/2W carbon
R174,274	1-244-875-11 (A) 1.2 k	1/2W carbon
R175,275	1-244-907-11 (A) 27 k	1/2W carbon
R176,276	1-244-881-11 (A) 2.2 k	1/2W carbon
R180,280	1-214-142-11 (A) 2.7 k	1/4W metal oxide (1%)
R184,284	1-214-136-11 (A) 1.5 k	1/4W metal oxide (1%)
R190,290	1-244-885-11 (A) 3.3 k	1/2W carbon
R196,296	1-244-871-11 (A) 820	1/2W carbon
R301	(A) 1-217-383-11 (B) 4.7	1/4W fusible (nonflammable)
R302	1-244-853-11 (A) 150	1/2W carbon
R303,304	1-214-148-11 (A) 4.7 k	1/4W metal oxide (1%)
R305	1-244-897-11 (A) 10 k	1/2W carbon
RV101,201	1-226-223-00 (E) 20 k (A), variable; MIC	
RV102,202	1-226-224-00 (E) 50 k (A), variable; LINE	
RV103,203	1-224-646-XX (B) 22 k, adjustable; RECORD LEVEL	
RV104,204	1-224-646-XX (B) 22 k, adjustable; PLAYBACK LEVEL	
RV105,205	1-226-225-00 (B) 10 k, variable; PB LEVEL	
RV106,206	1-224-643-XX (B) 2.2 k, adjustable; METER LEVEL	

Note: Les composants identifiés par un trame et une marque (A) sont critiques pour la sécurité. Ne les remplacer que par une pièce portant le numéro spécifié.

Note: Circled letters (A to Z) are applicable to European models only.

Ref. No. Part No. Description

SWITCHES

S101,201 1-552-391-00 (C) Lever Slide, MIC ATT
 S102,202 1-552-394-00 (C) Lever Slide, EQ
 S103,203 1-552-392-00 (C) Lever Slide, MONITOR
 S104,204 1-516-367-XX (C) Push, REC/PB
 S105 1-552-395-00 (D) Rotary, TAPE SPEED

S301 **A** 1-552-018-00 (C) Pushbutton, POWER (US, Canadian model)
 S301 **A** 1-552-206-11 (D) Pushbutton, POWER (AEP, UK model)
 S302 1-552-393-00 (C) Lever Slide, BIAS
 S303 1-514-864-XX (D) Miniature, BIAS OSC
 S304 1-514-643-00 (B) Rotary, MUTING
 S305 **A** 1-514-039-12 (C) Miniature, MOTOR

MISCELLANEOUS

CNJ1 **A** 1-509-546-00 (C) Connector, 3p; ~ AC IN (AEP, UK model)
 CNJ2 1-509-549-00 (B) Connector, REC/PB (AEP, UK model)
 CP301 **A** 1-231-057-31 (B) Encapsulated Component (AEP, UK model)
 CP301,302 **A** 1-231-325-11 Encapsulated Component (US model)
 CP301,302 **A** 1-231-345-11 Encapsulated Component (Canadian model)
 CP302 **A** 1-231-325-11 (C) Encapsulated Component (AEP, UK model)
 F301 **A** 1-532-284-00 (B) Fuse, T630 mA (AEP, UK model)
 HE101,201 8-825-698-00 (E) Head, erase; EF18-2902
 HP101,201 8-825-534-10 (L) Head, playback; PF140-4202B
 HR101,201 8-825-511-10 (K) Head, record; RF140-2902
 J101,201 1-507-587-21 (C) Jack, MIC
 J102,202 1-507-433-21 (N) Jack, 4p; LINE IN/LINE OUT
 J103,203
 J301 1-507-553-21 (N) Jack, HEADPHONES
 M **A** 8-832-624-56 (M) Motor, IC624H1 (US, AEP, UK model)

Ref. No. Part No. Description

M **A** 8-832-627-00 Motor, IC624H1 (Canadian model)
 ME101,201 1-520-337-00 (J) Meter, VU
 PL101,201 1-518-115-XX (B) Lamp, 6 V 35 mA
 RY301 1-515-294-00 (F) Relay
 VS1 **A** 1-552-026-00 (E) Voltage Selector (AEP, UK model)
 1-464-029-00 (G) OSC Pack
A 1-551-506-00 Cord, power (Canadian model)
A 1-551-508-00 Cord, power (US model)

ACCESSORIES & PACKING MATERIALS

Part No. Description

X-2440-055-1 (K) Reel Ass'y, R-7MB (UK model)
 X-2440-069-0 Reel Ass'y, R-7ES (US, Canadian model)
 X-2440-073-0 (K) Reel Ass'y, R-7MB (AEP model)
 X-3701-105-0 (A) Cleaning Tip Ass'y (Canadian, AEP, UK model)
 1-534-049-31 (E) Cord, connection; RK-74
 1-534-819-12 (G) Cord, power (UK model)
 3-401-193-00 Tape (US model)
 3-556-528-00 (G) Carton (AEP, UK, Canadian model)
 3-556-529-00 (B) Spacer
 3-556-530-00 (C) Cushion, right
 3-556-531-00 (C) Cushion, left
 3-556-532-00 (B) Cushion, bottom
 3-556-534-00 Carton (US model)
 3-701-630-00 (A) Bag, plastic
 3-701-684-11 (B) Card, power voltage indication (AEP, UK model)
 3-770-504-11 (E) Manual, instruction (AEP, UK model)
 3-770-504-21 Manual, instruction (US model)
 3-770-504-21 Manual, instruction (Canadian model)
 3-794-247-31
 4-848-648-00 (B) Bag, protection

Note: The components identified by shading and **A** mark are critical for safety. Replace only with part number specified.

Note: Les composants identifiés par un trame et une marque **A** sont critiques pour la sécurité. Ne les remplacer que par une pièce portant le numéro spécifié.

1/4 WATT CARBON RESISTORS (A)

Note: Circled letter (A) is applicable to European model only.

Ω	Part No.	Ω	Part No.	Ω	Part No.	Ω	Part No.	Ω	Part No.	Ω	Part No.	Ω	Part No.
1.0	1-244-601-11	10	1-244-625-11	100	1-244-649-11	1.0k	1-244-673-11	10k	1-244-697-11	100k	1-244-721-11	1.0M	1-244-745-11
1.1	1-244-602-11	11	1-244-626-11	110	1-244-650-11	1.1k	1-244-674-11	11k	1-244-698-11	110k	1-244-722-11	1.1M	1-244-746-11
1.2	1-244-603-11	12	1-244-627-11	120	1-244-651-11	1.2k	1-244-675-11	12k	1-244-699-11	120k	1-244-723-11	1.2M	1-244-747-11
1.3	1-244-604-11	13	1-244-628-11	130	1-244-652-11	1.3k	1-244-676-11	13k	1-244-700-11	130k	1-244-724-11	1.3M	1-244-748-11
1.5	1-244-605-11	15	1-244-629-11	150	1-244-653-11	1.5k	1-244-677-11	15k	1-244-701-11	150k	1-244-725-11	1.5M	1-244-749-11
1.6	1-244-606-11	16	1-244-630-11	160	1-244-654-11	1.6k	1-244-678-11	16k	1-244-702-11	160k	1-244-726-11	1.6M	1-244-750-11
1.8	1-244-607-11	18	1-244-631-11	180	1-244-655-11	1.8k	1-244-679-11	18k	1-244-703-11	180k	1-244-727-11	1.8M	1-244-751-11
2.0	1-244-608-11	20	1-244-632-11	200	1-244-656-11	2.0k	1-244-680-11	20k	1-244-704-11	200k	1-244-728-11	2.0M	1-244-752-11
2.2	1-244-609-11	22	1-244-633-11	220	1-244-657-11	2.2k	1-244-681-11	22k	1-244-705-11	220k	1-244-729-11	2.2M	1-244-753-11
2.4	1-244-610-11	24	1-244-634-11	240	1-244-658-11	2.4k	1-244-682-11	24k	1-244-706-11	240k	1-244-730-11	2.4M	1-244-754-11
2.7	1-244-611-11	27	1-244-635-11	270	1-244-659-11	2.7k	1-244-683-11	27k	1-244-707-11	270k	1-244-731-11	2.7M	1-244-755-11
3.0	1-244-612-11	30	1-244-636-11	300	1-244-660-11	3.0k	1-244-684-11	30k	1-244-708-11	300k	1-244-732-11	3.0M	1-244-756-11
3.3	1-244-613-11	33	1-244-637-11	330	1-244-661-11	3.3k	1-244-685-11	33k	1-244-709-11	330k	1-244-733-11	3.3M	1-244-757-11
3.6	1-244-614-11	36	1-244-638-11	360	1-244-662-11	3.6k	1-244-686-11	36k	1-244-710-11	360k	1-244-734-11	3.6M	1-244-758-11
3.9	1-244-615-11	39	1-244-639-11	390	1-244-663-11	3.9k	1-244-687-11	39k	1-244-711-11	390k	1-244-735-11	3.9M	1-244-759-11
4.3	1-244-616-11	43	1-244-640-11	430	1-244-664-11	4.3k	1-244-688-11	43k	1-244-712-11	430k	1-244-736-11	4.3M	1-244-760-11
4.7	1-244-617-11	47	1-244-641-11	470	1-244-665-11	4.7k	1-244-689-11	47k	1-244-713-11	470k	1-244-737-11	4.7M	1-244-761-11
5.1	1-244-618-11	51	1-244-642-11	510	1-244-666-11	5.1k	1-244-690-11	51k	1-244-714-11	510k	1-244-738-11	5.1M	1-244-762-11
5.6	1-244-619-11	56	1-244-643-11	560	1-244-667-11	5.6k	1-244-691-11	56k	1-244-715-11	560k	1-244-739-11		
6.2	1-244-620-11	62	1-244-644-11	620	1-244-668-11	6.2k	1-244-692-11	62k	1-244-716-11	620k	1-244-740-11		
6.8	1-244-621-11	68	1-244-645-11	680	1-244-669-11	6.8k	1-244-693-11	68k	1-244-717-11	680k	1-244-741-11		
7.5	1-244-622-11	75	1-244-646-11	750	1-244-670-11	7.5k	1-244-694-11	75k	1-244-718-11	750k	1-244-742-11		
8.2	1-244-623-11	82	1-244-647-11	820	1-244-671-11	8.2k	1-244-695-11	82k	1-244-719-11	820k	1-244-743-11		
9.1	1-244-624-11	91	1-244-648-11	910	1-244-672-11	9.1k	1-244-696-11	91k	1-244-720-11	910k	1-244-744-11		





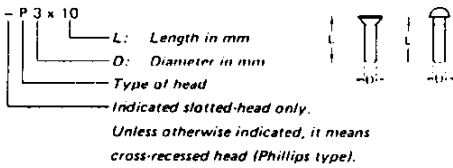



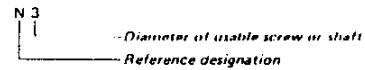



HARDWARE NOMENCLATURE













Screw:



Nut, Washer, Retaining ring:



Reference Designation	Shape	Description	Remarks
SCREWS			
P		pan-head screw	binding-head (B) screw for replacement
PWH		pan-head screw with washer face	binding-head (B) screw and flat washer for replacement
PS PSP		pan-head screw with spring washer	binding-head (B) screw and spring washer for replacement
PSW PSPW		pan-head screw with spring and flat washers	binding-head (B) screw and spring and flat washers for replacement
R		round-head screw	binding-head (B) screw for replacement
K		flat-countersunk-head screw	
RK		oval-countersunk-head screw	
II		binding-head screw	
T		truss-head screw	binding-head (B) screw for replacement
F		flat-fillister-head screw	
RF		fillister-head screw	
BV		brazer-head screw	

Reference Designation	Shape	Description	Remarks
SELF-TAPPING SCREWS			
TA		self-tapping screw	ex: TA, P 3 x 10
PTP		pan-head self-tapping screw	binding-head self-tapping (TA, B) screw for replacement
PTPWH		pan-head self-tapping screw with washer face	binding-head self-tapping (TA, B) screw and flat washer for replacement
PTTWH		pan-head thread-rolling screw with washer face	binding-head (B) screw and flat washer for replacement
SET SCREWS			
SC		set screw	
SC		hexagon-socket set screw	ex: SC 2.6 x 4, hexagon socket
NUT			
N		nut	
WASHERS			
W		flat washer	
SW		spring washer	
IW		internal tooth lock washer	ex: LWJ, internal
LW		external-tooth lock washer	ex: LWJ, external
RETAINING RINGS			
E		retaining ring	
G		grip-type retaining ring	

Sony Corporation

© 1978

- 46 -

TC-399

US Model
Canadian Model
AEP Model
UK Model

No. 1
December, 1978

SUPPLEMENT

Subject: Circuit Modification

This supplement updates the service manual to include production changes.
File this supplement the service manual.

1. ADDITIONAL PART

<u>Ref. No.</u>	<u>Part No.</u>	<u>Description</u>
C311	1-102-074-21	Capacitor, ceramic 0.001 μ F

FOR SERVICE MANUALS
CONTACT:
MAURITRON TECHNICAL SERVICES

www.mauritron.co.uk

TEL: 01844 - 351694

FAX: 01844 - 352554

SONY
SERVICE MANUAL

