

AKAI SERVICE MANUAL

**STEREO TAPE DECK
4000DS
4000DS Mk-II**

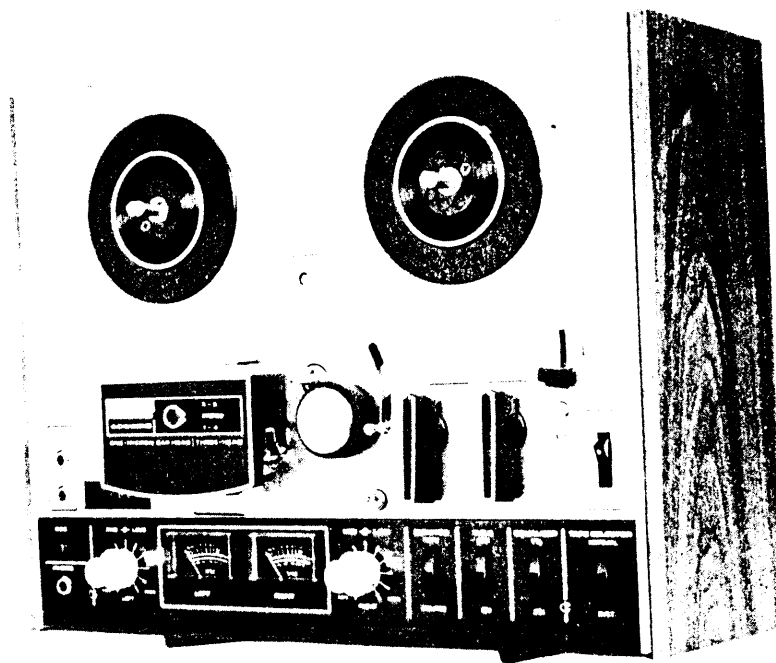

STEREO TAPE DECK

MODEL 4000DS

SECTION 1	SERVICE MANUAL	2
SECTION 2	PARTS LIST	17
SECTION 3	SCHEMATIC DIAGRAM	36

For Service Manuals
MAURITRON SERVICES
8 Cherry Tree Road, Chinnor
Oxfordshire, OX9 4QY.
Tel (01844) 351694
Fax (01844) 352554
email:- mauritron@dial.pipex.com

SECTION 1
SERVICE MANUAL

TABLE OF CONTENTS

I.	SPECIFICATIONS	3
II.	MEASURING METHOD	4
III.	DISMANTLING OF TAPE TRANSPORT UNIT & AMPLIFIERS	6
IV.	MECHANISM ADJUSTMENTS	8
V.	HEAD ADJUSTMENTS	11
VI.	AMPLIFIER ADJUSTMENTS	12
VII.	COMPOSITE VIEWS OF COMPONENTS	14

I. SPECIFICATIONS

An asterisk next to a figure indicates the minimum guaranteed performance.

TRACK SYSTEM	4-track 2-channel stereo/monaural system	
REEL CAPACITY	Up to 7" reel	
TAPE SPEED	7-1/2 and 3-3/4 ips $\pm 2\%$ (* $\pm 3\%$)	
WOW AND FLUTTER	Less than 0.15% (*0.22%) RMS at 7-1/2 ips Less than 0.20% (*0.30%) RMS at 3-3/4 ips	
FREQUENCY RESPONSE	AKAI SRT tape	30 to 23,000 Hz (*40 to 22,000 Hz) ± 3 dB at 7-1/2 ips 30 to 16,000 Hz (*40 to 14,000 Hz) ± 3 dB at 3-3/4 ips
	Regular tape	30 to 20,000 Hz (*40 to 20,000 Hz) ± 3 dB at 7-1/2 ips 30 to 14,000 Hz (*40 to 14,000 Hz) ± 3 dB at 3-3/4 ips
SIGNAL TO NOISE RATIO	Better than 50 dB at 7-1/2 ips Better than 48 dB at 3-3/4 ips	
DISTORTION	Less than 1.5% (*2.0%) at 7-1/2 ips Less than 2.5% at 3-3/4 ips	
CROSS TALK	Better than 70 dB (*60 dB) monaural Better than 50 dB (*45 dB) stereo	
ERASE RATIO	Better than 70 dB	
INPUTS	Mic input Line input Din input	0.8 mV Impedance 5 k Ω 70 mV Impedance 150 k Ω 7 mV
OUTPUTS	Line output Din output	1.228V (4 \pm 1 dB) using a 250 Hz "0" VU recorded tape 0.4V
BIAS FREQUENCY	105 kHz $\pm 5\%$	
BIAS LEAK	Less than -30 VU	
HIGH FREQUENCY DEVIATION	Within 2 dB using an 8,000 Hz 3-3/4 ips recorded tape at 7-1/2 ips	
RECORDING CAPACITY	60 min. stereo recording using a 1,200 ft. tape at 7-1/2 ips	
FAST FORWARD AND REWIND TIME	152/190 sec. using a 1,200 ft. tape at 60/50 Hz	
MOTOR	4-pole induction 1-speed motor Type: SSM-1 Revolutions: 1,800/1,500 rpm. at 60/50 Hz	
HEADS	Recording Head	In-line 4-track 2-channel recording head Type: P4-154 Gap: 1 micron Impedance: 95 Ω $\pm 15\%$ at 1,000 Hz
	Playback Head	In-line 4-track 2-channel playback head Type: P4-150 Gap: 1 micron Impedance: 1,250 Ω $\pm 15\%$ at 1,000 Hz
	Erase Head	In-line 4-track 2-channel erase head Type: E4-200 Gap: 0.6 mm Impedance: 200 Ω $\pm 5\%$ at 100 kHz
TRANSISTORS	6 2SC458 LG (C) (D) 2 2SC871 (E) (F)	
IC	4 LD3141	
DIODES	2 1N34A 1 10DC-1 1 1S339A	
POWER SUPPLY	100 to 240V A.C., 50/60 Hz 120V A.C., 60 Hz for CSA/UL Models 220V A.C., 50 Hz for CEE model	
POWER CONSUMPTION	35W	
INSULATION RESISTANCE	More than 50 M Ω	
INSULATION DURABILITY	1,000V A.C. for more than 1 min. duration	
DIMENSIONS	406 (W) X 314 (H) X 194 (D) mm (15.9" X 12.4" X 7.6")	
WEIGHT	11.4 kg (25 lbs.)	

NOTE: Specifications subject to change without notice.

II. MEASURING METHOD

1. TAPE SPEED DEVIATION

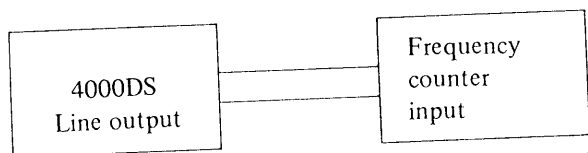

Fig. 1

As shown in Figure 1, connect a Frequency Counter to the Line Output of Model 4000DS. Take a frequency counter reading at the beginning, middle, and end of tape winding during playback. The maximum value of these respective readings will represent tape speed deviation.

2. WOW AND FLUTTER

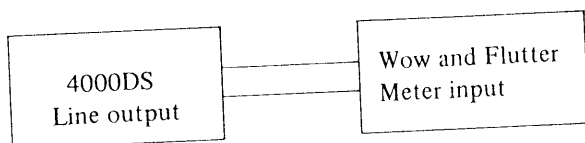

Fig. 2

Method A

As shown in Fig. 2, connect the Line Output of Model 4000DS to the Input of a Wow and Flutter Meter. Use a 3,000 Hz pre-recorded test tape and take a wow and flutter meter reading at the beginning, middle, and end of tape winding. The maximum value of these respective readings will represent the wow and flutter.

Method B

Supply a 3,000 Hz sine wave signal from an Audio Frequency Oscillator and make a recording on a blank tape at the beginning, middle, and end of tape winding. Rewind and playback tape. Measure wow and flutter with a Wow and Flutter Meter. (The wow and flutter value of Method B will be close to twice that of Method A.)

3. FREQUENCY RESPONSE

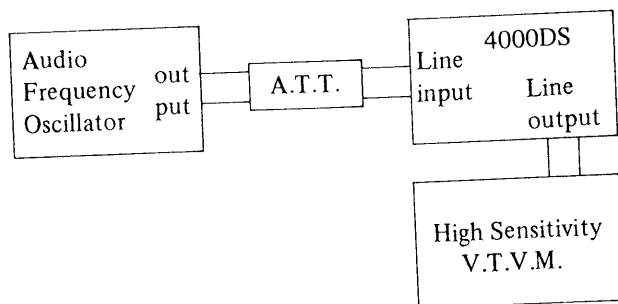

Fig. 3

For measuring frequency response, connect instruments as shown in Fig. 3 and proceed as follows:

- 1) Supply a 1,000 Hz sine wave to the Line Input of Model 4000DS from an Audio Frequency Oscillator through an Attenuator. Set recorder to recording mode and turn recording level volume control to maximum. Adjust Attenuator to obtain a +4 dB V.T.V.M. reading.
- 2) Under conditions described in 1) above, re-adjust Attenuator so that the Line Output is -16 dB, and record 40 to 20,000 Hz spot frequencies.
- 3) Rewind tape and playback from the beginning. Take V.T.V.M. spot frequency readings and plot values on a graph.

NOTE: When measuring frequency response, new tape should be used.

4. SIGNAL TO NOISE RATIO

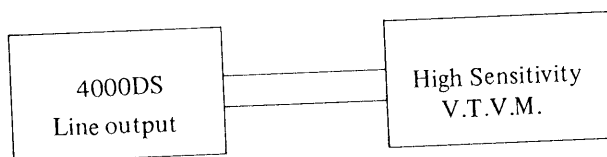

Fig. 4

As shown in Fig. 4, connect a High Sensitivity V.T.V.M. to the Line output of Model 4000DS. Playback a 250 Hz "O" VU pre-recorded test tape and measure the output. Then remove the tape and measure the noise level under the same condition. Convert each of the measured values into decibels.

5. TOTAL HARMONIC DISTORTION FACTOR

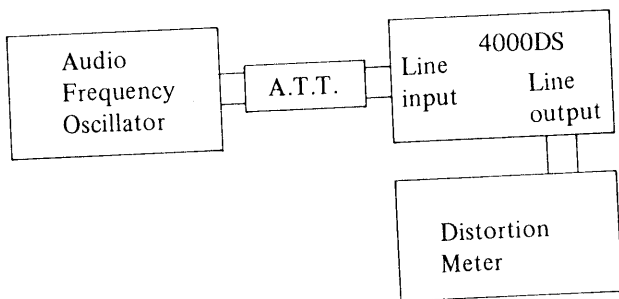

Fig. 5

Connect the measuring instruments as shown in Fig. 5 and record a 1,000 Hz sine wave signal at "0" VU. Playback the resultant signal and measure the overall distortion factor. Measure the noise level of the tape recorder without the tape. Connect the Audio Frequency Oscillator directly to the distortion meter for measurement of the distortion factor of the oscillator. The required distortion factor can be obtained from the results of the above measurement by the following formula:

$$d_0 = d - d_1 - d_2$$

where, d_0 – Required distortion factor
 d – Overall distortion factor
 d_1 – Noise level
 d_2 – Distortion factor of the oscillator

NOTE: When measuring the distortion factor, new tape should be used.

6. CROSS TALK (Cross talk between the tracks)

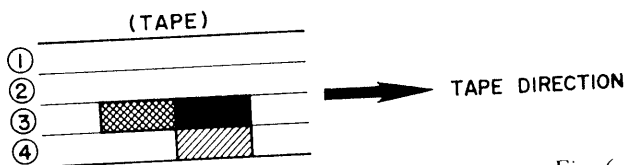

Fig. 6

As shown in Fig. 6, first record a 1,000 Hz sine wave signal on Track No. 3 at +3 VU level. Next, record under a non-input condition. Then, playback the tape on Tracks No. 3 and 4 through the B.P.F. (band pass filter sensitivity ... 1:1) and obtain a ratio between the two from the following formula:

$$C = 20 \log \frac{E_0}{E_2 - E_1} \text{ (dB)}$$

where, C – Desired cross talk ratio (dB)
 E_0 – 1,000 Hz signal output level
 E_2 – 1,000 Hz cross talk level
 E_1 – Non-input signal recorded level



7. ERASE RATIO

As shown in Fig. 4, connect a High Sensitivity V.T.V.M. to the Line Output of Model 4000DS. Playback a virgin tape and take a V.T.V.M. reading of the output level. Next, record a 1,000 Hz sine wave signal at +3 dB, then playback this recorded signal and take a V.T.V.M. reading of the output level. Next, using this pre-recorded tape, record under a non-input condition and take a reading of the noise level output of the erased signal and obtain a ratio between the two from the following formula:

$$Er = 20 \log \frac{E_0}{E_2 - E_1} \text{ (dB)}$$

Where, Er – Desired erase ratio (dB)
 E_0 – 1,000 Hz signal output level
 E_2 – Non-input signal recorded level
 E_1 – Virgin tape noise output level

For Service Manuals
MAURITRON SERVICES
 8 Cherry Tree Road, Chinnor
 Oxfordshire, OX9 4QY.
 Tel (01844) 351694
 Fax (01844) 352554
 email:- mauritron@dial.pipex.com

III. DISMANTLING OF TAPE TRANSPORT UNIT & AMPLIFIERS

In case of trouble, etc. necessitating disassembly, please disassemble in the order shown in photographs. Re-assemble in reverse order.

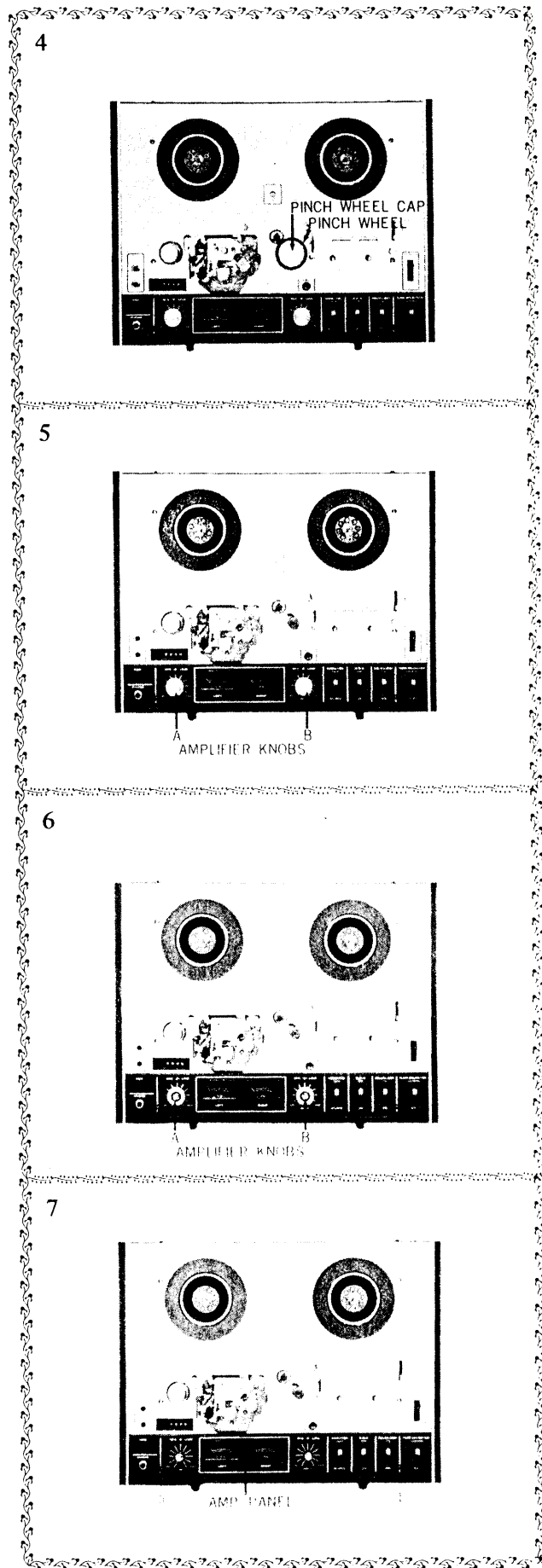
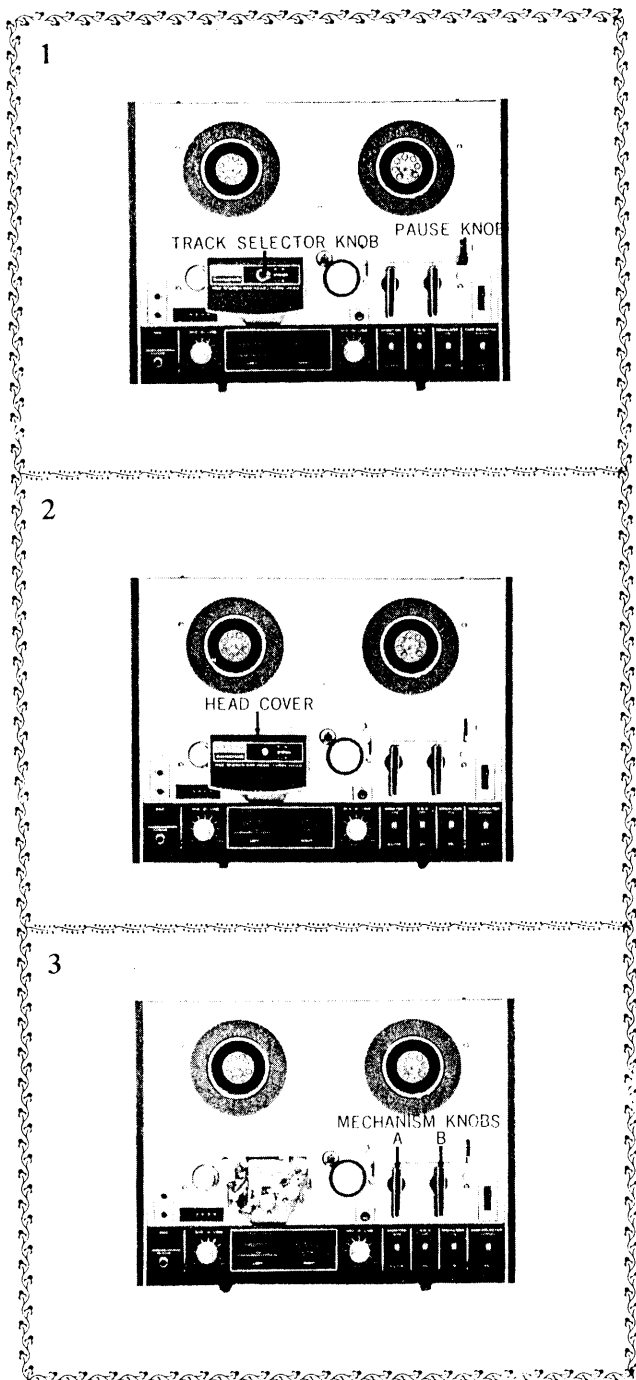

8

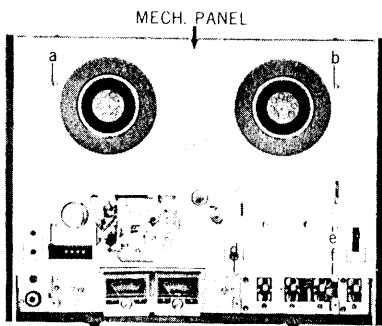

12

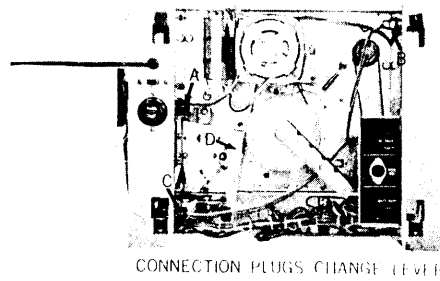

9

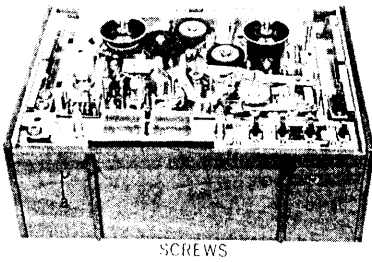

13

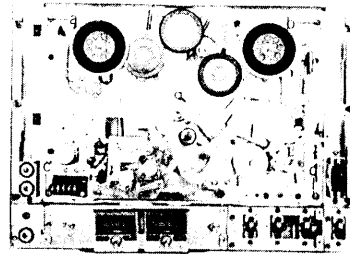

10

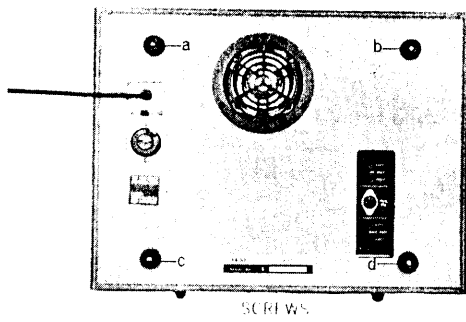

14

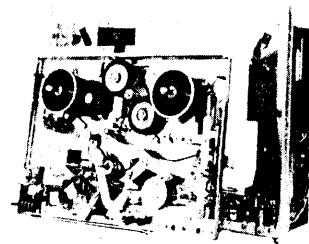

11

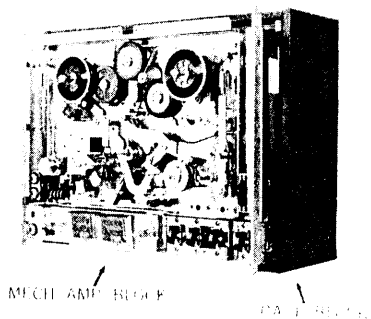

15

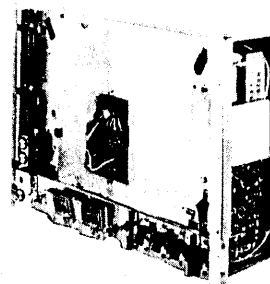

IV. MECHANISM ADJUSTMENTS

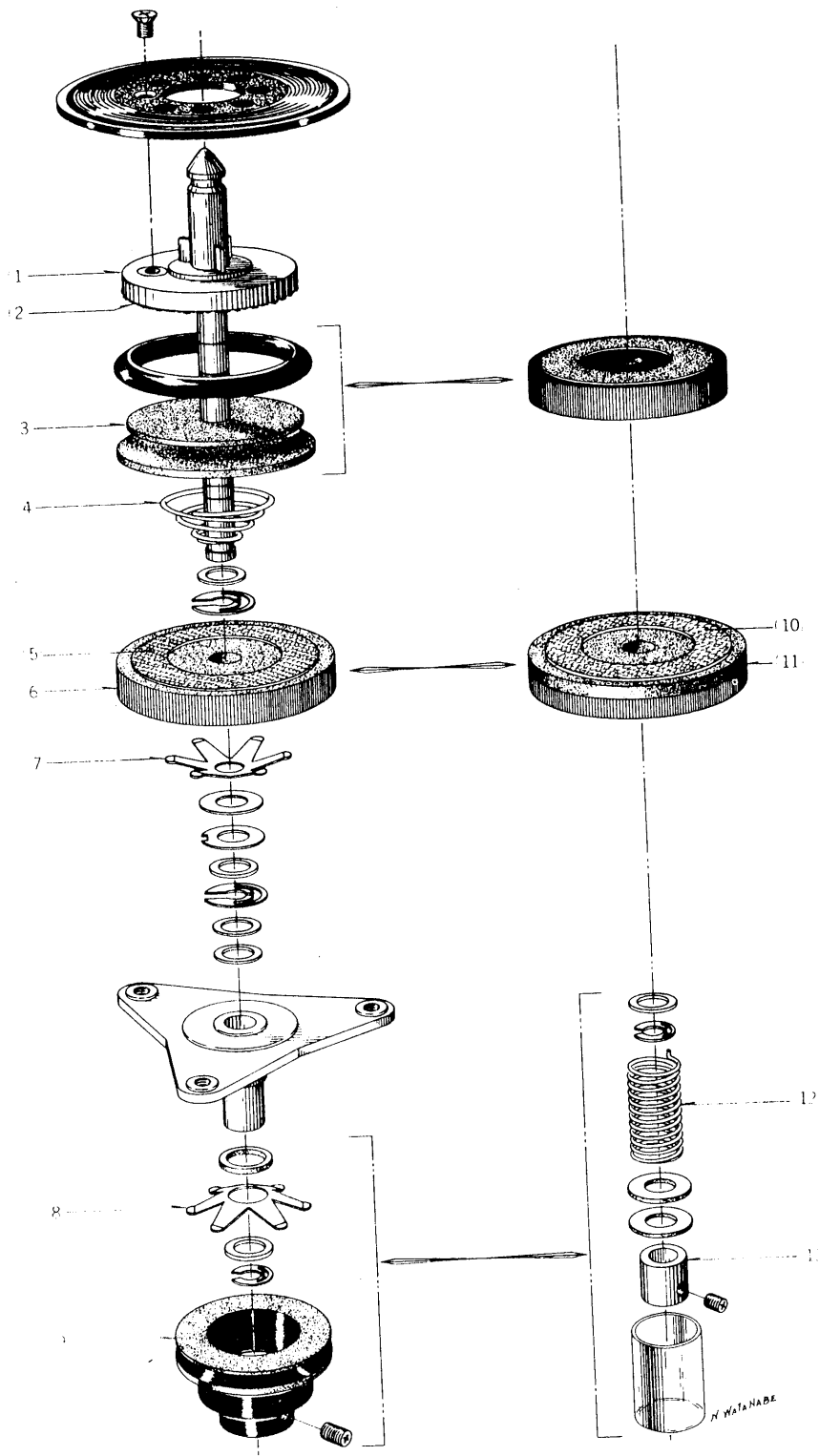

Fig. 7

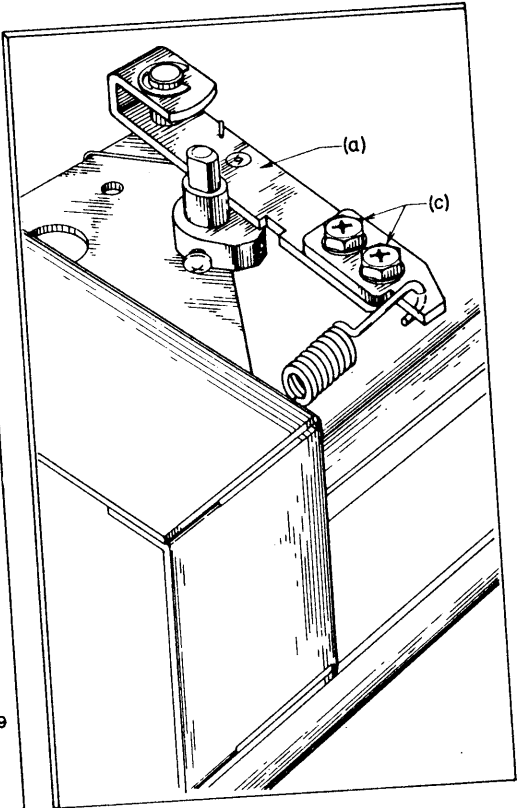
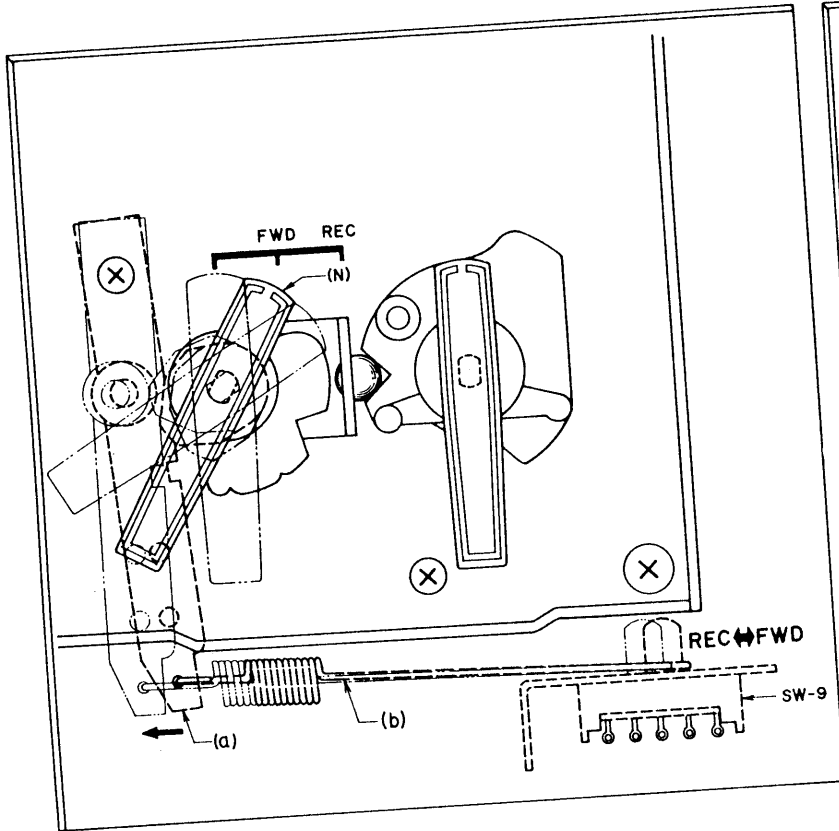

Fig. 8

Fig. 9

1. PINCH WHEEL ADJUSTMENT

It is important that the pinch wheel shaft be kept in perfect alignment with the capstan shaft. Proper pinch wheel pressure is between 1,000 and 1,150 grams when the unit is operated at the tape speed of 7½ ips. Any deviation from this specification will result in wow and flutter. Check pinch wheel pressure with a spring scale, and if necessary, adjust the pinch wheel load spring.

2. SUPPLY REEL SHAFT ASSEMBLY ADJUSTMENT (See Fig. 7 at left)

Felt clutch material (2) is used between the lower side of the reel table base plate (1) and the rewind pulley (3) to protect recording tape from excessive tension during rewind operation. To check the amount of friction of this part, install a 5-inch reel with a 60 mm diameter tape, and gently pull the end of the tape upward with a spring scale. Adjust the conical spring (4) so that the amount of tension is kept between 400 and 500 grams. Other felt clutch material (5) is attached to the supply roller (6) to provide proper slippage during FWD and REC operation. The procedure for checking friction of this part is the same as the foregoing, and between 80 and 100 grams of tension gives best result. Adjust the spring (7) just under the supply roller (6). When the unit is set to fast forward operation, the amount of friction will decrease to from 15 to 20 grams. Check to see whether this is satisfactory. If not, adjust the spring plate (8) and the pressure of the pulley. (9).

3. TAKE-UP REEL SHAFT ASSEMBLY ADJUSTMENT (See Fig. 7 at right)

Felt clutch material (2) is attached to the bottom side of the reel table base plate (1) so that the recording tape will not stretch during fast forward operation due to excessive tension. To check the amount of friction of this part, install a 5-inch reel with a 60 mm diameter tape, and gently pull the end of tape upward with a spring scale. Adjust the conical spring (4) so that the amount of tension at this part is kept between 400 and 500 grams. Other felt clutch material (10) is attached to the take-up roller (11). This is to provide proper slippage during FWD or REC operation. The procedure for checking friction of this part is the same as the foregoing, and between 150 and 180 grams of friction provides the best results. Adjust the spring plate (7) just under the take-up roller (11). When the unit is set to rewind operation, the amount of friction of this part will decrease to from 15 to 20 grams. Check to see whether this is satisfactory. If not, adjust the spring (12) and the pressure of the set sleeve (13).

4. RECORDING/PLAYBACK CHANGING MECHANISM (See Figs. 8, 9)

Turning The FWD/REC knob (N) to recording position causes Lever (a) to pull. Recording Lever (b) (as illustrated by dotted line), and the FWD/REC changing Switch (SW-9) is turned to recording position. If Lever (a) does not pull Lever (b) properly, Changing Switch SW-9 will not operate properly. This may cause abnormal oscillation and inability to record. In this case, loosen Screw (c) and adjust lever.

V. HEAD ADJUSTMENTS

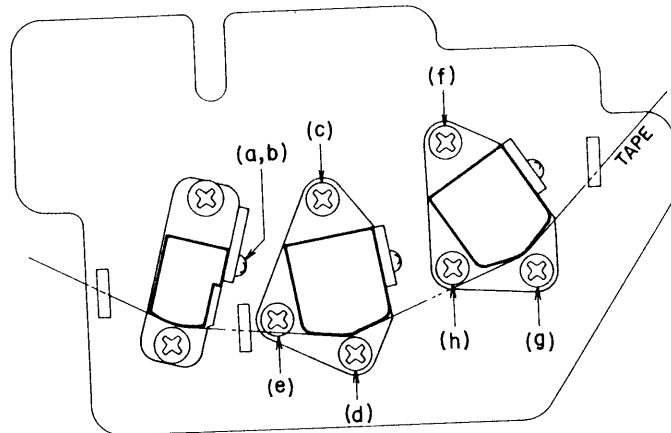

Fig. 10

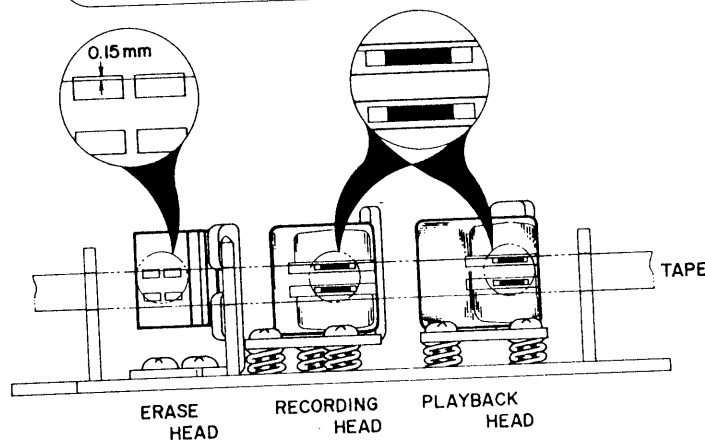

Fig. 11

Since adjustment of the Heads critically affects tape recorder performance, it is essential that Heads be carefully adjusted with precision measuring equipment and suitable recorded tape.

1. HEAD HEIGHT ADJUSTMENTS (See Figs. 10, 11)

- 1) Erase Head
Adjust height control screws (a), (b) by turning to left and right so that the upper edge of the tape is 0.15 mm lower than the upper edge of the erase head core.
- 2) Recording Head
Adjust the screws (c), (d) by turning to left and right until the width between the upper edge of channel 1 head core and upper edge of the tape is equal.
- 3) Playback Head
Adjust the screws (f), (g) by turning to left and right until the width between the upper edge of channel 1 head core and upper edge of the tape is equal.

2. HEAD SLANT ADJUSTMENT (See Figs. 10, 11)

Adjust the screws (Head Height control screw) by turning to left and right so that each head (Erase, Recording and Playback Head) contacts the tape surface at a right angle.

3. HEAD AZIMUTH ALIGNMENT ADJUSTMENTS (See Figs. 10, 11)

- 1) Playback Head
Playback an Ampex Alignment test tape (8,000 Hz 3¼ ips.) at 7½ ips. Adjust screw (h) by turning to left and right until the various line outputs are maximum.
- 2) Recording Head
At recording mode, supply a 15,000 Hz sine wave at a -16 dB recording level an Audio Frequency Oscillator to the line input of the 4000DS, and set the monitor switch to "TAPE" position. Then adjust screw (e) by turning to left and right until the various line outputs are maximum.

4. Repeat adjustments outlined in Items 1-2) to 3, above 2 or 3 times to obtain optimum adjusted condition.

VI. AMPLIFIER ADJUSTMENTS

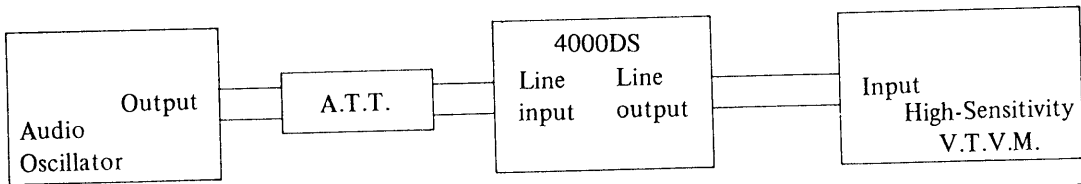

Fig. 12

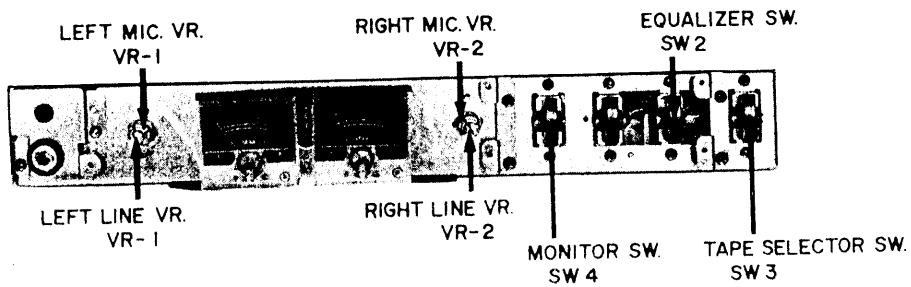

Fig. 14

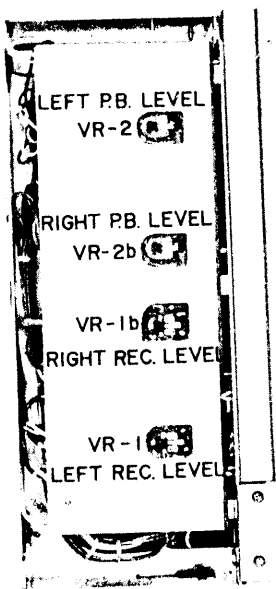

Fig. 13

1. PLAYBACK LEVEL ADJUSTMENT

(See Figs. 12, 13, and 14)

- 1) Set the monitor switch to "TAPE" position and Equalizer switch to $7\frac{1}{2}$ ips.
- 2) Connect a High Sensitivity V.T.V.M. to the line output.
- 3) Playback a 250 Hz pre-recorded test tape at $7\frac{1}{2}$ ips., and adjust semi-fixed resistor VR-2 and VR-2b (20 k Ω) to obtain a 4 dB P.B. level. (VU meter indicates "0" VU)

Recording Amplifier Adjustment should be made only after Head Adjustments and Playback Amplifier Adjustments have been made.

2. RECORDING LEVEL ADJUSTMENT

(See Figs. 12, 13, and 14)

- 1) Set the monitor switch to "TAPE" position and Equalizer switch to $7\frac{1}{2}$ ips.
- 2) Connect an Audio Frequency Oscillator to the line input and High Sensitivity V.T.V.M. to the line output.
- 3) Load a Scotch-111 blank tape and set recorder to "REC" mode.
- 4) Supply a 1,000 Hz sine wave from an Audio Frequency Oscillator and adjust the line recording level control volumes (VR-1 and VR-2 50 k Ω) until the line output level reaches 4 dB. (VU meter indicates "0" VU)
- 5) Set the monitor switch to "SOURCE" position.
- 6) Adjust semi-fixed resistor VR-1 and VR-1b (2 k Ω) to obtain 4 dB recording level. (VU meter indicates "0" VU)
- 7) Repeat 2 times in the same way as indicated in Items 4) to 6) above.

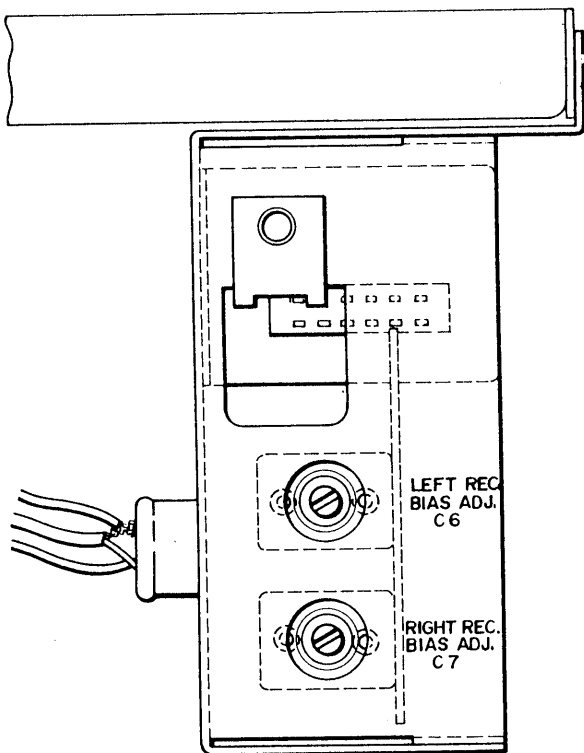

Fig. 15

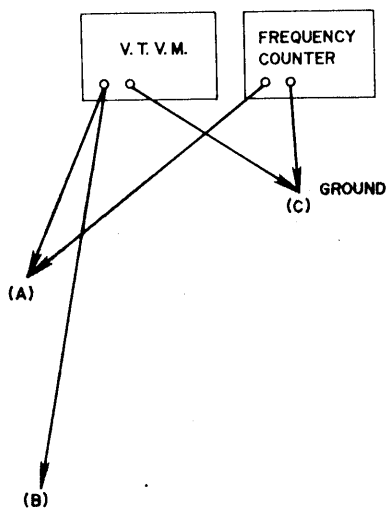

Fig. 16

3. RECORDING BIAS FREQUENCY ADJUSTMENT (See Fig. 16)

- 1) Set the recorder to recording mode.
- 2) Connect a Frequency counter to points (A) and (C) in Fig. 16 of the oscillator P.C. Board (LE-5021) and read the frequency indication.
- 3) If the bias frequency is $105 \text{ kHz} \pm 5\%$, the bias frequency is correct.
- 4) If the bias frequency is incorrect, it can be adjusted by changing the value of condenser C8 (5600 PF) of the oscillator P.C. Board (LE-5021)

4. RECORDING BIAS VOLTAGE ADJUSTMENT (FREQUENCY RESPONSE ADJUSTMENT) (See Figs. 15, 16)

- 1) Set the monitor switch to "TAPE" position and equalizer switch to $7\frac{1}{2}$ ips.
- 2) Connect an Audio Frequency Oscillator to the line input through an Attenuator and a High Sensitivity V.T.V.M. to the line output.
- 3) Load a blank test tape "AKAI 100L" (Fuji S-100) and set the recorder to "REC" mode.
- 4) Turn recording level control volume VR-1 and VR-2 (50k A) to obtain 4 dB V.T.V.M. reading.
- 5) Under conditions described in Item 4) above, readjust attenuator so that the line output level is -16 dB.
- 6) Record from 40 to 20,000 Hz spot frequencies.
- 7) Adjust Bias Adjustment semi-fixed condenser C6 (70 PF max.) so that the output of 1,000 Hz and 15,000 Hz frequencies are equal.
- 8) The bias voltage at this time is around 11V A.C.

5. ERASE VOLTAGE

- 1) Set the recorder to "REC" mode.
- 2) Connect a V.T.V.M. to points (B) and (C) in Fig. 16 of the oscillator P.C. Board (LE-5021) and read the V.T.V.M. indication.
- 3) The Erase Voltage is around 52V A.C.

VII. COMPOSITE VIEWS OF COMPONENTS

PRE-AMP. P.C. BOARD (LE-5022)

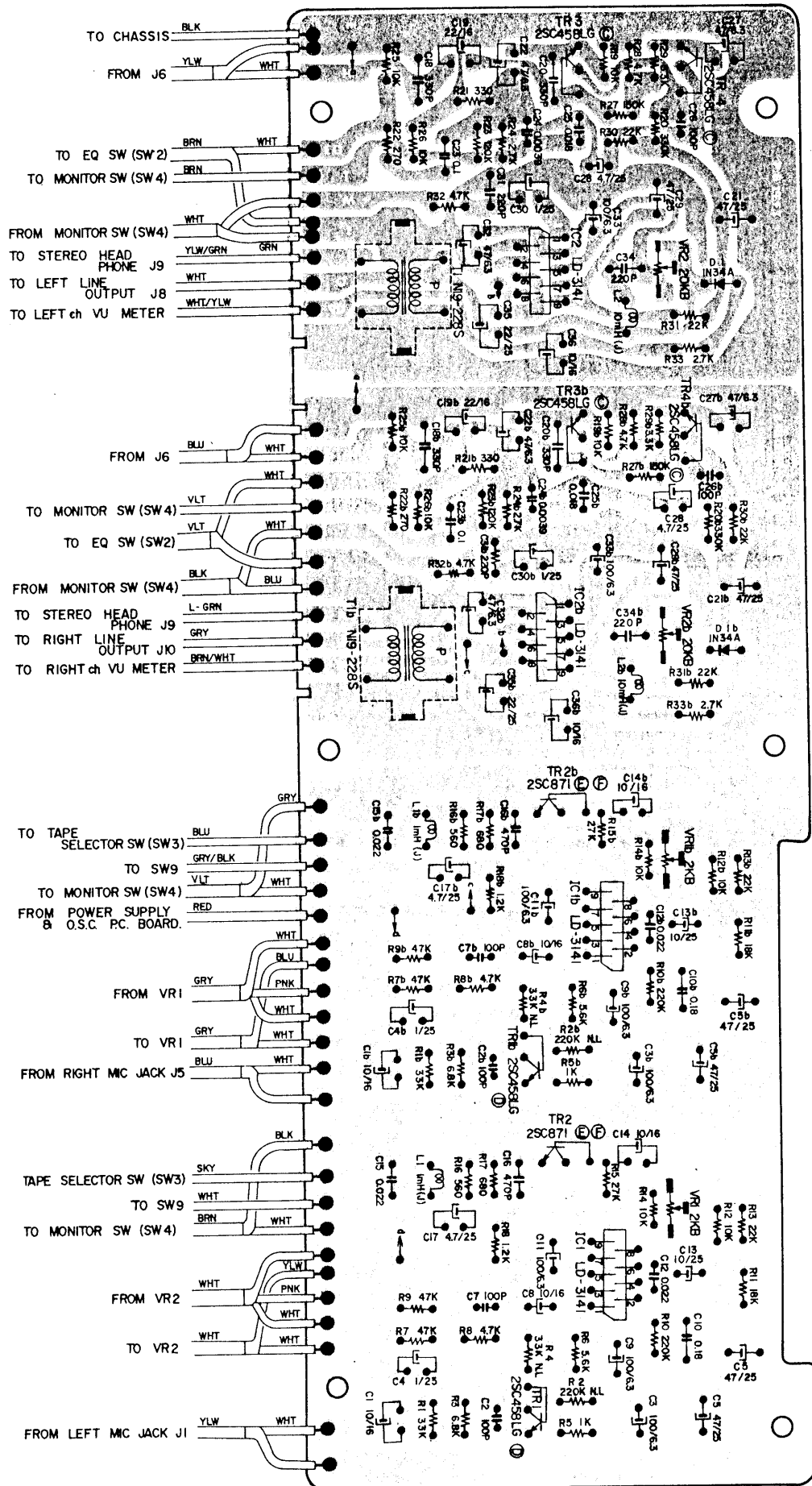

OSC. POWER P.C. BOARD (LE-5021)

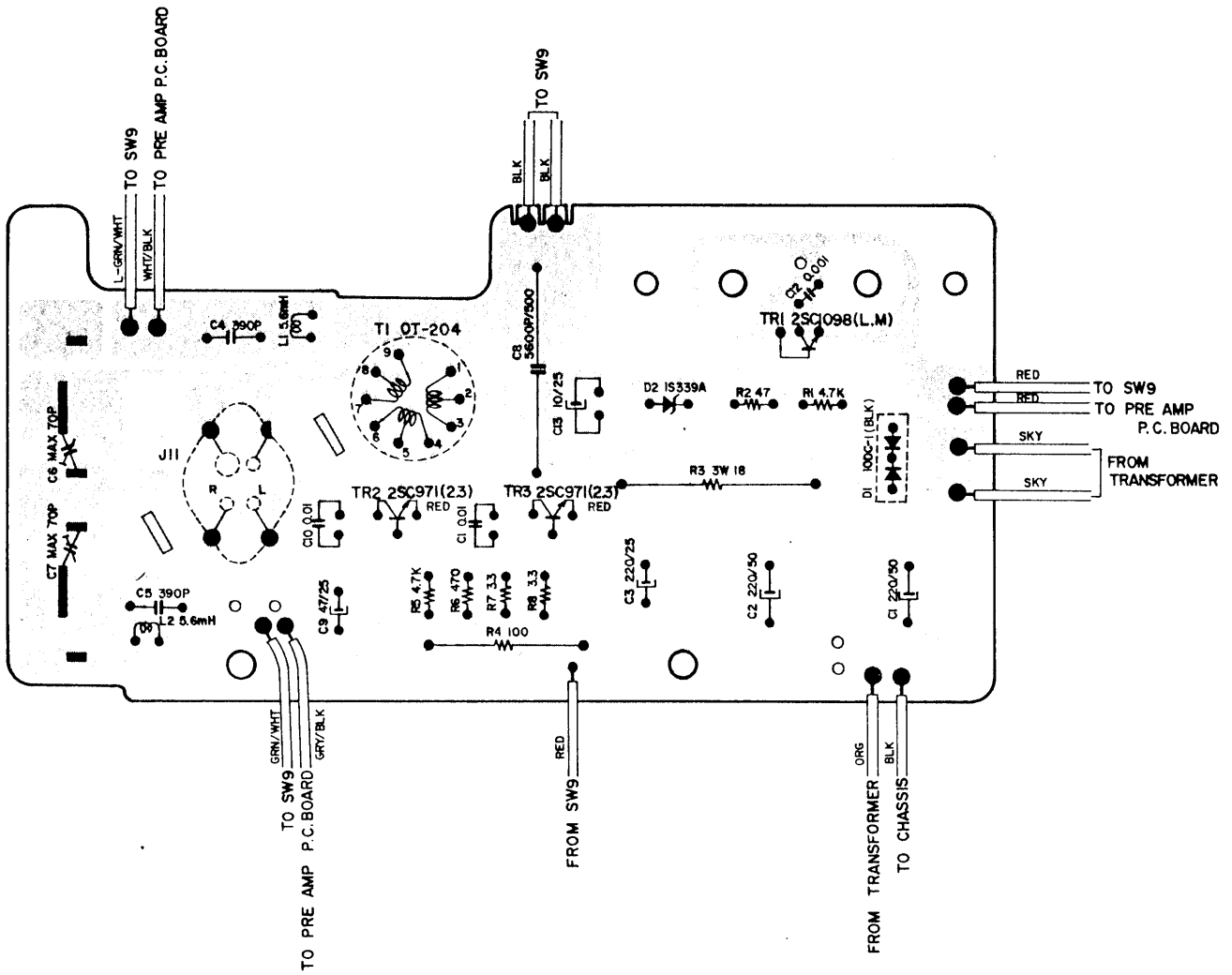

SECTION 2

PARTS LIST

TABLE OF CONTENTS

FIG. 1	HEAD BLOCK	21
FIG. 2	SUPPLY/TAKE-UP REEL TABLE BLOCK	23
FIG. 3	MOTOR BLOCK	24
FIG. 4	FLYWHEEL/BELT CHANGE LEVER BLOCK	25
FIG. 5	SWITCH BLOCK	26
FIG. 6	MECHANISM ASSEMBLY BLOCK	28
FIG. 7	PRE-AMP. P.C. BOARD (LE-5022) BLOCK	29
FIG. 8	OSC. POWER P.C. BOARD (LE-5021) BLOCK	30
FIG. 9	AMP. ASSEMBLY BLOCK	30
FIG. 10	FINAL ASSEMBLY BLOCK	33
INDEX	34

For Service Manuals
MAURITRON SERVICES
8 Cherry Tree Road, Chinnor
Oxfordshire, OX9 4QY.
Tel (01844) 351694
Fax (01844) 352554
email:- mauritron@dial.pipex.com

HOW TO USE THIS PARTS LIST

1. This parts list is compiled by various individual blocks based on assembly process.
2. When ordering parts, please describe parts number, serial number, and model number in detail.
3. How to read list.

The reference number corresponds with illustration or photo number of that particular parts list.

This number corresponds with the Figure Number.

This number corresponds with the individual parts index number in that figure.

A small "x" indicates the inability to show that particular part in the Photo or Illustration.

12-115x

Schematic Diagram Number of individual manufactured part.
(not required for parts order)

Quantity of particular part required.

Ref. No.	Parts No.	Description	Schematic No.	Q'ty
FLYWHEEL BLOCK #13				
12-115x	800425	Flywheel Block Assy. Comp.	RDG#13	1
12-116	244506	Flywheel Only	RD-233	1
12-117x	244754	Felt, Flywheel	RD-275	1
12-118	251324	Main Metal Case	RD-236	1
12-119	253080	Main Metal	RD-237	1

4. The symbol numbers shown on the P.C. Board list can be matched with the Composite Views of components of the Schematic Diagram or Service Manual.
5. The indications of Resistors and Capacitors in the photos of P.C. Board are being eliminated.
6. The shape of the parts and parts name, etc. can be confirmed by comparing them with the parts shown on the Electrical Parts List Table of P.C. Board.
7. Both the kind of part and installation position can be determined by the Parts Number. To determine where a parts number is listed, utilize Parts Index at end of Parts List.
It is necessary first of all to find the Parts Number. This can be accomplished by using the Reference Number listed at right of parts number in the Parts Index. (meaning of ref. no. outlined in Item 3 above).
8. Utilize separate "Price List for Parts" to determine unit price. The most simple method of finding parts Price is to utilize the reference number.

ELECTRICAL PARTS LIST TABLE

















<p>Because the indication of resistors and capacitors in the P. C. Board photos are being eliminated, please confirm parts name and shape by comparing them with the parts shown in this table.</p>	<p style="text-align: center;">1</p>  <p style="text-align: center;">Solid Resistor</p>	<p style="text-align: center;">2</p> <p style="text-align: right;">Stopper Type</p>  <p style="text-align: center;">Insulator Type</p> <p style="text-align: center;">Carbon Resistor</p>	<p style="text-align: center;">3</p>  <p style="text-align: center;">Metal Oxide Film Resistor</p>
<p style="text-align: center;">4</p>  <p style="text-align: center;">Cement Resistor</p>	<p style="text-align: center;">5</p>  <p style="text-align: center;">Wire-Wound Resistor</p>	<p style="text-align: center;">6</p>  <p style="text-align: center;">Thermistor</p>	<p style="text-align: center;">7</p>  <p style="text-align: center;">Enamel Resistor</p>
<p style="text-align: center;">1</p>  <p style="text-align: center;">MP Capacitor (Tubler Type)</p>	<p style="text-align: center;">2</p>  <p style="text-align: center;">Plastic Capacitor</p>	<p style="text-align: center;">3</p>  <p style="text-align: center;">Mylar Capacitor</p>	<p style="text-align: center;">4</p>  <p style="text-align: center;">VFM (Hi-Q) Capacitor</p>
<p style="text-align: center;">5</p>  <p style="text-align: center;">Mylar Capacitor</p>	<p style="text-align: center;">6</p>  <p style="text-align: center;">Tantalum Capacitor</p>	<p style="text-align: center;">7</p>  <p style="text-align: center;">Oil Capacitor (Tubler Type)</p>	<p style="text-align: center;">8</p> <p style="text-align: right;">Vertical Type</p>  <p style="text-align: center;">Tubler Type</p> <p style="text-align: center;">Styrol Capacitor</p>
<p style="text-align: center;">9</p>  <p style="text-align: center;">Electrolytic Capacitor (Tubler Type)</p>	<p style="text-align: center;">10</p> <p style="text-align: right;">Vertical Type</p>  <p style="text-align: center;">Tubler Type</p> <p style="text-align: center;">Electrolytic Capacitor</p>	<p style="text-align: center;">11</p>  <p style="text-align: center;">Ceramic Capacitor</p>	<p style="text-align: center;">12</p>  <p style="text-align: center;">Metalized Mylar (Paper) Capacitor</p>
<p style="text-align: center;">13</p>  <p style="text-align: center;">Trimmer Condenser</p>		<p style="text-align: center;">VR</p>  <p style="text-align: center;">Semi-Fixed Volume</p>	
<p style="text-align: center;">L</p>  <p style="text-align: center;">Ferri Inductor</p>	<p style="text-align: center;">TR</p>  <p style="text-align: center;">Transistor</p>		
<p style="text-align: center;">CR</p>  <p style="text-align: center;">Spark Quencher</p>	<p style="text-align: center;">D</p>  <p style="text-align: center;">Diode (Silicon, Zener, Germanium)</p>		

FIG. 1 ILLUSTRATION OF HEAD BLOCK

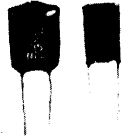

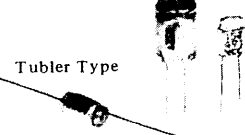
For Service Manuals
MAURITRON SERVICES
 8 Cherry Tree Road, Chinnor
 Oxfordshire, OX9 4QY.
 Tel (01844) 351694
 Fax (01844) 352554
 email:- mauritron@dial.pipex.com

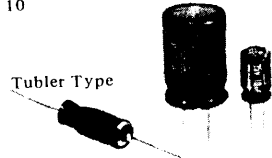
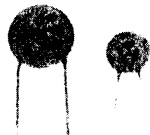
HEAD BLOCK

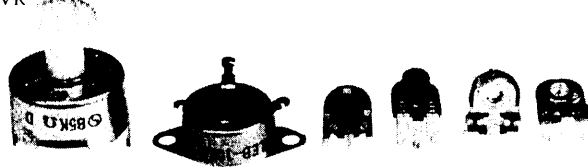
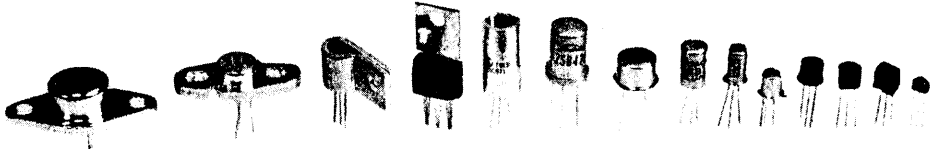
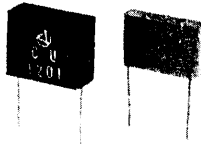
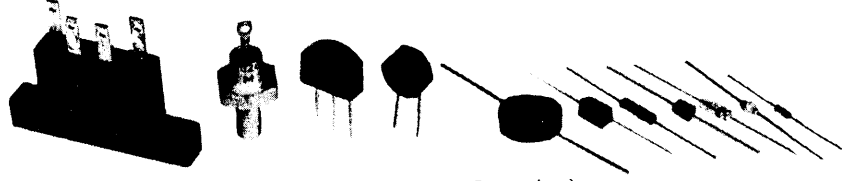
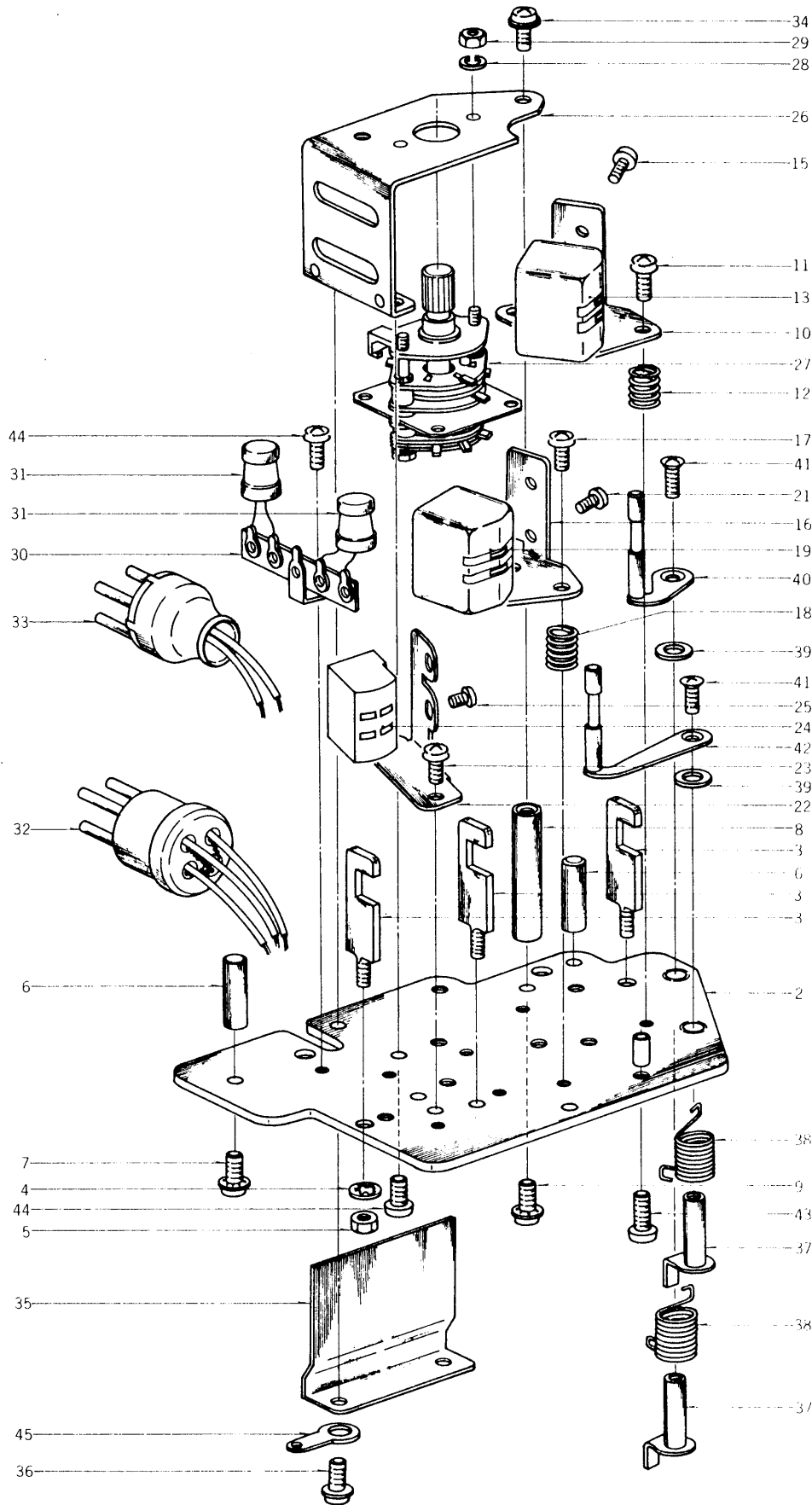
Ref. No.	Parts No.	Description	Schematic No.	Q'ty
1-1x	BH480363	Head Block Comp.	LE-1	1
1-2	HZ490296	LD Head Base B (new), w/metal	LD-11	1
1-3	HZ274162	Tape Guide #1	4TR-5	3
1-4	ZW273802	M3 Toothed Lock Washer		3
1-5	ZW273756	M3 Nut		3
1-6	SZ247015	Head Cover Prop	LD-10	2
1-7	ZW417025	Screw, binding head 3x8, w/washer		2
1-8	MH312827	SW. Prop (new LD)	LD-13	1
1-9	ZW417025	Screw, binding head 3x8, w/washer		1
1-10	HZ480420	PB. Angle Base	LE-0001	1
1-11	ZW464714	Screw, round head 3x12		3
1-12	ZG206144	Angle Adjust Spring	RD-16	3
1-13	HP375131	REC./PB. HEAD P4-150		1
1-14x	HZ393974	I-MK Head Terminal Plate	RC-89	1
1-15	ZW477876	Screw, pan head 2x3		2
1-16	HZ480431	Rec. Angle Table	LE-0002	1
1-17	ZW464714	Screw, round head 3x12		3
1-18	ZG206144	Angle Adjust Spring	RD-16	3
1-19	HR475446	REC. HEAD P4-154		1
1-20x	HZ393974	I-MK Head Terminal Plate	RC-89	1
1-21	ZW477876	Screw, pan head 2x3		2
1-22	HZ480442	Erase Head Base	LE-0003	1
1-23	ZW323728	Screw, binding head 3x5		2
1-24	HE384693	ERASE HEAD E4-200		1
1-25	ZW477876	Screw, pan head 2x3		2
1-26	HZ312895	Switch Table (new LD)	LD-12	1
1-27	ES257668	Rotary Switch ESR-E263L14AS	25-6-3	1
1-28	ZW273723	M2 Spring Washer		2
1-29	ZW273734	M2 Nut		2
1-30	EJ255115	Lug Plate VB2L2	33-4-3	1
1-31	EO390622	Ferri Inductor FL9H 220 μ H(K)	23-1-4	2
1-32	EJ297843	4-P Plug, w/cap	42-1-3	1
1-33	EJ276963	T type 4-P Plug	42-1-16	1
1-34	ZW417025	Screw, binding head 3x8, w/washer		1
1-35	HZ480475	Head Shield	LE-0004	1
1-36	ZW413223	Screw, binding head 3x5, w/washer		2
1-37	HL223503	Shift Lever B, w/shaft A	M9-3	2
1-38	ZG312928	Shifter Spring	LD-19	1
1-39	ZW336846	Washer (SPC)D4.1x7x1.2t		2
1-40	HL312941	Shift Lever, w/pin	LD-15	1
1-41	ZW480622	Screw, oval countersunk head 2.3x6		2
1-42	HL223536	Shift Lever C, w/pin	M9-5	1
1-43	ZW413155	Screw, binding head 3x6		1
1-44	ZW323728	Screw, binding head 3x5		2
1-45	ZW273778	M3 Earth Lug		1

When ordering parts, please describe Parts Number, Serial Number, and Model Number in detail.

FIG. 2 ILLUSTRATION OF SUPPLY/TAKE-UP REEL TABLE BLOCK

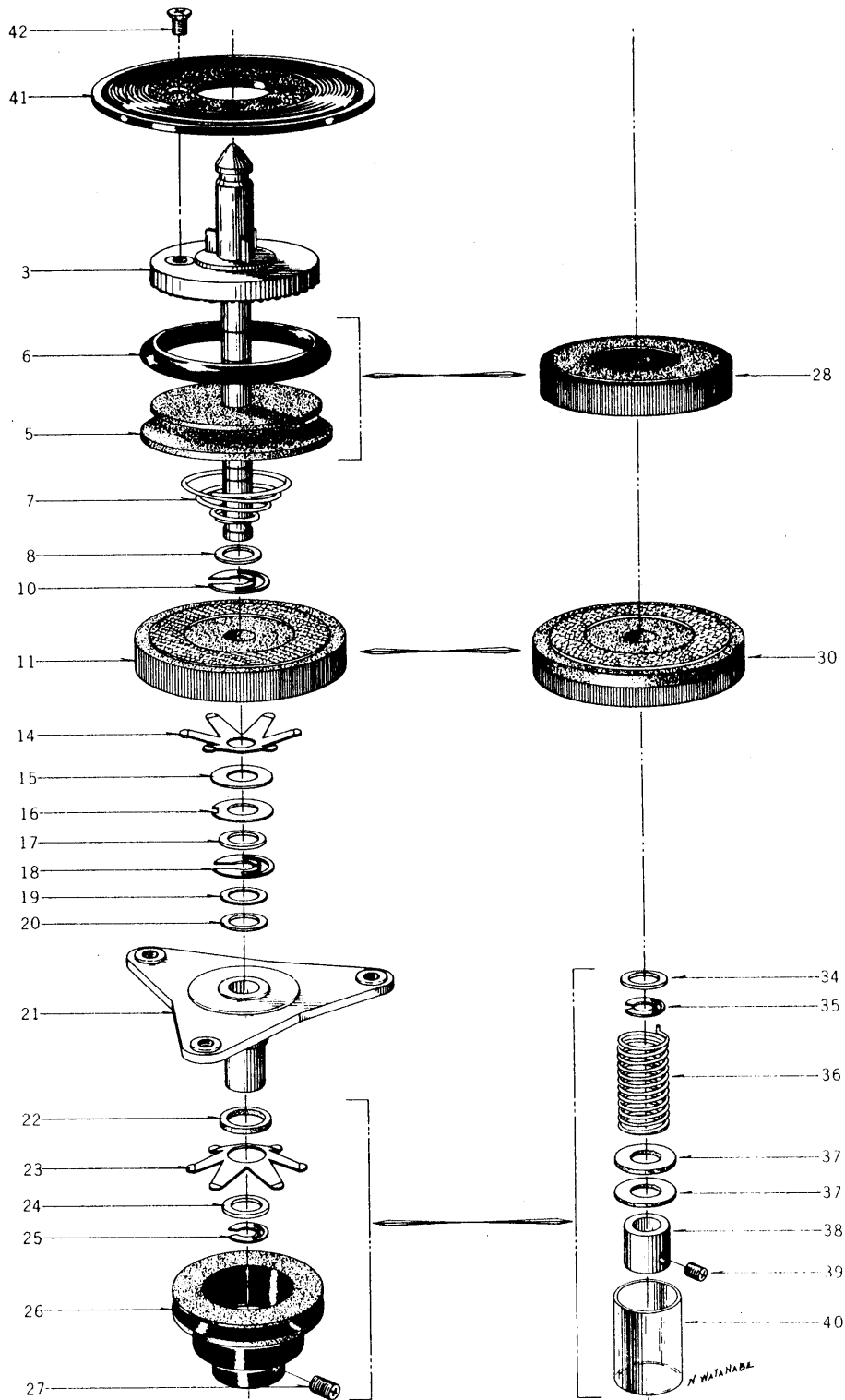

SUPPLY/TAKE-UP REEL TABLE BLOCK

Ref. No.	Parts No.	Description	Schematic No.	Q'ty
2-1x	BR205020	Supply Reel Table Block		
		#5 Comp.	I.E. I.D	1
2-2x	BR205244	Take-up Reel Table Block		
		#7 Comp.	I.E-1, I.D	1
2-3	MT256140	Reel Table C, w/shaft C	900-215	2
2-4x	MT252112	Friction Cloth B	900-225	2
2-5	MR251460	Rewind Pulley	900-222	1
2-6	MT222366	Rubber Ring	900-234	1
2-7	ZG227531	Spring G1 (L)	900-229	1
2-8	ZW260054	Washer (SUP)D6.1x10x0.25t		2
2-9x	ZW260065	Washer (SUP)D6.1x10x0.35t		2
2-10	MT255870	Reel Table Thrust Pin	900-237	2
2-11	MR252066	Take-up Roller C	900-220	1
2-12x	MT252101	Friction Cloth A	900-224	1
2-13x	ZW260098	Washer (SUP)D6.1x10x0.5t		2
2-14	MT255971	Reel Table Spring Plate A	900-227	1
2-15	ZW260201	Washer (Nylon)D6.2x13x1t		2
2-16	ZW231693	Claw Thrust Washer		
		(SUP)0.25t	900-235	2
2-17	ZW260201	Washer (Nylon)D6.2x13x1t		2
2-18	MT255870	Reel Table Thrust Pin	900-237	2
2-19	ZW260076	Washer (Nylon)D6.1x10x0.5t		2
2-20	ZW260065	Washer (SUP)D6.1x10x0.35t		4
2-21	MT256228	Reel Metal MT. Parts,		
		w/metal B	900-231	1
2-22	ZW260245	Washer (Nylon)D7.9x13x1t		1
2-23	MT255993	Reel Table Spring Plate C	M8-207	1
2-24	ZW260065	Washer (SUP)D6.1x10x0.35t		1
2-25	ZW270000	Retaining Pin D4	900-257	1
2-26	MR256083	Reel Table Pulley	900-239	1
2-27	ZW434171	Set Screw, hexagon socket		
		4x7(cup)		1
2-28	MR252044	Take-up Roller A	900-218	1
2-29x	ZG227520	Spring G1(R)	900-229	1
2-30	MR252055	Take-up Roller B	900-219	1
2-31x	MT252123	Friction Cloth C	900-226	1
2-32x	MT255982	Reel Table Spring Plate B	900-228	1
2-33x	MT256228	Reel Metal NT. Parts,		
		w/metal A	900-231	1
2-34	ZW260021	Washer (SUP)D6.1x10x0.13t		1
2-35	ZW312693	'E' Ring 4	6-1-4	1
2-36	ZG227496	Spring F3 (R)	900-238	1
2-37	ZW260201	Washer (Nylon)D6.2x13x1t		2
2-38	MT228587	Set Sleeve	M8-208	1
2-39	ZW434160	Set Screw, hexagon socket		
		3x3(cup)		1
2-40	MT235596	Vinyl Tube 15		1
2-41	MT480971	Reel Table Disk	I.E-2001	2
2-42	ZW461305	Screw, countersunk head		
		3x5(black)		2

When ordering parts, please describe Parts Number, Serial Number, and Model Number in detail.

FIG. 3 ILLUSTRATION OF MOTOR BLOCK

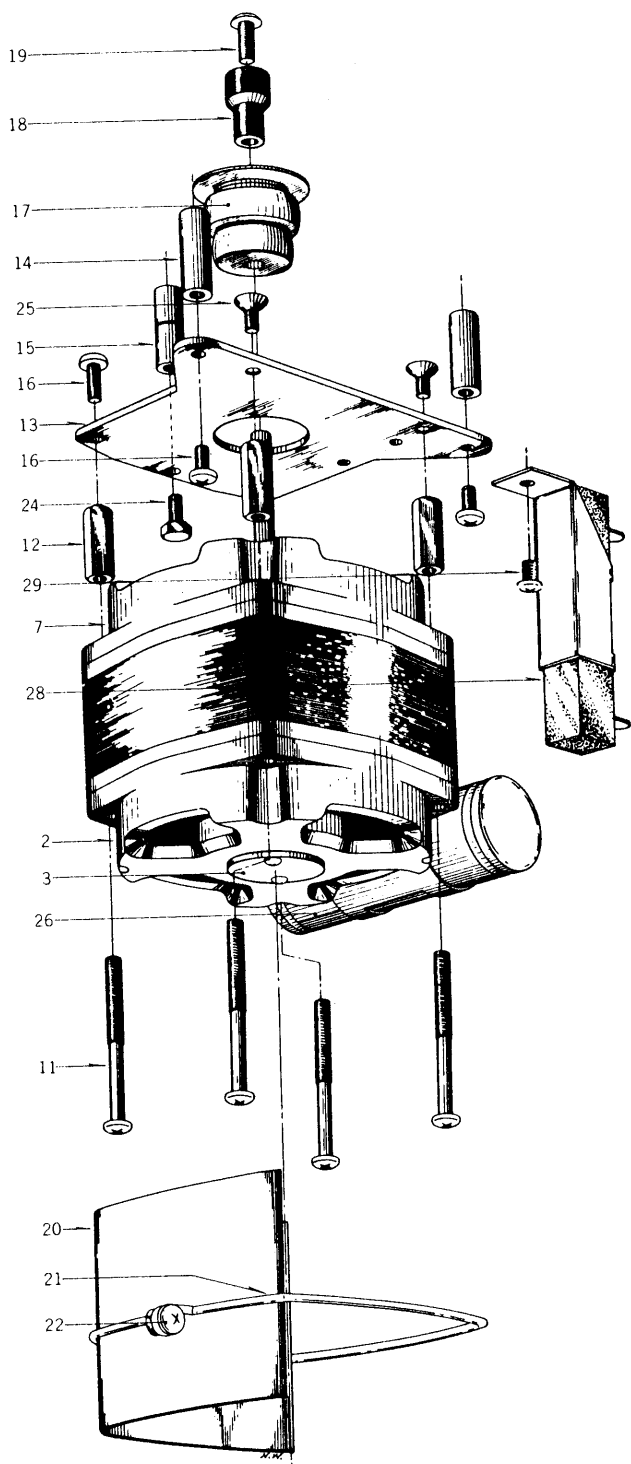

MOTOR BLOCK

Ref. No.	Parts No.	Description	Schematic No.	Q'ty
3-1x	BM271800	Motor Block Comp.	1.E-1, I.D	1
3-2	MZ395144	900 Motor Cover B, w/metal	900-709	1
3-3	UC254250	Motor Bottom Plate	900-721	1
3-4x	ZW384131	Screw, round head 3x5		2
3-5x	MZ257591	Rotor Fan	3A-758	2
3-6x	MV269965	Ball D4		1
3-7	MZ395166	900 Motor Cover A, w/metal	900-707	1
3-8x	ZW260245	Washer (Nylon)D7.9x13x1t		1
3-9x	MZ253956	Motor Oil Cap D	900-725	1
3-10x	EZ335204	Felt D14x19x4t	900-744	1
3-11	ZW427037	Screw, pan head 4x50, w/washer		4
3-12	ZW254621	Motor Hexagon Nut	900-737	4
3-13	MZ254351	Motor Mt. plate A.	900-738	1
3-14	MZ254160	Motor Prop A	24X-730	2
3-15	MZ254182	Motor Prop B	24X-731	1
3-16	ZW424056	Screw, pan head 4x10		5
3-17	MR254496	Motor Pulley	SRA-5	1
3-18	MR300644	900 Type Knurled Pulley	900-735	1
3-19	ZW300655	900 Type Knurled Pulley Set Screw	900-736	1
3-20	MZ292364	XR Motor Shield Plate B	XR-705	1
3-21	MB254158	Motor Shield Setting Band	1.D-701	1
3-22	ZW424056	Screw, pan head 4x10		1
3-23x	ZW413188	M4 Nut		1
3-24	ZW272395	M7 Motor Prop Set Screw	24X-732	1
3-25	ZW200474	Screw, countersunk head 4x10		2
3-26	EC410016	MP/C. 2+0.5μF 300VAC (Lug type Uni/D.)	24-9-13	1
3-27x	EC273442	MP/C. 2μF 250WVAC (Lug type Op./D.) (AAL,CSA)	24-9-20	1
3-28	ER339805	Cement/R. H20B 450Ω(K) (Wire-wound type), w/belt	35-16-16	1
3-29	ZW413223	Screw, binding head 3x5 w/washer		1

When ordering parts, please describe Parts Number, Serial Number, and Model Number in detail.

**FIG. 4 ILLUSTRATION OF FLYWHEEL/
BELT CHANGE LEVER BLOCK**

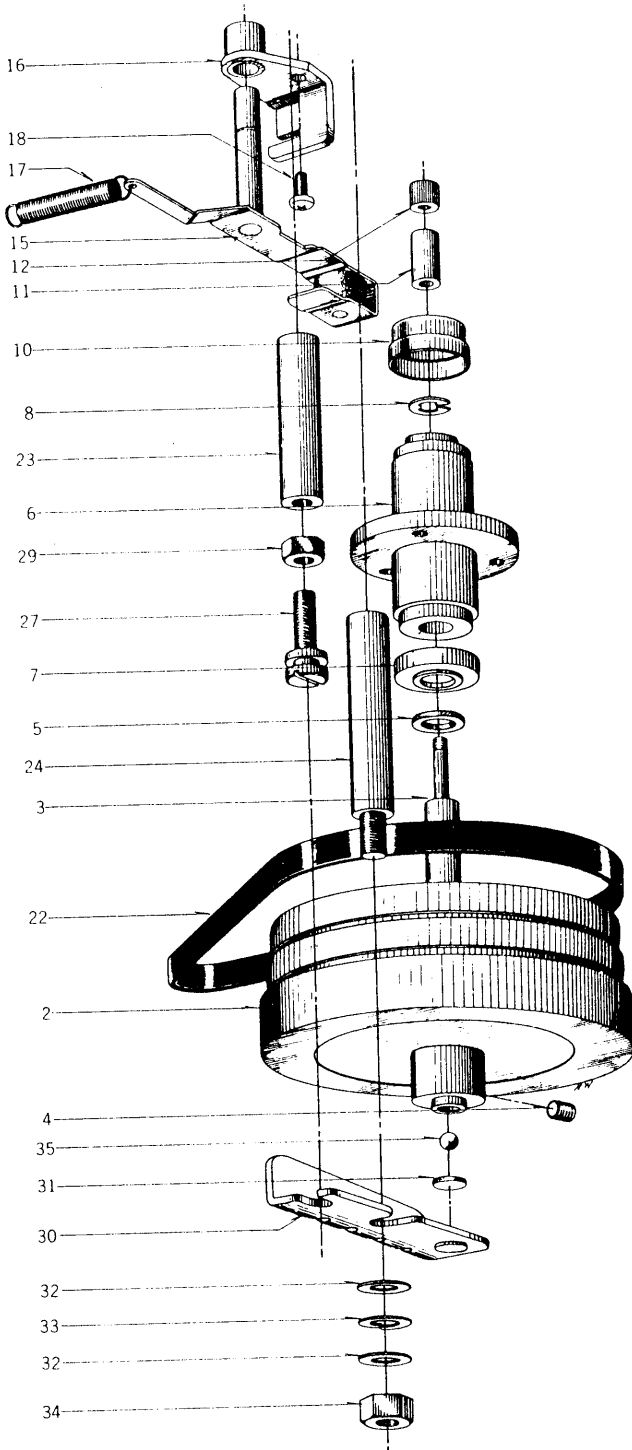

FLYWHEEL/BELT CHANGE LEVER BLOCK

Ref. No.	Parts No.	Description	Schematic No.	Q'ty
FLYWHEEL BLOCK				
4-1x	BF205075	Flywheel Block #5 Comp.		1
4-2	MZ244473	Flywheel	707-S-10	1
4-3	MS244708	Flywheel Shaft	SRA-21	1
4-4	ZW373577	Set Screw, hexagon socket 5x6(flat)		2
4-5	ZW447208	Flywheel Thrust B D7.9x13x0.5t	101025	1
4-6	MZ296267	Main Case B 24 Comp.	1630-205	1
4-7	MZ446635	Thrust Cap, Main Metal B2	LF-2006	1
4-8	ZW244710	Flywheel Fixing Pin	900-250	1
4-9x	MZ244113	Felt D12.5x16x2t		1
4-10	MZ253113	Main Metal Cap B	MH-208	1
4-11	MY270055	Capstan D8	SRA-7	1
4-12	ZW293027	1100 Capstan Screw	SRA-6B	1
4-13x	BC252977	Main Shaft Collar	SRA-32	1
BELT CHANGE LEVER BLOCK				
4-14x	BL203523	Belt Change Lever Block Comp. A		1
4-15	ML217451	Belt Change Lever (small), w/roller B	MH-221	1
4-16	MZ248354	Belt Guide Stop, w/metal	4TR-221	1
4-17	ZG217337	Belt Return Spring	4TR-224	1
4-18	ZW413201	Screw, pan head 4x8		1
4-19x	ZG217394	Belt Change Spring B	MH-125	1
4-20x	ZW260054	Washer (SUP)D6.1x10x0.25t		1
4-21x	ZW290283	'U' Ring 2.85M	6-1-1	1
4-22	MB256601	Double Face Flat Belt D=110	100912	1
4-23	MZ244631	Flywheel Prop B	4TR-115	1
4-24	MZ244620	Flywheel Prop A	4TR-116	1
4-25x	ZW424056	Screw, pan head 4x10		2
4-26x	ZW273914	M4 Spring Washer		2
4-27	ZW244574	Flywheel Support Adjust Screw	4TR-114	1
4-28x	ZW231794	Tape Guide Washer (small)	3A-355	1
4-29	ZW274048	M5 Nut		1
4-30	MZ244530	Flywheel Support Plate B	M8-109	1
4-31	ZW235585	Nylon Plate D=8		1
4-32	ZW413998	Washer (SPC)D6.8x12.7x1t		1
4-33	ZW393232	1/4 Inch Spring Washer		1
4-34	ZW413280	Inch Nut 1/4 Thread=20		1
4-35	MV269965	Steel Ball 4mm		1

When ordering parts, please describe Parts Number, Serial Number, and Model Number in detail.

FIG. 5 ILLUSTRATION OF SWITCH BLOCK

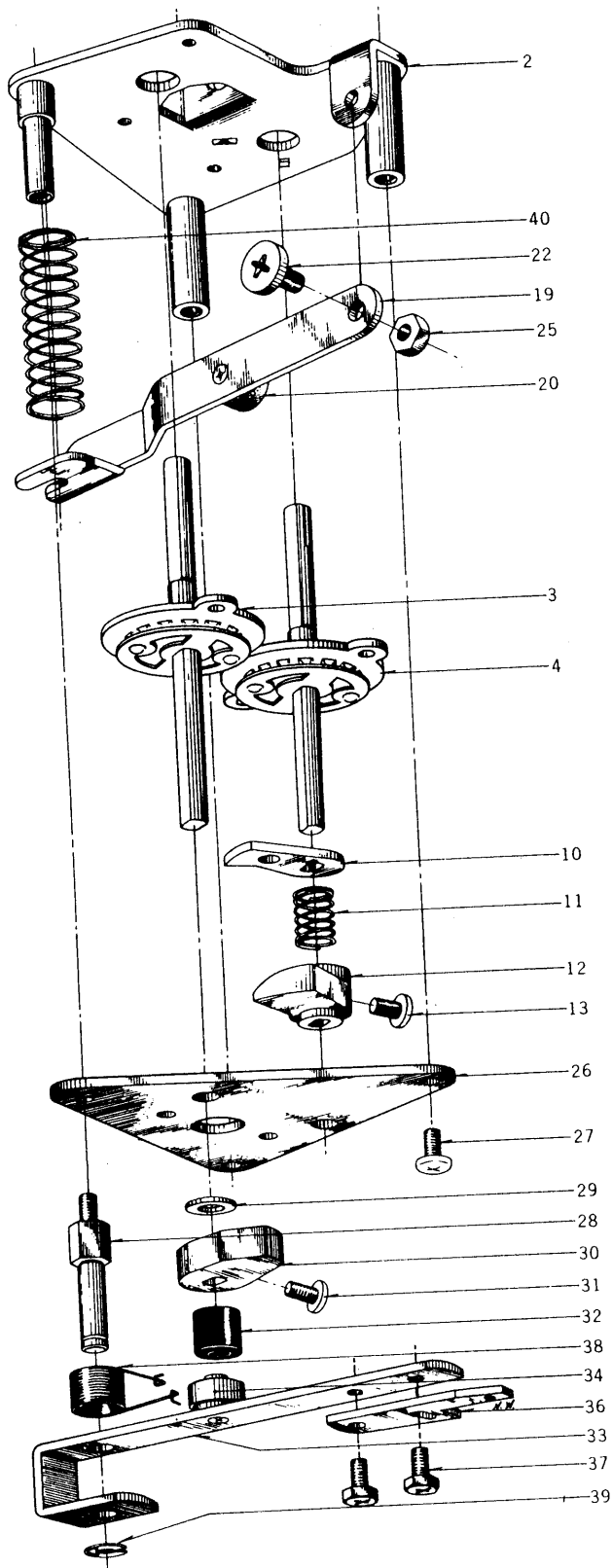

SWITCH BLOCK

Ref. No.	Parts No.	Description	Schematic No.	Q'ty
			I.E.	
5-1x	BS480352	Switch Block Comp.		1
5-2	MZ316901	Switch Table A-2 (SX), w/prop	MR-201	1
5-3	ES316934	Y Type RWD Shaft	25-8-5	1
5-4	ES369865	RCC Y Type RWD Shaft	RCC-202	1
5-5x	MZ316945	Nut Plate	MR-245	2
5-6x	ZW202138	Screw, binding head 3x6, w/washer		4
5-7x	MZ316956	Cam A-3	MR-242	1
5-8x	ZW413201	Screw, pan head 4x8		1
5-9x	ZW260133	Washer (Fiber)D6.1x10x1t		2
5-10	MZ327341	Cam Trap Plate B	SX-201	1
5-11	ZG227586	Spring K	900-214	1
5-12	MZ327352	Cam C-2	SX-202	1
5-13	ZW201778	Screw, pan head 4x8		1
5-14x	ZW434215	Washer (Nylon) D6.1x10.3x0.3t		1
5-15x	ZW434193	Washer (Nylon) D6.1x10.3x0.5t		1
5-16x	MV270066	Steel Ball D8	1630-201	1
5-17x	MZ217293	Cam B-2, without tap		1
5-18x	ZW416687	Screw, binding head 4x8		1
5-19	ML257128	Lever I, w/shaft	900-209	1
5-20	MZ217203	Cam Roller A	900-153	1
5-21x	ZW290283	'U' Ring 2.85M	6-1-1	1
5-22	ZW217877	Pause Lever Set Screw	900-136	1
5-23x	ZW260166	Washer (Nylon) D6.2x13x0.125t		1
5-24x	ZW273892	M4 Toothed Lock Washer		1
5-25	ZW273960	M4 Nut		1
5-26	MZ225720	Switch Table B-2	M9-308	1
5-27	ZW413201	Screw, pan head 4x8		2
5-28	MZ258581	Rec. Lever Prop	M9-303	1
5-29	ZW260133	Washer (Fiber)D6.1x10x1t		1
5-30	MZ317068	Amp. Switch Cam B	MR-243	1
5-31	ZW413201	Screw, pan head 4x8		1
5-32	MZ217686	Pause Lever Cushion	I.C-102	1
5-33	ML488744	Rec. Lever C, w/shaft B	I.E-2002	1
5-34	MR269728	Cam Roller D12.5	RC-126	1
5-35x	ZW290283	'U' Ring 2.85M	6-1-1	1
5-36	ML226146	Switch Lever BL	1.10-103	1
5-37	ZW203253	Hexagon Bolt 4x7, w/washer		2
5-38	ZG227564	Spring H	900-120	1
5-39	ZW290283	'U' Ring 2.85M	6-1-1	1
5-40	ZG227485	Spring E	900-119	1

When ordering parts, please describe Parts Number, Serial Number, and Model Number in detail.

FIG. 6 ILLUSTRATION OF MECHANISM ASSEMBLY BLOCK

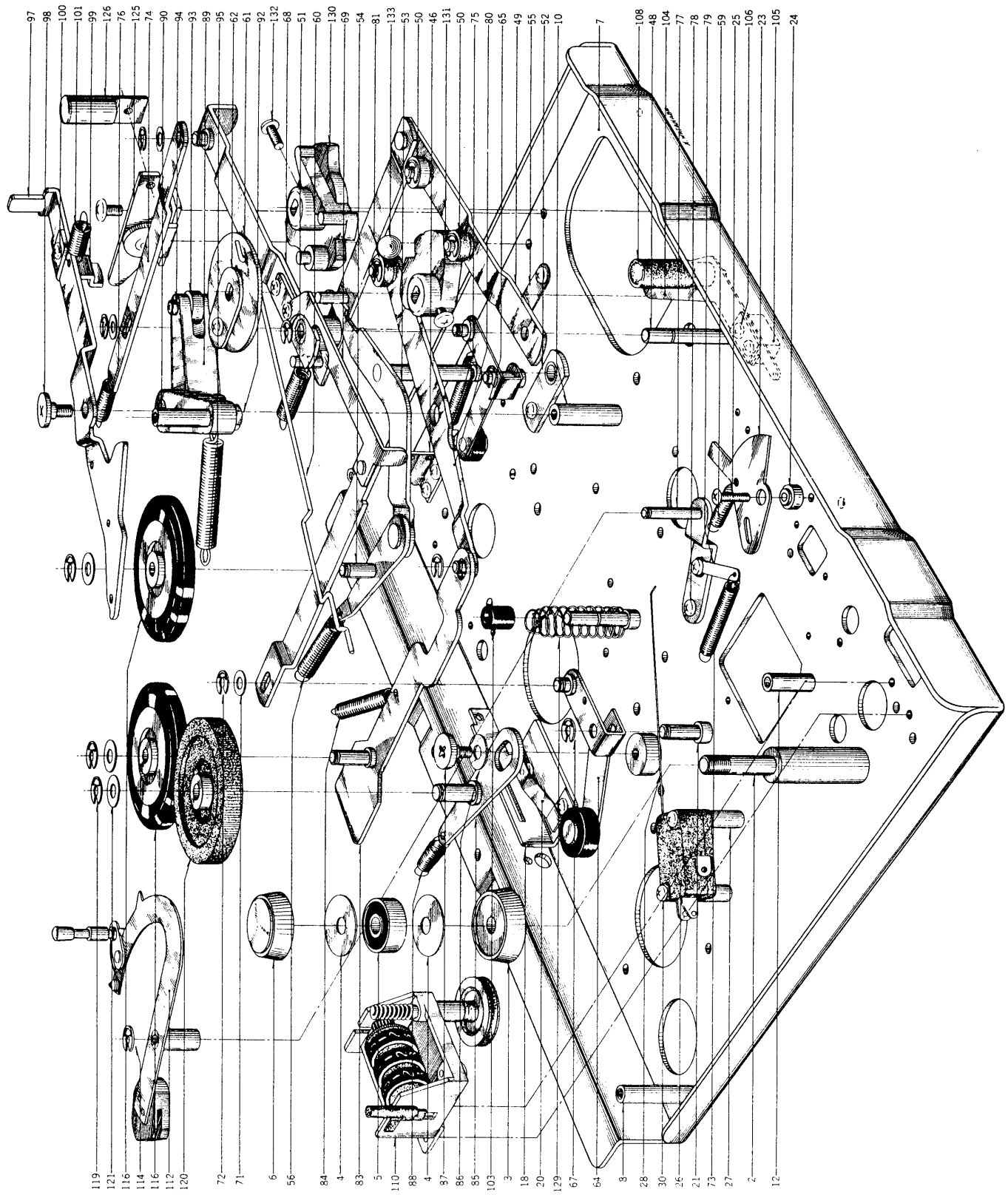
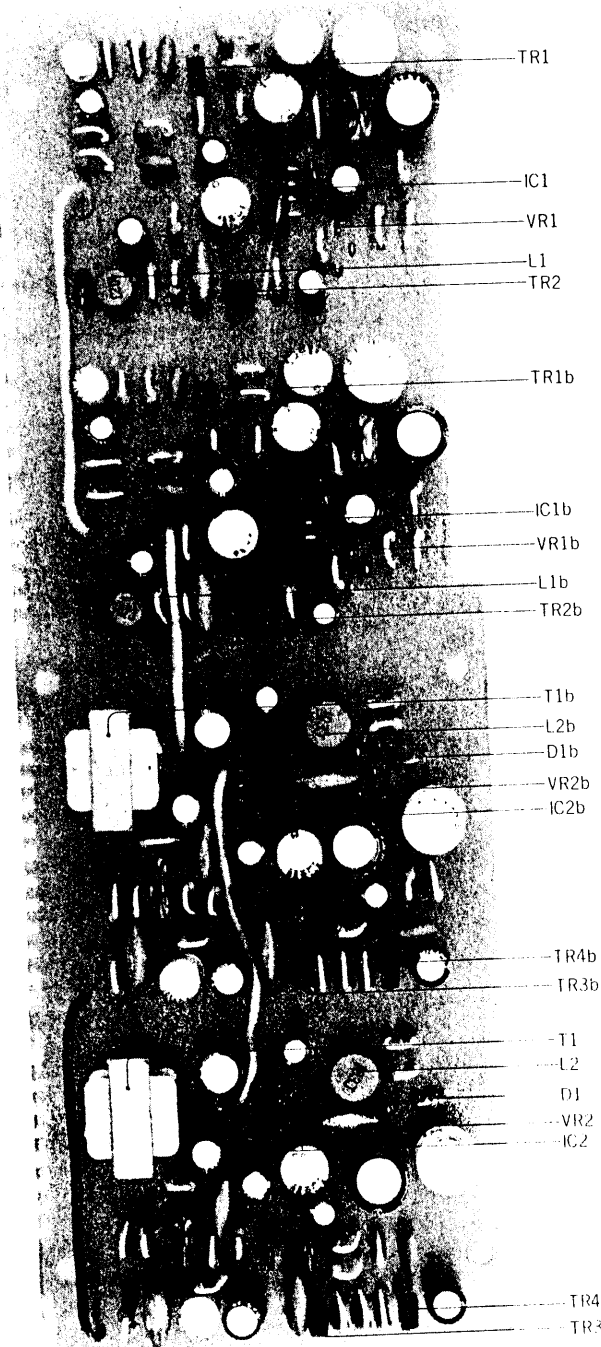

FIG. 7 PHOTO OF
PRE-AMP. P.C. BOARD (LE-5022)



PRE-AMP. P.C. BOARD (LE-5022) BLOCK

Symbol No.	Parts No.	Description	Q'ty
7-1x	BA480251	Pre-Amp. P.C. Board Comp. (LE-5022)	1
7-IC1,2	EI412413	Line Amp. I.C. LD-3141	4
7-TR1	ET352146	Transistor 2SC458LG(D)	2
7-TR2	ET398845	Transistor 2SC871(E,F)	2
7-TR3,4	ET234854	Transistor 2SC458LG(C)	4
7-D1	ED219464	Germanium Diode 1N34A	2
7-VR1	EV337577	Semi-fixed Volume V10K5-2-4 2k B	2
7-VR2	EV337588	Semi-fixed Volume V10K5-2-4 20k B	2

Symbol No.	Parts No.	Description	Q'ty
7-L1	EO243977	Ferri Inductor FL7H 1MH(J)	2
7-L2	EO244001	Ferri Inductor FL9H 10MH(J)	2
7-T1	BT247746	Head Phone Trans. N19-228S	2
Capacitor, Vertical Type			
7-C1	EC432810	Elect. 10 μ F 16WV(noiseless)	2
7-C2	EC290520	VFM 100PF(J) 50WV	2
7-C3	EC220364	Elect. 100 μ F 6.3WV	2
7-C4	EC493323	Elect. 1 μ F 25WV(noiseless)	2
7-C5	EC476965	Elect. 47 μ F 25WV(noiseless)	2
7-C6	EC220678	Elect. 47 μ F 25WV	2
7-C7	EC290520	VFM 100PF(J) 50WV	2
7-C8	EC320051	Elect. 10 μ F 16WV	2
7-C9	EC220364	Elect. 100 μ F 6.3WV	2
7-C10	EC446297	Mylar 0.18 μ F(J) 50WV	2
7-C11	MC220364	Elect. 100 μ F 6.3WV	2
7-C12	EC368335	Mylar 0.022 μ F(J) 50WV	2
7-C13	EC220994	Elect. 10 μ F 25WV	2
7-C14	EC320051	Elect. 10 μ F 16WV	2
7-C15	EC368335	Mylar 0.022 μ F(J) 50WV	2
7-C16	EC423562	VFM 470PF(J) 50WV	2
7-C17	EC450527	Elect. 4.7 μ F 25WV	2
7-C18	EC336216	VFM 330PF(J) 50WV	2
7-C19	EC480071	Elect. 22 μ F 16WV(noiseless)	2
7-C20	EC336216	VFM 330PF(J) 50WV	2
7-C21	EC476965	Elect. 47 μ F 25WV(noiseless)	2
7-C22	EC329771	Elect. 47 μ F 6.3WV	2
7-C23	EC379170	Mylar 0.1 μ F(J) 50WV	2
7-C24	EC379787	Mylar 0.0039 μ F(J) 50WV	2
7-C25	EC389485	Mylar 0.018 μ F(J) 50WV	2
7-C26	EC290520	VFM 100PF(J) 50WV	2
7-C27	EC329771	Elect. 47 μ F 6.3WV	2
7-C28	EC450527	Elect. 4.7 μ F 25WV	2
7-C29	EC220678	Elect. 47 μ F 25WV	2
7-C30	EC450527	Elect. 4.7 μ F 25WV	2
7-C31	EC329850	VFM 220PF(J) 50WV	2
7-C32	EC329771	Elect. 47 μ F 6.3WV	2
7-C33	EC220364	Elect. 100 μ F 6.3WV	2
7-C34	EC329850	VFM 220PF(J) 50WV	2
7-C35	EC350684	Elect. 22 μ F 25WV	2
7-C36	EC320051	Elect. 10 μ F 16WV	2
Resistor, Stopper Type			
7-R1	ER349907	Carbon RD1/4 33k(J)	2
7-R2	ER414303	Carbon RD1/4 220k(J) (noiseless)	2
7-R3	ER306360	Carbon RD1/4 6.8k(J)	2
7-R4	ER480060	Carbon RD1/4 33k(J) (noiseless)	2
7-R5	ER211465	Carbon RD1/4 1k(J)	2
7-R6	ER213030	Carbon RD1/4 5.6k(J)	2
7-R7	ER346601	Carbon RD1/4 47k(J)	2
7-R8	ER212883	Carbon RD1/4 4.7k(J)	2
7-R9	ER346601	Carbon RD1/4 47k(J)	2
7-R10	ER380711	Carbon RD1/4 220k(J)	2
7-R11	ER346994	Carbon RD1/4 18k(J)	2
7-R12	ER336442	Carbon RD1/4 10k(J)	2
7-R13	ER212264	Carbon RD1/4 22k(J)	2
7-R14	ER336442	Carbon RD1/4 10k(J)	2
7-R15	ER342933	Carbon RD1/4 27k(J)	2
7-R16	ER363644	Carbon RD1/4 560(J)	2
7-R17	ER213300	Carbon RD1/4 680(J)	2
7-R18	ER306843	Carbon RD1/4 1.2k(J)	2
7-R19	ER336442	Carbon RD1/4 10k(J)	2
7-R20	ER362485	Carbon RD1/4 330k(J)	2
7-R21	ER212681	Carbon RD1/4 330(J)	2
7-R22	ER347038	Carbon RD1/4 270(J)	2
7-R23	ER450011	Carbon RD1/4 120k(J)	2
7-R24	ER343078	Carbon RD1/4 2.7k(J)	4
7-R25,26	ER336442	Carbon RD1/4 10k(J)	2
7-R27	ER357570	Carbon RD1/4 150k(J)	2
7-R28	ER212883	Carbon RD1/4 4.7k(J)	2
7-R29	ER212477	Carbon RD1/4 3.3k(J)	4
7-R30,31	ER212264	Carbon RD1/4 22k(J)	2
7-R32	ER212883	Carbon RD1/4 4.7k(J)	2
7-R33	ER343078	Carbon RD1/4 2.7k(J)	2

When ordering parts, please describe Parts Number, Serial Number, and Model Number in detail.

FIG. 8 PHOTO OF
OSC. POWER P.C. BOARD (LE-5021)

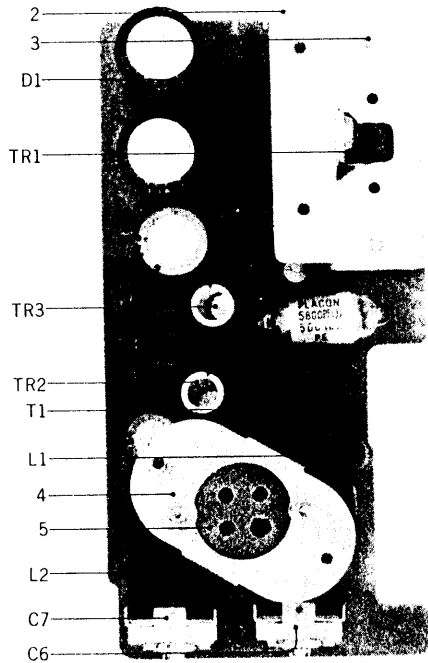

OSC. POWER P.C. BOARD (LE-5021) BLOCK

Symbol No.	Parts No.	Description	Q'ty
8-1x	BA480306	OSC. Power P.C. Board Comp. (LE-5021)	1
8-2	EZ480396	Heat-sink Plate	1
8-TR1	ET476886	Transistor 2SC1098(L,M)	1
8-3	ZW413155	Screw, binding head 3x6	3
8-TR2,3	ET304255	Transistor 2SC971(2,3) (red)	2
8-D1	ED329130	Silicon Diode 10DC-1(black)	1
8-D2	ED377234	Zener Diode 1S339-A	1
8-T1	EO383365	OSC. Coil 0T-204	1
8-L1,2	EO321254	Ferri Inductor FL7H 5.6MH(J)	2
8-4	EZ480418	Socket Table	1
8-5	EJ374027	4P Socket	1
8-6x	ZW447772	Tapping Screw 3x6(BR)	2
Capacitor, Vertical Type			
8-C1,2	EC337533	Elect. 220 μ F 50WV	2
8-C3	EC313121	Elect. 220 μ F 25WV	1
8-C4,5	EC350717	VFM 390PF(J) 50WV	2
8-C6,7	EC425250	Trimmer A-1P3-3 70PF	2
8-C8	EC383400	Plustic Film 5600PF(J) 500WV	1
8-C9	EC220678	Elect. 47 μ F 25WV	1
8-C10,11	EC250841	Mylar 0.01 μ F(J) 50WV	2
8-C12	EC350875	Mylar 0.001 μ F(J) 50WV	1
8-C13	EC250841	Mylar 0.01 μ F(J) 50WV	1
Resistor, Stopper Type			
8-R1	ER212883	Carbon RD1/4 4.7k(J)	1
8-R2	ER361642	Carbon RD1/4 47(J)	1
8-R3	ER413717	Wire-wound 3WL 18(J) (L type)	1
8-R4	ER398856	Metal Oxide Film 1W 100(K)	1
8-R5	ER212883	Carbon RD1/4 4.7k(J)	1
8-R6	ER304402	Carbon RD1/4 470(J)	1
8-R7,8	ER315944	Carbon RD1/4 3.3(J)	2

When ordering parts, please describe Parts Number, Serial Number, and Model Number in detail.

FIG. 9 PHOTO OF AMP. ASSEMBLY BLOCK

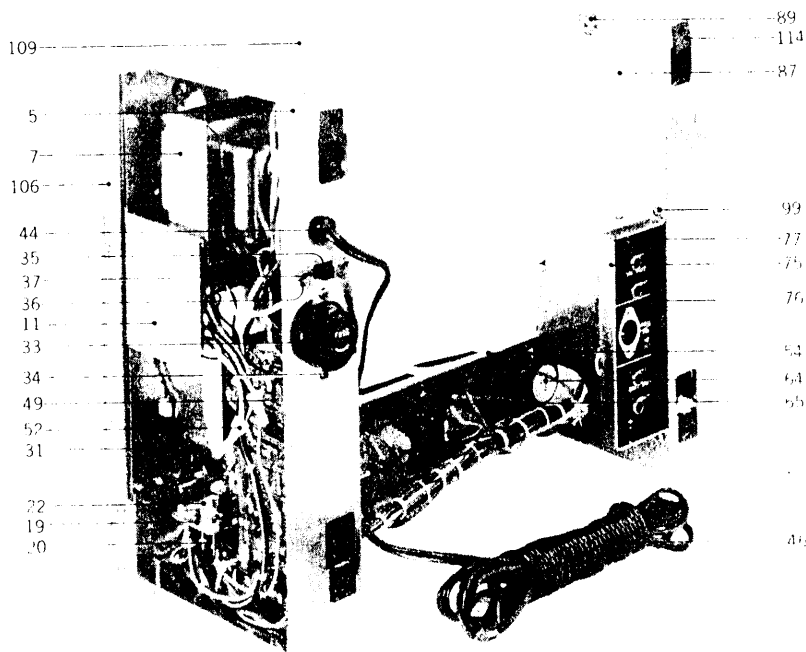
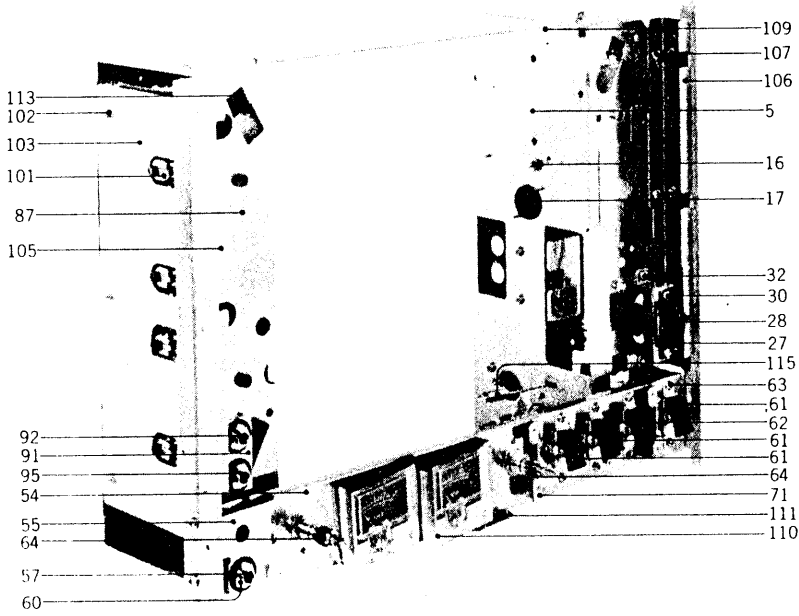

AMP. ASSEMBLY BLOCK

Ref. No.	Parts No.	Description	Schematic No.	Q'ty	Ref. No.	Parts No.	Description	Schematic No.	Q'ty
POWER SUPPLY FRAME BLOCK					9-60	ZW391680	E Jack Nut	7-1-20	1
9-1x	BZ480262	Power Supply Frame Block Comp. I.E.	I.E.	1	9-61	ES480543	Seesaw Switch 2 Circuit 2 Contactor	25-2-27	3
9-2x	BZ480273	Power Supply Frame Block Comp. (AAL) I.E.	I.E.	1	9-62	ES480554	Seesaw Switch 4 Contactor Earth type	26-2-26	1
9-3x	BZ480284	Power Supply Frame Block Comp. (CSA) I.E.	I.E.	1	9-63	ZW447772	Tapping Screw 3x6(BR)		8
9-4x	BZ480295	Power Supply Frame Block Comp. (CEE) I.E.	I.E.	1	9-64	EV480565	Double Volume DJ10A 50k Ax2	36-3-41	2
9-5	EZ479992	Power Supply Frame A	I.E.-5009	1	9-65	EA480576	Lamp P.C. Board	I.E.-5018	1
9-6x	EZ480003	Power Supply Frame B (AAL, CSA, CEE) I.E.-5009	I.E.-5009	1	9-66x	EL338196	No. 2 Lamp 8V 0.2A	28-2-9	1
9-7	BT480014	Power Trans. LET-1	38-4-162	1	9-67x	ER345712	Carbon RD1/4 22k(J)	35-9-5	1
9-8x	BT480025	Power Trans. LET-2 (AAL)	38-4-163	1	9-68x	ZW273778	M3 Earth Lug	24-1-1	4
9-9x	BT480036	Power Trans. LET-3 (CSA)	38-4-160	1	9-69x	EC379192	Mylar/C. 0.039µF(J) 50WV	24-1-1	2
9-10x	BT480047	Power Trans. LET-4 (CEE)	38-4-161	1	9-70x	EC379157	Mylar/C. 0.003µF(J) 50WV	24-1-1	2
9-11	EZ481296	Trans. Shield (LE)	I.E.-5034	1	9-71	EZ480587	Mech. Panel Table	I.E.-5016	2
9-12x	ZW323728	Screw, binding head 3x5		1	9-72x	ZW447772	Tapping Screw 3x6(BR)		8
9-13x	ZW273756	M3 Nut		1	JACK PLATE BLOCK				
9-14x	ZW434250	Screw, pan head 4x8, w/washer		2	9-73x	BZ480240	Jack Plate Block Comp.	I.E.-1	1
9-15x	ZW273914	M4 Spring Washer		2	9-74x	BZ486832	Jack Plate Block Comp. (CEE)	I.E.-1	1
9-16	ZW413188	M4 Nut	31-1-19	1	9-75	EZ480497	Jack Base	I.E.-5003	1
9-17	EJ277108	5P TV-Consent-Socket		1	9-76	EJ480508	Jack Plate, w/jack	I.E.-5004	1
9-18x	ZW447772	Tapping Screw 3x6(BR)		2	9-77	ZW201183	Screw, truss head 3x8 (black)		4
9-19	EZ480824	REC. Switch Holder	I.E.-5013	1	9-78x	ZW273756	M3 Nut		4
9-20	ES317744	Slide Switch SL-242B4V	25-3-28	1	9-79x	ER213873	Carbon/R. RD1/4 150k(J) (Insu. type)	35-9-5	2
9-21x	ZW461935	Screw, round head 2.6x4		2	9-80x	ER324685	Carbon/R. RD1/4 33k(J) (Insu. type)	35-9-5	2
9-22	GG227428	Spring B	900-116	1	9-81x	ER440921	Carbon/R. RD1/4 27k(J) (Insu. type) (CEE)	35-9-5	2
9-23x	ZW273881	M4 Earth Lug		2	9-82x	ER214290	Carbon/R. RD1/4 4.7k(J) (Insu. type)	35-9-5	2
9-24x	EZ493277	Rec. Switch Return Lever	I.E.-5036	1	9-83x	ER213647	Carbon/R. RD1/4 10k(J) (Insu. type) (CEE)	35-9-5	2
9-25x	ZW207314	Amp. Lever Set Screw	3A-737	2	9-84x	ER345712	Carbon/R. RD1/4 22k(J) (Insu. type)	35-9-5	4
9-26x	ZW447772	Tapping Screw 3x6(BR)		6	AMP. CHASSIS BLOCK				
9-27	EZ480846	Power Switch Table	I.E.-5011	1	9-85x	BZ480238	Amp. Chassis Block Comp.	I.E.-1	1
9-28	ES480857	Seesaw Switch JA-07 TV-3	25-2-29	1	9-86x	BZ486843	Amp. Chassis Block Comp. (CEE)	I.E.-1	1
9-29x	ES480868	Seesaw Switch JA-04 250V 5A (CEE)	25-2-31	1	9-87	EZ480598	Amp. Chassis	I.E.-5001	1
9-30	ZW323728	Screw, binding head 3x5		2	9-88x	EZ480600	P.C. Board Angle	I.E.-5006	1
9-31	ER376413	Spark Quencher U/L 0.033µ+ 120 500WV	41-1-37	1	9-89	EJ298607	4P Jack	31-1-10	1
9-32	ZW447772	Tapping Screw 3x6(BR)		2	9-90x	ZW273881	M4 Earth Lug	I.E.-5206	1
9-33	EJ233370	Socket (Volt. Selector) S-18010	40-2-3	1	9-91	EZ488957	Mic. Jack Table	31-2-23	2
9-34	ZW379405	Iso Screw, binding head 3x6		2	9-92	EJ374016	Mic. Jack 2PMJ1	I.D-520	2
9-35	ES375478	Slide Switch ESD-279DU	25-3-23	1	9-93x	EZ225180	Nylon Collar, Jack Washer (Fiber)D9.1x18x0.5t		2
9-36	EZ223817	Frequency Change Name Plate	3A-741	2	9-94x	ZW455275	E Jack Nut	7-1-20	2
9-37	ZW371856	Iso Screw, binding head 3x5		1	9-95	ZW391680	E Jack Nut		8
9-38x	EF277424	Fuse ST-4 0.8A	39-1-28	1	9-96x	ZW447772	Tapping Screw 3x6(BR)		1
9-39x	EF238634	Fuse 400MAT(T type) (CEE)		2	9-97x	BZ480240	Jack Plate Block Comp.	I.E.-1	1
9-40x	EF375647	Fuse 500MAT(T type) (CEE)		1	9-98x	BZ486832	Jack Plate Block Comp. (CEE)	I.E.-1	1
9-41x	EJ254970	Lug Plate KP1L1 (AAL)	33-3-3	1	9-99	ZW447772	Tapping Screw 3x6(BR)		4
9-42x	EJ480914	Fuse Holder (CEE)	101060	1	9-100x	MB259233	Wire Band C	3A-745	1
9-43x	EA480925	Fuse Terminal Plate 1 (CSA)	101061	1	AMP. ASSEMBLY BLOCK				
9-44	EZ382263	Strain Relief SR-4K-4	2-7-12	1	9-101	BA480251	Pre-Amp. P.C. Board Comp. (LE-5022)		1
9-45x	EZ246936	Strain Relief SR-6W-1 (3 core)	2-7-8	1	9-102	EZ314504	Shield Plate Prop	MR-525	3
9-46	EZ374894	U/L AC Cord 3M	26-3-19	1	9-103	EZ480756	Shield Plate	I.E.-5008	1
9-47x	EZ315448	Australia Cord	26-3-11	1	9-104x	ZW273756	M3 Nut		3
9-48x	EZ354240	Power Cord ER0150 (CEE)		1	9-105	EZ480982	Sash Angle A (left)	I.E.-6008	1
9-49	BA480306	OSC. Power P.C. Board Comp. (LE-5021)		1	9-106	EZ480993	Sash Angle B (right)	I.E.-6008	1
9-50x	ZW413223	Screw, binding head 3x5, w/washer		4	9-107	ZW447772	Tapping Screw 3x6(BR)		14
9-51x	MB259233	Wire Band C	3A-745	1	9-108x	EZ480767	LE Pre-Amp. Harness	26-6-95	1
9-52	EJ205975	Cramp Terminal 1-SD	32-1-7	2	9-109	EZ225303	Upper Angle	I.D-508	1
CONTROL CHASSIS BLOCK					9-110	EM480778	VU Meter B1914R	46-1-57	2
9-53x	BZ480317	Control Chassis Block Comp.	I.E.	1	9-111	EZ480780	Lamp Mask	I.E.-5023	1
9-54	EZ480521	Control Chassis	I.E.-5015	1	9-112x	EZ486865	Lamp Mask B	I.E.-5035	2
9-55	EZ480532	Head Phone Jack Plate	I.E.-5017	1	9-113	ZW290248	'U' type Speed Nut M4 #1 (small)	6-3-1	4
9-56x	ZW447772	Tapping Screw 3x6(BR)		2	9-114	ZW290250	'U' type Speed Nut M4 #1 (large)	6-3-2	6
9-57	EJ437321	3-P Molded-Jack 3PMJ1P	31-2-38	1	9-115	SL493042	Rec. Wire B	I.E.-6028	1
9-58	ZW272722	M9 Toothed Washer D9.3x13x0.5t		1					
9-59x	ZW454860	Washer (Fiber)D9.2x15x0.5t		1					

When ordering parts, please describe Parts Number, Serial Number, and Model Number in detail.

FIG. 10. PHOTO OF FINAL ASSEMBLY BLOCK



FINAL ASSEMBLY BLOCK

Ref. No.	Parts No.	Description	Schematic No.	Q'ty	Ref. No.	Parts No.	Description	Schematic No.	Q'ty
MECH. PANEL BLOCK					10-23x	ZW413155	Screw, binding head 3x6		2
10-1x	BZ480172	Mech. Panel Block Comp.	1.E	1	10-24	SP481004	Sash	1.E-6009	2
10-2x	BZ480183	Mech. Panel Block Comp. (CSA,AAL)	1.E	1	10-25x	ZW424124	Screw, countersunk head 3x5		6
10-3x	BZ486854	Mech. Panel Block Comp. (CEE)	1.E	1	10-26	SP481015	Amp. Panel	1.E-6006	1
10-4	SP480723	Mech. Panel A	1.E-6001	1	10-27	EZ426780	Illumination Escutcheon(red)	61-5023	1
10-5x	SP480734	Mech. Panel B (CSA,AAL)	1.E-6001	1	10-28	ZW414336	Screw, truss head 3x6. w/washer (black)		2
10-6x	SP485730	Mech. Panel C (CEE)	1.E-6001	1	10-29	SK475097	Knob A	1.E-6012	2
10-7	SM480745	Reel Table Ring	1.E-6003	2	10-30	SK475121	Knob B	1.E-6015	2
10-8	SZ276816	ST-1 Capstan Rest	100180	1	10-31x	SC481026	Head Cover Comp.	1.E-6025	1
10-9x	ZW424124	Screw, countersunk head 3x5		1	10-32	SC481037	Head Cover	1.E-6004	1
10-10	SZ330895	MR Counter Escutcheon	MR-646	1	10-33	SM481048	Name Plate 4000DS	1.E-6005	1
CASE BLOCK					10-34x	ZW312221	Screw, truss head 3x15(black)		2
10-11	BC480161	Case Block Comp.	1.E-1	1	10-35	SK485651	Head Change Knob C	1.E-6027	1
10-12	SZ482152	LE Case Foot	1.E-4002	2	10-36x	ZW434160	Set Screw, hexagon socket 3x3(cup)		1
10-13x	ZW419646	Washer (SPC)D4.5x9.8x0.5t		4	10-37	SK425158	Pinch Roller Cap	MS-6020	1
10-14x	ZW413188	M4 Nut		4	10-38x	ZW481072	Washer (SUP)D4x10x0.25t		1
10-15x	SZ382217	Fan Grill	RD-A 402	1	10-39	SK476684	Mech. Knob	1.E-6018	2
10-16x	ZW324448	Tapping Screw #1 3x10(truss)		3	10-40x	ZW253405	Mech. Knob Screw	7-1-46	2
10-17	SZ480712	Dust Cover Pin	1.E-6024	2	10-41x	ZW260166	Washer (Nylon) D6.2x13x0.125t		2
FINAL ASSEMBLY BLOCK					10-42	SK314100	Pause Knob B	MR-612	1
10-18x	ZW200643	Tapping Screw #1 4x25(truss)		2	10-43x	ZW433001	Set Screw, hexagon socket 3x5(cup)		1
10-19x	SZ377190	LM Rubber Foot	1.M-404	4	10-44x	EF460146	Fuse ST-4 0.4A	39-1-28	1
10-20x	ZW419646	Washer (SPC)D4.5x9.8x0.5t		4	10-45	MP204794	Pinch Roller #3	3A-348	1
10-21x	ZW434283	Tapping Screw #1 4x30(truss)		4	10-46x	EF277424	Fuse ST-4 0.8A	39-1-28	1
10-22	ZW467853	Screw, truss head 3x6, w/washer		4	10-47x	EF460146	Fuse ST-4 0.4A (CEE)	39-1-28	1

When ordering parts, please describe Parts Number, Serial Number, and Model Number in detail.

INDEX

Parts No.	Ref. No. & Symbol No.	Parts No.	Ref. No. & Symbol No.	Parts No.	Ref. No. & Symbol No.	Parts No.	Ref. No. & Symbol No.	Parts No.	Ref. No. & Symbol No.
BA480251	7-1x	EC450527	7-C30	ER413717	8-R3	MI231423	6-120	MZ253653	6-52
BA480251	9-101	EC476965	7-C5	ER414303	7-R2	ML217451	4-15	MZ253956	3-9x
BA480306	8-1x	EC476965	7-C21	ER440921	9-81x	ML217934	6-64	MZ254160	3-14
BA480306	9-49	EC480071	7-CJ9	ER450011	7-R23	ML226146	5-36	MZ254182	3-15
BC252977	4-13x	EC493323	7-C4	ER480060	7-R4	ML226258	6-125	MZ254351	3-13
BC480161	10-11	ED219464	7-D1	ES250007	6-26	ML243540	6-89	MZ256814	6-57x
BF205075	4-1x	ED329130	8-D1	ES257668	1-27	ML251932	6-65	MZ257073	6-18
BH480363	1-1x	ED377234	8-D2	ES316934	5-3	ML256983	6-74	MZ257591	3-5x
BL203523	4-14x	EF238634	9-39x	ES317744	9-20	ML257040	6-80	MZ258581	5-28
BL204658	6-112	EF277424	9-38x	ES369865	5-4	ML257128	5-19	MZ260662	6-77
BM271800	3-1x	EF277424	10-46x	ES375478	9-35	ML257163	6-85	MZ271776	6-7
BR205020	2-1x	EF375647	9-40x	ES480543	9-61	ML257196	6-69	MZ273295	6-8
BR205244	2-2x	EF460146	10-44x	ES480554	9-62	ML270685	6-53	MZ292364	3-20
BS480352	5-1x	EF460146	10-47x	ES480857	9-28	ML295727	6-83	MZ293567	6-61
BT247746	7-T1	EI412413	7-IC1,2	ES480868	9-29x	ML300161	6-68	MZ293578	6-62
BT480014	9-7	EJ205975	6-124x	ET234854	7-TR3,4	ML308564	6-34x	MZ296267	4-6
BT480025	9-8x	EJ205975	9-52	ET304255	8-TR2,3	ML309093	6-49	MZ312524	6-23
BT480036	9-9x	EJ233370	9-33	ET352146	7-TR1	ML475920	6-46	MZ312535	6-24
BT480047	9-10x	EJ254970	9-41x	ET398845	7-TR2	ML479957	6-97	MZ316901	5-2
BZ400948	6-1x	EJ255115	1-30	ET476886	8-TR1	ML488744	5-33	MZ316945	5-5x
BZ480172	10-1x	EJ276963	1-33	EV337577	7-VR1	MP204794	6-115x	MZ316956	5-7x
BZ480183	10-2x	EJ277108	9-17	EV337588	7-VR2	MP204794	10-45	MZ316956	6-130
BZ480238	9-85x	EJ297843	1-32	EV480565	9-64	MR251460	2-5	MZ317068	5-30
BZ480240	9-73x	EJ298607	9-89	EZ223817	9-36	MR252044	2-28	MZ327341	5-10
BZ480240	9-97x	EJ317125	6-122x	EZ225180	9-93x	MR252055	2-30	MZ327352	5-12
BZ480262	9-1x	EJ374016	9-92	EZ225303	9-109	MR252066	2-11	MZ373961	6-27
BZ480273	9-2x	EJ374027	8-5	EZ246936	9-45x	MR254496	3-17	MZ395144	3-2
BZ480284	9-3x	EJ437321	9-57	EZ314504	9-102	MR256083	2-26	MZ395166	5-7
BZ480295	9-4x	EJ480508	9-76	EZ315448	9-47x	MR269728	5-34	MZ396393	6-123x
BZ480317	9-53x	EJ480914	9-42x	EZ335204	3-10x	MR269763	6-93	MZ410938	6-16x
BZ486832	9-7x	EL338196	9-66x	EZ354240	9-48x	MR300644	3-18	MZ446635	4-7
BZ486832	9-98x	EM480778	9-110	EZ374894	9-46	MS205558	6-54	MZ452496	6-36x
BZ486843	9-86x	EO243977	7-L1	EZ382263	9-44	MS217192	6-94	SB425777	6-126
BZ486854	10-3x	EO244001	7-L2	EZ426780	10-27	MS243404	6-90	SB488698	6-108
EA480576	9-65	EO321254	8-L1,2	EZ479992	9-5	MS244708	4-3	SC481026	10-31x
EA480925	9-43x	EO383365	8-T1	EZ480003	9-6x	MS245463	6-21	SC481037	10-32
EC220364	7-C3	EO390622	1-31	EZ480396	8-2	MS257051	6-10	SK314100	10-42
EC220364	7-C9	ER211465	7-R5	EZ480418	8-4	MS260515	6-48	SK425158	10-37
EC220364	7-C11	ER212264	7-R13	EZ480497	9-75	MT222366	2-6	SK475097	10-29
EC220364	7-C33	ER212264	7-R30,31	EZ480521	9-54	MT228587	2-38	SK475121	10-30
EC220678	7-C6	ER212477	7-R29	EZ480532	9-55	MT235596	2-40	SK476684	10-39
EC220678	7-C29	ER212681	7-R21	EZ480587	9-71	MT252101	2-12x	SK485651	10-35
EC220678	8-C9	ER212883	7-R8	EZ480598	9-87	MT252112	2-4x	SL493042	9-115
EC220994	7-C13	ER212883	7-R28	EZ480600	9-88x	MT252123	2-31x	SM480745	10-7
EC250841	8-C10,11	ER212883	7-R32	EZ480756	9-103	MT255870	2-10	SM481048	10-33
EC250841	8-C13	ER212883	8-R1	EZ480767	9-108x	MT255870	2-18	SP480723	10-4
EC273442	3-27x	ER212883	8-R5	EZ480780	9-111	MT255971	2-14	SP480734	10-5x
EC290520	7-C2	ER213030	7-R6	EZ480824	9-19	MT255982	2-32x	SP481004	10-24
EC290520	7-C7	ER213300	7-R17	EZ480846	9-27	MT255993	2-23	SP481015	10-26
EC290520	7-C26	ER213647	9-83x	EZ480982	9-105	MT256140	2-3	SP485730	10-6x
EC313121	8-C3	ER213873	9-79x	EZ480993	9-106	MT256228	2-21	SZ247015	1-6
EC320051	7-C8	ER214290	9-82x	EZ481296	9-11	MT256228	2-33x	SZ276816	10-8
EC320051	7-C14	ER304402	8-R6	EZ486865	9-112x	MT480971	2-41	SZ330895	10-10
EC320051	7-C36	ER306360	7-R3	EZ488957	9-91	MV248117	6-5	SZ377190	10-19x
EC329771	7-C22	ER306843	7-R18	EZ493277	9-24x	MV269965	3-6x	SZ382217	10-15x
EC329771	7-C27	ER315944	8-R7,8	HE384693	1-24	MV269965	4-35	SZ465377	6-3
EC329771	7-C32	ER324685	9-80x	HL223503	1-37	MV270066	5-16x	SZ465388	6-6
EC329850	7-C31	ER336442	7-R12	HL223536	1-42	MV270066	6-133	SZ480712	10-17
EC329850	7-C34	ER336442	7-R14	HL312941	1-40	MY270055	4-11	SZ482152	10-12
EC336216	7-C18	ER336442	7-R19	HP375131	1-13	MZ204311	6-2	UC254250	3-3
EC336216	7-C20	ER336442	7-R25,26	HR475446	1-19	MZ205817	6-28	ZG206144	1-12
EC337533	8-C1,2	ER339805	3-28	HZ224751	6-12	MZ217113	6-104	ZG206144	1-18
EC350684	7-C35	ER342933	7-R15	HZ274162	1-3	MZ217203	5-20	ZG208091	6-59
EC350717	8-C4,5	ER343078	7-R24	HZ312895	1-26	MZ217203	6-50	ZG217337	4-17
EC350875	8-C12	ER343078	7-R33	HZ393974	1-14x	MZ217203	6-81	ZG217394	4-19x
EC368335	7-C12	ER345712	9-67x	HZ393974	1-20x	MZ217293	5-17x	ZG217394	6-129
EC368335	7-C15	ER345712	9-84x	HZ480420	1-10	MZ217293	6-131	ZG217866	6-101
EC379157	9-70x	ER346601	7-R7	HZ480431	1-16	MZ217686	5-32	ZG227417	6-95
EC379170	7-C23	ER346601	7-R9	HZ480442	1-22	MZ217686	6-103	ZG227428	9-22
EC379192	9-69x	ER346994	7-R11	HZ480475	1-35	MZ217708	6-55	ZG227441	6-76
EC379787	7-C24	ER347038	7-R22	HZ490296	1-2	MZ217855	6-99	ZG227452	6-75
EC383400	8-C8	ER349907	7-R1	MB254158	3-21	MZ225720	5-26	ZG227485	5-40
EC389485	7-C25	ER357570	7-R27	MB256601	4-22	MZ244113	4-9x	ZG227496	2-36
EC410016	3-26	ER361642	8-R2	MB259233	9-51x	MZ244473	4-2	ZG227520	2-29x
EC423562	7-C16	ER362485	7-R20	MB259233	9-100x	MZ244530	4-30	ZG227531	2-7
EC425250	8-C6,7	ER363644	7-R16	MB406168	6-111x	MZ244620	4-24	ZG227564	5-38
EC432810	7-C1	ER376413	9-31	MC479968	6-110	MZ244631	4-23	ZG227575	6-56
EC446297	7-C10	ER376435	6-33x	MH258816	6-15x	MZ245485	6-22x	ZG227575	6-88
EC450527	7-C17	ER380711	7-R10	MH312827	1-8	MZ248354	4-16	ZG227586	5-11
EC450527	7-C28	ER398856	8-R4	MI204423	6-116	MZ253113	4-10	ZG257095	6-20

INDEX

Parts No.	Ref. No. & Symbol No.	Parts No.	Ref. No. & Symbol No.	Parts No.	Ref. No. & Symbol No.	Parts No.	Ref. No. & Symbol No.
ZG270358	6-84	ZW290283	6-72	ZW434160	2-39		
ZG290384	6-73	ZW290283	6-82x	ZW434160	10-36x		
ZG312748	6-60	ZW290283	6-119	ZW434171	2-27		
ZG312928	1-38	ZW290294	6-114	ZW434193	5-15x		
ZG469427	6-51	ZW293027	4-12	ZW434215	5-14x		
ZW200474	3-25	ZW300655	3-19	ZW434250	9-14x		
ZW200643	10-18x	ZW312221	10-34x	ZW434283	10-21x		
ZW201183	9-77	ZW312693	2-35	ZW447208	4-5		
ZW201767	6-70x	ZW314728	6-127x	ZW447772	8-6x		
ZW201778	5-13	ZW318532	6-109x	ZW447772	9-18x		
ZW202105	6-58x	ZW322525	6-113x	ZW447772	9-26x		
ZW202138	5-6x	ZW323728	1-23	ZW447772	9-32		
ZW203253	5-37	ZW323728	1-44	ZW447772	9-56x		
ZW207314	9-25x	ZW323728	6-47x	ZW447772	9-63		
ZW217102	6-105	ZW323728	6-78	ZW447772	9-72x		
ZW217877	5-22	ZW323728	6-100	ZW447772	9-96x		
ZW217877	6-98	ZW323728	9-12x	ZW447772	9-99		
ZW223233	6-87	ZW323728	9-30	ZW447772	9-107		
ZW231693	2-16	ZW324448	10-16x	ZW454860	9-59x		
ZW231794	4-28x	ZW330412	6-38x	ZW455275	9-94x		
ZW231805	6-4	ZW330423	6-39x	ZW461305	2-42		
ZW235585	4-31	ZW330434	6-40x	ZW461935	9-21x		
ZW244574	4-27	ZW330445	6-41x	ZW462835	6-44x		
ZW244710	4-8	ZW336846	1-39	ZW462846	6-45x		
ZW253405	10-40x	ZW371856	9-37	ZW464714	1-11		
ZW254621	3-12	ZW373577	4-4	ZW464714	1-17		
ZW259795	6-102x	ZW376391	6-96x	ZW467853	10-22		
ZW259918	6-71	ZW376391	6-118x	ZW477876	1-15		
ZW259942	6-66x	ZW379405	9-34	ZW477876	1-21		
ZW259975	6-91x	ZW384131	3-4x	ZW477876	1-25		
ZW260021	2-34	ZW391680	9-60	ZW480622	1-41		
ZW260054	2-8	ZW391680	9-95	ZW481072	10-38x		
ZW260054	4-20x	ZW393232	4-33				
ZW260065	2-9x	ZW393726	6-25				
ZW260065	2-20	ZW413155	1-43				
ZW260065	2-24	ZW413155	8-3				
ZW260076	2-19	ZW413155	10-23x				
ZW260076	6-117x	ZW413188	3-23x				
ZW260098	2-13x	ZW413188	6-17x				
ZW260122	6-121	ZW413188	6-35x				
ZW260133	5-9x	ZW413188	6-92				
ZW260133	5-29	ZW413188	6-107x				
ZW260166	5-23x	ZW413188	9-16				
ZW260166	6-86	ZW413188	10-14x				
ZW260166	10-41x	ZW413201	4-18				
ZW260201	2-15	ZW413201	5-8x				
ZW260201	2-17	ZW413201	5-27				
ZW260201	2-37	ZW413201	5-31				
ZW260245	2-22	ZW413201	6-13x				
ZW260245	3-8x	ZW413201	6-37x				
ZW270000	2-25	ZW413223	1-36				
ZW272395	3-24	ZW413223	3-29				
ZW272722	9-58x	ZW413223	6-63x				
ZW273723	1-28	ZW413223	9-50x				
ZW273734	1-29	ZW413245	6-106				
ZW273756	1-5	ZW413267	6-11x				
ZW273756	6-31x	ZW413267	6-43x				
ZW273756	9-13x	ZW413280	4-34				
ZW273756	9-78x	ZW413998	4-32				
ZW273756	9-104x	ZW414033	6-9x				
ZW273767	6-79	ZW414044	6-14x				
ZW273778	1-45	ZW414055	6-29x				
ZW273778	9-68x	ZW414066	6-30				
ZW273802	1-4	ZW414336	10-28				
ZW273802	6-32x	ZW416687	5-18x				
ZW273881	6-42x	ZM416687	6-132				
ZW273881	9-23x	ZW417025	1-7				
ZW273881	9-90x	ZW417025	1-9				
ZW273892	5-24x	ZW417025	1-34				
ZW273914	4-26x	ZW417150	6-19x				
ZW273914	9-15x	ZW419646	10-13x				
ZW273960	5-25	ZW419646	10-20x				
ZW274048	4-29	ZW427037	3-11				
ZW290248	9-113	ZW424056	3-16				
ZW290250	9-114	ZW424056	3-22				
ZW290283	4-21x	ZW424056	4-25x				
ZW290283	5-21x	ZW424124	10-9x				
ZW290283	5-35x	ZW424124	10-25x				
ZW290283	5-39	ZW425788	6-128x				
ZW290283	6-67	ZW433001	10-43x				

SECTION 3
SCHEMATIC DIAGRAM

4000DS SCHEMATIC DIAGRAM

SERVICE MANUAL

PARTS LIST

AKAI STEREO TAPE DECK

MODEL **4000DS Mk-II**

THIS MANUAL MUST BE USED AS A SET TOGETHER WITH
SEPARATELY PUBLISHED 4000DS SERVICE MANUAL AND PARTS
LIST.

4000DS Mk-II

SECTION 1 Except for the parts which have been changed as per List 1 below, the composite parts of Model 4000DS Mk-II are identical to those of Model 4000DS. Therefore, for general repairs and adjustments, etc., please refer to 4000DS Service Manual, and GENERAL OPERATING PRINCIPLES AND ADJUSTMENTS.

I. SPECIFICATIONS

An asterisk next to a figure indicates the minimum guaranteed performance.

TAPE SPEED		7-1/2 and 3-3/4 ips $\pm 2\%$ *7-1/2 and 3-3/4 ips (19 and 9.5 cm/sec) $\pm 3\%$ (7-1/2 ips 1,000 Hz speed standard tape playback)
WOW AND FLUTTER		Less than 0.12% WRMS at 7-1/2 ips *Less than 0.22% RMS at 7-1/2 ips Less than 0.15% WRMS at 3-3/4 ips *Less than 0.30% RMS at 3-3/4 ips (3,000 Hz wow standard tape playback)
TOTAL WOW AND FLUTTER		Less than 0.28% at 7-1/2 and 3-3/4 ips
FREQUENCY RESPONSE	LOW NOISE TAPE	30 to 23,000 Hz ± 3 dB at 7-1/2 ips *40 to 20,000 Hz ± 3 dB at 7-1/2 ips 30 to 16,000 Hz ± 3 dB at 3-3/4 ips *40 to 15,000 Hz ± 3 dB at 3-3/4 ips
	WIDE RANGE TAPE	40 to 21,000 Hz ± 3 dB at 7-1/2 ips 40 to 16,000 Hz ± 3 dB at 3-3/4 ips (Adjust 2 kHz and 20 kHz to same response. -20 VU recording, using a Scotch #211 tape.)
TOTAL DISTORTION FACTOR		Less than 1.0% at 7-1/2 and 3-3/4 ips *Less than 2.0% at 7-1/2 and 3-3/4 ips (Scotch #211 tape, 1,000 Hz 0 VU recording and playback)
LINE OUTPUT		0.775V (0 dBm ± 1 dB) (7-1/2 ips 250 Hz 0 VU standard tape playback)
RECORDING/PLAYBACK LEVEL		0.775V (0 dBm ± 1.5 dB) (Scotch #211 tape 1,000 Hz 0 VU recording/playback)
SIGNAL TO NOISE RATIO		Better than 50 dB at 7-1/2 ips Better than 48 dB at 3-3/4 ips
TOTAL SIGNAL TO NOISE RATIO		Better than 44 dB
CROSS TALK	STEREO	Better than 45 dB
	MONAURAL	Better than 60 dB
ERASE RATIO		Better than 70 dB
BIAS FREQUENCY		105 kHz $\pm 5\%$
INPUT SENSITIVITY/IMPEDANCE	MIC	More than 0.8 mV/30 k ohm
	LINE	More than 70 mV/200 k ohm
	DIN	More than 7 mV/15 k ohm
BIAS LEAK		Less than -30 VU
HIGH FREQUENCY DEVIATION		Within 2 dB (Playback of 3-3/4 ips 8,000 Hz Angle adjustment tape at 7-1/2 ips)
RECORDING CAPACITY		90 minutes stereo recording using an 1,800 ft tape at 7-1/2 ips)
F.FWD AND RWD TIME		4 min and 40 sec at 50 Hz (using 1,800 ft tape)
MOTOR		4-pole induction motor Type: SSM-1 Revolutions: 1,500/1,800 rpm 50/60 Hz
HEAD	ERASE HEAD	Type: E4-200 Gap: 0.6 mm Impedance: 200 ohm $\pm 5\%$ at 100 kHz DC Resistance: 2 ohm
	RECORDING HEAD	Type: R4-150 Gap: 8 micron Impedance: 95 ohm $\pm 15\%$ at 1 kHz DC Resistance: 14.7 ohm
	PLAYBACK HEAD	Type: P4-150 Gap: 1 micron Impedance: 1,050 ohm $\pm 20\%$ at 1 kHz DC Resistance: 94.5 ohm
TRANSISTOR		2SC4581G(C) . . . 4 2SC1312R(F)(G) . . . 2 2SC4581G(D) . . . 2 2SC1647(R)(S)(E) . . . 4 2SC1096(K)(L) . . . 1 2SC1648(R)(S)(E) . . . 4 2SC1247A(B)(V) . . . 2
DIODE		1N34A . . . 2 10D05 . . . 2
ZENER DIODE		WZ240 . . . 1

POWER REQUIREMENTS	JPN CSA CEE, VDE BSI UNIVERSAL	100V AC 50/60 Hz 120V AC 60 Hz 220V AC 50 Hz 240V AC 50 Hz 110 to 240V AC 50/60 Hz
POWER CONSUMPTION		40W
DIMENSIONS		407(W) x 314(H) x 196(D) mm (16.2" x 12.6" x 7.8")
WEIGHT		11.1 kg (24.4 lbs.)

NOTE: Specifications subject to change without notice.

1. PRE AMP. P.C. BOARD LE-5623

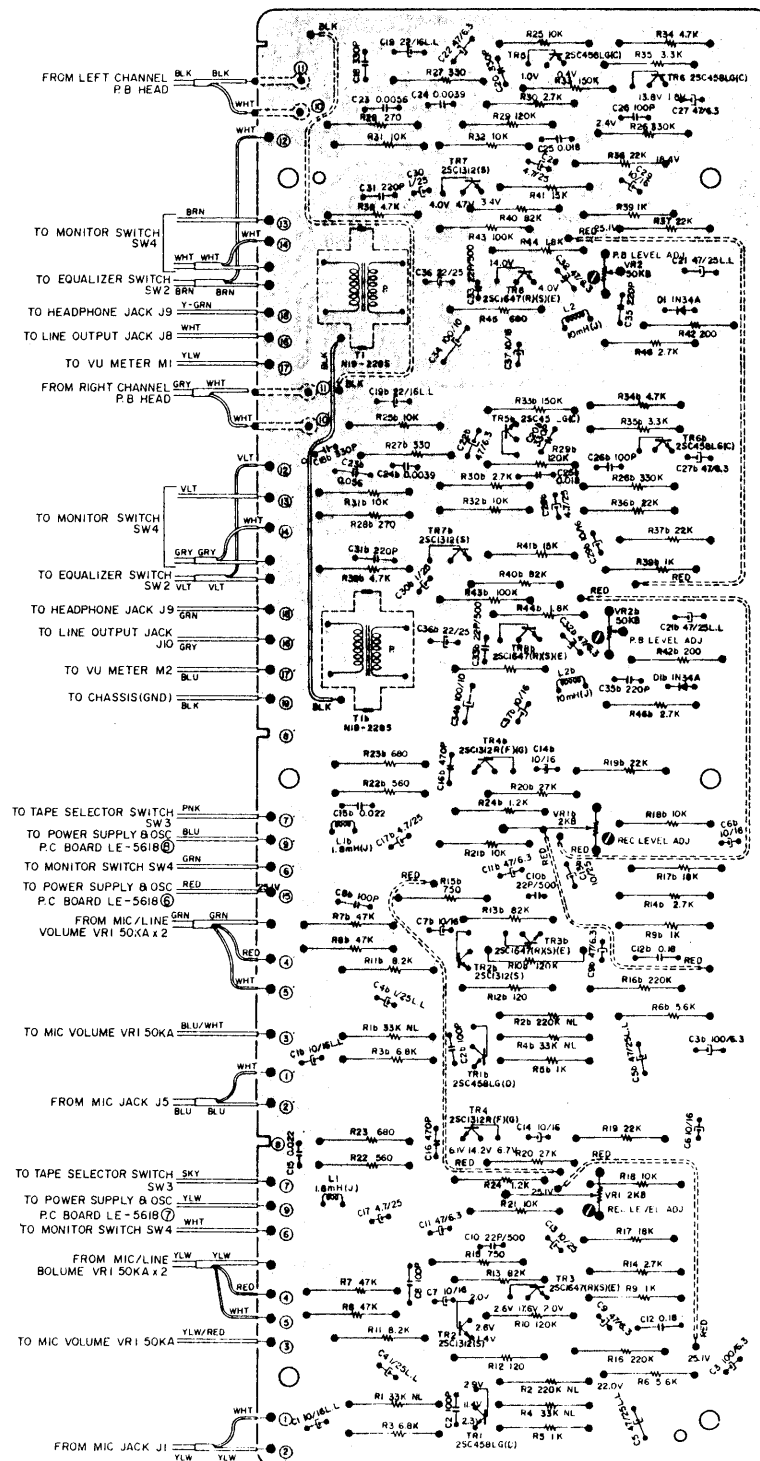

2. EQUALIZER P.C. BOARD LE-5617

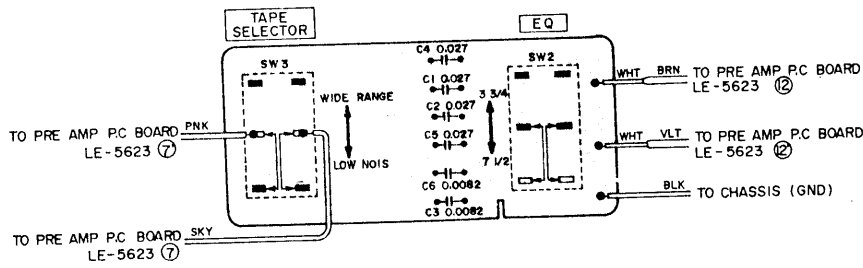

3. SWITCH P.C. BOARD LE-5616

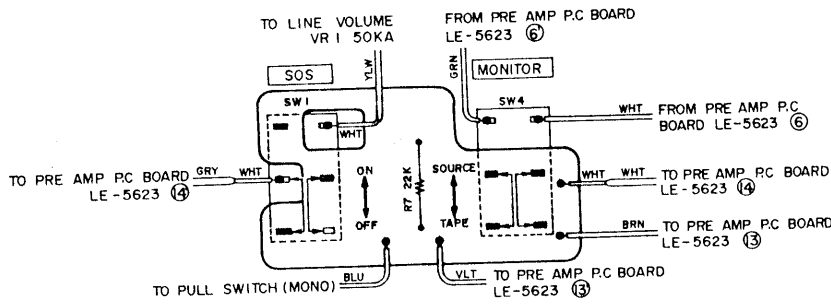

4. POWER SUPPLY & OSC P.C. BOARD LE-5618

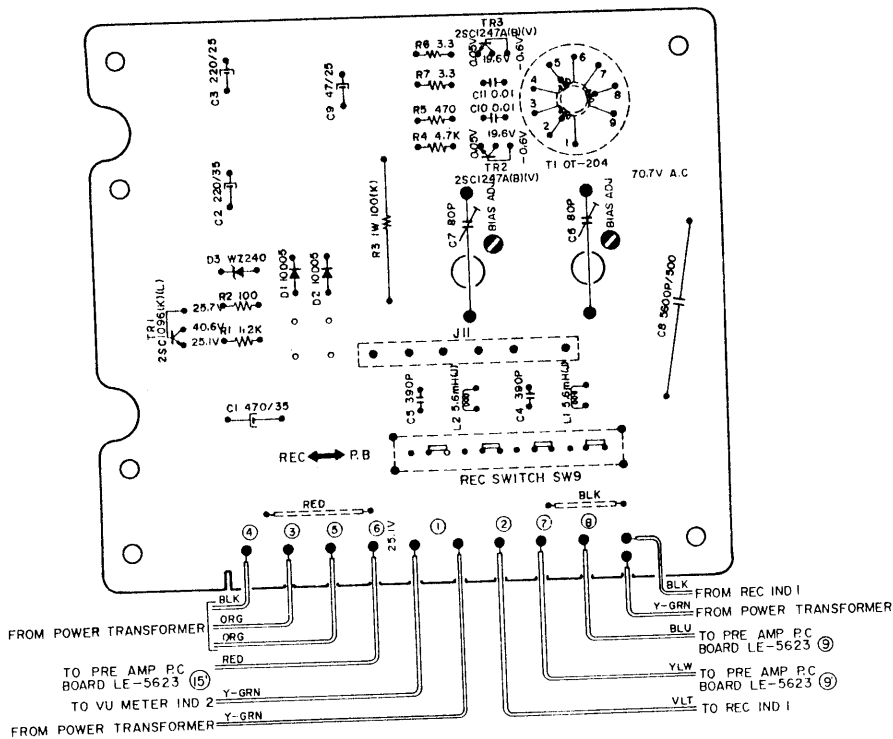

5. JACK PLATE P.C. BOARD LE-5626

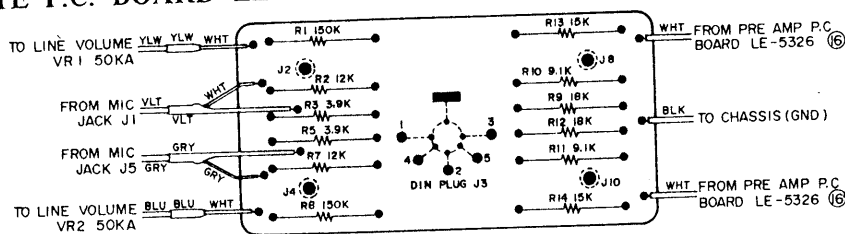

400BDS Mk-II

SECTION 2 The composite parts of Model 4000DS-Mk-II, except for those which have been changes as per the list below, are identical to those of Model 4000DS. Therefore, when ordering parts for this tape deck, please utilize Model 4000DS Parts List.

Ref. No.	Parts No.	Description	Schematic No.	Q'ty	Ref. No.	Parts No.	Description	Schematic No.	Q'ty
1-1x	BH624385	Head Block Comp.	1.E-6	1	9-126x	EF238634	Fuse 400MAT (T Type) (CEE)		3
1-46x	HZ393974	I-MK Head Terminal Plate	RC-89	1				39-1-50	3
2-1x	BR589206	Supply Reel Table Block Comp.	LE-3,4,6	1	9-127x	EF563681	Fuse 1A 250V (JPN)		1
2-2x	BR657180	Take-up Reel Table Block Comp.	LE-3,4,6	1	9-128x	ZW273881	Earth Lug M4 (CEE)	LE-5312	1
2-7	ZG227553	Spring G-2 (L)	900-230	1	9-129x	EA615655	Fuse P.C. Board LE	31-2-57	1
2-21	MT292386	Reel Metal Mt. Parts, XR, w/metal	XR-191	1	9-130x	EJ624036	2-through Jack	31-2-17	1
2-27	ZS434171	Set Screw, hexagon Socket 4x7 (cup/p.)		1	9-131x	EJ376604	Mic. Jack 3PMJ1	LE-5603	1
2-36	ZG434092	Spring F4-B	1.F-2004	1	9-132x	MZ628290	REC. Slider	CC-1119	1
2-38	MT228598	Set Sleeve B	CD-66	1	9-133x	ZG456186	Lock Lever Spring	LE-5617	1
2-39	ZS434160	Set Screw, hexagon Socket 3x3 (cup/p.)		1	9-134x	BA628356	EQ. P.C. Board		1
2-41	MT368684	Reel Table Disk A	XR-101	1	9-135x	ES603696	Seesaw SW. 2C-2P (w/earth)	25-2-36	1
2-43x	MT255420	Reel Retainer	3R-102	1	9-136x	ES603707	Seesaw SW. 2C-2P (w/earth)	25-2-37	1
2-44x	ZG255633	Reel Spring	3R-109	1	9-137x	ES603707	Seesaw SW. 2C-2P (w/earth)	25-2-37	2
2-45x	MT255565	Reel Shaft Ring	XR-177	1	9-138x	EA628367	SW. P.C. Board	LE-5616	1
2-46x	ZW270088	'E' Ring 1.9M	6-1-9	1	9-139x	EV480565	Double Vol. DJ10A 50KAx2	36-3-41	1
3-1x	BM624407	Motor Block Comp.	1.E-6	1	9-140x	EV603134	Double Vol. (w/sw.) V24L5DS A50Kx2	36-12-7	1
6-1x	BZ636996	Tape Guide Block Comp.	1.E-6, 1722W/L	1	9-141x	EJ603145	Lamp Terminal Plate B	33-2-37	2
6-5	MV447491	Bearing SSR-1950ZZD52		1	9-142x	EL591186	Lamp 6.3V 150MA	28-2-35	2
6-108	SB258478	REC. Button (Red)	900-167	1	9-143x	EM480778	VU Meter B-1914R	46-1-57	2
6-110	MC479968	Counter MP-491-28	9-1-23	1	9-144x	SE486865	Lamp Mask B	LE-5035	2
6-116	MI628244	Idler Wheel C	1.E-2604	1	10-1x	BD588745	Mech. Panel Block Comp.	LE-3,6	1
6-126	SB485741	Start Button C	MS-1002	1	10-3x	BD624240	Mech. Panel Block Comp. (CEE)	LE-6	1
7-1x	BA624418	Pre-Amp. P.C. Board Comp. (LE-5623A)	1.E-6	1	10-4	SP578204	Mech. Panel A-1	LE-6001	1
7-TR2	ET623722	Transistor 2SC1648(R)(S)(E)	45-1-178	2	10-10	SE330895	Counter Escutcheon, MR	MR-646	1
7-TR3	ET623733	Transistor 2SC1647(R)(S)(E)	45-1-179	2	10-11	BC624238	Case Block Comp.	LE-6	1
7-TR4	ET539987	Transistor 2SC1312(F)(G)	45-1-133	2	10-32	SC605823	Head Cover	LE-6030	1
7-TR7	ET623722	Transistor 2SC1648(R)(S)(E)	45-1-178	2	10-35	SK485651	Head Change Knob C	LE-6027	1
7-TR8	ET623733	Transistor 2SC1647(R)(S)(E)	45-1-179	2	10-48x	SP485730	Mech. Panel C (CEE)	LE-6001	1
7-L1	EO380564	Ferri Inductor FL7H 1.8 MH(J)	23-1-3	2	10-49x	ZS434160	Set Screw, hexagon socket 3x3(cup/p.)		1
7-VR1	EV561442	Semi-fixed/Vol. V10K8-4-2 (4US) 2 kΩ	36-10-254	2					
8-1x	BA624341	OSC, Power Supply P.C. Board Comp.	1.E-5618	1					
8-TR1	ET453611	Transistor 2SC1096(L)(K)(Z Type)	45-1-109	1					
8-TR2,3	ET511920	Transistor 2SC1247A (B)(V)	45-1-131	2					
8-D1,2	ED494583	Silicon Diode 10D05	45-2-42	2					
8-D3	ED511918	Zener Diode WZ-240	45-6-38	1					
8-7x	EZ628413	Heat-sink Plate	1.E-5619	1					
8-8x	ES494302	Slide SW. CL104B	25-3-79	1					
8-9x	EZ624071	Pin For V Connector, w/base RTB-1.5-6	32-1-60	1					
8-C6,7	EC558202	Trimmer/C. TM-80A	24-2-26	2					
9-116x	BT624058	Power Trans. LET-18	38-4-318	1					
9-117x	BT624115	Power Trans. LET-17(CEE)	38-4-321	1					
9-118x	BT624126	Power Trans. LET-19(CSA)	38-4-322	1					
9-119x	BT624137	Power Trans. LET-20(JPN)	38-4-323	1					
9-120x	EJ233370	Socket (Volt, Selector) S-18010	40-2-3	1					
9-121x	ES479485	Slide SW. S-1	25-1-66	1					
9-122x	ES641092	Slide SW. JE07 (JPN)	25-3-115	1					
9-123x	ES480857	Seesaw SW. TV-3 JA-07, w/loose hole	25-2-29	1					
9-124x	ES653534	Seesaw SW. JA-02 (CEE)	25-2-43	1					
9-125x	EF575932	Fuse 0.8A 250V	39-1-50	1					

When ordering parts, please describe Parts Number, Serial Number, and Model Number in detail.