The image features a circular graphic with a grainy, stippled texture. Inside the circle, there are five overlapping, dark, curved shapes that resemble the blades of a camera aperture. These shapes are arranged in a circular pattern, creating a central white space. In the center of this white space, the text "Pentax" is written in a bold, sans-serif font, with "K1000" written below it in a larger, bold, sans-serif font.

Pentax
K1000

Pentax K1000

contents

- 1 OPERATION AND FEATURES
- 4 OTHER FEATURES OF THE K1000
- 5 REMOVING THE BOTTOM COVER
- 8 REMOVING THE TOP COVER
- 12 WHAT'S NEXT?
- 13 THE K1000 EXPOSURE-METER SYSTEM
- 15 THE PHOTO SWITCH
- 16 TROUBLESHOOTING THE K1000 EXPOSURE METER
- 21 CHECKING THE GALVANOMETER
- 23 CHECKING THE SPEED RESISTOR
- 24 CHECKING THE DIAPHRAGM RESISTOR
- 25 REMOVING THE EXPOSURE-METER CIRCUIT BOARD
- 26 REPLACING THE SPEED RESISTOR
- 28 REMOVING THE DIAPHRAGM RESISTOR AND THE FRONT STANDARD
- 31 REMOVING THE PENTAPRISM FRAME
- 33 SHORTCUT TO REPLACING THE GALVANOMETER
- 34 CALIBRATING THE EXPOSURE METER
- 36 VARIATIONS ON THE K1000 METER
- 38 REMOVING THE EXPOSURE-METER ASSEMBLY AS A UNIT

Section 1

INTRODUCTION

Pentax Spotmatics have long been among the most popular of the 35mm SLRs. Adding a built-in, cross-coupled exposure meter turned the early Pentax SLRs into "Spotmatics." Yet even the recent Spotmatic models use basically the same shutter and transport systems as do the early Pentax cameras.

Most of the variations you'll encounter among Pentax Spotmatics are in the exposure-meter systems. The original Spotmatics use stopped-down metering and screw-mount lenses. But later models changed to full-aperture metering and bayonet-mount lenses. Yet, once past the exposure meter, you'll find the familiar Pentax shutter and transport.

Even the fully automatic, electronically controlled Spotmatics -- the ES models -- retain the same basic shutter mechanism. The ES just adapts the Pentax shutter and transport systems for fully automatic shutter-speed control.

That's why the K1000 provides a good representative for your thorough study. You'll be servicing many variations of the same camera. Also, the K1000 is quite representative in several general categories. It provides an excellent example of the double-roller focal-plane shutter, the mirror operation of the single-lens reflex, and the electrically cross-coupled exposure-meter system.

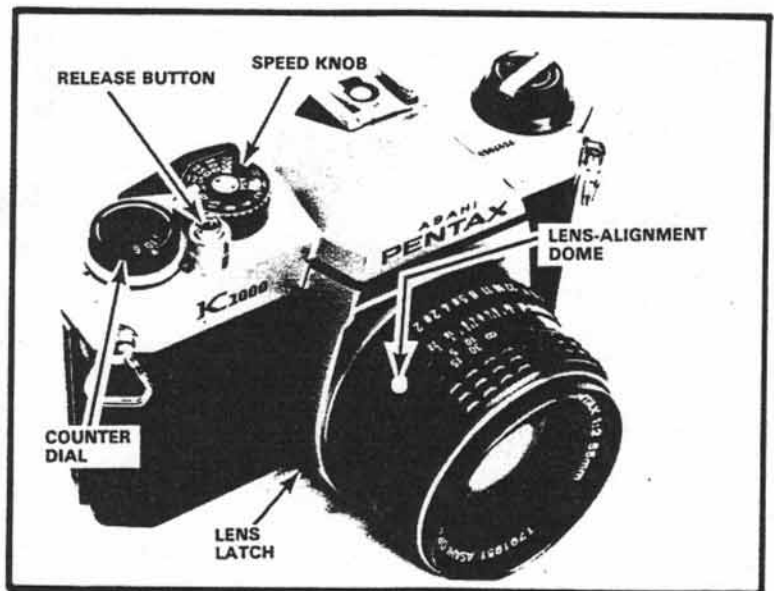
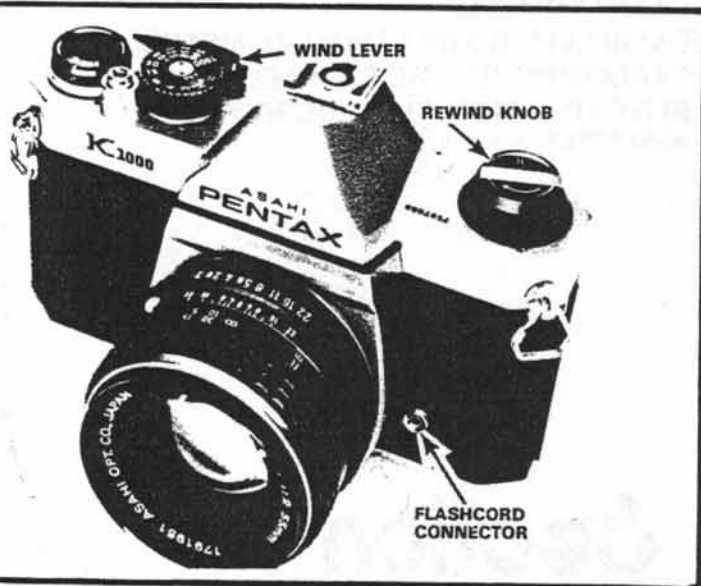

Figure 1 The K-series of Spotmatics have bayonet-mount lenses (rather than screw-mount lenses).

OPERATION AND FEATURES

The Pentax K1000, Fig. 1, provides full-aperture metering with semiautomatic control. The needle appears through the finder, Fig. 2. Just change the shutter speed or the f/stop until the needle centers in the focusing-screen mask. You've then set the camera controls for the proper exposure.

As you look through the finder, try changing the light coming through the lens. The needle should move up as you allow more light to pass through the lens to the focusing screen. The needle should move down as you decrease the light.

Also, try turning the speed knob, Fig. 3, as you look through the finder. The needle should move up as you set slower shutter speeds; it should move down as you set faster shutter speeds. Changing the f/stop by turning the diaphragm-setting ring, Fig. 3, should again move the needle -- up for larger f/stops and down for smaller f/stops.

But where's the on/off switch for the exposure meter? That's one of the unique features of the K1000 -- there appears to be no on/off switch. Yet the camera uses a CdS-metering system which requires battery power. Since the meter constantly draws current, it would seem you could expect very short battery life.



Pentax K1000

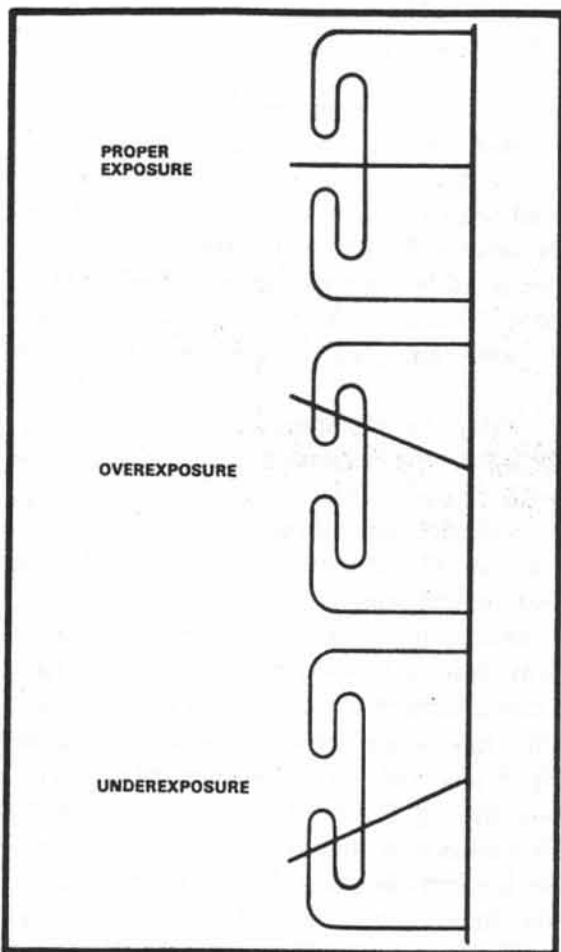

Figure 2

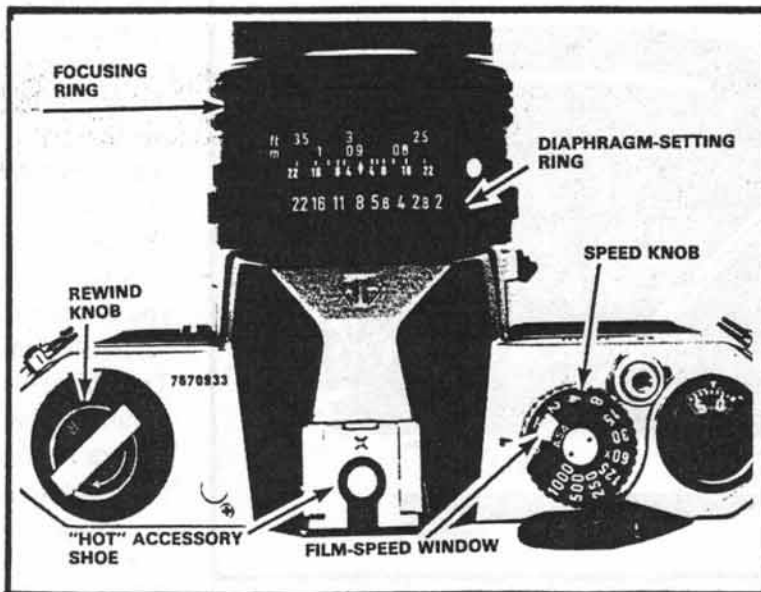

Figure 3

Actually, there is an on/off switch. The on/off switch works automatically according to the amount of light coming through the lens. When the light drops very low in intensity, a **photo switch** turns off the meter. The needle then centers in the finder mask, Fig. 2.

But the light must drop below EV 2 at ASA 100 to shut off the meter -- that's a very low intensity. So, unless you take precautions, you can indeed expect excessive battery drain.

What precautions? Well, when you're not using the camera, you should keep the lens cap in place. Yet even light coming through the eyelens can turn on the meter. Consequently, you should also keep the camera in its carrying case.

Since you can't expect camera owners to always take these precautions, your customers will be coming to you with a relatively simple problem -- a dead battery. Remember, with a dead battery the needle remains centered in the mask. And the customer may think that the controls are properly set for the light conditions. As a result, he gets underexposed or overexposed pictures.

You should then check to see if the needle moves as you change the light conditions and the camera settings. If there's no needle movement, **replace the battery as your first step in troubleshooting.**

The K1000 uses one silver-oxide 1.5-volt battery. To remove the battery, unscrew the battery-compartment cover at the bottom of the camera, Fig. 4. The negative terminal of the battery goes down; the positive terminal makes the ground connection.

After replacing the battery, again check the meter's operation. Like other Spotmatics, the K1000 uses an electrically cross-coupled exposure meter. Changing the shutter-speed setting, the film-speed setting, or the diaphragm opening programs a resistance value into the exposure-meter system.

Set the shutter speed by rotating the speed knob, Fig. 3. To set the film speed, lift and rotate the speed knob. The film-speed setting then shows through a window in the speed-knob calibration plate.

When you're setting the film speed or the shutter speed, the speed knob programs the resistance setting of a variable resistor. The variable resistor sits under the speed knob. However, there's a second variable resistor which programs the diaphragm setting. The diaphragm resistor is a large resistor ring behind the lens mount.

You can see the coupling to the diaphragm resistor after you remove the lens. Just push in the **lens latch**, Fig. 1. Then rotate the lens a partial turn in a counterclockwise direction. To replace the lens, first locate the red dot on the bayonet-mounting ring, Fig. 5; align this red dot with the red dot on the camera's lens-mounting ring, Fig. 6. The lens should seat fully. Now, rotate the lens clockwise until you feel it latch in place.

Notice that the lens provides a special convenience feature -- a lens-alignment dome, Fig. 1. The lens-alignment dome helps you change lenses when you're shooting pictures at

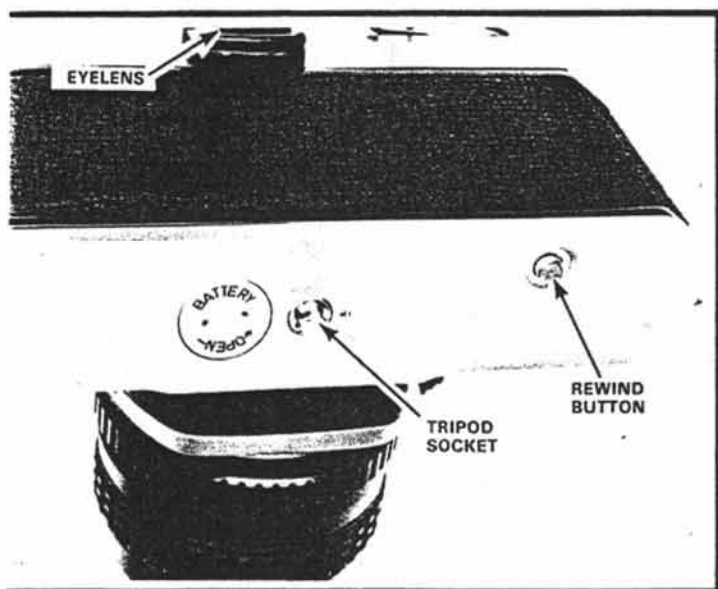

Figure 4
The K1000 uses one 1.5V silver-oxide battery (Eveready S-76 or equivalent)

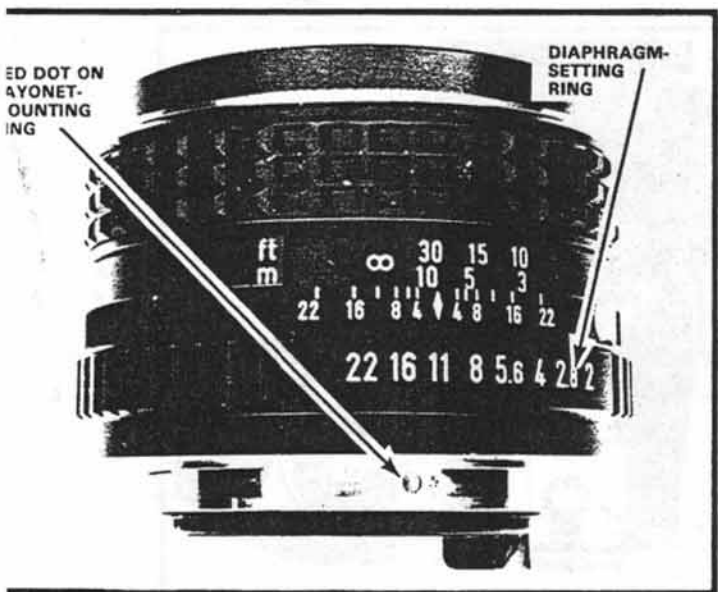

Figure 5

night. Even though you can't see the alignment dots, you can feel the positions of the lens-alignment dome and the lens latch, Fig. 1. Just align the lens-alignment dome with the lens latch to seat the lens. Then, turn the lens clockwise until it latches in place.

With the lens removed, locate the tab on the **diaphragm-metering ring**, Fig. 6. The tab couples to another tab at the back of the lens -- the **diaphragm-setting-ring tab**, Fig. 7. Try turning the diaphragm-setting ring as you watch the diaphragm-setting-ring tab. Notice that the diaphragm-setting-ring tab turns clockwise as you set smaller apertures; it turns counterclockwise as you set larger apertures.

Consider now that the diaphragm-setting-ring tab is coupled to the top of the diaphragm-metering-ring tab -- that's the situation when you have the lens mounted to the camera. Setting a larger aperture then pulls down the tab on the diaphragm-metering ring. As the diaphragm-metering ring turns clockwise, it programs a larger resistance into the exposure-meter system.

Each f/stop has its own resistance value. The resistance setting of the diaphragm resistor now tells the exposure-meter system what f/stop you've selected.

An internal spring tries to turn the diaphragm-metering ring in a counterclockwise direction. So, to check the action, use your finger to rotate the diaphragm-metering ring clockwise -- you should be able to feel the resistance of the internal spring. Then, release the diaphragm-metering ring; the internal spring should return the diaphragm-metering ring to the position shown in Fig. 6.

In Fig. 6, you can also see the coupling to the diaphragm-control ring. With the lens removed, the diaphragm-controlling spring stops down the diaphragm leaves. The diaphragm closes to whatever f/stop you've selected.

Normally, though, the tab on the diaphragm-control ring, Fig. 7, sits on top of the **diaphragm-control lever**, Fig. 6. The diaphragm-control lever then holds the diaphragm in the full-open position.

Watch the diaphragm-control lever as you cock and release the shutter. As the mirror starts moving up, the diaphragm-control lever moves down. The diaphragm-control lever now allows the spring-loaded diaphragm to close. Again, the diaphragm closes to the f/stop you've selected on the diaphragm-setting ring.

After the exposure, the diaphragm-control lever moves up -- it returns to the position shown in Fig. 6. The diaphragm-control lever then opens the diaphragm to the largest aperture.

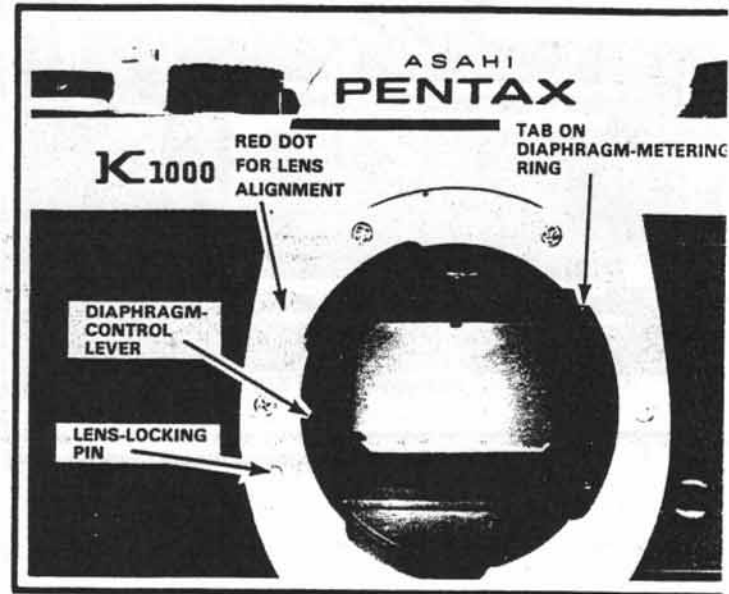

Figure 6
The lens-locking pin drops into a slot in the back of the lens (Fig. 7). Pushing in the lens latch withdraws the lens-locking pin; you can then remove the lens.

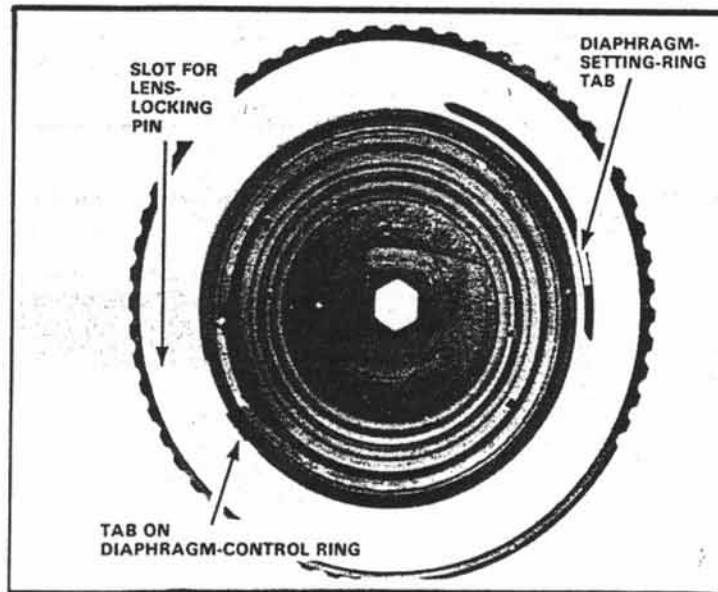

Figure 7

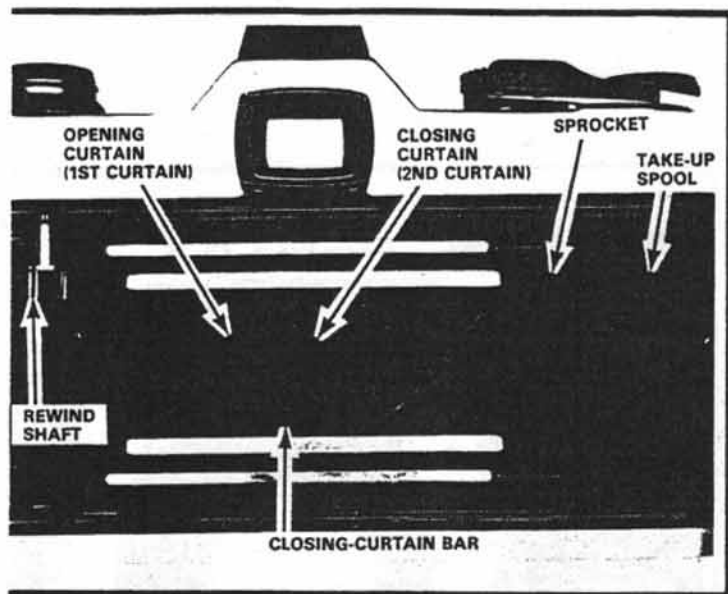

Figure 8 Curtain movement during cocking cycle

OTHER FEATURES OF THE K1000

To open the camera back, just pull up the rewind knob. Try watching the curtains from the back of the focal-plane aperture as you cock and release the shutter; note the action of the horizontally traveling focal-plane shutter.

The two curtains, Fig. 8, move from left to right as you cock the shutter. When you release the shutter, the opening curtain (or "first curtain") starts the exposure by moving from right to left. The closing curtain (or "second curtain") completes the exposure when it moves from right to left.

As you cock the shutter, check the curtain overlap, Fig. 8. Notice that the closing-curtain bar completely overlaps (covers) the opening-curtain bar. Typically, Spotmatics (and most other focal-plane shutters) have a full-bar overlap; one bar completely covers the other bar. The overlap prevents light from reaching the film during the cocking cycle.

Also try watching the curtains as you operate the camera at different shutter-speed settings. At the slow speeds -- 1 second through 1/30 second -- you can hear the sound of the speeds escapement during the exposure. The speeds escapement holds back the closing curtain for the length of time you've selected on the speed knob.

Now, set the speed knob to 1/60 second. 1/60 second is the fastest full-aperture speed. Here, the two curtains completely uncover the focal-plane aperture during the exposure. But the speeds escapement does not hold back the closing curtain. Instead, the closing curtain releases after the opening curtain has completely uncovered the focal-plane aperture.

At the faster speeds, the closing curtain releases while the opening curtain is still moving across the aperture. The width of the slit formed between the two curtains then determines the shutter speed: The faster the shutter-speed setting, the smaller the slit width -- a smaller distance between the two curtains.

Remember, though, that you only get a full aperture at the speeds of 1/60 second and slower. That means 1/60 second is the fastest speed at which you can use electronic flash.

The X-sync contacts close when the opening curtain uncovers the focal-plane aperture. At this time, the closing curtain must not be in the aperture; the aperture has to be completely uncovered for electronic flash. Although the K1000 has X-sync contacts and FP-sync contacts, it only allows you to use the X-sync contacts.

Why? There's only one flashcord terminal on the camera, Fig. 1. This flashcord terminal connects to the X-sync contacts. In other Spotmatic models, you'll find two flashcord terminals -- one for X sync and one for FP sync. However, few people use flashbulbs these days. Since there's little need for FP synchronization, Pentax lowered the cost of the camera by eliminating the FP-flashcord terminal. As you'll discover a little later, the FP-sync contacts do serve a second purpose in the camera.

There's another part the K1000 has eliminated to reduce the selling price -- the self timer. Most Spotmatic models have

self timers. As you'll see, the K1000 has the space and coupling for the self-timer mechanism. But, by leaving out the self-timer feature, Pentax could sell the same camera for a lower price.

The other camera features remain the same in the various Spotmatic models. Even the very early Pentax SLR's provide the **shutter-cocked indicator**. When you cock the shutter, a red section of the shutter-cocked indicator shows through the top-cover window, Fig. 9; the red flag serves to warn you that the shutter is in the cocked position. A black section of the shutter-cocked indicator shows through the top-cover window when the shutter is released.

The operation of the counter dial is also the same in the many Spotmatic models. Try opening the camera back -- the counter dial should snap to the large-dot position, Fig. 9. Then, close the camera back and advance the wind lever. The counter dial should rotate one film-frame calibration each time you cock the shutter.

Note how many wind-lever strokes it takes to reach the first film-frame calibration. The first wind-lever stroke advances the counter dial to the small-dot position. And the second wind-lever stroke advances the counter dial to the "0" calibration, Fig. 10. When you advance the wind lever a third time, you're ready to shoot the first picture.

REMOVING THE BOTTOM COVER

Regardless of the malfunction, you'll normally want to begin your disassembly by removing the bottom cover. Unscrew the battery-compartment cover and lift out the battery. Then, take out the three screws holding the bottom cover. Notice that the screw by the tripod socket has a smaller head size than do the other two screws.

Lift off the bottom cover. There's only one loose part to watch for -- the plastic dust seal which sits over the rewind button, Fig. 11. Remove the dust seal to prevent loss.

The parts now visible at the wind-lever side, Fig. 11, operate the mirror. We'll cover the mirror operation in detail a little later. For now, just cock and release the shutter a few times while observing the parts.

Notice that the **lower wind gear**, Fig. 11, rotates as you cock the shutter. A teflon bushing on the lower wind gear passes through a slot in the **mirror-cocking lever**. So, as the lower wind gear rotates, it drives the mirror-cocking lever in a counterclockwise direction.

The right-hand end of the mirror-cocking lever, Fig. 11, now comes against the **mirror-tensioning lever**. As a result, the mirror-cocking lever pushes the mirror-tensioning lever toward the front of the camera. The mirror-tensioning lever is part of the mirror cage; a clearance slot in the bottom of the camera allows the mirror-tensioning lever to engage the mirror-cocking lever.

As the mirror-tensioning lever moves toward the front of the camera, it tensions the **mirror-lifting spring**. You can't as

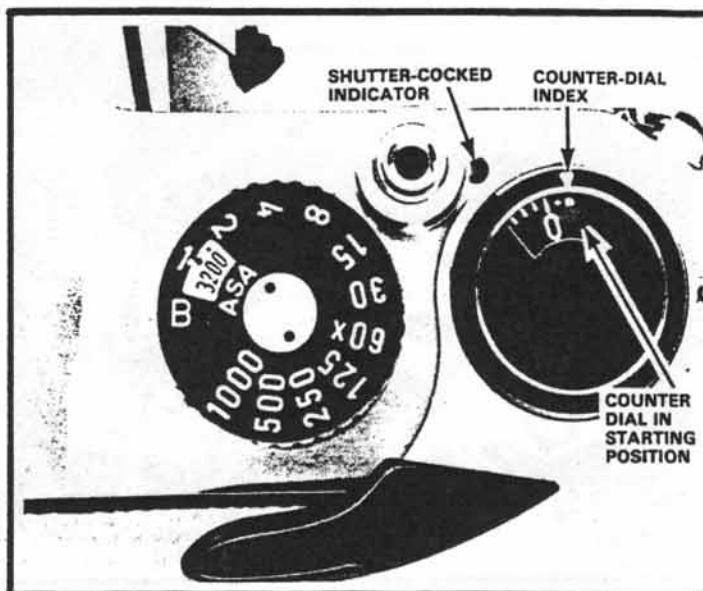

Figure 9

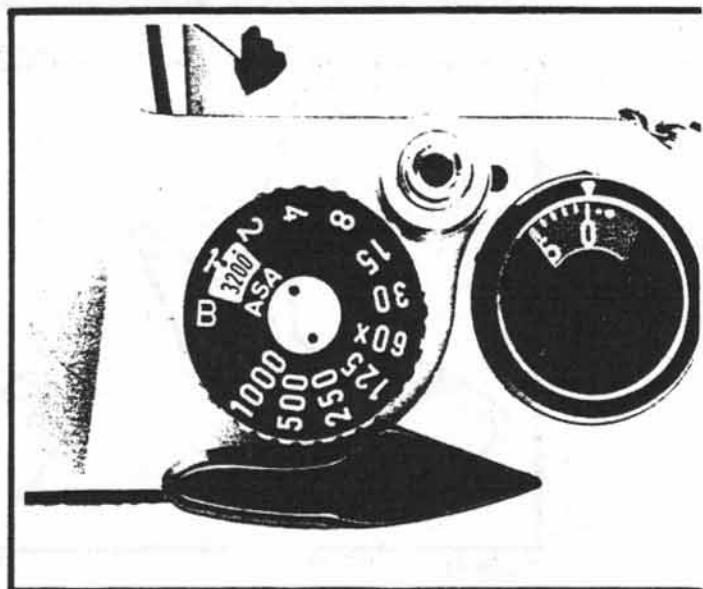

Figure 10

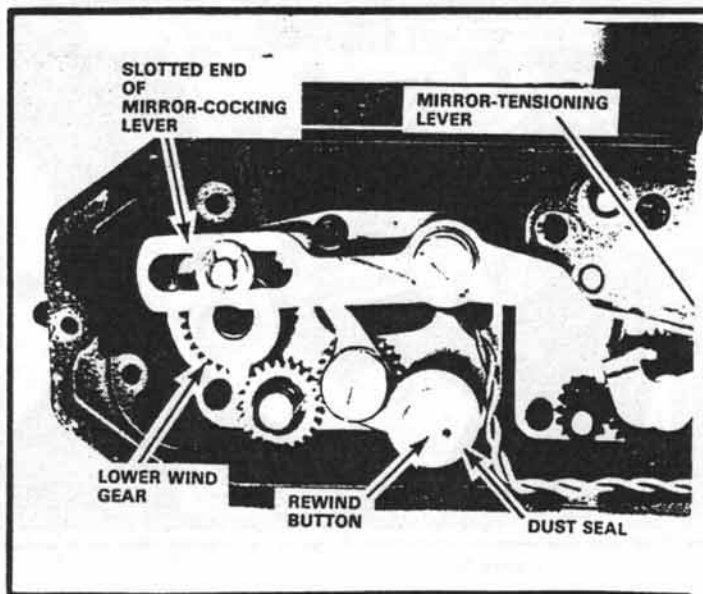

Figure 11 Shutter released

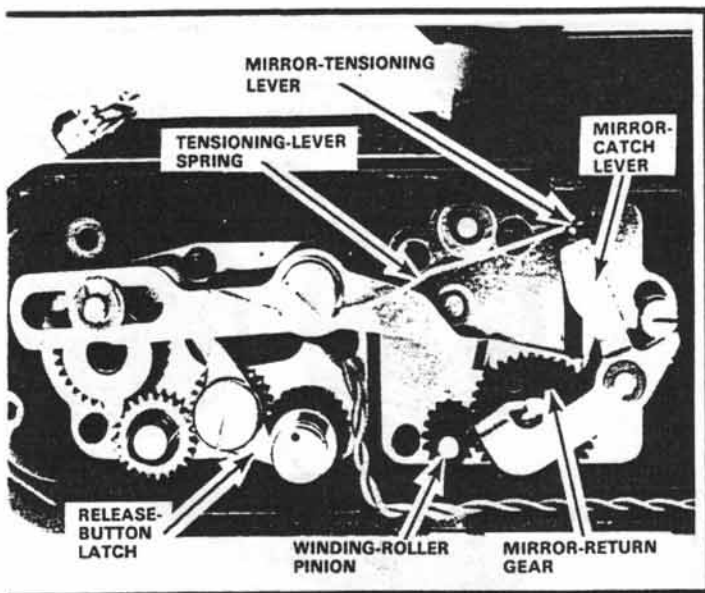

Figure 12 Shutter cocked

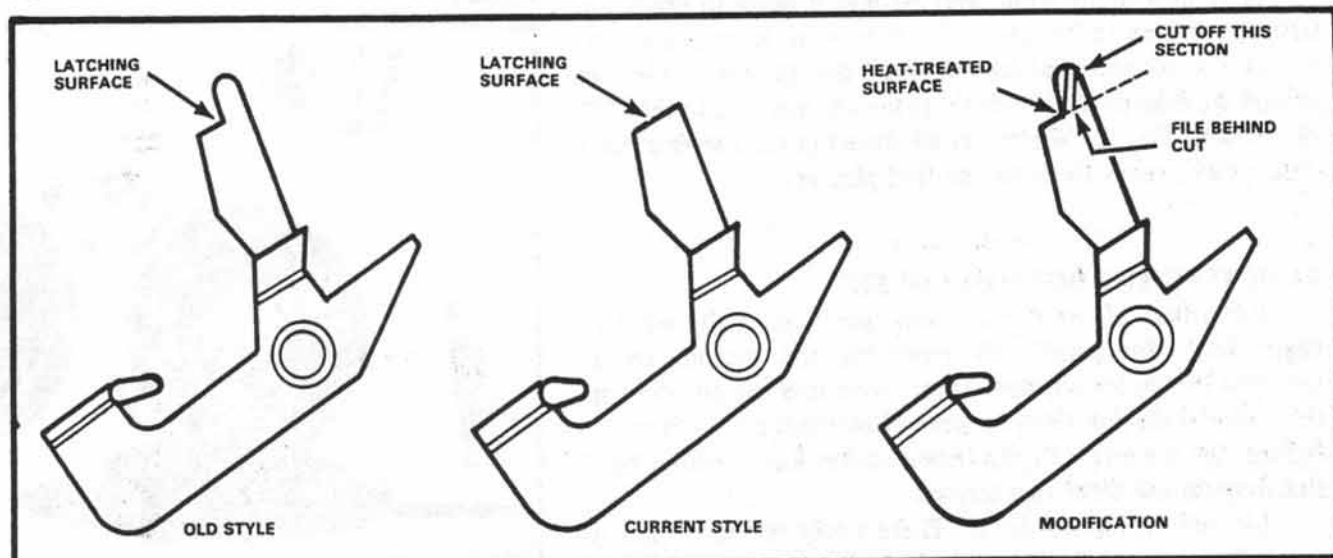

Figure 13

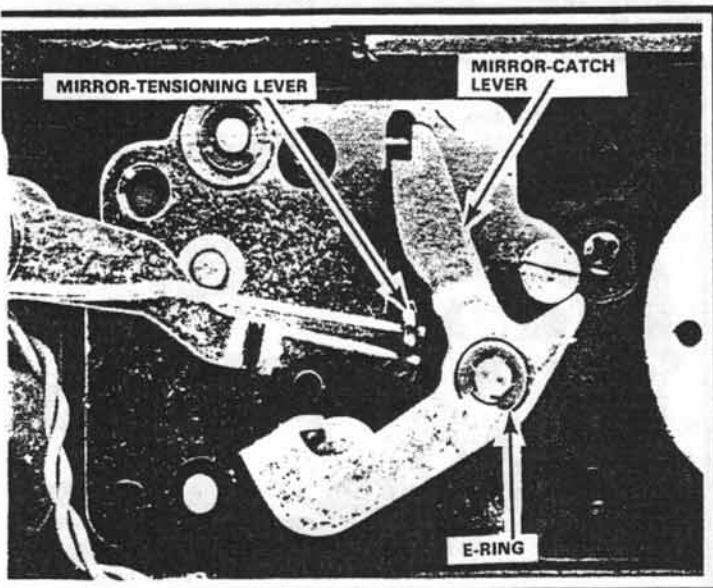

Figure 14

yet see the mirror-lifting spring -- it's the spring at the bottom of the mirror cage which drives the mirror to the taking position.

Finally, with the shutter fully cocked, the **mirror-catch lever**, Fig. 12, latches the mirror-tensioning lever. Notice in Fig. 12 that the mirror-cocking lever has returned to its starting position. As the lower wind gear completes its rotation, it returns the mirror-cocking lever.

The mirror is now tensioned, ready for the exposure. When you push the release button, the mirror-lifting spring drives the mirror to the taking position. And the mirror releases the opening curtain to start the exposure.

After the exposure, the mirror returns to the viewing position. What part allows the mirror to return? The mirror can't return until the mirror-catch lever disengages the mirror-tensioning lever. So look for the part that disengages the mirror-catch lever after the exposure.

Notice that the **mirror-return gear**, Fig. 12, rotates as the closing curtain moves across the aperture. The mirror-return gear then kicks the mirror-catch lever out of engagement with the mirror-tensioning lever. Now, the mirror-tensioning lever returns to its starting position. And the mirror returns to the viewing position. The mirror-return gear always rotates with the closing curtain; it engages a pinion that connects to the bottom of the closing-curtain winding roller, Fig. 12.

Again, we'll cover the operation in more detail a little later. But you should always study the operation as soon as you remove the bottom cover; you can learn a lot about the camera just by observing the exposed parts. And, in many of the early Spotmatics, this is as far as you'll have to go to correct one of the most common problems.

In the earlier Spotmatics, the mirror-catch lever has a slightly different shape. Compare the mirror-catch lever in the

K1000 with an earlier design, Fig. 13. The notch in the earlier design engages the mirror-tensioning lever; in the K1000, the latching end of the mirror-catch lever is flat.

The problem with the earlier style is that the mirror-catch lever may not provide a secure latching action. Bumping or jarring the camera can sometimes disengage the mirror-catch lever from the mirror-tensioning lever. The customer then brings you a "jammed" camera -- a camera that will neither cock nor release.

Fig. 14 shows what you'll see after removing the bottom cover. The mirror-catch lever is in the shutter-cocked position. But the mirror-tensioning lever has returned to the shutter-released position.

What's happened here? The owner has jarred the camera with the shutter in the cocked position. As a result, the mirror-tensioning lever has jumped out of engagement with the mirror-catch lever. Now, there's no spring tension to drive the mirror to the taking position. Consequently, the shutter won't release.

You can correct the problem fairly easily. Just remove the E-ring holding the mirror-catch lever. Then, lift the mirror-catch lever high enough to free the jammed mirror-tensioning lever. You can now push the mirror-tensioning lever toward the front of the camera until it's once again latched by the mirror-catch lever, Fig. 15.

A simple repair, right? But if the customer again jars the camera with the shutter cocked, he may have the same problem. You can make a more permanent repair by modifying the mirror-catch lever. Just cut off the top lip indicated in Fig. 13; then file the latching surface to match the shape of the current style. Don't try to file the heat-treated section of the mirror-catch lever, Fig. 13.

While you're at the bottom of the camera, also examine the battery compartment. The black wire connects to the negative battery-compartment terminal, Fig. 16. This wire goes to the exposure-meter assembly at the top of the camera.

The two red wires which are twisted together go to the X-sync contacts. You can't as yet see the X-sync contacts -- they're inside the camera. The other ends of the red wires, Fig. 16, go to the flashcord contacts.

Fig. 16 also shows the curtain tension-setting adjustments. You'll use these adjustments to set the curtain-travel times -- how fast the curtains move during their release travel. We'll cover the adjustment procedures in the shutter section of this manual.

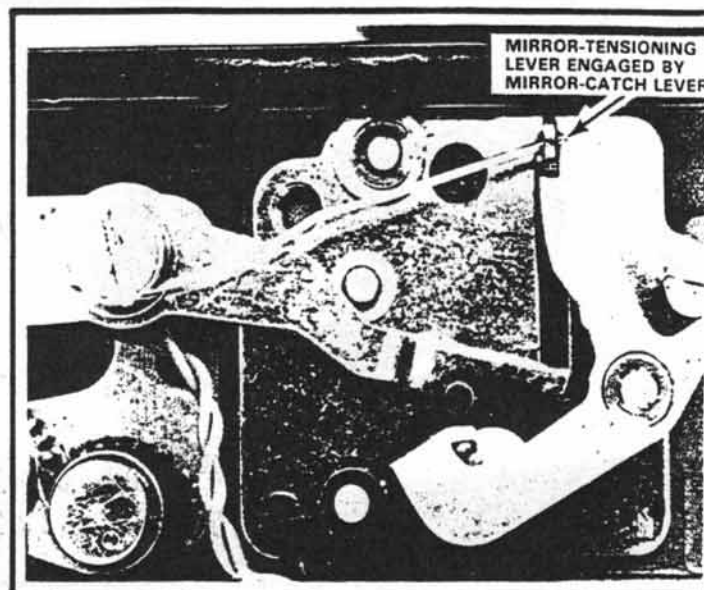

Figure 15

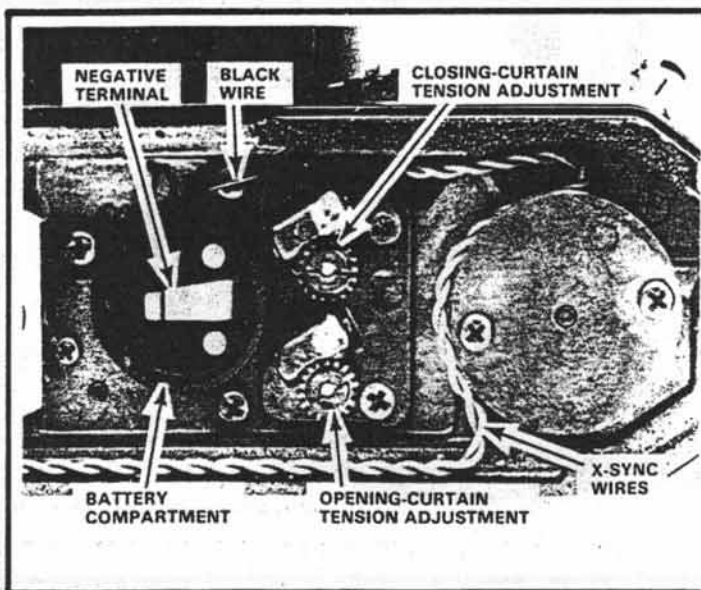

Figure 16

The K1000 has a stainless-steel negative battery terminal to minimize corrosion problems.

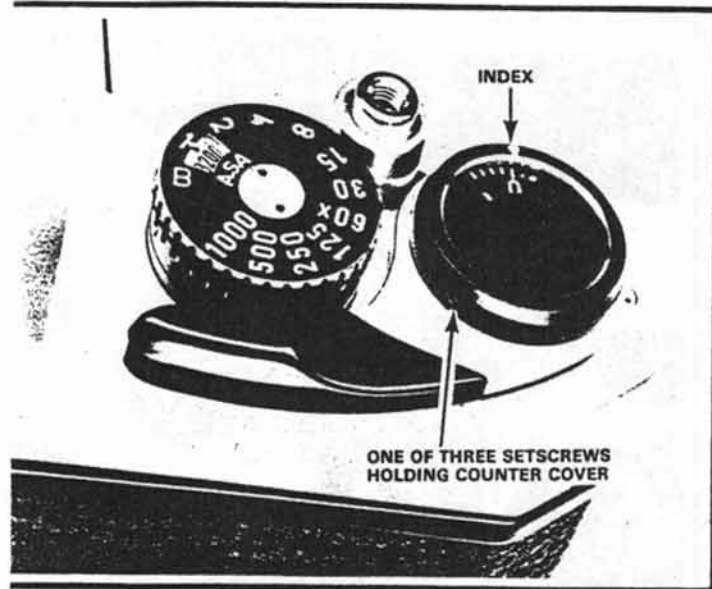

Figure 17

REMOVING THE TOP COVER

The procedure for removing the top cover remains practically unchanged in the various Spotmatic models. Starting with the wind lever, loosen the three setscrews which hold the counter cover, Fig. 17. Then, lift off the counter cover.

REASSEMBLY: When you replace the counter cover, you must properly align the index, Fig. 17, with the counter-dial calibrations. First, open the camera back; the counter dial then returns to its starting position. The index should now align with the large dot on the counter dial, Fig. 9. But it's pretty tough to precisely align the index with a dot. So close the camera back; then cock and release the shutter two times. Now, seat the counter cover. Rotate the counter cover until its index aligns with the "0" calibration, Fig. 18, and tighten the three setscrews.

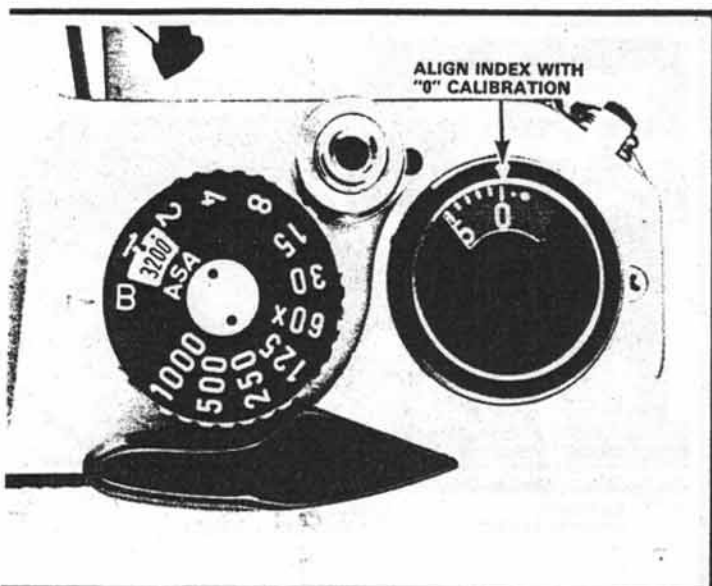

Figure 18

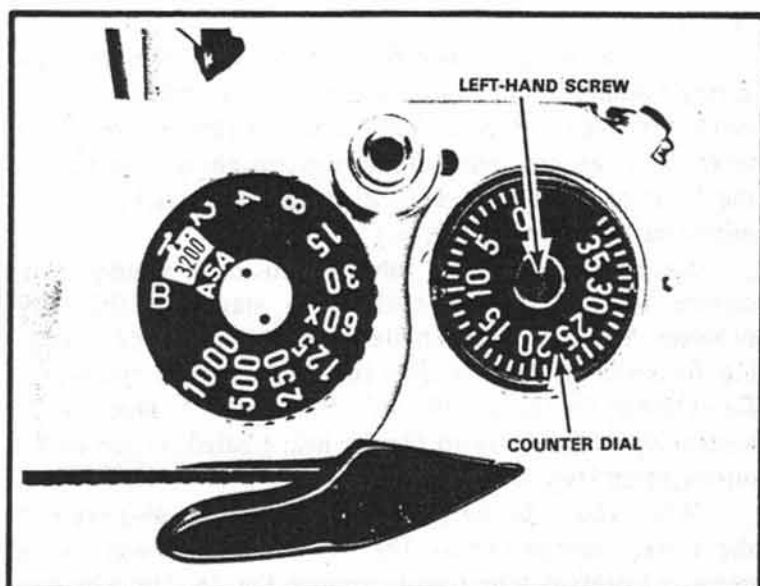

Figure 19

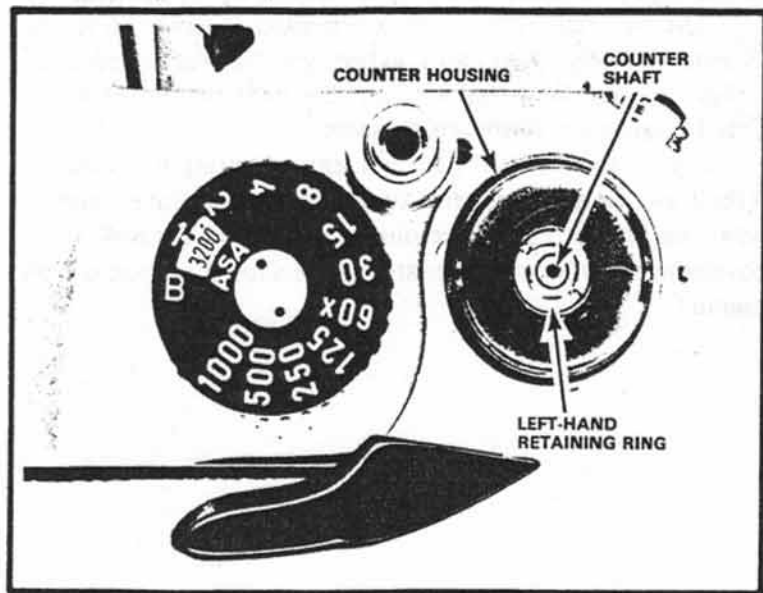

Figure 20

Next, locate the center screw holding the counter dial, Fig. 19 -- *this screw has a left-hand thread*. Remove the screw by turning it in a clockwise direction and lift off the counter dial. Notice that a flat surface on the inside of the counter-dial hole keys to a flat side on the counter shaft, Fig. 20.

NOTE: In early Spotmatic models, the counter-dial return spring is underneath the counter dial; the spring unwinds when you lift off the counter dial. In later models, such as the K1000, the counter-return spring acts internally on the counter shaft; the spring remains inside the wind-lever-shaft assembly.

You can now see the retaining ring holding the counter housing, Fig. 20. In early Spotmatic models, this retaining ring has a normal (right-hand) thread. However, the retaining ring has a left-hand thread in later models -- including the K1000. Remove the retaining ring by turning it in a clockwise direction. Then, lift off the counter housing.

The **bayonet retaining spring**, Fig. 21, provides the two positions for the wind lever -- the ready position (away from the camera body) and the storage position (against the camera body). Remove the three screws holding the bayonet retaining spring, Fig. 21. Then, turn the bayonet retaining spring until its three lugs align with the three slots in the wind driver, Fig. 21. Finally, lift off the bayonet retaining spring and the wind lever.

A pin on the underside of the wind lever passes through the cutout in the wind driver, Fig. 22. Notice also the dust seal in Fig. 22. If you replace the dust seal upside down, the cutout won't align with the slot for the wind-lever pin. So be sure to replace the dust seal as shown in Fig. 22.

Since the K1000 uses an electrically cross-coupled meter, you won't lose any timing by removing the speed knob. However, for reference, set the speed knob to bulb. It doesn't matter what film-speed setting you use (you'll see why in a moment). Still, with an unfamiliar camera, it's good practice to use the fastest film-speed setting. If you're not familiar with the camera -- or if you don't have specific service information -- you might not know whether the camera uses mechanical or electrical coupling.

Here's one precaution you should note before removing the speed-knob calibration plate:

With many speed-knob designs, removing the speed-knob calibration plate uncovers a compression spring. Cameras which use the same speed knob for both the film-speed and the shutter-speed settings normally have the compression spring.

You can feel the action of the compression spring as you lift the speed knob to set the film speed. Lifting the speed knob

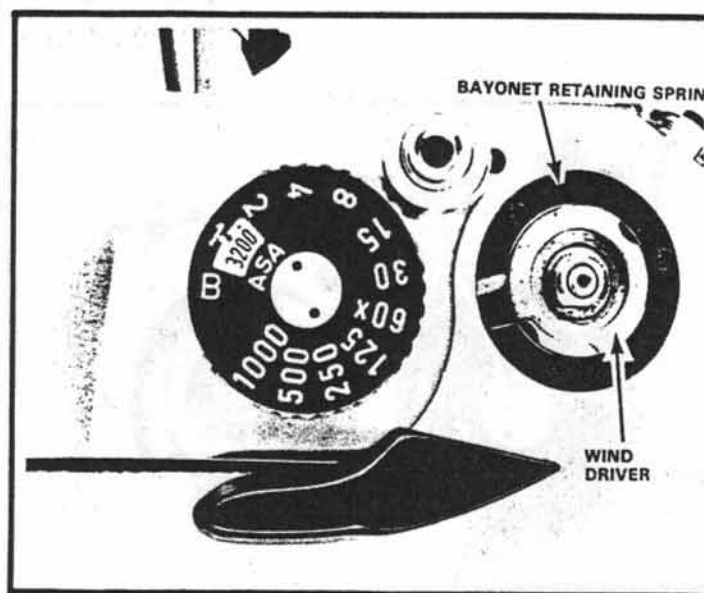

Figure 21
The three raised lugs of the bayonet retaining spring go up.

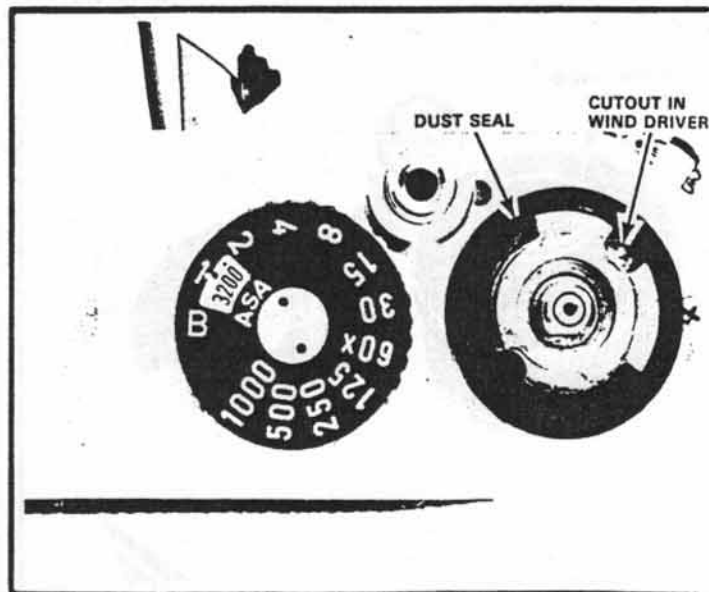

Figure 22

"compresses" the compression spring. The compression spring then tries to push down the speed knob.

Hold down the speed-knob calibration plate as you remove the center screw, Fig. 23. Then, allow the compression spring to push up the speed-knob calibration plate. Lift out the speed-knob calibration plate and the film-speed dial, Fig. 24. Also lift out the compression spring, Fig. 25.

Notice the slot in the speed knob, Fig. 26. This slot receives the tab on the underside of the film-speed dial, Fig. 26. Because of the compression spring, the reassembly of the speed-knob parts can be a little tricky. The compression spring tries to push up the film-speed dial and the speed-knob calibration plate as you're assembling the parts.

So, before completing the top-cover disassembly, we'll go through the reassembly for the speed knob. But first lift off the speed knob to see the coupling.

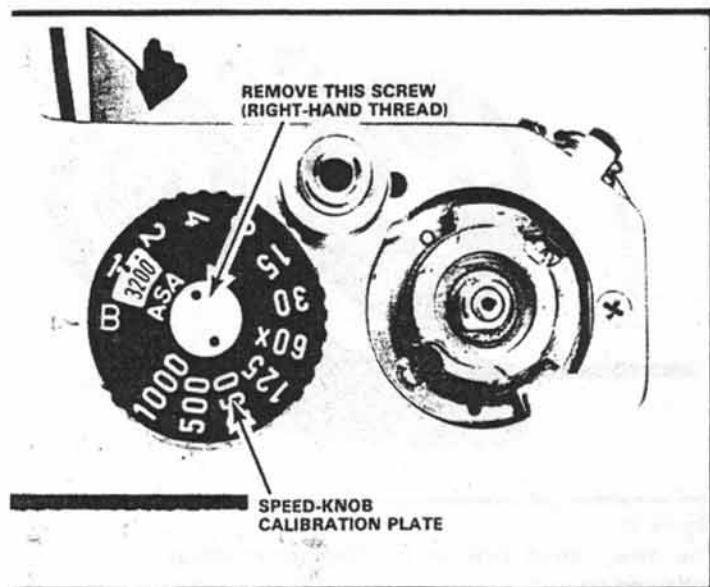

Figure 23

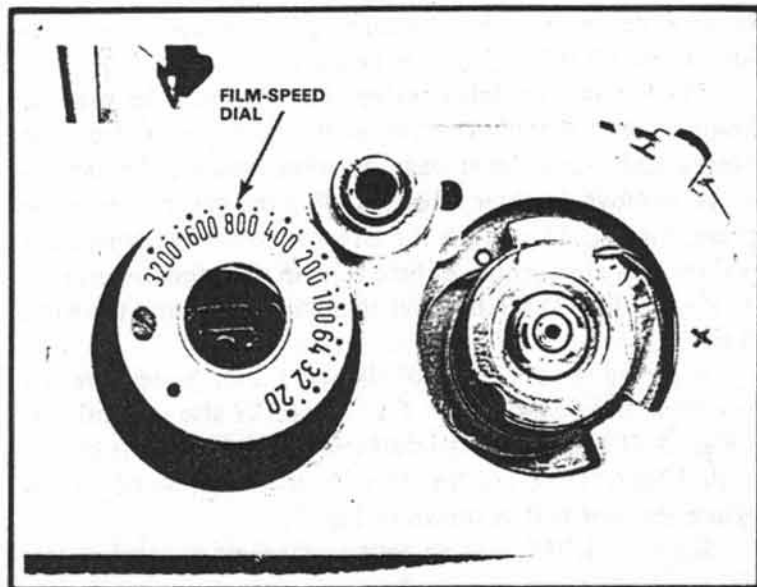

Figure 24

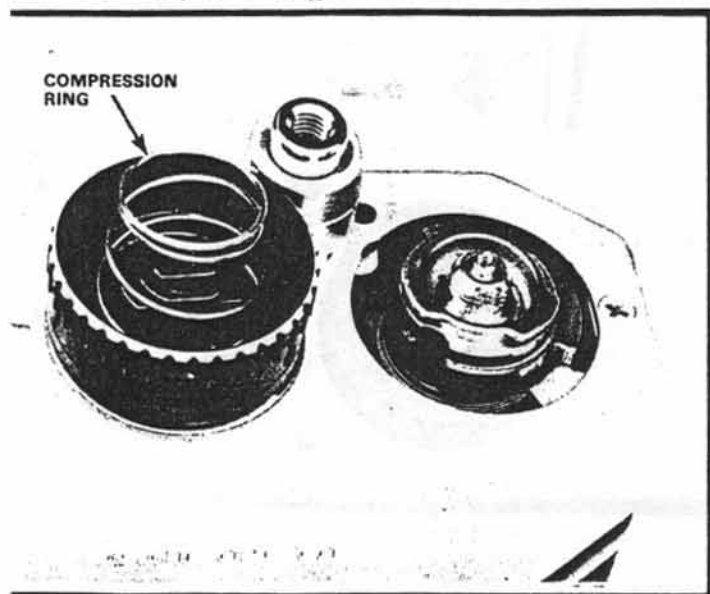

Figure 25

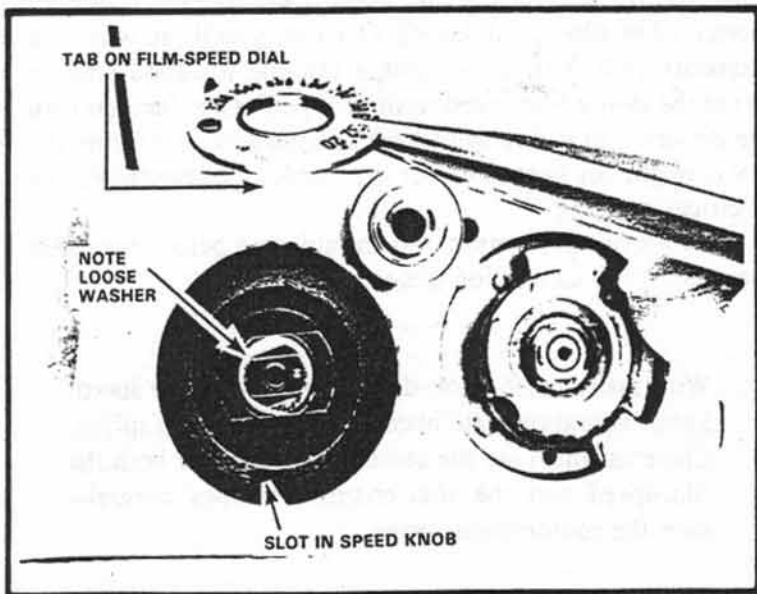

Figure 26

Notice the slot on the underside of the speed knob -- this slot fits over a tab on the speed-resistor turning ring, Fig. 27. Remember, changing either the shutter speed or the film speed sets the resistance of the speed resistor. That's how the exposure-meter system knows the film-speed and shutter-speed settings.

You can disassemble and reassemble the speed knob at any film-speed setting. As long as you properly align the parts, there's no timing to worry about. Let's now take a look at the reassembly procedure. You might want to practice removing and replacing the speed knob a few times to get the "feel" of the procedure.

REASSEMBLY: Start with the speed selector, Fig. 27, in the bulb position. You can now rotate the speed selector to any shutter-speed setting. At bulb, the speed-selector timing dimple, Fig. 28, points to the wind-lever end of the camera.

Now, seat the speed knob over the speed selector -- make sure the tab on the speed-resistor turning ring passes through the speed-knob slot. Seat the compression spring within the speed knob as shown in Fig. 25; the larger spring coils go down, toward the speed knob.

Next, place the film-speed dial in position; pass the tab of the film-speed dial through the speed-knob slot, Fig. 26. You'll now have to hold down the film-speed dial to keep the tab within the slot. Otherwise, the compression spring will push the film-speed dial out of position.

Here's the tricky part: while you're still holding down the film-speed dial, replace the speed-knob calibration plate. You can use your tweezers to hold down the film-speed dial. Then, slip the speed-knob calibration plate into place. As you lift your tweezers, use the speed-knob calibration plate to hold down the film-speed dial.

The hole in the center of the speed-knob calibration plate keys to the two flats on the speed selector, Fig. 28. Once you've seated the speed-knob calibration plate over the speed selector, the "B" calibration should be pointing to the index. You can then replace the center screw.

The tricky part of the whole procedure is getting the speed-knob calibration plate seated without allowing the film-speed dial to separate from the speed knob. After replacing the center screw, Fig. 23, test the operation -- just lift and turn the speed knob. If you can properly set the film speed, you know that you've correctly reassembled the speed-knob parts.

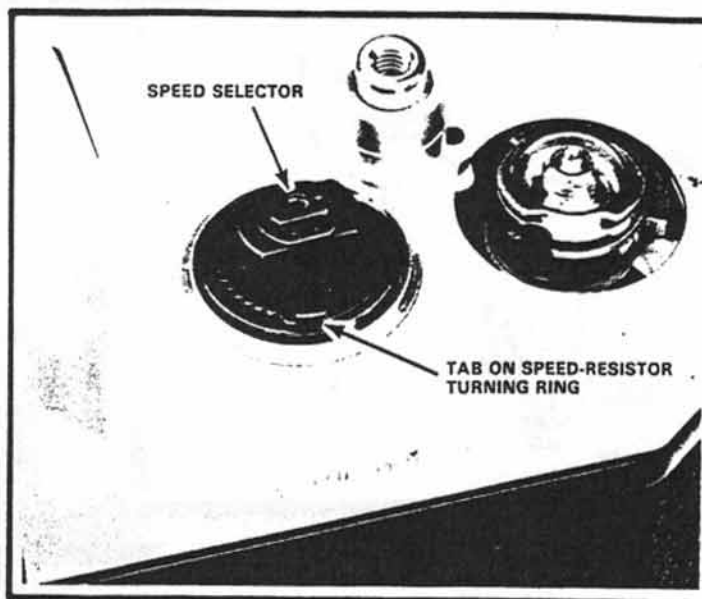

Figure 27

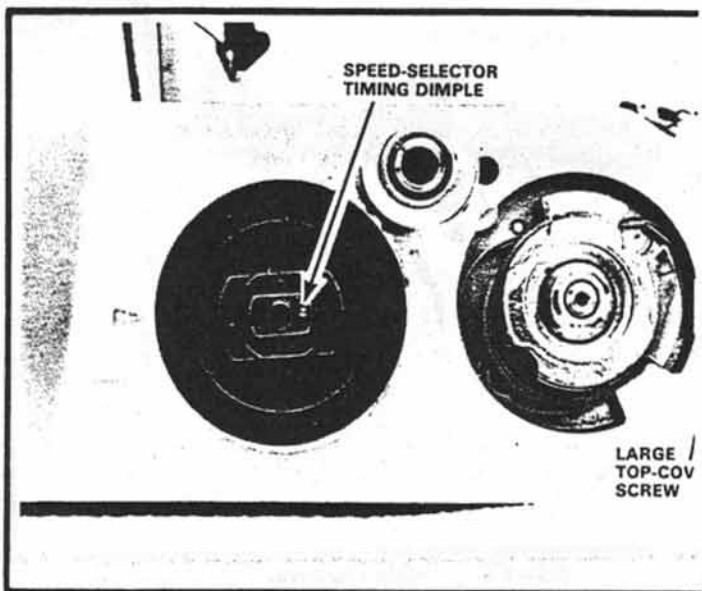

Figure 28 Bulb setting

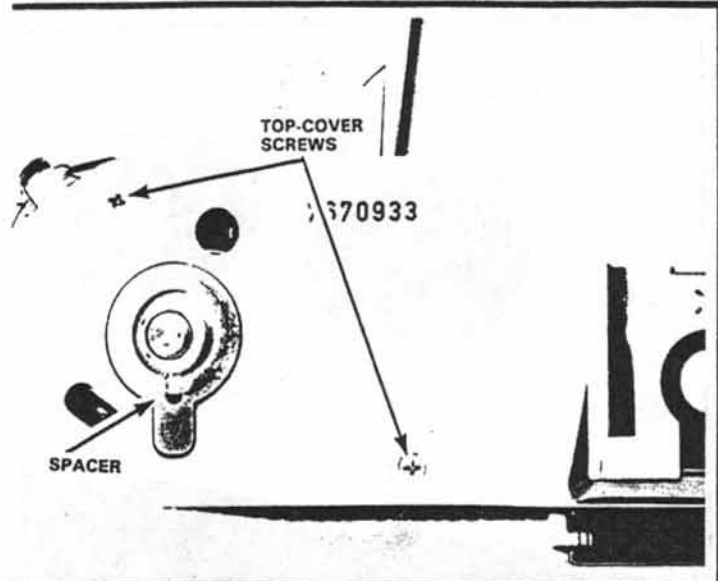

Figure 29

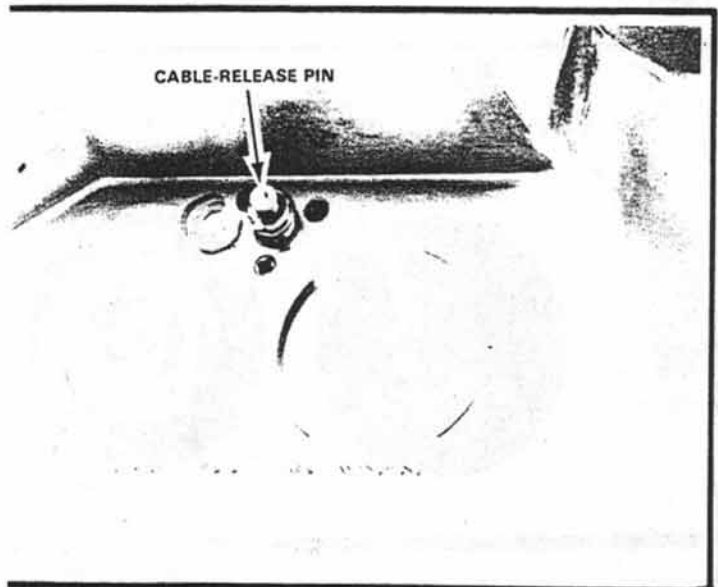

Figure 30 Inside top cover

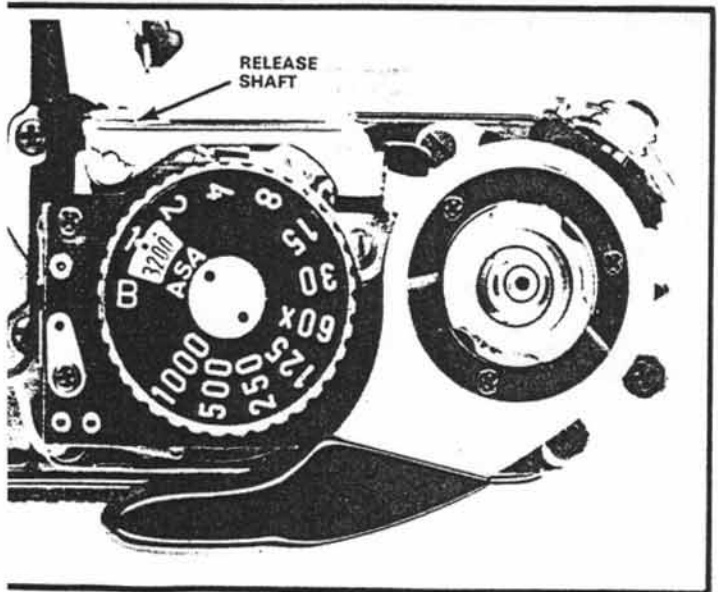

Figure 32

Remove the speed knob once again to proceed with the disassembly. Open the camera back. Then, wedge the rewind fork and unscrew the rewind knob. You can now see the retaining ring which screws onto the rewind shaft. Use your Multispan wrench to unscrew the retaining ring. Next, lift out the loose spacer which sits on top of the rewind shaft, Fig. 29.

Only three screws now hold the top cover -- two small screws on the rewind side and one larger screw on the wind side. Remove the three screws and slide off the top cover. But watch for the cable-release pin which fits inside the release button; the cable-release pin, Fig. 30, is now loose and could fall out.

There's one other loose part -- the decorator strip, Fig. 31. A ridge in the bottom of the plastic decorator strip sits over the top edge of the front decorator plate. Lift out the plastic decorator strip before proceeding.

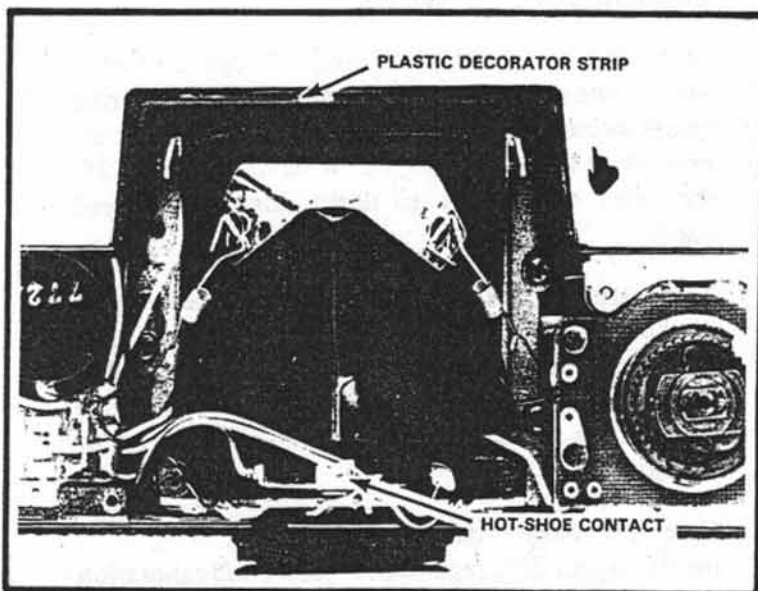

Figure 31 The hot-shoe contact engages a contact in the top-cover accessory shoe.

WHAT'S NEXT?

You may be disassembling the camera to correct a shutter problem or to repair the exposure meter. But, in either case, there are two parts you should replace before proceeding -- the speed knob and the wind lever.

Why? Well, you need these parts in place to make your tests and adjustments. Many people try to get along without taking the time to replace the parts -- or to replace the parts properly. Yet they usually end up wasting time. It takes too long to cock the shutter without the wind lever. And it takes too long to set shutter speeds without the speed knob.

In Fig. 32, we've replaced the wind lever and the speed-knob assembly. Notice that we've also replaced the three screws holding the bayonet retaining spring. Actually, the

bayonet retaining spring will hold the wind lever; you don't really have to replace the three screws. There's one advantage, though, in replacing all three screws -- you can then keep the screws with the parts they hold.

After replacing the wind lever and speed knob, try cocking the shutter. Release the shutter by depressing the release shaft, Fig. 32.

THE K1000 EXPOSURE-METER SYSTEM

You can now see most of the exposure-meter system, Fig. 33. The wires from the speed resistor are twisted together, passing over the top of the pentaprism. These wires then connect to the exposure-meter circuit board, Fig. 33. The wires from the diaphragm resistor and the galvanometer also connect to the exposure-meter circuit board.

Early models of the Spotmatic obtain the center-the-needle principle by using a balanced-bridge circuit -- the needle centers when the bridge is balanced. But later models completely changed the circuit. The later models, like the K1000, obtain the center-the-needle concept by using a unique galvanometer design.

The galvanometer has two separate coils wound on the same frame, Fig. 34. Current flows through both coils. If the current flowing through each coil is the same, the needle centers; that's the condition which indicates proper exposure.

So, with the needle centered as in Fig. 35A, current #1 equals current #2. But consider what happens when current #1 is greater than current #2, Fig. 35B. The needle then moves up. And, when current #2 is greater than current #1, the needle moves down, Fig. 35C.

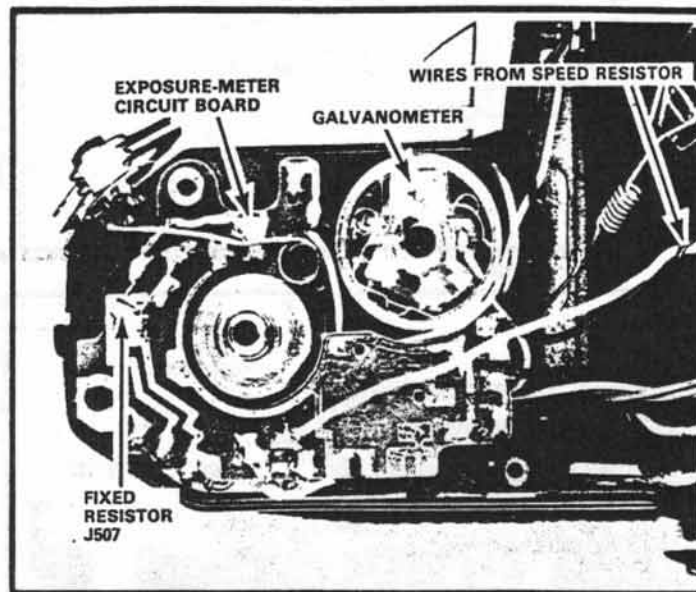

Figure 33

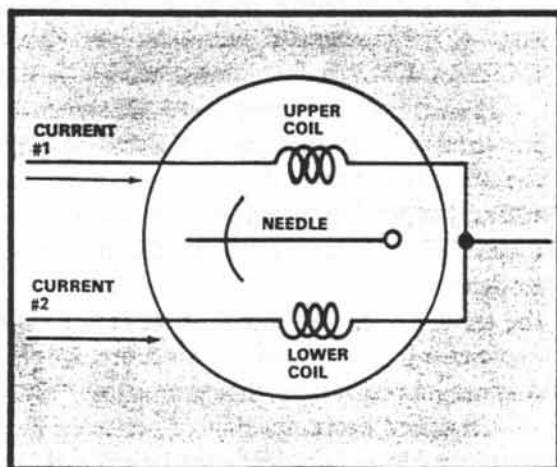

Figure 34

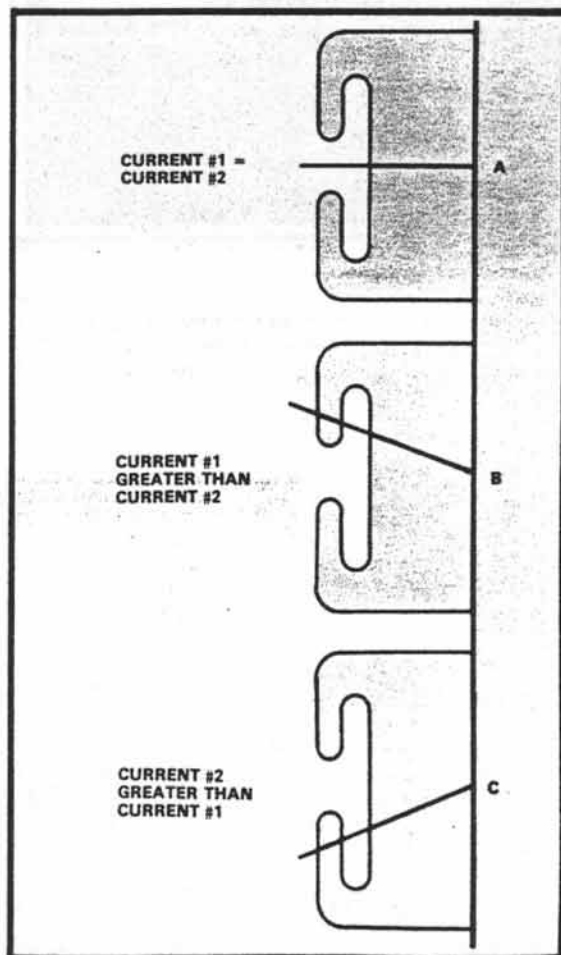

Figure 35

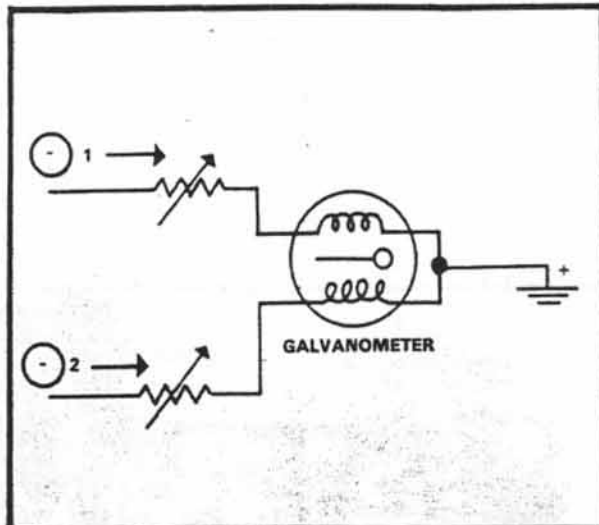

Figure 36

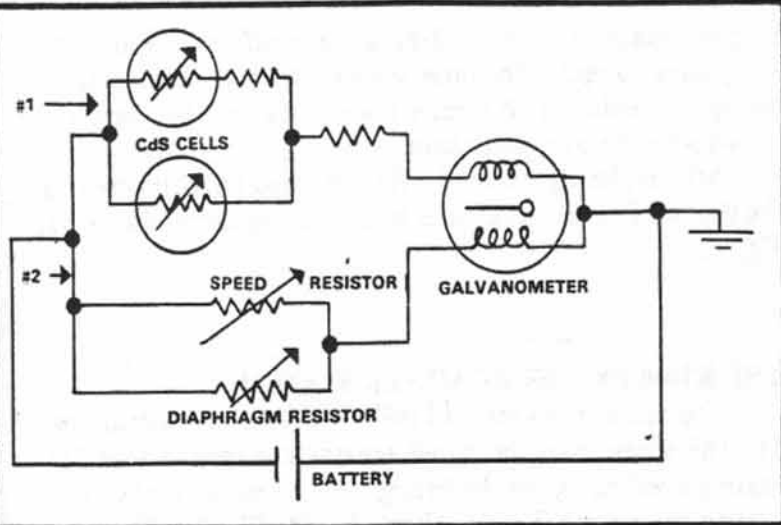

Figure 37

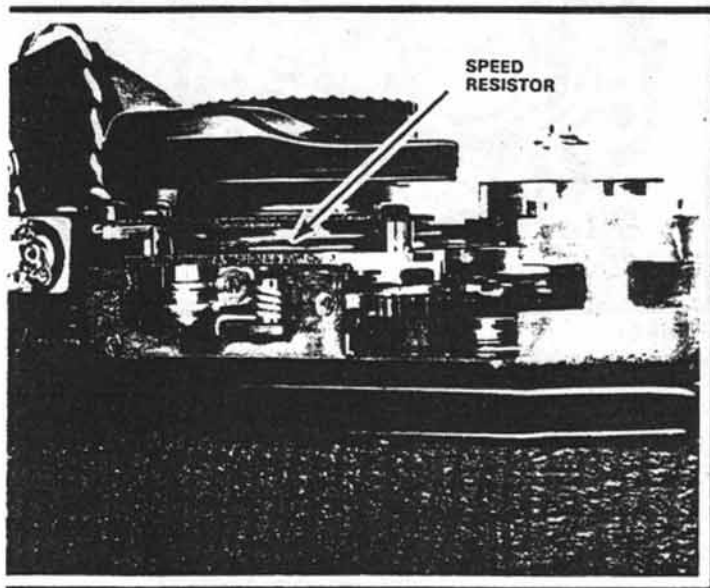

Figure 38

Fig. 36 puts the concept to work. Here, we've added a variable resistor in series with each galvanometer coil. Let's say there's more current flowing through path #1. What does the needle do? Right -- it moves up.

To center the needle, you can now use the variable resistors. You can either increase the resistance in path #1 or decrease the resistance in path #2. What you're doing is balancing the two current values until the current through path #1 equals the current through path #2.

You're doing the same thing when you set the camera's controls to center the needle. The CdS photocells control the resistance in path #1, Fig. 36. The shutter-speed, film-speed, and diaphragm controls set the resistance in path #2. So, as you change the controls, you're setting the resistance in path #2 to equal the light-controlled resistance in path #1.

Fig. 37 completes the circuit. The two photocells, connected in parallel, see the light falling on the focusing screen. As the light intensity increases, the resistance in path #1 decreases. Consequently, more current flows through path #1.

You must now decrease the resistance in path #2 to center the needle. The film-speed and shutter-speed settings program the resistance of the speed resistor in path #2; the speed resistor, you'll recall, sits under the speed knob, Fig. 38. The diaphragm opening programs the resistance of the diaphragm resistor, Fig. 37; remember, the diaphragm resistor sits behind the front standard.

Setting a smaller aperture decreases the resistance of the diaphragm resistor. Also, setting a slower film speed or a faster shutter speed decreases the resistance of the speed resistor.

Consider again that the light level has increased. The resistance of the photocells then decreases, sending more current through the upper galvanometer coil. As a result, the needle moves up -- you get the overexposure indication.

You must then set either the shutter speed or the diaphragm opening to center the needle. Since the light level has increased, you need a faster shutter speed to correct the exposure. And, as you've seen, setting a faster shutter speed

decreases the resistance of the speed resistor. More current flows through path #2, equalizing the two currents.

Or you can set a smaller f/stop to correct the overexposure indication. Setting a smaller f/stop decreases the resistance of the diaphragm resistor. So, once again, you've decreased the resistance in path #2 of the circuit.

A little later, we'll go through the actual troubleshooting steps for the circuit shown in Fig. 37. But from what you've seen so far, you should be able to draw some general conclusions. For example, suppose the needle always shoots to the top of the screen. You can then suspect a problem in path #2. If the needle always shoots to the bottom of the screen, you can suspect a problem in path #1.

What if the needle doesn't move at all? If the needle stays centered, there's no current in either galvanometer coil. Most likely, the circuit isn't getting power. Or perhaps the galvanometer itself is defective.

THE PHOTO SWITCH

You'll notice that the circuit of Fig. 37 has no on/off switch. Yet we mentioned earlier that the K1000 has an electronic on/off switch -- a switch that automatically turns off the meter when the light level drops below EV2 at ASA 100. Fig. 39 shows the electronic photo switch added to the basic circuit.

The photo switch adds only four components to the basic circuit -- a transistor, two bias resistors, and a third CdS cell. One of the bias resistors and the transistor mount to the underside of the exposure-meter circuit board. You can't as yet see

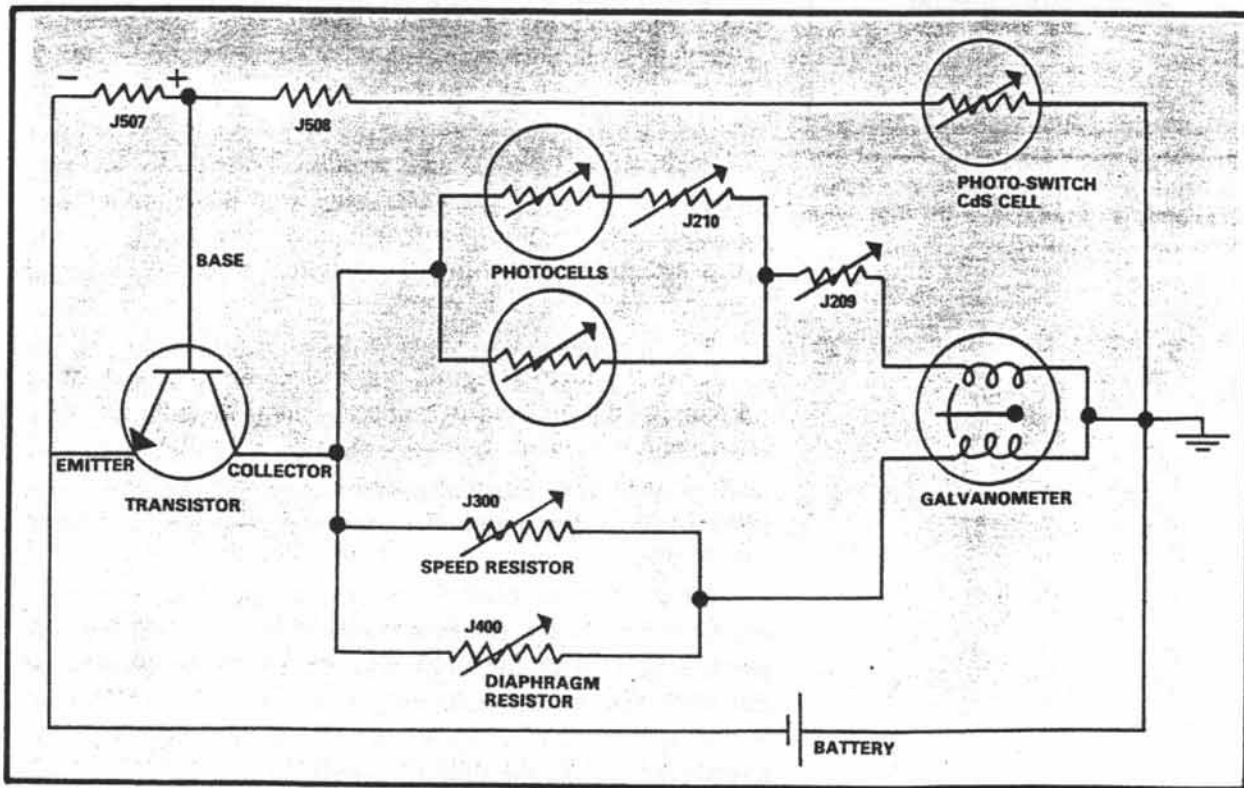

Figure 39

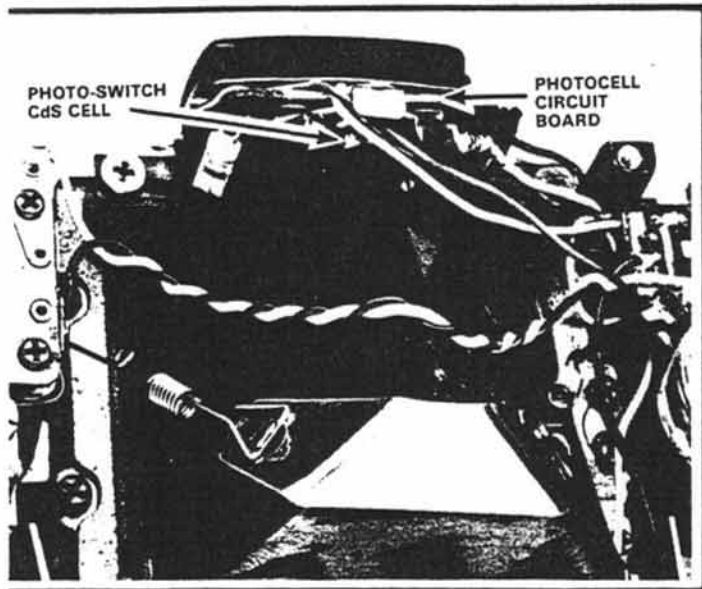

Figure 40

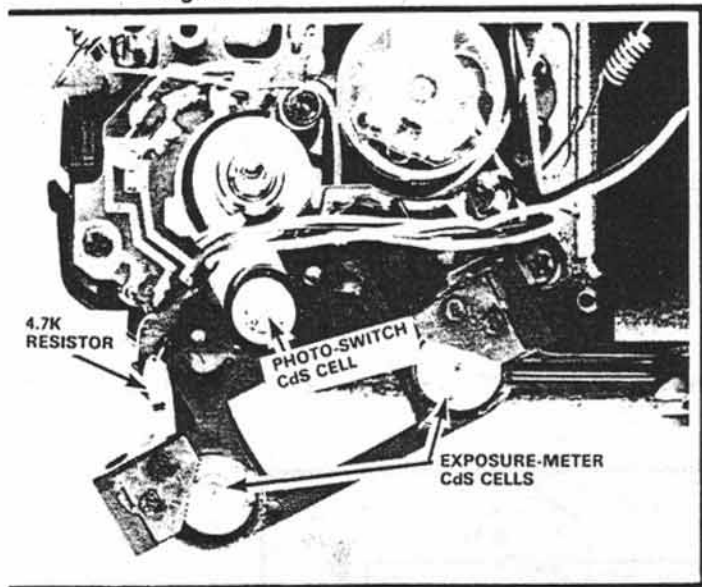

Figure 41

The 4.7K resistor is in series with the upper galvanometer coil (see page 42).

the transistor. But, as we'll cover in the next topic, you can reach the transistor's leads for troubleshooting purposes. The base-bias resistor -- J507 in Fig. 39 -- is at the top of the exposure-meter circuit board, Fig. 33.

You can see the remaining component of the photo switch -- the photo-switch CdS cell -- at the top of the photocell circuit board, Fig. 40. Like the other CdS cells, the photo-switch CdS cell sees the light falling on the focusing screen.

In Fig. 41, we've pulled aside the photocell circuit board to more clearly show the photo-switch CdS cell. Two screws behind the pentaprism hold the photocell circuit board. For most repairs, you can leave the photocell circuit board in place. However, if the camera has a defective CdS cell, you must replace the complete circuit-board assembly.

Current flowing through the photo-switch CdS cell also flows through resistor R1, Fig. 39. Notice that R1 connects between the base and emitter of the photo-switch transistor. The voltage drop across R1 then provides the forward bias that decides whether or not the transistor conducts current through the exposure-meter circuit.

Resistor R1, resistor R2, and the photo-switch CdS cell form a voltage divider across the battery. Normally, there's a sufficient voltage drop across resistor R1 to keep the transistor turned on. But, as the light level decreases, the resistance of the photo-switch CdS cell increases. Since more voltage then appears across the CdS cell, there's a smaller voltage drop across R1.

At a low enough light level, very little voltage appears across R1 -- too little to hold the transistor in conduction. The transistor then switches off. Turning off the transistor opens the current path to the exposure-meter circuit. But remember -- the light level must drop below EV2 at ASA 100 before the photo switch turns off the meter.

TROUBLESHOOTING THE K1000 EXPOSURE METER

The schematics we've been using for explanation purposes apply to several Spotmatic models which use basically the same exposure meter. But you will encounter variations in the different models. Fig. 42 shows the actual schematic for the K1000.

You'll notice in Fig. 42 that the photocell section of the circuit is slightly more complex than in our simplified schematics. Each of the two CdS cells has three leads. Also notice that both the speed resistor J300 and the diaphragm resistor J400 have fixed resistors in series connections. The fixed resistors are mounted underneath the exposure-meter circuit board.

Most of the troubleshooting procedures we'll now discuss apply to the other Spotmatic models using the two-coil galvanometer. Here, the K1000 provides a good representative. But when you're troubleshooting an exposure meter, it's best to use the schematic for the actual system -- use Fig. 42 for the K1000 (rather than the simplified schematics).

Earlier, we mentioned some of the tell-tale symptoms that can direct you toward the problem area. Here's a breakdown of the symptoms you might encounter:

1. the needle always remains centered
2. the needle always shoots to the top of the screen
3. the needle always shoots to the bottom of the screen
4. the needle position doesn't change when you set the f/stop
5. the needle position doesn't change when you set the shutter speed.

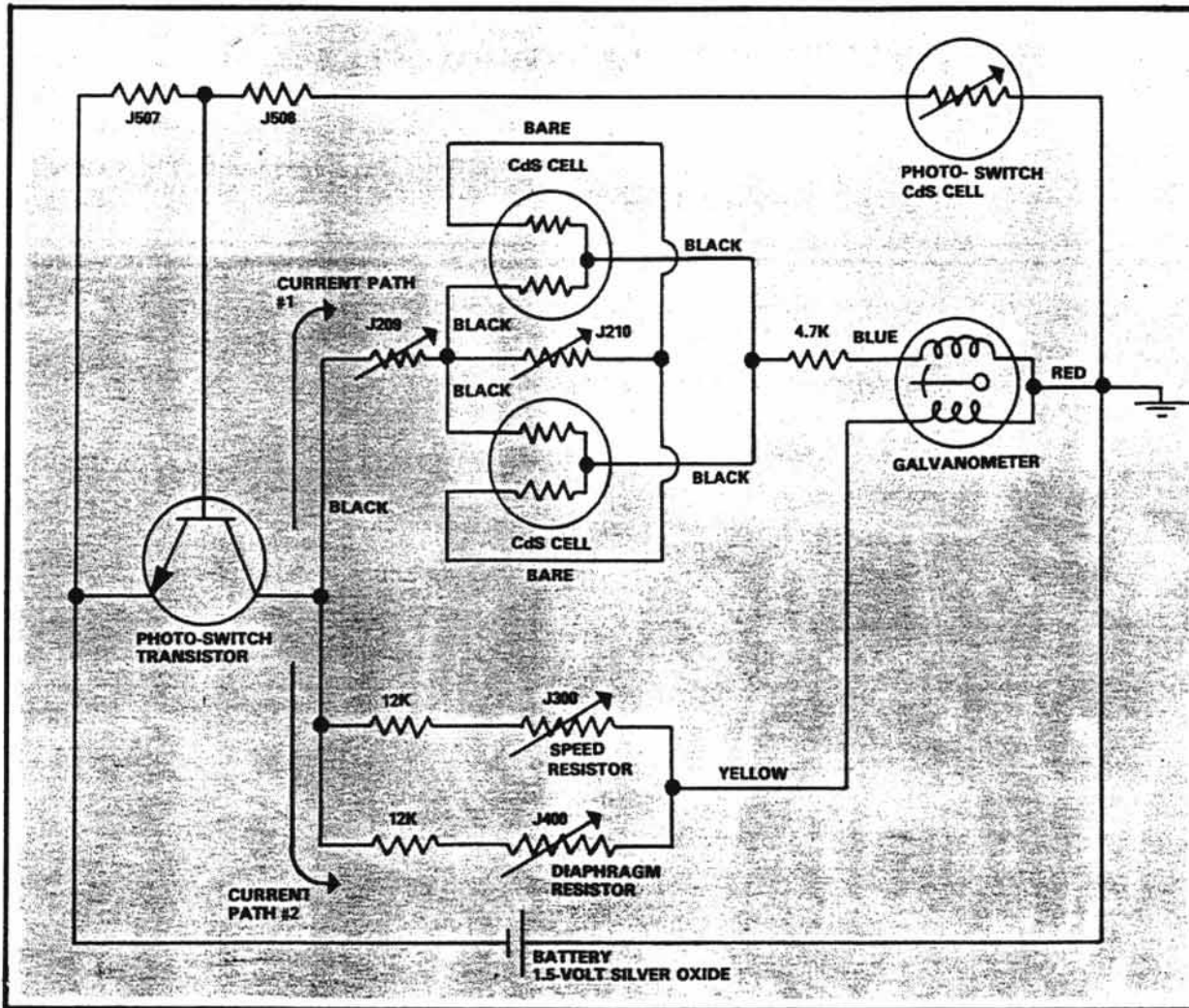

Figure 42

Let's start by saying that the needle always remains centered -- regardless of the light conditions. What's your first suspect? *It should be the battery.* Remember to check the battery as your first step in troubleshooting any CdS-type meter.

NOTE: You removed the battery with the bottom cover. So, to test and adjust the exposure meter, you must replace the bottom cover and the battery.

Even with a fresh battery, though, it's possible that the voltage isn't reaching the exposure-meter circuit. You can then make your first tests using a voltmeter -- make sure you're getting the proper voltages to the circuit boards.

Notice in Fig. 42 that the positive side of the battery connects to ground -- the camera body. A screw and washer make the ground connection between the camera body and the exposure-meter circuit board, Fig. 43. The screw holds the ground washer in firm contact with the ground land.

Since the camera has a positive ground, *all your voltage measurements will be negative* (with respect to ground). Touch your positive voltmeter probe to the ground land, Fig. 43. Then, touch your negative voltmeter probe to the test points on the circuit boards.

Check first for the battery voltage. A black wire, Fig. 43, connects the negative battery terminal to the exposure-meter circuit board. With the battery installed, measure the voltage between the ground land and the black-wire land, Fig. 43. You should measure the full battery voltage (around 1.57 volts with a new battery).

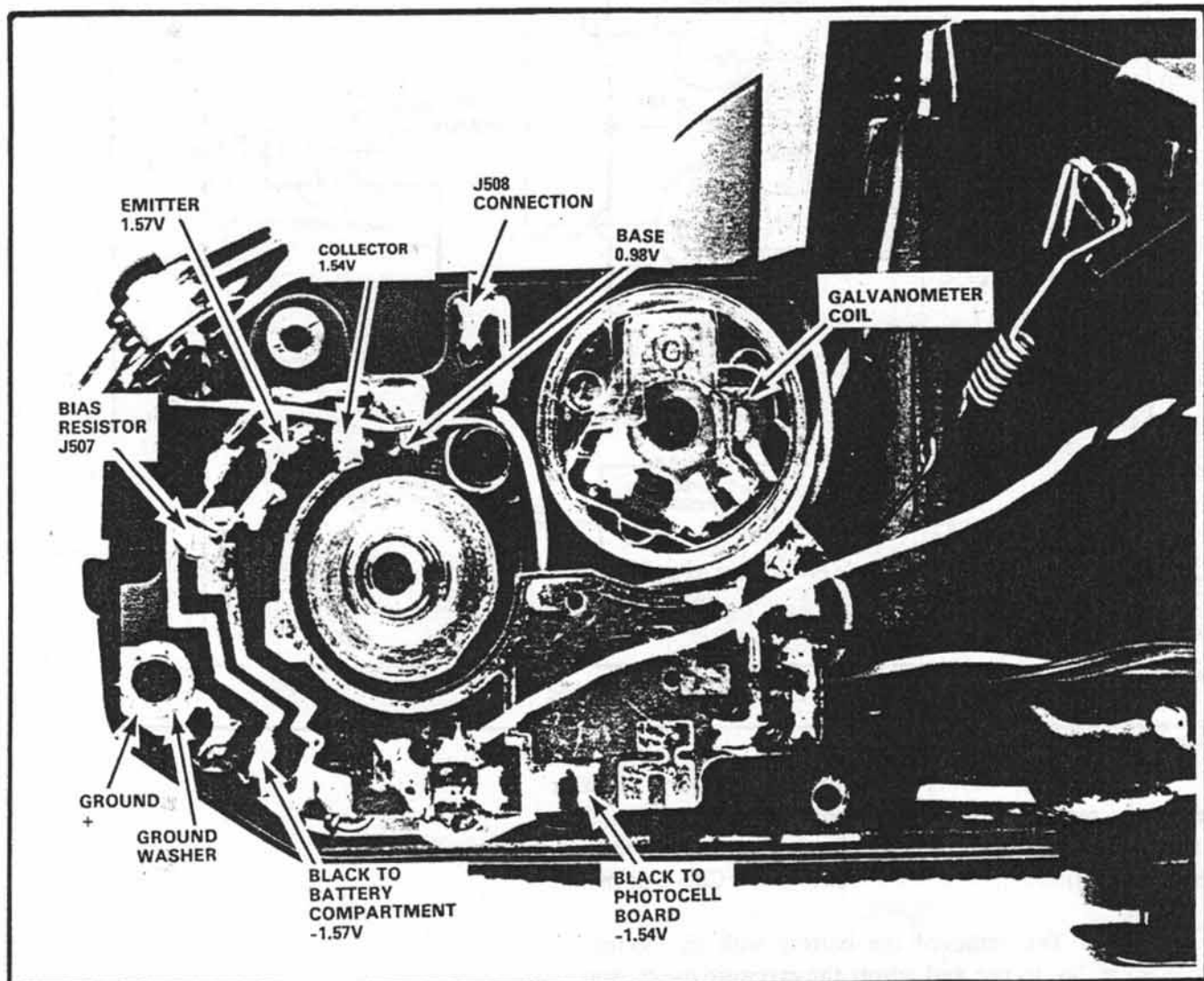

Figure 43

The ground system used in the K1000 is typical of many camera designs. A washer makes the connection between the camera body and the ground contact of the circuit board. There's no solder connection. Rather, the circuit relies on the pressure of the washer to make a good electrical connection to the camera body.

With this type of system, the ground connection should be one of your first suspects when you aren't getting a complete circuit. Try removing the ground screw and washer. Then, clean the washer and the ground land, Fig. 43, to assure good electrical contact. Also, make sure that the ground screw is snugly tight.

What else could cause the problem? If the battery voltage isn't reaching the exposure-meter circuit board, the problem could be with the black wire, Fig. 43. The black wire, you'll recall, connects the exposure-meter circuit board to the negative battery terminal.

So, if one end of the black wire is disconnected or has a poor solder connection, the meter doesn't have a complete circuit. You can check the continuity of the black wire by using an ohmmeter. Remove the battery. Then, check for continuity between the black-wire land, Fig. 43, and the negative battery terminal.

Retouching the solder connections at both ends of the black wire often corrects an apparent open. You can reach one end of the black wire at the exposure-meter circuit board, Fig. 43. But you'll have to take out the three screws and lift aside the battery compartment to reach the other end.

NOTE: The current Spotmatic models have stainless-steel battery terminals. It's difficult to solder a wire to a stainless-steel contact. But you can use a conductive adhesive such as conductive epoxy.

Also check for corrosion on the negative battery terminal in the battery compartment. Current Spotmatic models have stainless-steel battery terminals. Consequently, corrosion isn't that much of a problem; you can clean off corrosion by using a contact cleaner. However, if you're working on an older camera, you may find that the corrosion has damaged the negative battery contact. In that case, you should replace the complete battery compartment. Since the replacement part has the stainless-steel contact, your customer isn't as likely to encounter another problem with corrosion.

Now, let's say that you are getting the battery voltage to the exposure-meter circuit board. Where do you check next? Try measuring the voltage between the ground land and the

collector of the transistor, Fig. 43. You should measure very close to the full battery voltage. When conducting, the transistor only drops a fraction of a volt.

If you measure 0 volt at the collector, the transistor isn't conducting. There could be a problem in the bias circuit. Or the transistor itself could be defective.

You can make a quick test of the transistor by using your tweezers to short between the emitter and collector leads, Fig. 43. The short bypasses the transistor. So, if the needle now moves, you've isolated the problem to the photo-switch circuit.

Fig. 43 also shows the other approximate voltages you should measure in the photo-switch circuit. Again, these voltage measurements assume a fresh battery. If you aren't getting the proper voltage readings -- and if shorting across the transistor turns on the meter -- you know that the problem is in the photo-switch circuit.

The problem could be an open transistor, an open photo-switch CdS cell, or an open bias resistor. A poor solder joint could also cause the problem. So you might first try retouching the solder joints on the exposure-meter circuit board. Retouch the connections for the transistor, for the base-bias resistor J507, and for resistor J508, Fig. 43.

CAUTION: If you do retouch the transistor leads, be careful to avoid overheating the transistor. The transistor will be damaged by too much heat.

Touch your soldering iron to the leads just long enough for the solder to flow. Avoid holding the soldering iron on the leads too long. Here's one place you want to get on and off the solder joint quickly.

A poor solder joint is more common than is a defective component. That's fortunate -- the components mounted to the exposure-meter circuit board come as a complete assembly. So, if you find an open transistor, you replace the exposure-meter circuit board. Similarly, if the photo-switch CdS cell is open, you replace the complete photocell circuit board. But replacing circuit boards isn't a common repair. So we'll wait a moment to describe the procedure.

Consider first that you are getting the proper voltage at the collector lead, Fig. 43. Yet the needle still doesn't deflect. There could be an open between the collector lead and the CdS cells, Fig. 42.

A black wire connects the photocell circuit board, Fig. 44, to the collector lead, Fig. 43. The red wire shown in Fig. 44 connects to the ground land on the exposure-meter circuit board, Fig. 43. Check the voltage between the red ground wire (+) and the black wire (-), Fig. 44. Your voltage reading here should be the same as your measurement at the collector land, Fig. 43.

If you aren't getting the operating voltage at the photocell circuit board, look for a disconnected wire or a bad solder connection. Try retouching the solder connections at both ends of the red wire and of the black wire, Fig. 43 and Fig. 44.

Earlier, we mentioned that you can quickly check for a problem in the photo-switch circuit by shorting across the transistor, Fig. 43. You can make a similar shorting test to distinguish between a defective transistor and a defective photo-switch CdS cell.

For example, consider that the needle doesn't move. Yet, when you short across the photo-switch transistor, the needle deflects properly. You now know that there's a problem in the photo-switch circuit. But which component is at fault -- the transistor or the photo-switch CdS cell?

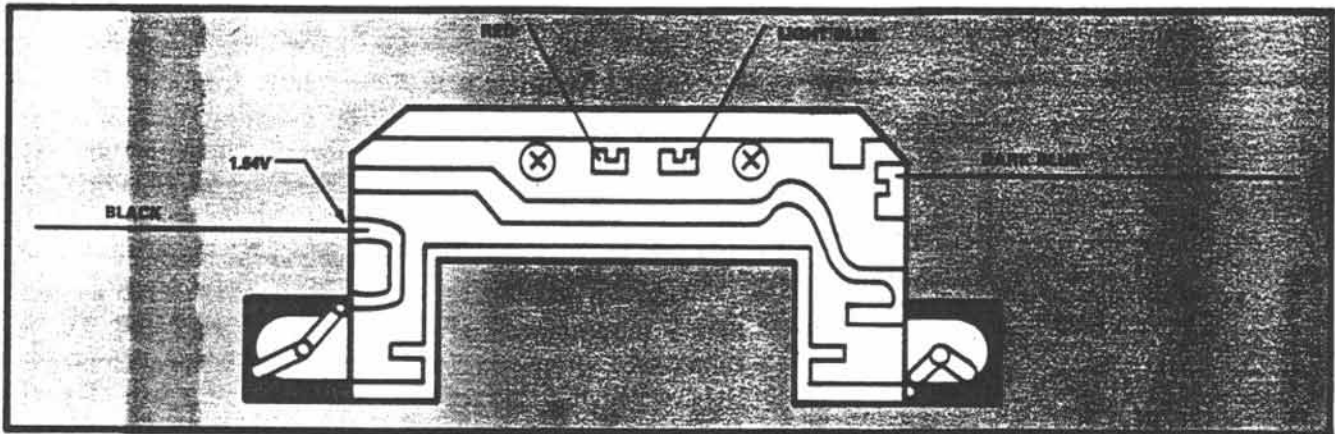

Figure 44

You can find out quickly by using your tweezers to short across the photo-switch CdS cell -- between the red-wire land and the light-blue-wire land in Fig. 44. If the needle now deflects, the problem is most likely an open CdS cell. And if the needle still doesn't deflect? Then, you probably have a defective transistor.

CHECKING THE GALVANOMETER

What else could cause the galvanometer needle to remain centered? It's unlikely that both current paths, Fig. 42, would be open. However, there may be an open inside the galvanometer.

Notice in Fig. 42 that the red galvanometer wire is common to both coils. So, if the needle won't move in either direction, the red-wire connection inside the galvanometer may be defective. Or both coils could be open.

The dark-blue wire connects to the upper galvanometer coil, Fig. 42. A defective connection here would prevent the needle from moving toward the top of the screen (even though the needle could still move down). Or, if the needle won't move up, the upper galvanometer coil may be open. Similarly, if the lower coil is open or if the yellow-wire connection is defective, the needle won't move down.

Regardless of the malfunction -- a defective connection or an open coil -- your most economical repair is to replace the

complete galvanometer assembly. But you should first check the galvanometer to make sure it's at fault. You can check the galvanometer by running current directly through the individual coils.

Yet you have to be careful when checking the galvanometer -- you don't want to put too much current through the coils. Typically, you use an ohmmeter to check a galvanometer coil. A conventional ohmmeter, though, puts out too much current. That current could peg the needle, causing damage. Or it could mislead you as to the problem.

How? Consider that the upper galvanometer coil has an open. You then check for the continuity of the coil by connecting your ohmmeter between the red-wire connection and the blue-wire connection, Fig. 42. You're now running current directly through the upper coil. And, even though the coil originally had an open, you may find that the needle moves up.

What's happened is that the current from the ohmmeter has "welded" the open coil. So the galvanometer now works. However, the repair is only temporary. The temporary weld will soon fail -- probably after the customer has been using the camera for a few days. Your ohmmeter test has then misled you into thinking that you've corrected the problem.

Here's a safe way to test the galvanometer: run no more than 3 microamperes of current through each coil. Fig. 45 shows a test set-up you can use with a conventional ohmmeter. Here, we've disconnected the red galvanometer wire, Fig. 46. And we've hooked the positive ohmmeter lead to the red wire, Fig. 45.

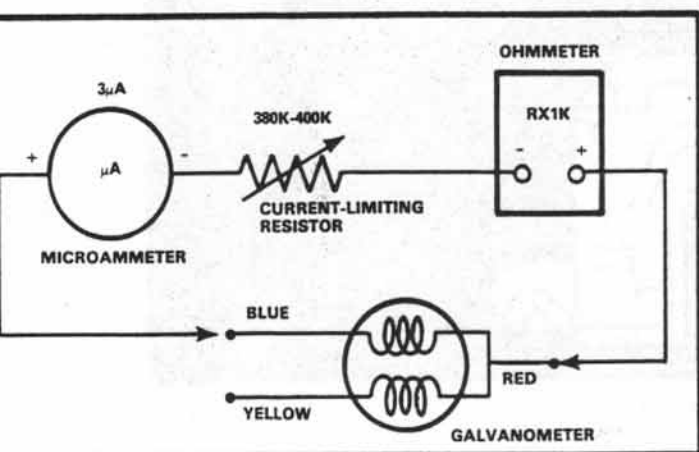

Figure 45

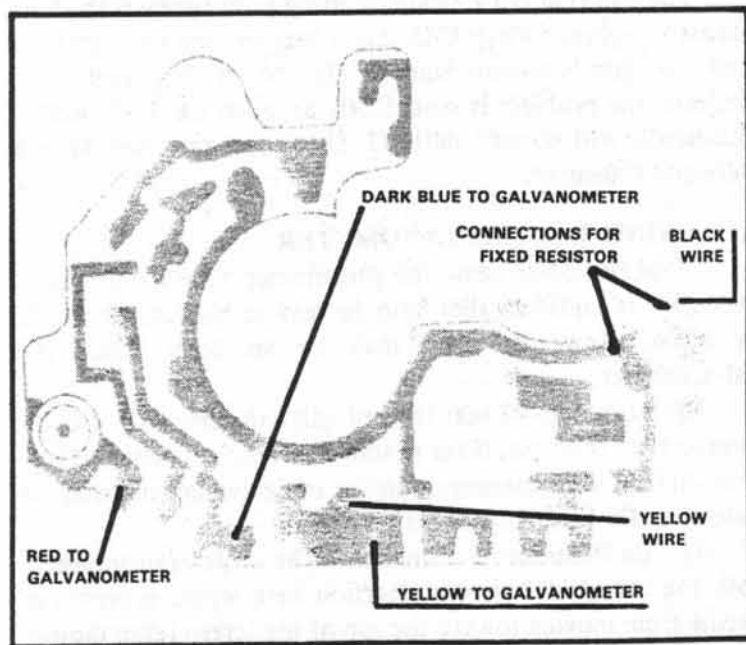

Figure 46 Exposure-meter circuit board

But we've connected a variable current-limiting resistor in series with the other ohmmeter lead. With the current-limiting resistor set to around 390K -- and with the ohmmeter set to the R X 1K scale -- you'll get a safe current value.

Connect a lead to the other end of the current-limiting resistor. Then, touch your test lead to either the blue galvanometer wire or to the yellow galvanometer wire, Fig. 45. You're now running around $3\mu\text{a}$ directly through a galvanometer coil.

If you run current through the upper coil, Fig. 45, the needle should move up slightly. Running current through the lower coil should cause the needle to move down slightly. You should also get a reading on the ohmmeter -- the resistance of the coil (around 1.3K) plus the resistance of your variable resistor. A reading of infinite ohms indicates an open coil or a defective connection.

CHECKING THE SPEED RESISTOR

A defective speed resistor could cause the needle to peg to the bottom of the screen. Or, you may find there's no change in the needle position as you change the shutter speed and film speed -- even though the needle works properly when you change the light level and diaphragm setting.

If the needle doesn't move when you change shutter speeds, first check the speed resistor. Unsolder the yellow wire, Fig. 46, from the exposure-meter circuit board. Then, measure the resistance between the yellow wire and the black wire, Fig. 46.

The resistance should increase as you set slower shutter speeds or faster film speeds. For example, with the film speed set to ASA 100, you should measure around 1K at 1/1000 second; you should measure around 50K at the 1-second setting.

Suppose, then, that the speed resistor checks out properly. Yet you still note the same problem -- the needle position doesn't change as you rotate the speed resistor. What else could cause the malfunction?

Referring to the schematic, Fig. 42, you can locate another possible cause. Perhaps there's a problem with the fixed resistor which connects in series with the speed resistor. If the fixed resistor is open, the effect is the same as an open speed resistor.

Fig. 46 points out the fixed-resistor lands on the exposure-meter circuit board (the fixed resistor connects to the underside of the board). It's possible that the only problem is poor solder connections. Try retouching the two solder connections for the fixed resistor, Fig. 46, as well as the solder connections for the speed-resistor wires.

If retouching the solder joints doesn't correct the problem, check the fixed resistor. Just unsolder the black wire coming from the speed resistor, Fig. 46. Then, measure the resistance between the two fixed-resistor lands shown in Fig. 46. You should measure close to the indicated resistance (12K) in Fig. 42. If you read an open, you must replace the fixed resistor or the complete exposure-meter circuit board; we'll describe the procedure a little later.

CHECKING THE DIAPHRAGM RESISTOR

A defective diaphragm resistor results in a similar malfunction. This time, though, you may find that the needle moves as you change the shutter speed. But it doesn't move as you change the diaphragm setting.

Fig. 47 shows the positions of the two wires coming from the diaphragm resistor. Since you can reach the wires from the top of the camera, you can test the diaphragm resistor without removing the front standard.

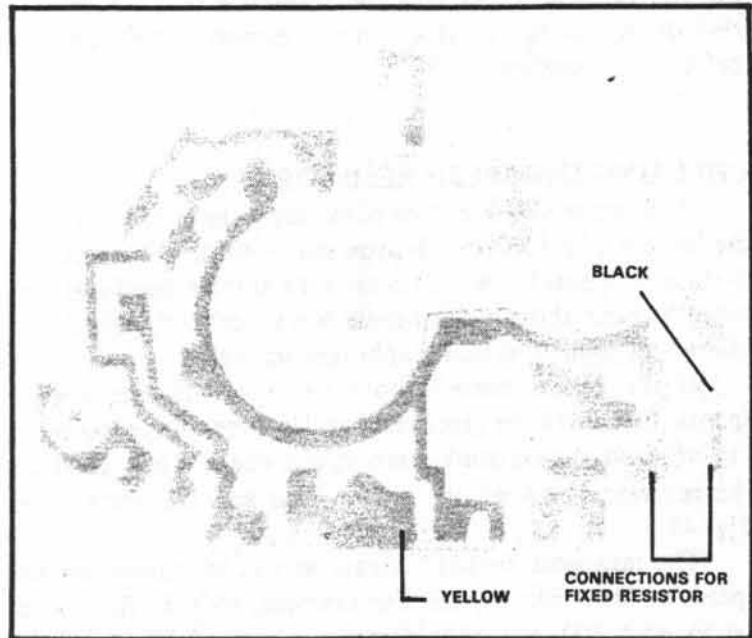

Figure 47 Exposure-meter circuit board

NOTE: In Fig. 47, we've just indicated the positions of the diaphragm-resistor wires. However, the circuit-board land for the yellow wire actually has three yellow wires — one for the speed resistor, one for the galvanometer, and one for the diaphragm resistor.

Unsolder the black wire, Fig. 47, from the exposure-meter circuit board. Then, clip one of your ohmmeter leads to the disconnected black wire; touch the other ohmmeter lead to the circuit-board land containing the three yellow wires. With the lens removed, you should read a resistance of around 2K.

Continue watching the ohmmeter as you turn the diaphragm-metering ring, Fig. 6, in a clockwise direction. The resistance should increase smoothly. When the diaphragm-metering ring reaches the fully clockwise position, you should read a resistance of around 150K.

If you read an open -- or if the resistance change appears erratic -- you'll have to remove the front standard to reach the diaphragm resistor. We'll describe the procedure in a later topic. But first, let's say the diaphragm resistor checks properly. Yet you still get the symptoms of a defective diaphragm resistor.

Checking the schematic, Fig. 42, should give you another clue as to the possible problem. As with the speed resistor, there's a fixed resistor connected in series with the diaphragm resistor. Again, the problem may be as simple as poor solder connections.

Fig. 47 points out the lands for the fixed resistor. Try retouching the solder connections on these two lands. If retouching the solder connections doesn't correct the problem, check the fixed resistor. Just leave the black wire of the diaphragm resistor disconnected. And measure the resistance between the two fixed-resistor lands, Fig. 47.

REMOVING THE EXPOSURE-METER CIRCUIT BOARD

As we indicated earlier, it's unusual to have to replace the exposure-meter circuit board. However, you'll have to pull aside the exposure-meter circuit board for certain repairs.

First, lift the rewind shaft to open the camera back. Then, note the position of the rewind-shaft detent spring, Fig. 48. The long end of the detent spring hooks to a spring-hooking screw. The short end passes through a slot in the rewind-shaft housing.

The short end of the detent spring rides against the side of the rewind shaft. When you pull up the rewind shaft, the detent spring drops into a rewind-shaft slot; the detent spring then holds the rewind shaft in the raised position. The detent spring drops into another rewind-shaft slot when you push down the rewind shaft.

Removing the detent spring allows the rewind shaft to drop out (toward the bottom of the camera). Disconnect the long end of the detent spring from the spring-hooking screw, Fig. 48. Then, lift out the detent spring and remove the rewind shaft.

Next, unscrew the top-cover support post which holds one end of the exposure-meter circuit board, Fig. 48. Also remove the ground screw and washer shown in the same illustration. The washer comes against the ground land on the exposure-meter circuit board to assure a good ground connection.

You can now lift aside the exposure-meter circuit board, Fig. 49. In Fig. 49, you can see the transistor, the second bias resistor, and the two fixed resistors mentioned earlier. What if you have to replace the exposure-meter circuit board, perhaps

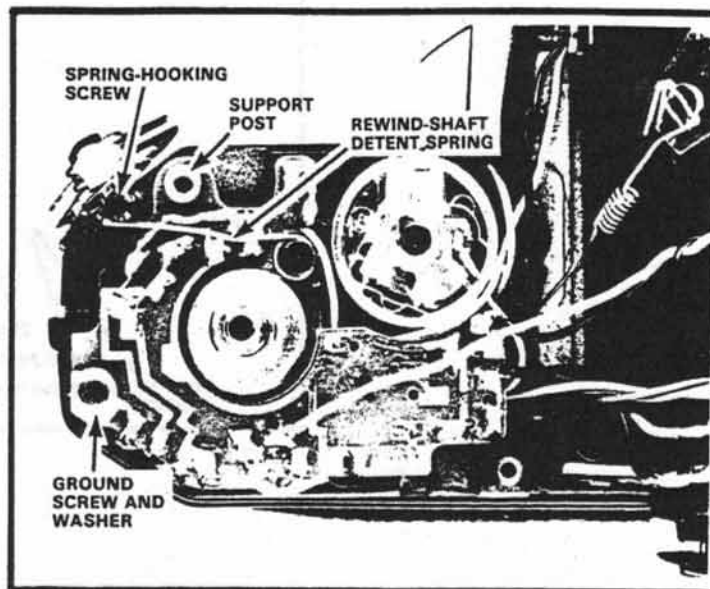

Figure 48

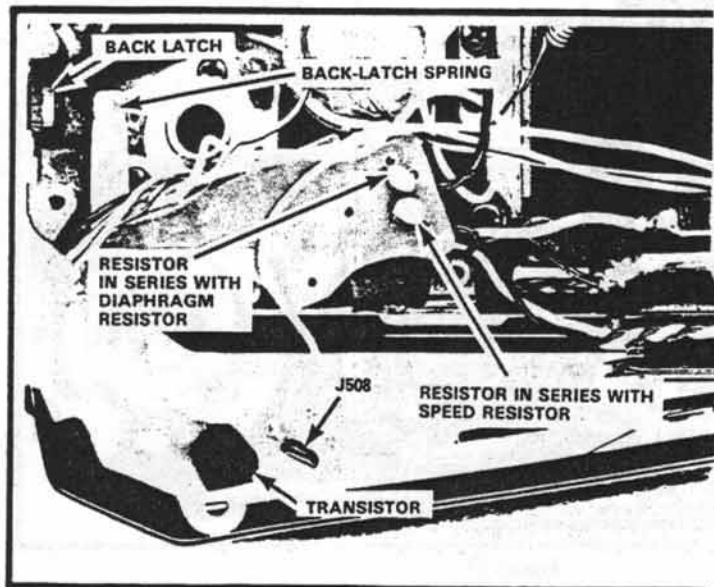

Figure 49

With the rewind shaft removed, you can still open the camera back. Just pull up the back latch shown here.

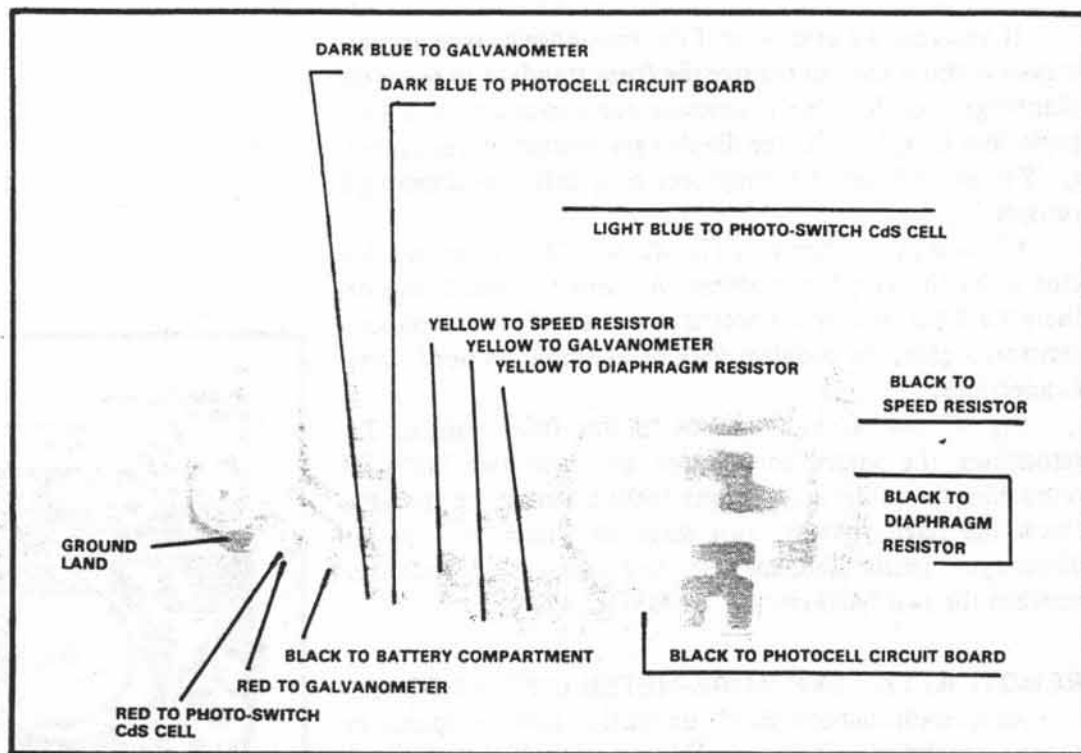

Figure 50

for a defective transistor? Then, you must unsolder all the wires. Fig. 50 shows the wire connections to the exposure-meter circuit board.

Do not attempt to replace the two transistor-bias resistors J507 and J508. The resistor values vary according to the particular transistor. If either resistor is defective, replace the complete exposure-meter circuit board.

However, you can replace the 12K resistors (the one in series with the speed resistor or the one in series with the diaphragm resistor). Pentax doesn't supply the resistors individually as replacement parts. But, if you replace an exposure-meter circuit board, you can save the two 12K resistors from the old board.

REPLACING THE SPEED RESISTOR

Let's say that your troubleshooting procedure has pinpointed a problem to the speed resistor, the diaphragm resistor, or the galvanometer. You can remove and replace any one of these units without disturbing the other two.

To replace the speed resistor, first remove the speed knob. A replacement speed resistor comes with no wires. So, if you know you have to replace the speed resistor, leave the wires connected to the exposure-meter circuit board. Instead, disconnect the two wires from the speed resistor. The yellow wire connects to the brush that engages the contact ring, Fig. 51. The black wire connects to the end of the resistor ring (we'll cover the operation of the speed resistor in a moment).

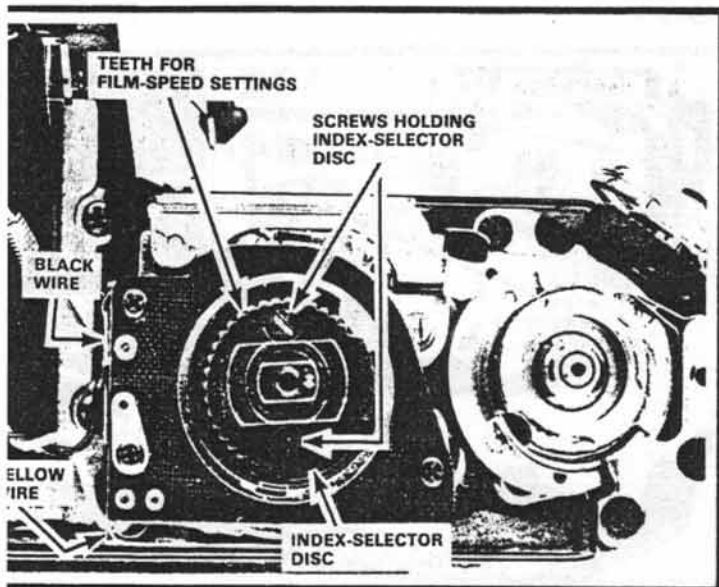

Figure 51

Notice that the teeth of the index-selector disc are opposite the timing dimple on the speed selector. That's true regardless of the shutter-speed setting. So you can replace the index-selector disc at any shutter speed; just make sure the teeth are opposite the timing dimple.

Note the position of the index-selector disc at the bulb setting, Fig. 46. The teeth of the index-selector disc face the pentaprism. A lug on the underside of the speed knob engages the teeth of the index-selector disc according to the film-speed setting.

Remove the two screws holding the index-selector disc, Fig. 51. You'll then notice that the screw holes in the index-selector disc are countersunk; that allows the screwheads to sit flush with the top surface of the index-selector disc. On reassembly, make sure you seat the index-selector disc with the countersunk ends of the screw holes facing up.

Now, lift off the index-selector disc. Also lift off the speed-resistor turning ring, Fig. 52. Remember, the large tab of the speed-resistor turning ring passes into a speed-knob slot. But there's a smaller tab on the other side of the speed-resistor turning ring. The smaller tab passes into the slot of the contact ring, Fig. 53.

The rest of the speed-resistor assembly comes out as a unit. Take out the three screws holding the fiber board (you'll have to partially advance the wind lever to reach one of the screws). Then, lift out the speed-resistor assembly. Watch for a loose washer which sits under the speed resistor.

Looking at the bottom of the speed resistor, you can see the contact ring, Fig. 54. This is the ring that turns when you rotate the speed knob. The yellow wire connects to a brush which rides against the contact ring.

The actual resistance element is on the back of the fiber circuit board, Fig. 54. You can just see the black resistor ring under the contact ring. A brush on the underside of the contact ring rides against the resistor ring.

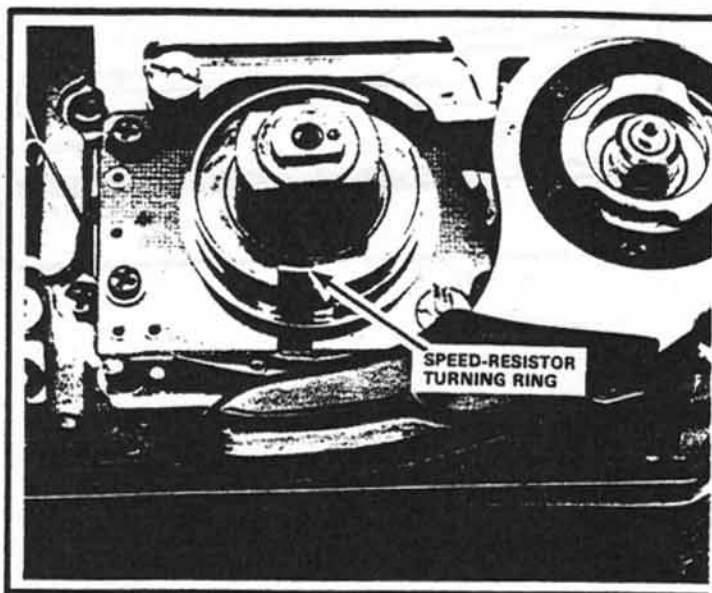

Figure 52

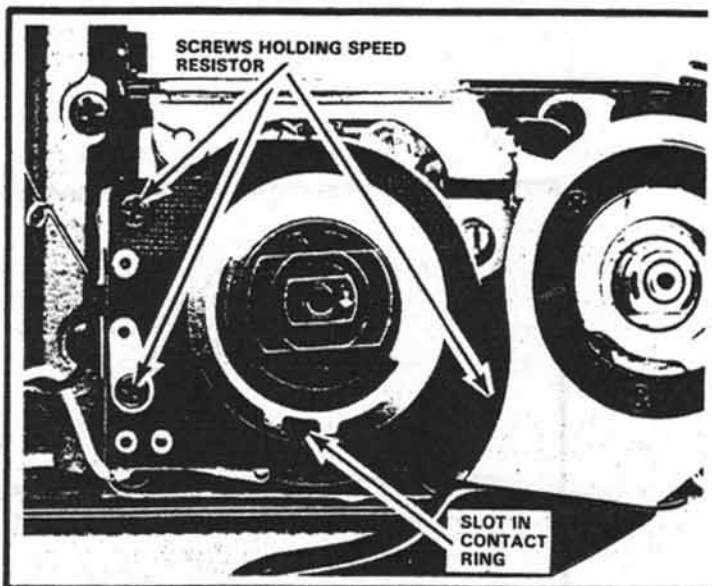

Figure 53

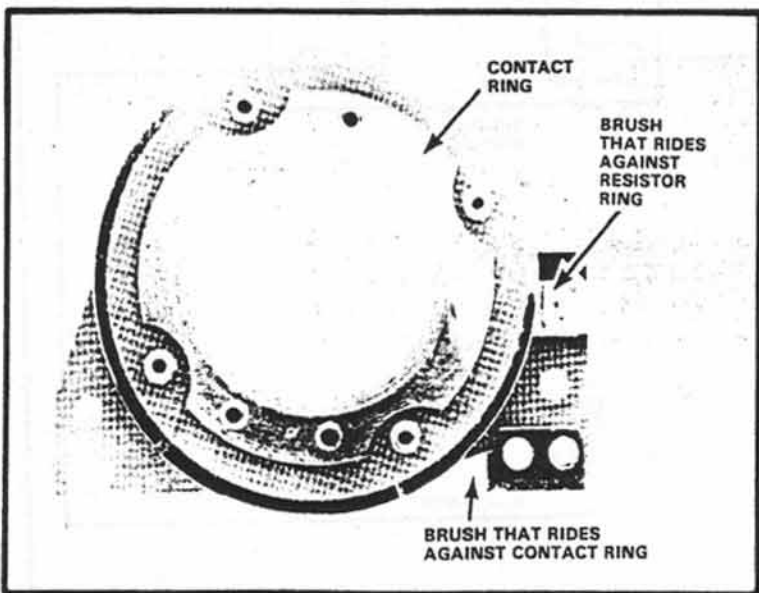

Figure 54 Bottom of speed resistor

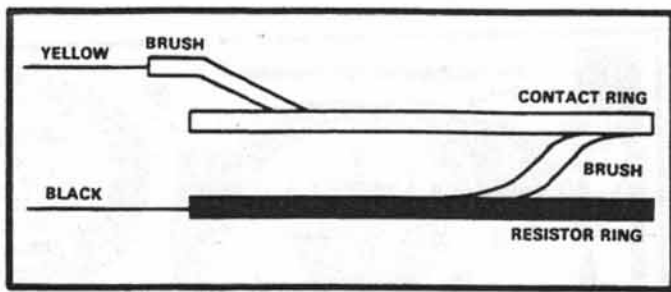

Figure 55

Another brush rides against the contact -- that's the brush pointed out earlier (the one that connects to the yellow wire). The pictorial, Fig. 55, shows how the speed resistor works. Notice that the black wire connects to the resistor ring. As you rotate the contact ring, you're just changing the length of the resistance path between the black wire and the yellow wire.

Erratic resistance readings -- or, for that matter, even an open -- could be the result of poor brush contact. You might then try cleaning the brushes and the resistor ring by using a contact cleaner. But if cleaning the speed resistor doesn't solve the problem, you'll have to replace the complete speed-resistor assembly, Fig. 54.

REMOVING THE DIAPHRAGM RESISTOR AND THE FRONT STANDARD

To reach the diaphragm resistor, you'll have to remove the front standard. There are only two wires to unsolder -- the black wire and the yellow wire that go to the diaphragm resistor.

The black wire and the yellow wire at the exposure-meter circuit board, Fig. 56, connect to a terminal board at the back of the front standard. Another pair of wires, also connected to the terminal board, go to the diaphragm resistor.

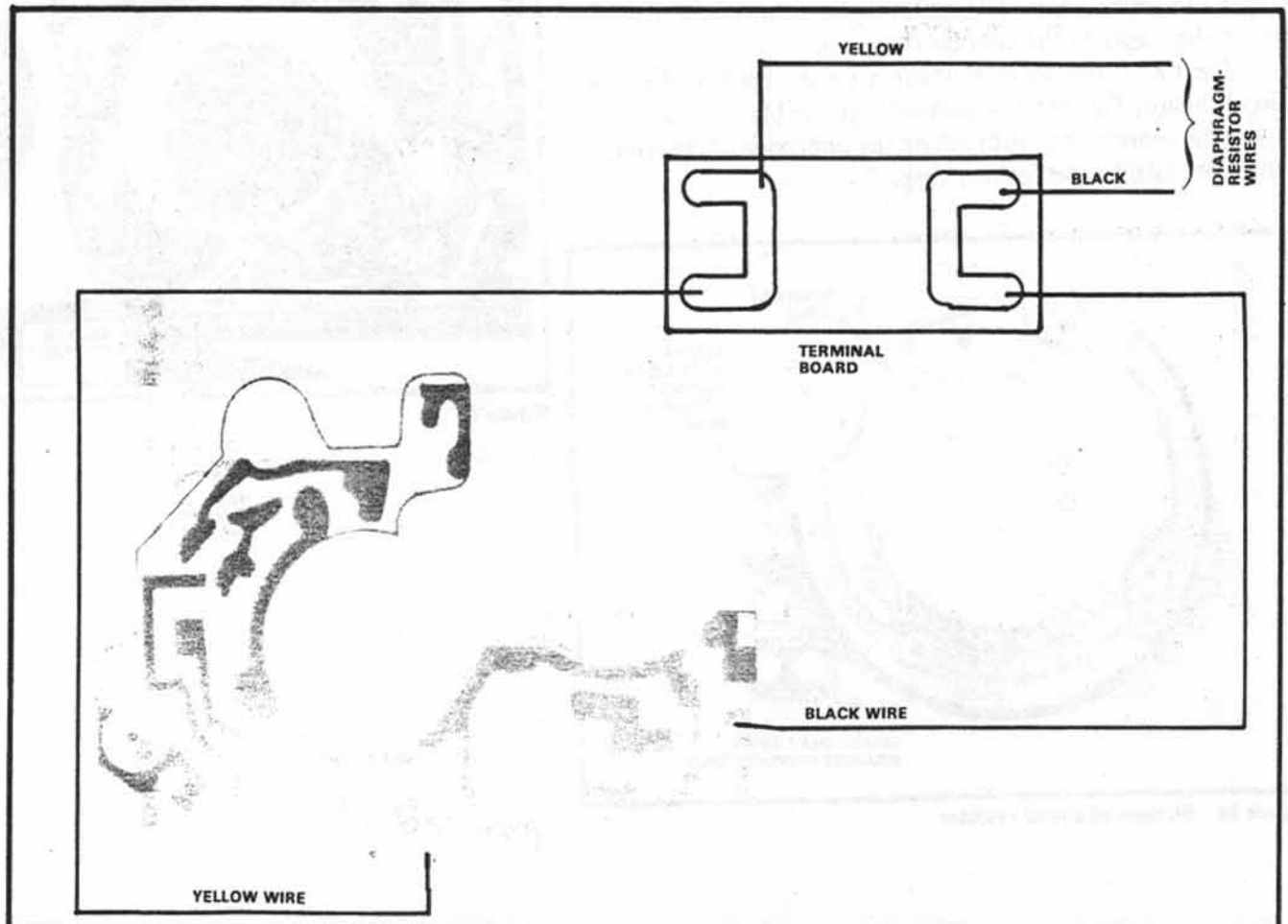

Figure 56 Exposure-meter circuit board

As you can see in Fig. 56, you have a choice as to where you disconnect the two wires. You can unsolder the two wires from the exposure-meter circuit board, Fig. 56, before removing the front standard. Or you can pull aside the front standard and unsolder the two wires from the terminal board.

Let's now consider that you have only one reason for pulling the front standard -- you want to replace or repair the diaphragm resistor. In that case, you only need to unsolder the diaphragm-resistor wires, Fig. 56, from the terminal board; it's not necessary to unsolder the lead wires connecting the terminal board to the exposure-meter circuit board. You can then wait until you've pulled aside the front standard before you do any unsoldering.

Peel off the leatherette from both sides of the front standard. You can now reach the five front-standard retaining screws, Fig. 57.

But notice that each of the front-standard retaining screws passes through a screw-mount bushing, Fig. 58. The screw-mount bushings provide your adjustment points for the flange-focal distance and for the parallelism.

After loosening the front-standard screw, you can turn the threaded bushings. Turning the threaded bushings clockwise increases the flange-focal distance; turning the threaded bushings counterclockwise decreases the flange-focal distance. The proper flange-focal distance for the Spotmatic is 45.46mm (that's the distance measured from the front surface of the lens-mounting ring to the film-guide rails). If the parallelism is correct -- yet the flange-focal distance is incorrect -- you can turn each of the threaded bushings the same amount.

Yet you normally don't want to disturb the positions of the threaded bushings. So, before removing the front-standard screws, you might take a precaution to avoid losing the adjusted positions -- *either scribe the threaded bushings or use a little lacquer to lock the threaded bushings in place.*

Scribing or locking the threaded bushings assumes that the adjustments are correct. However, it's possible that the adjustments for the parallelism and the flange-focal distance have been disturbed by impact damage. So, as a general rule, you should measure the flange-focal distance after reassembly.

There's one other caution -- *you'll find a loose tapered bushing under each of the front-standard screws.* The tapered bushings lock the positions of the threaded bushings. Also, notice that one of the front-standard screws is smaller than are the others, Fig. 57. Under the smaller screw, you'll find a smaller tapered bushing and a smaller threaded bushing.

Now, remove each of the five front-standard screws, Fig. 57. And lift out each of the five tapered bushings, Fig. 59. Be careful to avoid pulling loose the diaphragm-resistor wires as you lift aside the front standard.

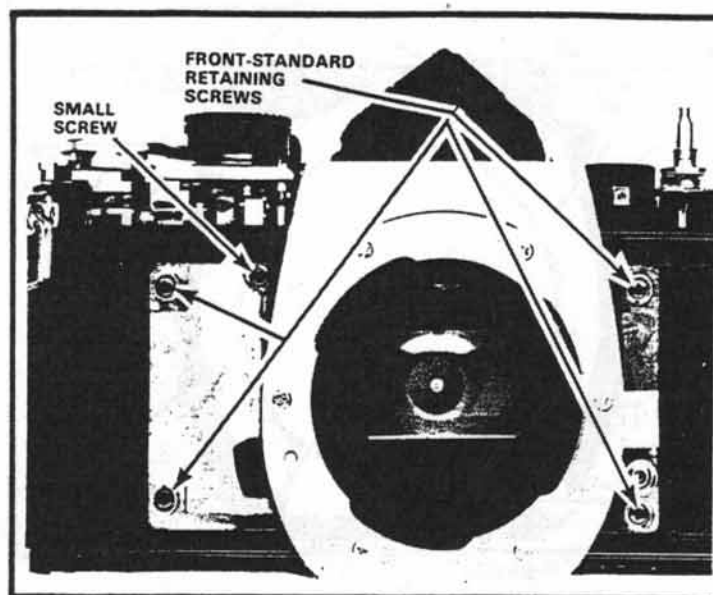

Figure 57

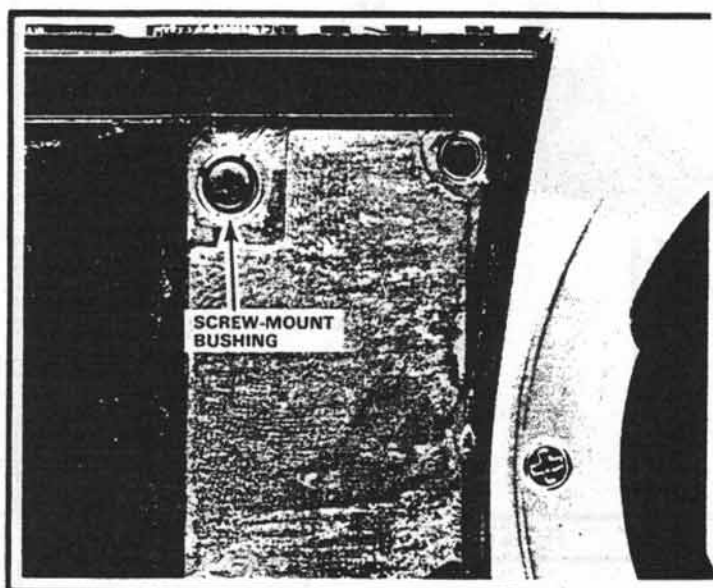

Figure 58

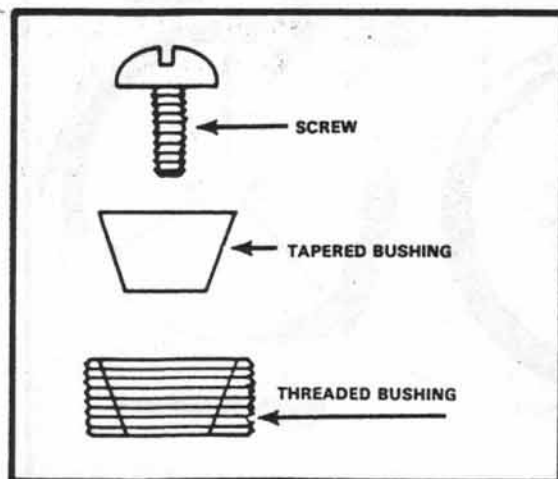

Figure 59

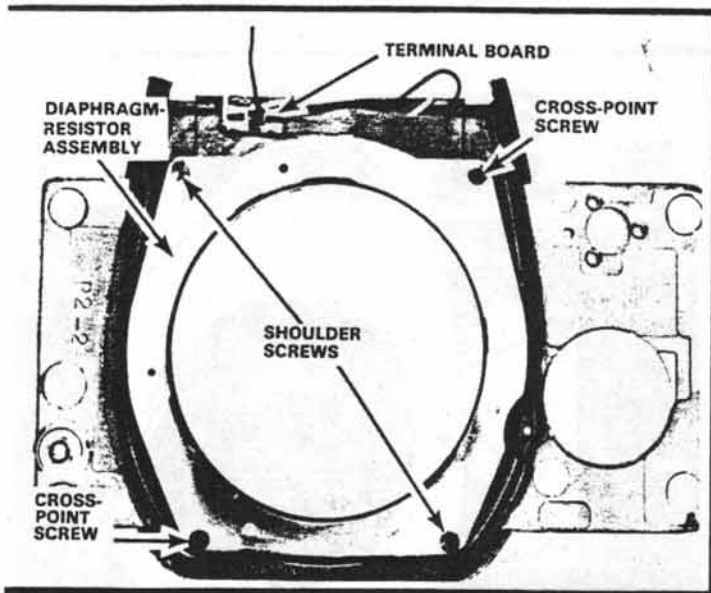

Figure 60

At the back of the front standard, Fig. 60, you can now see the terminal board for the diaphragm-resistor wires. Notice that you can unsolder either the lead wires or the diaphragm-resistor wires from the terminal board. If you're removing the front standard to reach the shutter mechanism, unsolder the lead wires, Fig. 60. But if you want to replace the diaphragm resistor, unsolder the diaphragm-resistor wires.

To remove the diaphragm-resistor assembly, take out the four screws shown in Fig. 60. Notice that the screw in the upper left-hand corner and the screw in the lower right-hand corner have slotted heads -- these are shoulder screws which position the diaphragm-resistor assembly. The other two screws have cross-point heads.

Lift aside the diaphragm-resistor assembly as shown in Fig. 61. That's as far as you'll have to disassemble the mechanism to replace the diaphragm resistor; just unsolder the wires and replace the complete diaphragm-resistor assembly. However, the problem may not require a replacement part. If you're getting erratic readings from the diaphragm resistor, the assembly may simply require cleaning.

You can then remove the diaphragm-metering ring, Fig. 61, to clean the brushes and the contact surfaces. First, disconnect the metering-ring spring, Fig. 61 -- disconnect the end of the spring that hooks to a hole in the side of the diaphragm-metering ring.

Now, rotate the diaphragm-metering ring in a clockwise direction. The diaphragm-metering ring should rotate freely until it comes against a stop. Now, the tab on the diaphragm-metering ring aligns with the screw hole in the lower right-hand corner of the diaphragm-metering plate. You can then lift out the diaphragm-metering ring, Fig. 62.

Notice that the diaphragm-metering plate has three cutouts on its inside circumference, Fig. 62. Also, the diaphragm-metering ring, Fig. 62, has three lugs. To replace the diaphragm-metering ring, you must pass its three lugs through the three cutouts (that's why you had to rotate the diaphragm-metering ring fully clockwise to separate it from the diaphragm-metering plate).

REASSEMBLY: To replace the diaphragm-metering ring, align its tab with the screw hole in the lower right-hand corner of the diaphragm-metering plate. The three lugs should then pass through the clearance cutouts. Now, rotate the diaphragm-metering ring counterclockwise as far as it will go. And reconnect the metering-ring spring to the hole in the diaphragm-metering ring.

With the diaphragm-metering ring removed, you can clean the brushes and the contact surfaces, Fig. 62. The diaphragm-metering ring has two brushes -- one rides against the contact band and one rides against the resistance band, Fig. 62. Notice in Fig. 62 that the yellow wire connects to the

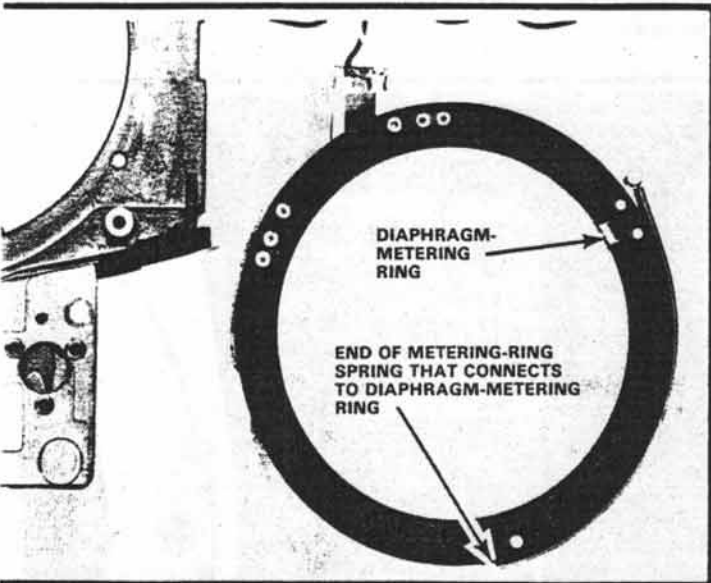

Figure 61

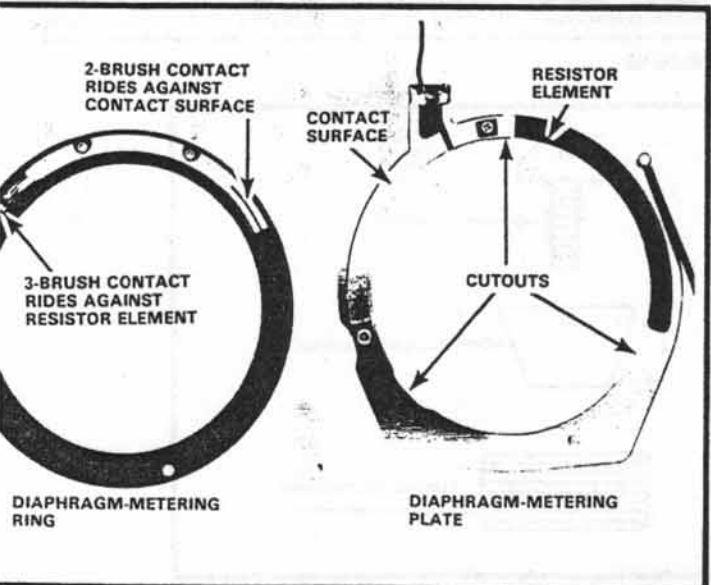

Figure 62

resistance band; the black wire connects to the contact band. So, as you turn the diaphragm-metering ring, you're changing the length of the resistance band between the black wire and the yellow wire.

Use a commercial contact cleaner or a pure solvent (such as Freon) to clean the brushes and the contact surfaces. If necessary, you can reform the brushes -- bend the brushes away from the diaphragm-metering ring to provide better contact with the diaphragm-metering plate. Then, replace the diaphragm-metering ring and again check the resistance readings.

Remember, you're looking for a smooth, even resistance change as you turn the diaphragm-metering ring. If the diaphragm resistor now checks properly, resolder the wires to the terminal board and replace the front standard.

REMOVING THE PENTAPRISM FRAME

The galvanometer mounts to the frame which holds the pentaprism and the focusing screen. You can replace the galvanometer without removing the pentaprism. However, when you're going this far in disassembly, you'll normally want to remove the pentaprism anyway. You can then clean the focusing screen.

Locate the two **pentaprism-retaining springs**, Fig. 63. The upper end of each spring hooks to a tab on the **pentaprism retainer**; the lower end of each spring hooks to a hole in the **pentaprism frame**.

To disconnect each spring, grasp the spring loop, Fig. 63, with your tweezers. Then pull down the spring, toward the pentaprism frame. Once you've disconnected the lower end of the spring, you can slip the upper end off the pentaprism-retainer tab. Repeat the procedure to remove the other pentaprism-retaining spring.

Now, lift off the pentaprism retainer and the pentaprism cover, Fig. 63. But you can't as yet lift out the pentaprism -- the two screws shown in Fig. 63 hold the pentaprism to the pentaprism frame.

The two screws allow a shifting adjustment for the pentaprism. By loosening one screw and tightening the other, you can shift the pentaprism laterally. That's another adjustment you don't want to disturb. Fortunately, there's a technique you can use to remove the pentaprism without disturbing the lateral position:

Loosen just one of the pentaprism-retaining screws. Then, lift out the pentaprism. When you replace the pentaprism, tighten only the screw which you loosened.

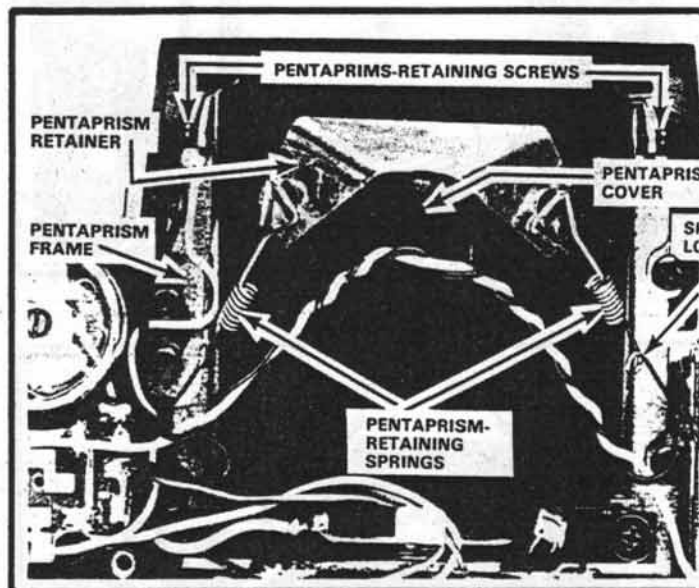

Figure 63

A strip of porous plastic around the bottom of the pentaprism seals the focusing screen from dust. But, as with any SLR, cleaning the focusing screen is a common job. You can now see the focusing screen and the galvanometer needle, Fig. 64.

Notice in Fig. 64 that two screws hold the galvanometer to the pentaprism frame. Both screws are sealed with red lacquer. When you see red lacquer used as a locking agent, you can be pretty sure that the screw holds a critical adjustment.

In the Spotmatic, the adjustment controls the zero position of the needle. With no power to the circuit, the needle should center in the focusing-screen mask, Fig. 64. What if it doesn't? You can then loosen the two screws, Fig. 64, and shift the galvanometer housing.

Removing the pentaprism also allows you to see the three photocells on the photocell circuit board, Fig. 65. Remember, the upper CdS cell, Fig. 65, is part of the photo switch. The two lower CdS cells control the needle deflection.

To remove the galvanometer, you'll have to take out the pentaprism frame, Fig. 64. Let's consider now that you know you have a defective galvanometer. You then want to replace the galvanometer with a minimum of disassembly -- and with a minimum of unsoldering. The technique we'll describe here gets you to the galvanometer with only minor disassembly; later we'll describe the technique for removing the complete exposure-meter assembly.

There are only three wires you'll have to unsolder -- the blue wire, the yellow wire, and the red wire which go to the galvanometer. All three galvanometer wires connect to the exposure-meter circuit board, Fig. 50. However, you've seen that three yellow wires actually connect to the yellow-wire land. And two red wires connect to the ground land.

So, to locate which wire goes where, it's a little easier if you first pull aside the exposure-meter circuit board (you'll

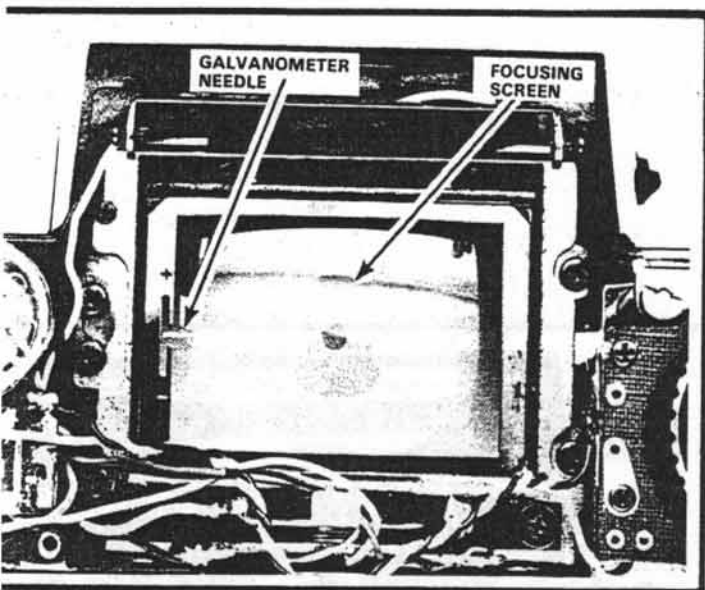

Figure 64

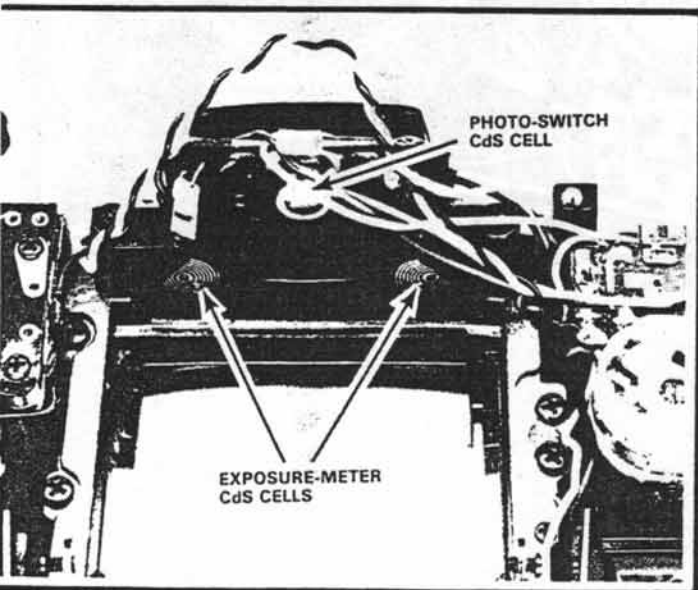

Figure 65

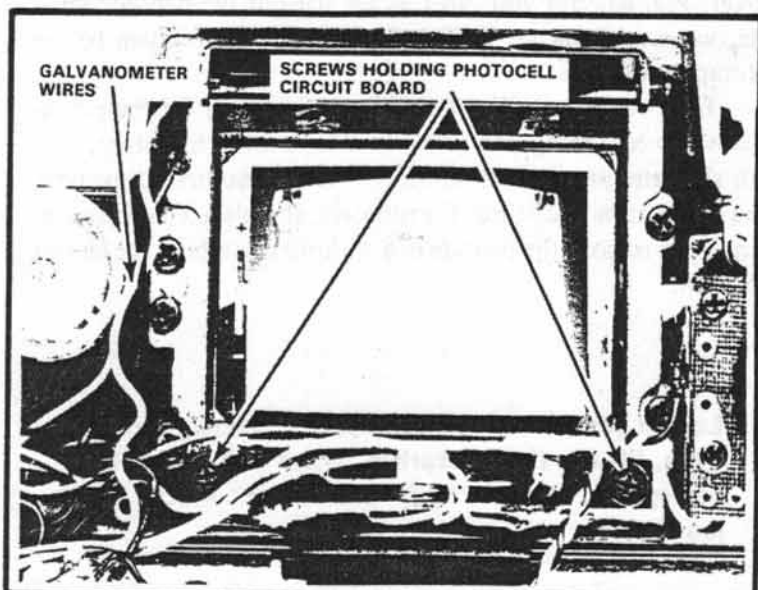

Figure 66

want the circuit board pulled aside anyway -- the exposure meter circuit board must be out of the way before you can remove the pentaprism frame). Follow the procedures described earlier to pull aside the exposure-meter circuit board (page 25).

Now, locate each of the three wires coming from the galvanometer, Fig. 66. And unsolder the three galvanometer wires from the exposure-meter circuit board.

It's not necessary to unsolder the wires coming from the photocell circuit board. Instead, just remove the two screws, Fig. 66. Then lift aside the photocell circuit board, leaving its wires connected to the exposure-meter circuit board.

Finally, remove the four screws holding the pentaprism frame, Fig. 67. One of the screws is a little difficult to reach without removing the speed resistor. Also notice that the pentaprism-frame screw in the upper left-hand corner, Fig. 67, is smaller than are the other three screws.

Lift out the pentaprism frame together with the galvanometer, Fig. 68. If your previous troubleshooting pinpointed an open coil, you can now replace the galvanometer assembly. Just remove the two sealed screws, Fig. 68, and slide out the galvanometer (away from the pentaprism frame).

When you install the new galvanometer, you must adjust the zero position of the needle. Remember, the needle should center in the focusing-screen mask. So, before tightening the two screws, shift the galvanometer housing until the needle centers. Then, hold the galvanometer in position as you tighten the two screws, Fig. 68.

SHORTCUT TO REPLACING THE GALVANOMETER

We've described the procedure for completely removing the pentaprism frame. However, when you know you must replace the galvanometer, there's a shortcut procedure you can use.

Check first to see if the focusing screen needs cleaning. If it doesn't, leave the pentaprism in place. Also, leave the photocell circuit board installed.

Unsolder four wires from the exposure-meter circuit board -- the three galvanometer wires, Fig. 46, and the black wire that goes to the negative battery terminal, Fig. 50. Lift aside the exposure-meter circuit board by taking out its two screws.

Next, remove the four screws holding the pentaprism frame, Fig. 67. You can now lift the pentaprism frame high enough to slide out the galvanometer. Remove the two galvanometer screws. Then, slide the galvanometer out of the pentaprism frame.

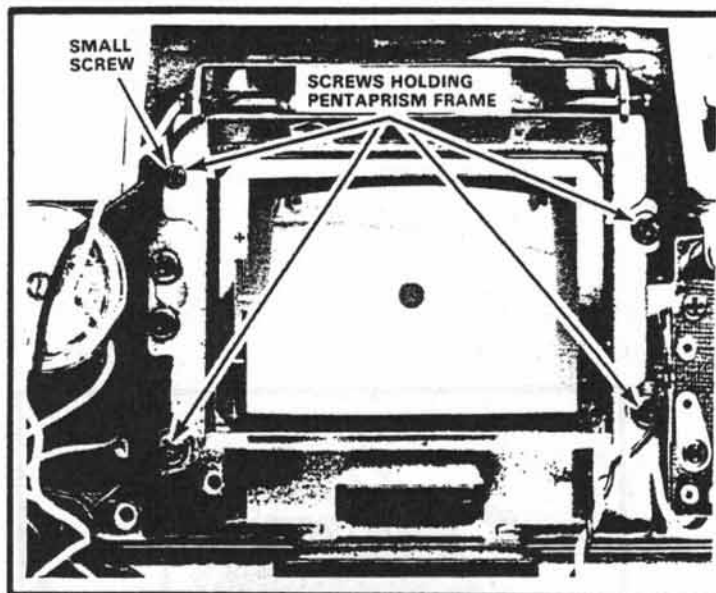

Figure 67

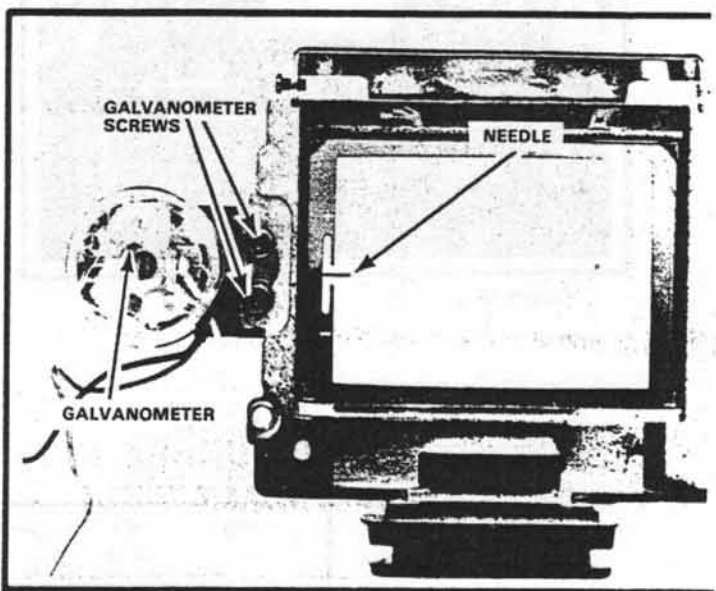

Figure 68

CALIBRATING THE EXPOSURE METER

Spotmatic models using the type of exposure meter described here (as opposed to the earlier balanced-bridge design) have two variable-resistor adjustments, Fig. 69. The two variable resistors provide adjustments for the linearity of the response.

J209, Fig. 69, connects in series with both photocells. So it's a high-light adjustment. The other variable resistor, J210, connects in series with just one of the photocells. J210 then provides a low-light adjustment. You can see the connections of the variable resistors in Fig. 42.

However, *Pentax regards the variable resistors as factory adjustments*. Unless the meter has a linearity problem, you should not have to disturb the variable resistors. But you can make a total-response adjustment by adding a **calibration resistor** to the exposure-meter circuit board.

Fig. 70 illustrates the concept. J504 is the calibration resistor. Notice that one end of J504 connects to the collector of the photo-switch transistor. We've temporarily left the other end disconnected.

Consider, then, that the needle isn't moving up far enough when you test the exposure meter. Since you're getting an underexposure indication, you know that you need more current through the galvanometer coil. Just connect point "A" to point "B" in Fig. 70. That lowers the resistance in the upper path.

What if you connect point "A" to point "C"? More current then flows through the lower galvanometer coil. The needle moves down further for the same light conditions.

You can control the actual amount of additional needle movement by changing the value of J504, Fig. 70. Suppose

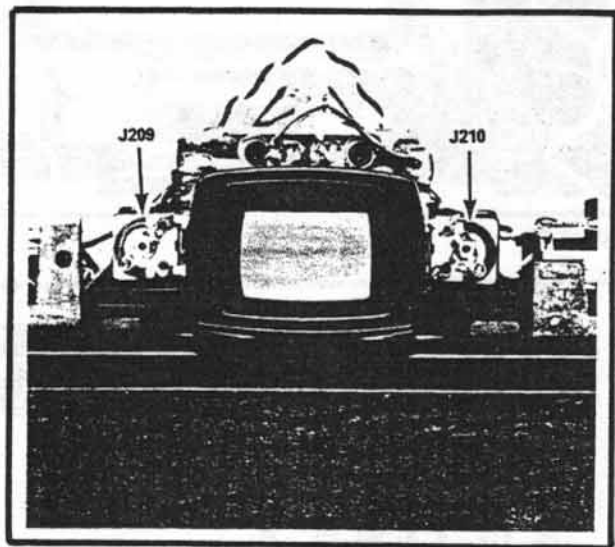

Figure 69

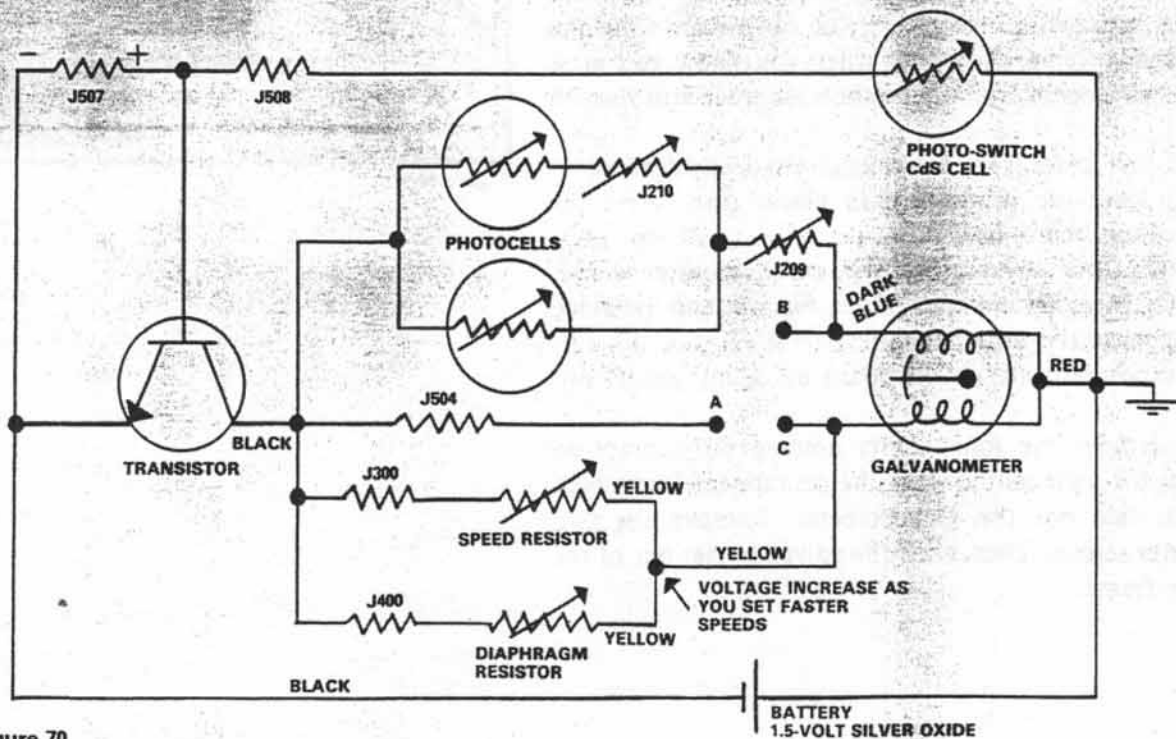
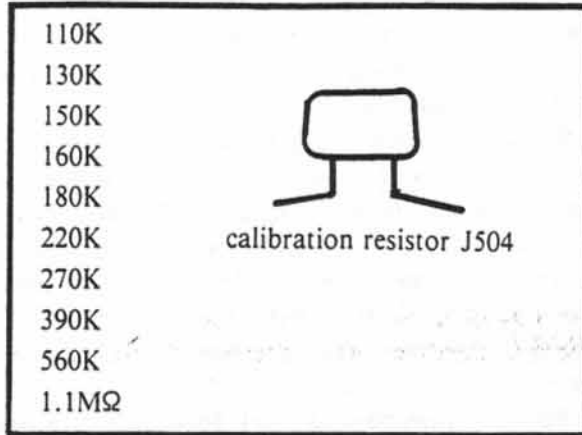

Figure 70

that you want the needle to move up. Yet, when you connect point "A" to point "B," the needle moves up too far. That means you must replace J504 with a resistor having a larger ohmic value.

Pentax supplies the calibration resistors in ten different values:



Notice that the resistors are available in 1/10-step increments. So, by changing from one resistor value to the next resistor value, you can correct the response by 1/10 EV. Going from the 110K resistor to the 1.1MΩ resistor changes the response by one full stop.

Let's now apply the principle to the actual K1000 circuit. Unless the camera has been worked on before, you probably won't have a calibration resistor on the exposure-meter circuit board. There's probably just one fixed resistor -- the transistor-bias transistor J507.

The pictorials, Fig. 71, show how to connect the calibration resistor. If you need more current through the upper coil, solder the calibration resistor to the circuit-board lands as shown in Fig. 71 A. Notice that one lead of the resistor connects to the transistor's collector; the other lead connects to the blue wire of the galvanometer.

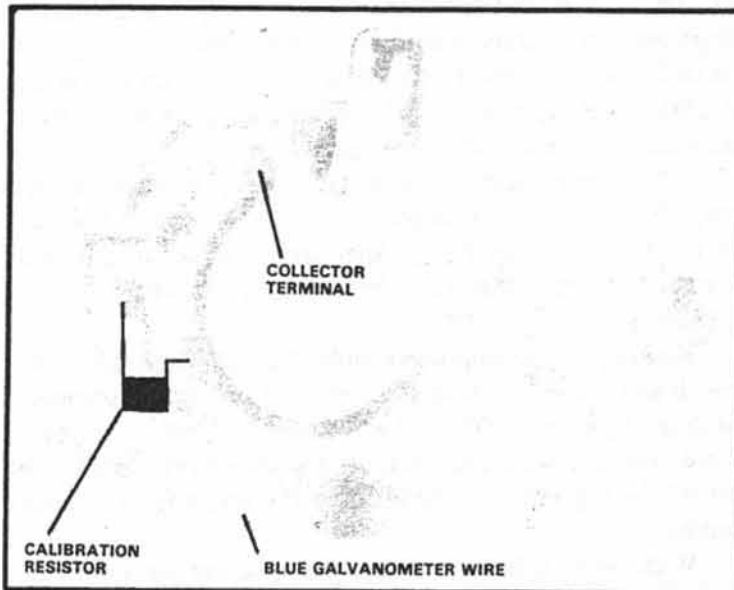

Figure 71A

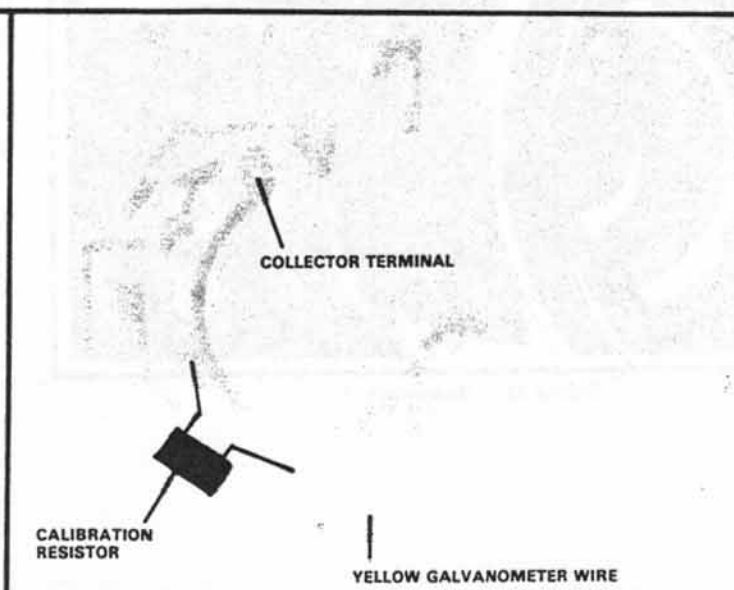

Figure 71B

If you need more current through the lower coil, solder the calibration resistor as shown in Fig. 71 B. One resistor lead still connects to the transistor's collector. But the other lead connects to the yellow wire of the galvanometer.

Changing fixed resistors isn't the most convenient of adjustments. Fortunately, you normally don't have to calibrate the K1000 meter. If the meter reads within 1/2 stop, it's within tolerance. And, in most instances, the meter will be well within the 1/2-stop tolerance range.

But what if someone else has worked on the camera before you got it? If another technician has disturbed the variable resistors, Fig. 69, you may encounter a linearity problem -- the meter may read an overexposure under bright-light conditions and an underexposure under dim-light conditions (or vice versa). Changing the calibration resistor J504 won't correct the problem. Remember, J504 provides a total-response adjustment.

You may then have to work back and forth between the two variable resistors to correct the linearity. Again, adjust J209 for a high-light level; adjust J210 for a low light level. Alternately, you can replace the complete photocell circuit board. A replacement photocell circuit board comes with the variable resistors already adjusted.

VARIATIONS ON THE K1000 METER

We mentioned that several other Spotmatic models have nearly the same exposure-meter design. The early screw-mount Spotmatics combine balanced-bridge circuits with stopped-down metering. But later screw-mount models feature full-aperture metering using circuits similar to the one you've studied.

The screw-mount lenses for full-aperture metering work the same way as do the bayonet-mount lenses -- a tab on the diaphragm-setting ring rotates the camera's metering ring. But the earlier screw-mount Pentax lenses don't have the tab on the diaphragm-setting ring. That's because the first lenses were designed for stopped-down metering.

When Spotmatics switched to full-aperture metering, however, they didn't make the older lenses obsolete. You can use the older lenses on the full-aperture-metering cameras. But you must take your exposure reading through a stopped-down aperture.

Pushing up the **stop-down slide**, Fig. 72, stops down the lens. It simultaneously throws an internal switch to disconnect the diaphragm resistor from the circuit. Fig. 73 shows the portion of the schematic that includes the **stop-down switch**; the rest of the schematic is identical to the one you've already studied.

With the stop-down switch in the solid-line position, Fig. 73, the diaphragm resistor connects to the galvanometer --that's the full-aperture position. Pushing up the stop-down

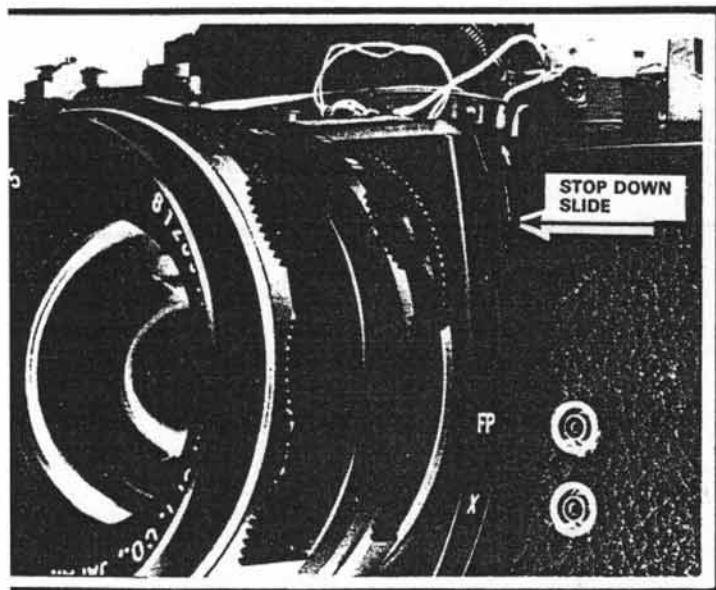

Figure 72 Spotmatic F

slide, Fig. 72, then moves the stop-down switch to the dashed-line position, Fig. 73.

In the dashed-line position, the stop-down switch disconnects the diaphragm resistor from the galvanometer. So the diaphragm resistor has no effect on the reading. How, then, does the meter know your diaphragm setting? Since you're taking your reading through the taking aperture, the f/stop setting affects the resistance of the CdS photocells.

Notice in Fig. 73 that you have one additional adjustment. In the dashed-line position, the stop-down switch connects a variable resistor between the photo-switch transistor and the galvanometer. The variable resistor allows you to adjust the meter's accuracy in the stopped-down mode.

Fig. 74 shows the variable resistor in the popular Spotmatic F. The exposure-meter circuit board should look

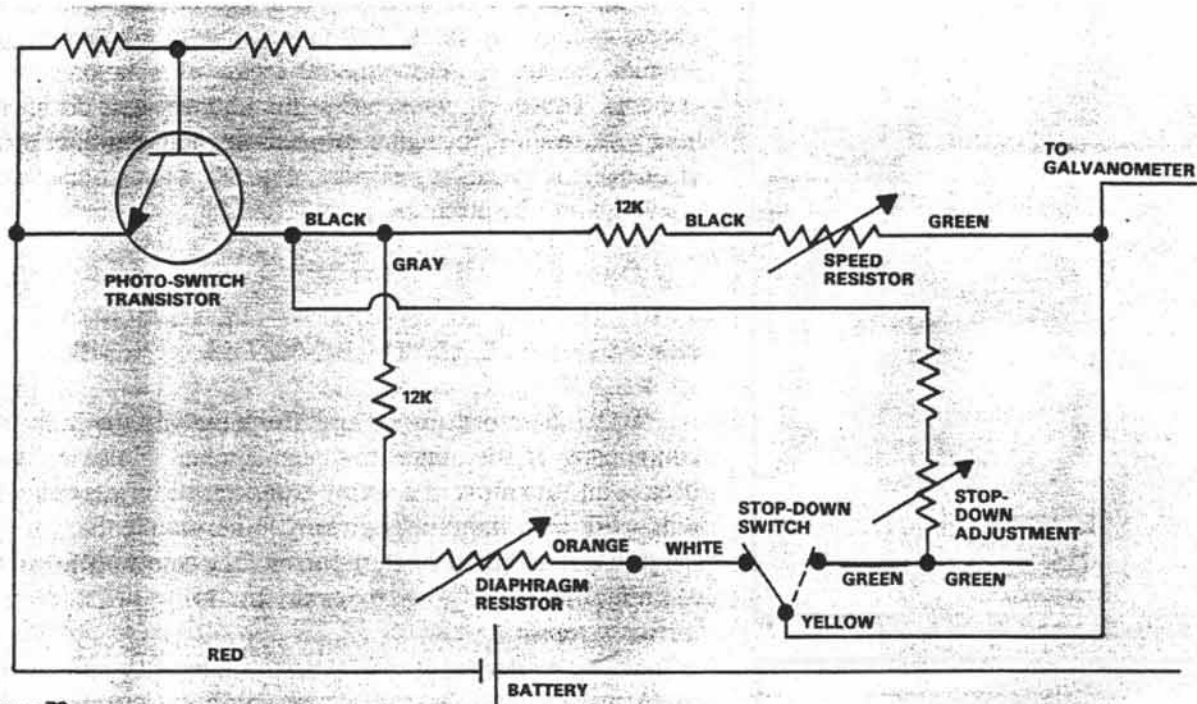

Figure 73

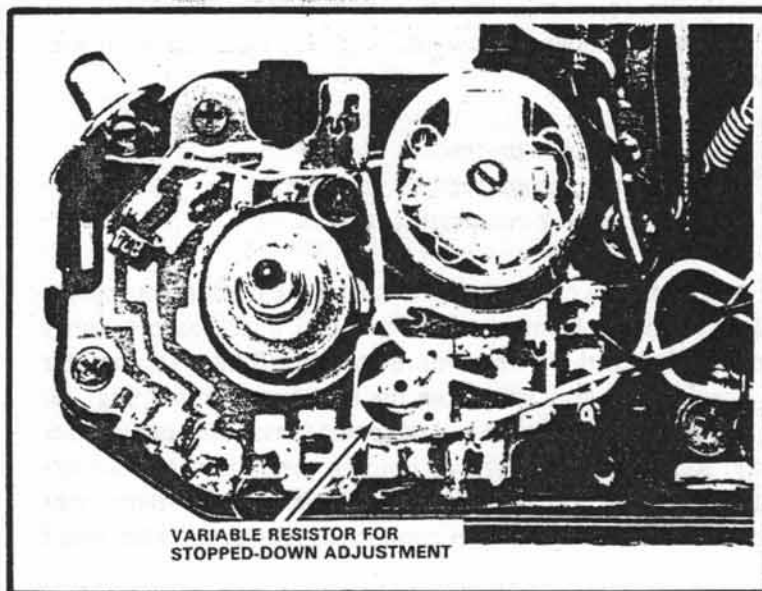

Figure 74
Exposure-meter circuit board in Spotmatic F. The galvanometer and the diaphragm resistor in the Spotmatic F won't interchange with those in the K1000. But the other parts of the exposure meter are interchangeable.

familiar -- except for the variable resistor, it's the same as the board in the K1000. In fact, you can use a Spotmatic F board to replace a K1000 board; just remove the variable resistor, Fig. 74.

To adjust the Spotmatic F meter, follow the same procedures as we've already described. Here, you're adjusting the accuracy in the full-aperture mode. Then, push up the stop-down switch. And use the variable resistor shown in Fig. 74 to adjust the accuracy in the stopped-down mode.

The Spotmatic F also illustrates one of the reasons you should avoid disturbing the variable resistors on the photocell circuit board, Fig. 69. By working back and forth between the two linearity adjustments, you'll be able to correct the reading in the full-aperture mode. But you may then find that the meter reads inaccurately in the stopped-down mode.

You can have the same problem with the K1000. There's a special adapter for the K1000 -- the K-mount adapter -- which permits the use of screw-mount lenses with bayonet-mount cameras. However, when using the adapter, you do have to take your reading through a stopped-down aperture. If you've disturbed the linearity resistors, Fig. 69, your stopped-down reading won't be accurate.

REMOVING THE EXPOSURE-METER ASSEMBLY AS A UNIT

We've described procedures for removing the individual components of the exposure-meter system. However, you'll often want to remove the entire exposure-meter assembly as a unit -- just to get it out of your way. For example, there may be no problem with the exposure meter. But you want to get the assembly out of the way to repair the transport, shutter, or mirror systems.

Again, *it's not necessary to remove the pentaprism*. But, if the focusing screen needs cleaning, you'll have to remove the pentaprism anyway. Remember to loosen just one of the pentaprism-adjustment screws.

Now, unsolder three wires, Fig. 75, from the exposure-meter circuit board:

1. the diaphragm-resistor black wire
2. the diaphragm-resistor yellow wire
3. the battery-compartment black wire.

If you wish, you can wait and unsolder the diaphragm-resistor wires from the front-standard terminal board as previously described. But there's one more wire you'll have to unsolder -- unsolder the gray wire from the hot-shoe terminal, Fig. 76.

You can now get the exposure-meter assembly out of your way. Remove the two screws holding the exposure-meter circuit board, Fig. 48. Then, lift aside the exposure-meter circuit board while leaving its wires connected. Also remove the speed

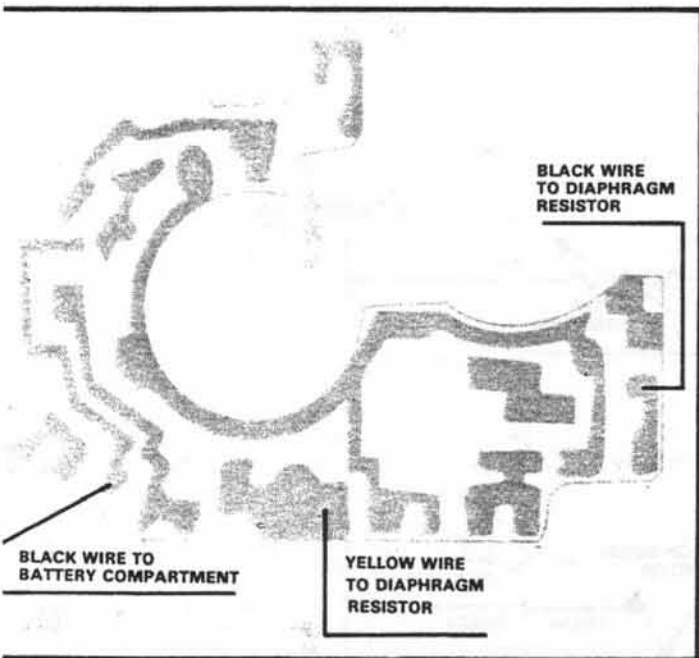

Figure 75 Exposure-meter circuit board

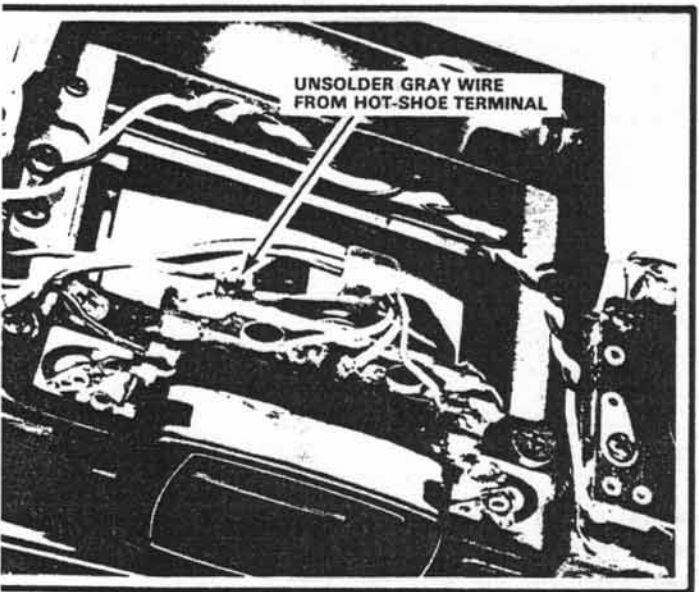

Figure 76

resistor. Just leave the speed-resistor wires connected to the exposure-meter circuit board.

Next, take out the four screws holding the pentaprism frame, Fig. 77. Lift out the complete exposure-meter assembly -- the assembly which includes the pentaprism frame, the exposure-meter circuit board, and the speed resistor.

REASSEMBLY: Before replacing the exposure-meter assembly, check the positions of the two wires which pass through the camera-body hole, Fig. 78. The black wire is the one you unsoldered from the exposure-meter circuit board; the gray wire is the one you unsoldered from the hot-shoe terminal. Make sure that both wires sit within the recessed area of the body casting, Fig. 78. If the wires sit above the raised section of the body casting, they'll be crushed by the galvanometer as you replace the exposure-meter assembly.

Also notice the three adjustment setscrews in Fig. 78. The spring-loaded focusing screen sits on top of these setscrews. You can see the focusing-screen tray at the bottom of the pentaprism frame, Fig. 79 (in Fig. 79 we've removed the exposure-meter assembly with the pentaprism still in place). Try pushing up the focusing-screen tray, Fig. 79 -- you'll then feel the spring tension.

When you replace the pentaprism frame, the focusing-screen tray sits on top of the setscrews. The setscrews then push up the focusing-screen tray (toward the pentaprism). So the setscrews determine the distance between the focusing screen and the mirror.

The three setscrews, Fig. 78, provide your adjustment for the focusing-screen height. For example, say that the focus at the film plane is correct. But the image formed on the focusing screen is out of focus at infinity. You can then change the height of the focusing screen to adjust the focus of the viewed image.

At first glance, it appears that the focusing-screen adjustment setscrews would be difficult to reach. However, you don't have to remove the pentaprism frame to reach the setscrews. In fact, you don't even have to disassemble the camera -- just remove the lens.

You can then reach the other ends of the focusing-screen adjustment setscrews. Pentax conveniently provides screwdriver slots at both ends of each screw. So, by using a screwdriver with a long blade, you can work through the lens opening to adjust the focusing-screen height. Turning the three setscrews allows you to correct the focus at the corners -- as well as at the center -- of the focusing screen.

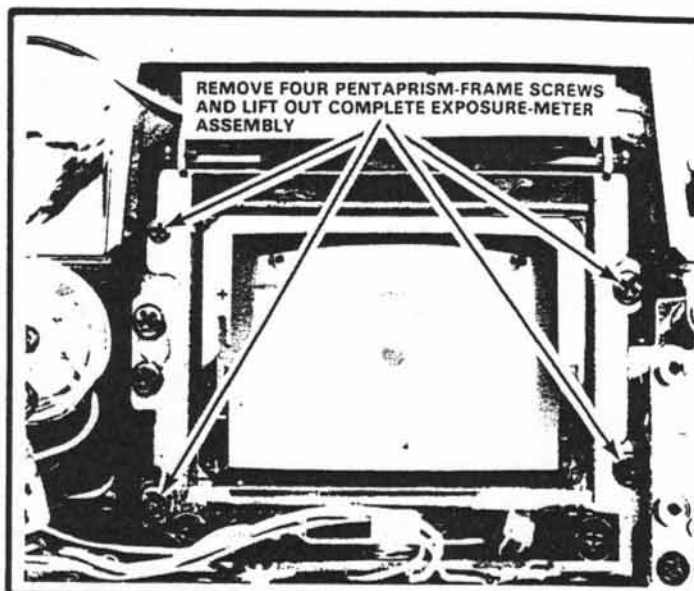

Figure 77

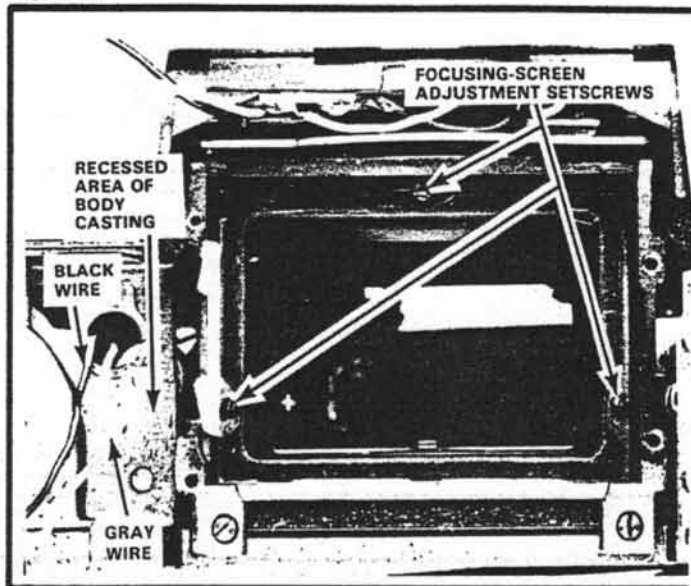

Figure 78

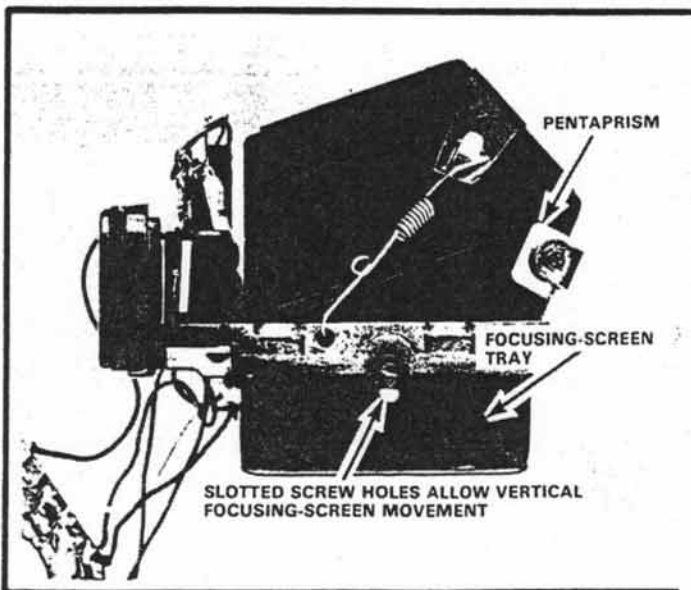

Figure 79 Assembly with pentaprism in place.

Pentax K1000

contents

43	DISASSEMBLY TO REACH THE MIRROR CAGE AND SYNC CONTACTS
43	OPERATION OF THE SYNC CONTACTS
46	CHECKING THE SYNC CONTACTS
46	MIRROR-CAGE COUPLING TO THE OPENING CURTAIN
46	REMOVING THE MIRROR CAGE
49	OPERATION OF THE MIRROR CAGE
51	REMOVING THE MIRROR-COCKING LEVER
51	TRANSPORT-RELEASE SYSTEM

Section 2



DISASSEMBLY TO REACH THE MIRROR CAGE AND SYNC CONTACTS

What are the common mirror-cage problems in the SLR? Here are the ones you'll encounter most frequently:

1. The mirror rises, but fails to release the opening curtain.
2. The mirror fails to return to the viewing position after the exposure.
3. The mirror fails to rise when you push down the release button.
4. The mirror releases as soon as you complete the cocking stroke — it doesn't wait for you to push the release button.

For any of these malfunctions, you can suspect a problem with the mirror mechanism (or with the parts which couple to the mirror mechanism). You then want to reach the mirror cage with a minimum amount of disassembly.

Simply removing the front standard uncovers most of the mirror-cage controls, Fig. 80. Notice in Fig. 80 that we've left the exposure-meter assembly in place. However, assuming you're going further in the disassembly, you might remove the exposure-meter assembly as described in the last topic.

Also notice in Fig. 80 that you can now reach the sync contacts. So, if the camera isn't firing the flash, you need only remove the front standard. Before covering the operation and removal of the mirror-cage, then, let's go through the operation of the sync contacts.

OPERATION OF THE SYNC CONTACTS

As you'll recall, the X-sync contacts close when the opening curtain uncovers the focal-plane aperture. That means the part which closes the X-sync contacts must turn with the opening curtain.

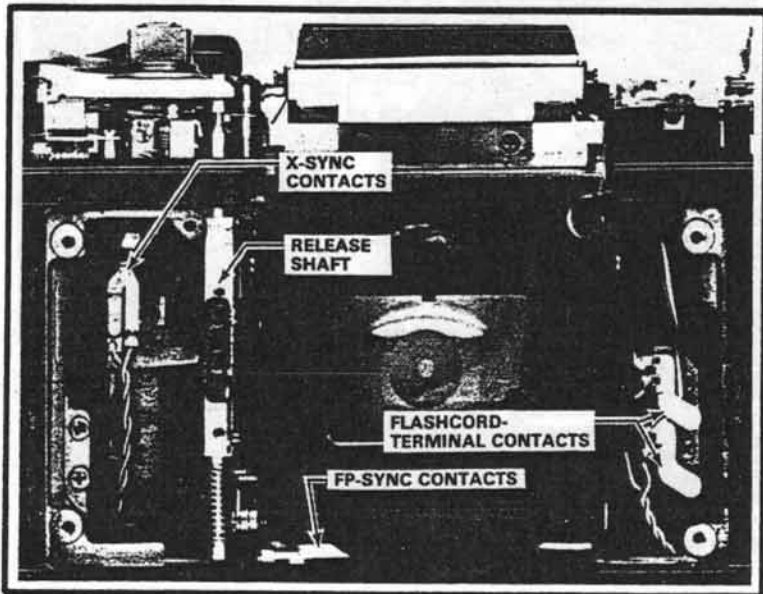

Figure 80

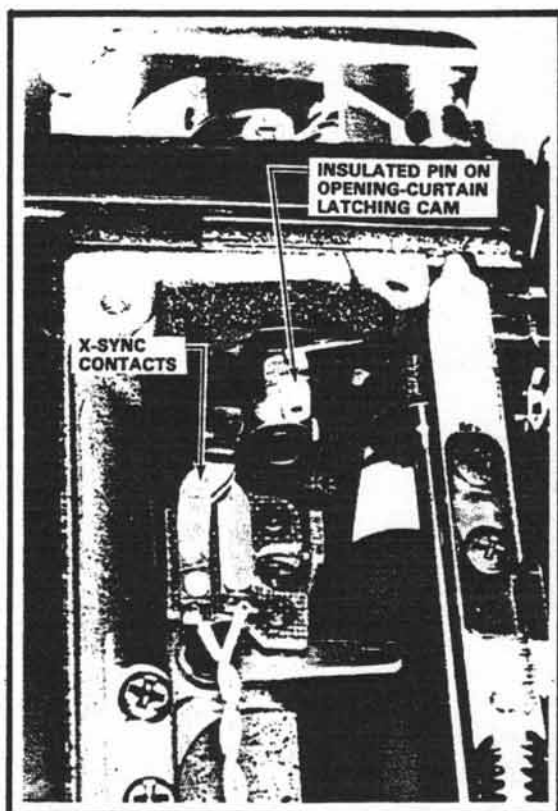

Figure 81 Shutter Cocked

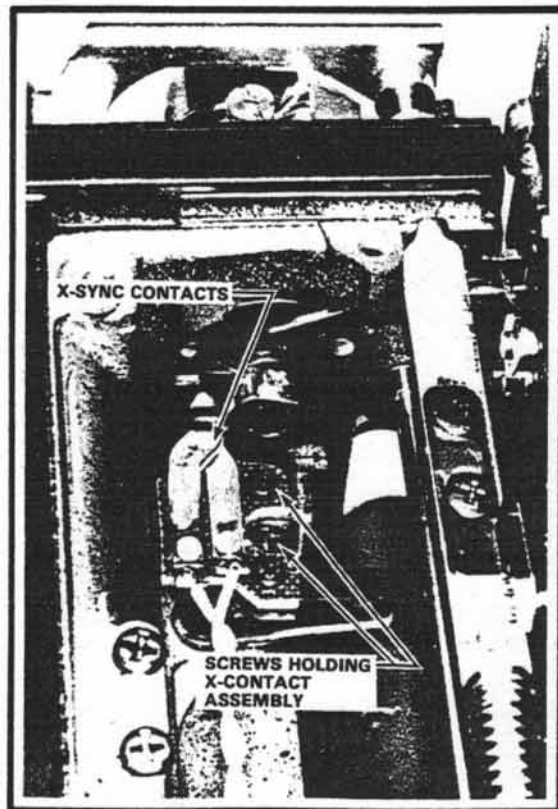

Figure 82 Shutter Released

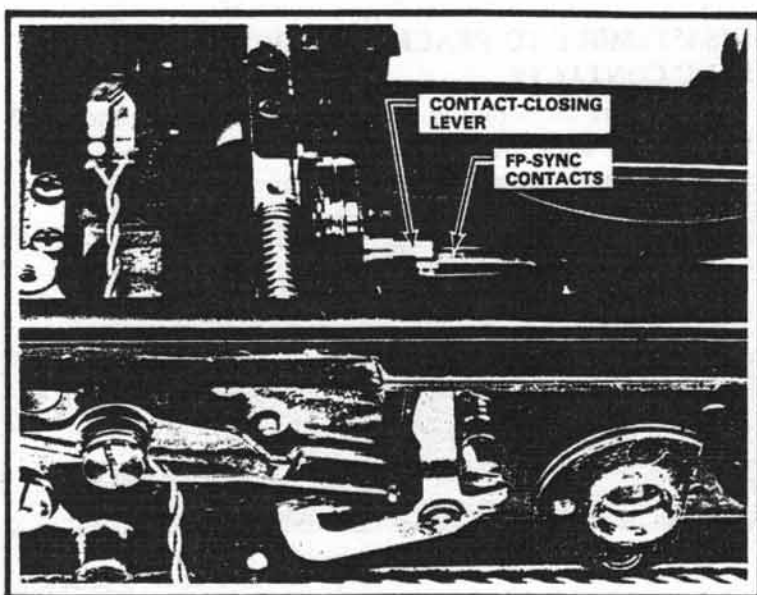

Figure 83

Notice that the pin on the contact-closing lever is not insulated. When the contact-closing lever closes the FP-sync contacts, it completes the circuit through ground.

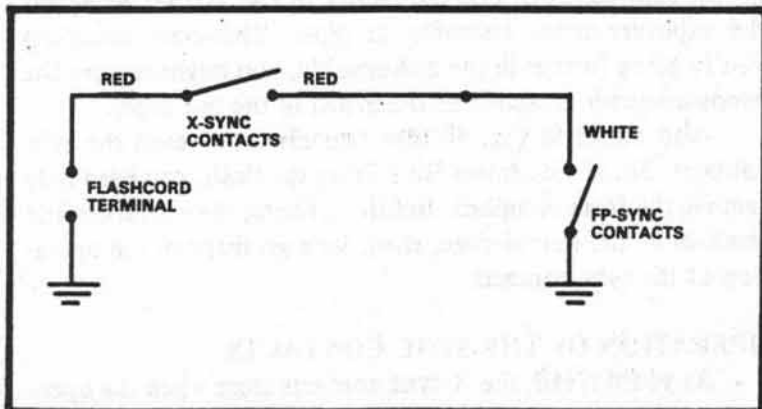

Figure 84

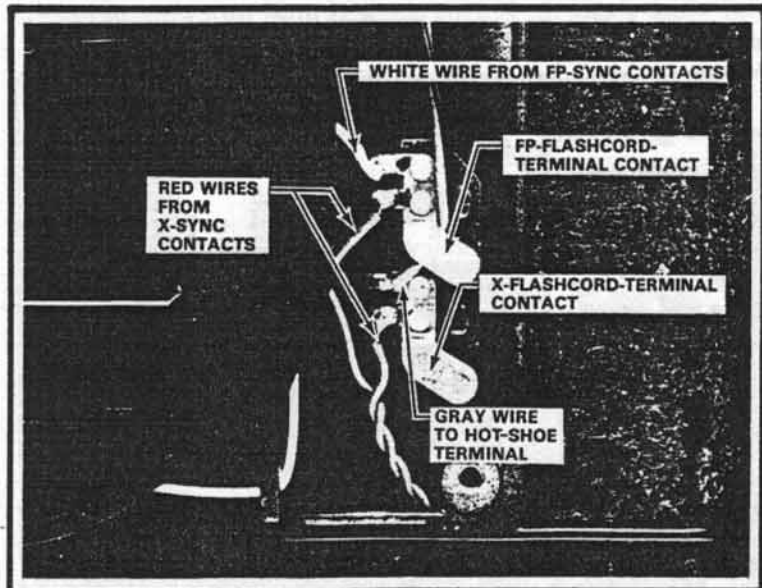

Figure 85

Try watching the X-sync contacts as you cock and release the shutter. You can then locate the part which closes the X-sync contacts. Notice the insulated pin on the **opening-curtain latching cam**, Fig. 81.

The opening-curtain latching cam attaches to the opening-curtain wind gear (the gear that winds the opening curtain). With the shutter cocked, the insulated pin moves away from the X-sync contacts, Fig. 81. The X-sync contacts now open.

But the opening-curtain latching cam rotates as the opening curtain crosses the focal-plane aperture. The insulated pin then strikes the back side of the X-sync contacts, Fig. 82. As a result, the opening-curtain latching cam closes the X-sync contacts to fire the flash.

With the shutter released, Fig. 82, the X-sync contacts remain closed. Wouldn't the flash then fire if you connected it to the flashcord terminal? Initially, that seems to be the case. However, there's another pair of contacts -- the FP-sync contacts -- serving as a safety switch, Fig. 83.

Notice that the FP-sync contacts are normally open, Fig. 83. The FP-sync contacts close as the mirror moves to the taking position (about the same time as the shutter releases). So the FP-sync contacts close *before* the X-sync contacts close.

In Fig. 84, you can see why the FP-sync contacts must be closed before the X-sync contacts can fire the flash. With the FP-sync contacts open, the flashcord terminal doesn't have a complete path to ground.

Here, then, is the sequence:

- With the shutter released, the X-sync contacts are closed. But the FP-sync contacts remain open, breaking the circuit to ground.
- As you cock the shutter, the X-sync contacts open.
- When the mirror moves to the taking position, the FP-sync contacts close. But the X-sync contacts are now open. So you still don't have a complete circuit to ground.
- The opening curtain then crosses the aperture and closes the X-sync contacts. Since the mirror is still in the taking position, the FP-sync contacts remain closed. Now, both contacts are closed. And the flashcord terminal has a complete circuit path to ground.

You can see the flashcord-terminal contacts at the other side of the camera, Fig. 85. The flashcord terminal in the front standard comes against the lower flashcord-terminal contact. Notice that the front standard has a hole for the FP-flashcord terminal, Fig. 86. In other Spotmatic models, the FP-flashcord terminal comes against the upper flashcord-terminal contact. But the K1000 eliminates the FP-sync feature by leaving out the second flashcord terminal.

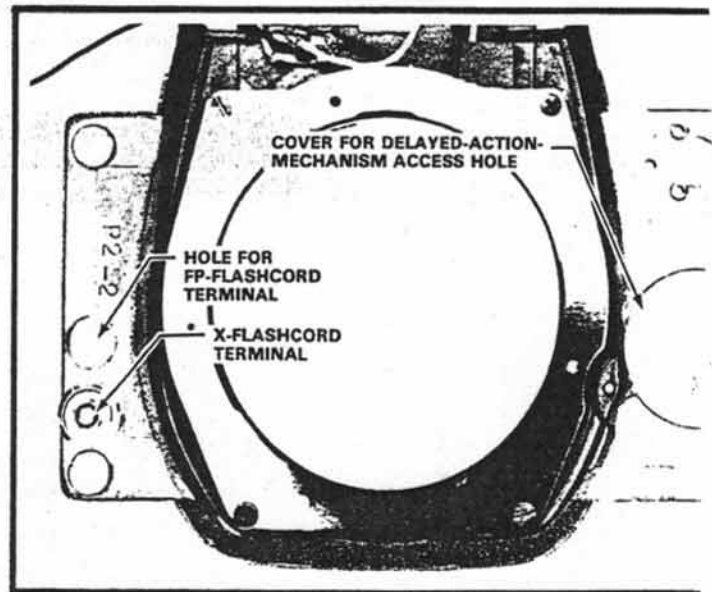

Figure 86 Back of front standard

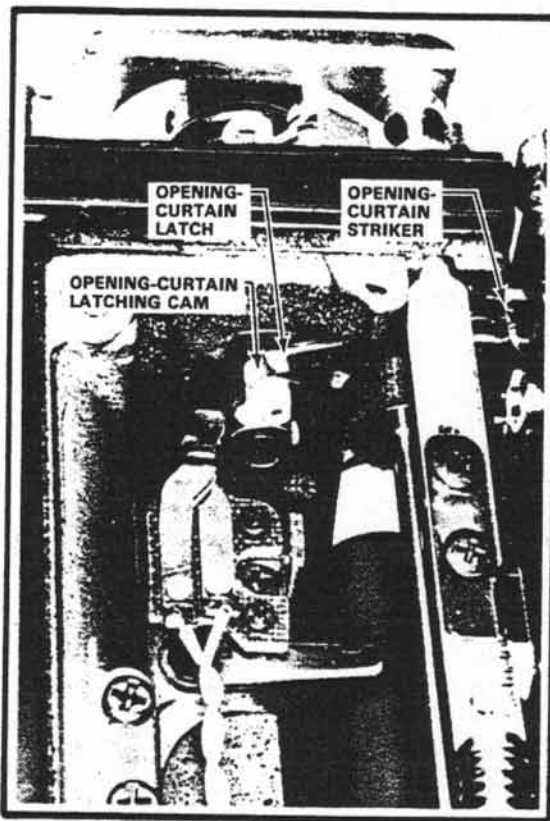

Figure 87 Shutter cocked

CHECKING THE SYNC CONTACTS

As you've seen, the FP-sync contacts serve as a safety switch for the X-sync contacts. So, if the flash isn't firing, either set of contacts could be at fault.

You can use your ohmmeter to check the sync contacts. Check the FP-sync contacts first (remember, the FP-sync contacts must be closed before the X-sync contacts can fire the flash). Connect your ohmmeter leads between the FP-flashcord contact, Fig. 85, and ground (any metal portion of the camera). You should read an open circuit.

Then, release the shutter at the bulb setting. While you're holding open the shutter on bulb, your ohmmeter should indicate continuity.

Use the same technique to check the X-sync contacts. But this time connect your ohmmeter between the X-flashcord contact, Fig. 85, and ground. Again, you should read an open until you release the shutter. While holding open the shutter on bulb, you should read continuity.

If you have to replace the X-sync contacts, unsolder the red wires from the flashcord-terminal contacts, Fig. 85 -- not from the X-sync contacts. Replacement X-sync contacts come with the red wires already connected. Just remove the two screws shown in Fig. 82 and replace the complete X-contact assembly.

MIRROR-CAGE COUPLING TO THE OPENING CURTAIN

You've already seen one purpose of the opening-curtain latching cam -- the cam closes the X-sync contacts. But the opening-curtain latching cam also provides the latching surface for the opening curtain.

Watch the opening-curtain latching cam as you slowly cock the shutter. At the end of the cocking stroke, you can see the **opening-curtain latch** drop into engagement with the opening-curtain latching cam, Fig. 87.

It's now up to the mirror to disengage the opening-curtain latch from the opening-curtain latching cam. Remember, in a single-lens reflex the mirror releases the opening curtain. As the mirror reaches the taking position, the **opening-curtain striker**, Fig. 87, comes against the opening-curtain latch.

The opening-curtain striker then drives the opening-curtain latch out of engagement with the opening-curtain latching cam. Now, the opening curtain can move across the focal-plane aperture.

REMOVING THE MIRROR CAGE

Before taking out the mirror cage, make sure you thoroughly understand the operation. Cock and release the camera several times while observing the mirror-cage coupling. Once you remove the mirror cage, you'll have to simulate these actions. You'll then be able to test the mirror cage before reassembly.

Remember, as you cock the shutter, the mirror-cocking lever pushes forward the mirror-tensioning lever, Fig. 88; that tensions the mirror-lifting spring at the bottom of the mirror cage. The mirror-catch lever, Fig. 88, holds the mirror-tensioning lever against the tension of the mirror-lifting spring.

Pushing the release shaft releases the mirror. Locate the extension arm on the release shaft, Fig. 89. As the release shaft moves down, its extension arm comes against the mirror latch, Fig. 89.

Now, the extension arm pushes the mirror latch out of engagement with the mirror-lifting lever. And the mirror-lifting lever, driven by the mirror-lifting spring, raises the mirror to the taking position.

The mirror remains in the taking position as long as the mirror-catch lever holds the mirror-tensioning lever, Fig. 88. With any focal-plane SLR, the closing curtain tells the mirror when to return. That way, the mirror can't move into the focal-plane aperture until the closing curtain has completed the exposure.

As the closing curtain crosses the aperture, the mirror-return gear rotates, Fig. 88. Then, after the closing curtain ends the exposure, the pin on the mirror-return gear strikes the mirror-catch lever. So the mirror-return gear drives the mirror-catch lever out of engagement with the mirror-tensioning lever.

Now, the tensioning-lever spring, Fig. 88, drives the mirror-tensioning lever to its starting position, Fig. 90. Notice that the end of the tensioning-lever spring passes through a hole in the mirror-tensioning lever. The other end of the tensioning-lever spring hooks to the side of the mirror-cocking lever.

To remove the mirror cage, you must first take out the tensioning-lever spring. First, disconnect the hooked end of the tensioning-lever spring from the side of the mirror-cocking lever, Fig. 90. Then remove the shoulder screw, Fig. 90. Lift out the tensioning-lever spring and the keyed washer, Fig. 91.

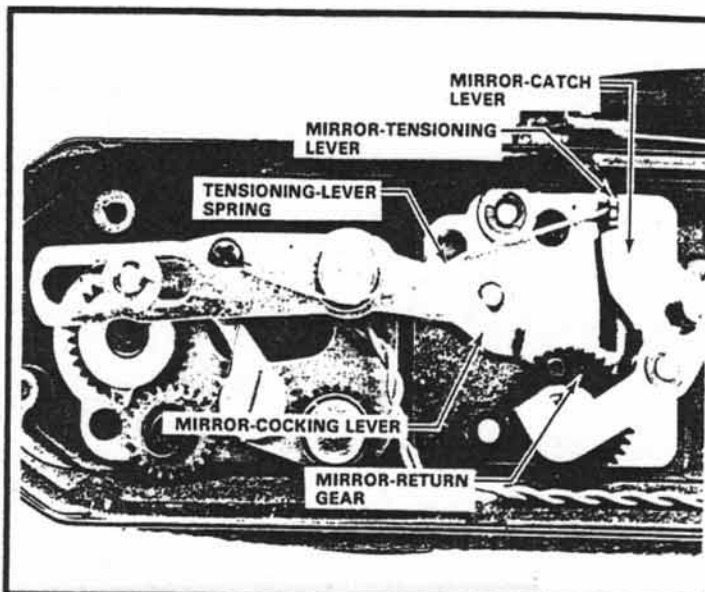

Figure 88 Shutter cocked

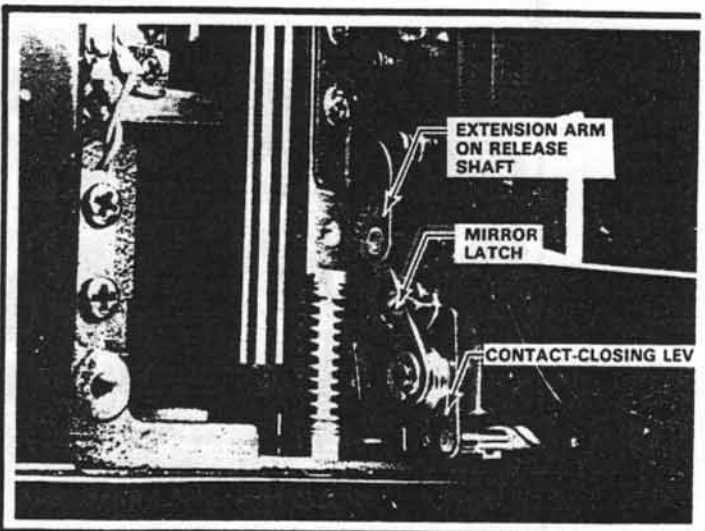

Figure 89

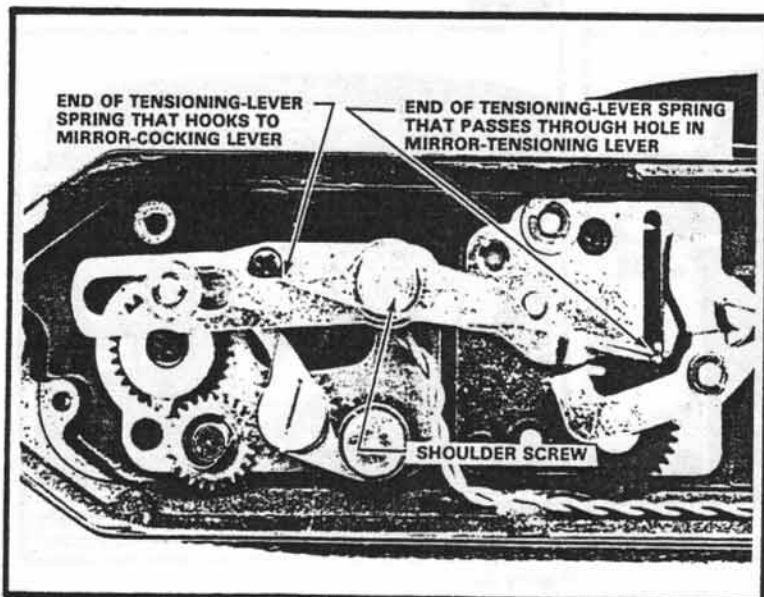

Figure 90

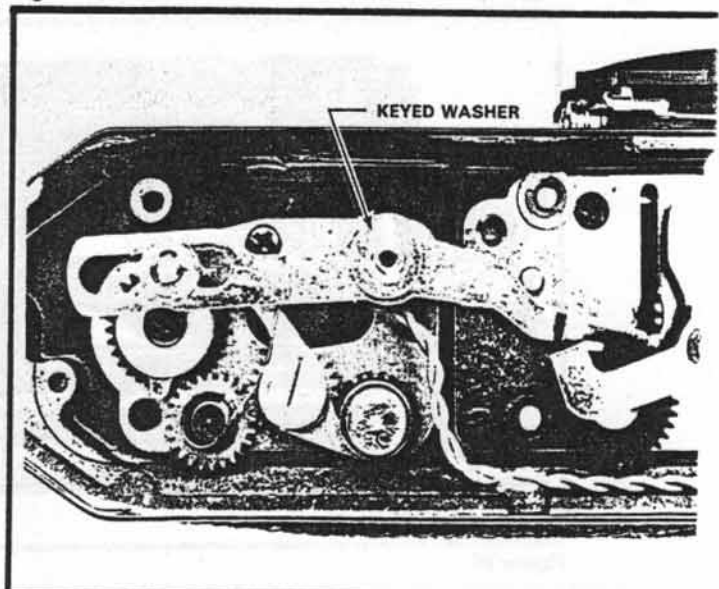

Figure 91

The keyed washer "keys" to the flat surface on the mirror-cocking-lever post, Fig. 92.

Next, unsolder the white wire from the upper flashcord-terminal contact, Fig. 93. You don't have to remove the two screws at the top of the mirror cage -- these are **positioning screws**, Fig. 94. Just remove the two screws holding the bottom of the mirror cage, Fig. 95. The screw closer to the rewind end of the camera is a shouldered screw; the other screw is a cross-point screw.

Lift the mirror cage until its upper holes clear the two positioning screws, Fig. 94. Then, tilt the mirror cage slightly forward as you lift it out of the camera.

REASSEMBLY: When you replace the mirror cage, make sure that the mirror latch is to the back of the release-shaft extension arm, Fig. 96. Test the operation after you replace the tensioning-lever spring, Fig. 90.

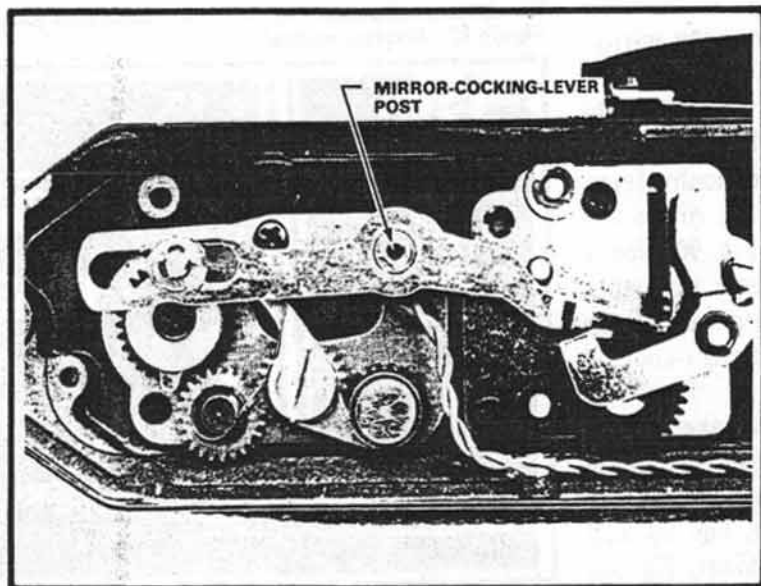

Figure 92

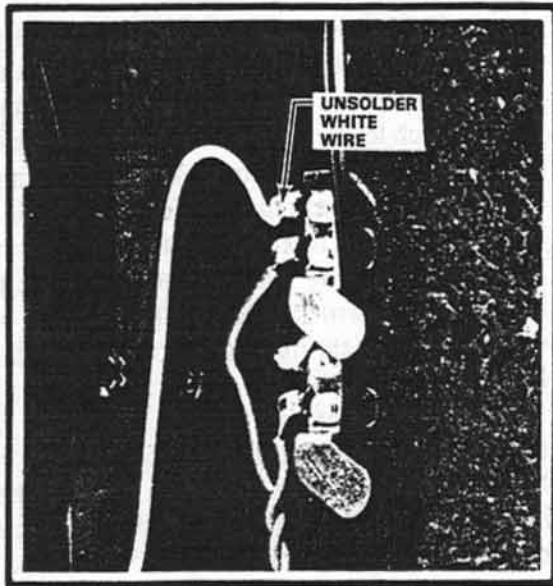

Figure 93

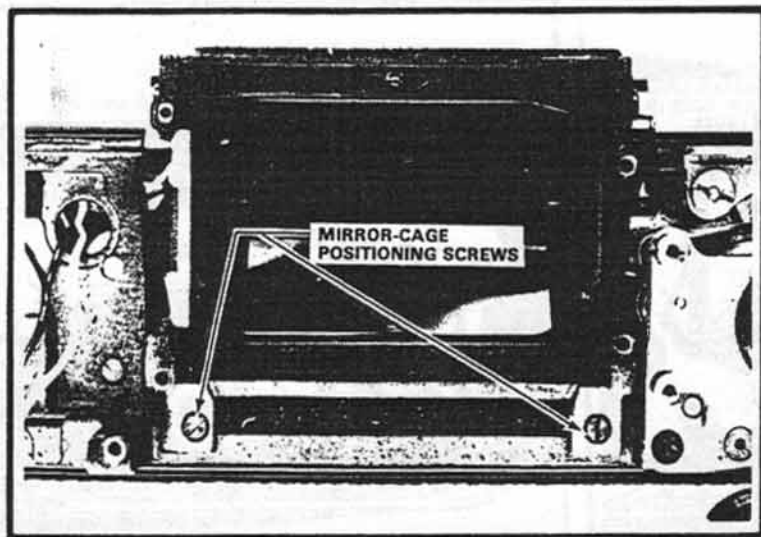

Figure 94



Figure 95

Once you've checked the operation, test the overtravel of the release shaft. Slowly depress the release shaft until the shutter releases. The mirror should release before the release shaft reaches the bottom of its travel.

You should then be able to push down the release shaft a slight distance further. That's the overtravel. If you don't have this overtravel, you can use the sliding adjustment on the release-shaft extension arm. Just loosen the two screws, Fig. 96. Then, slide down the extension arm to make the mirror release sooner; slide up the extension arm to make the mirror release later.

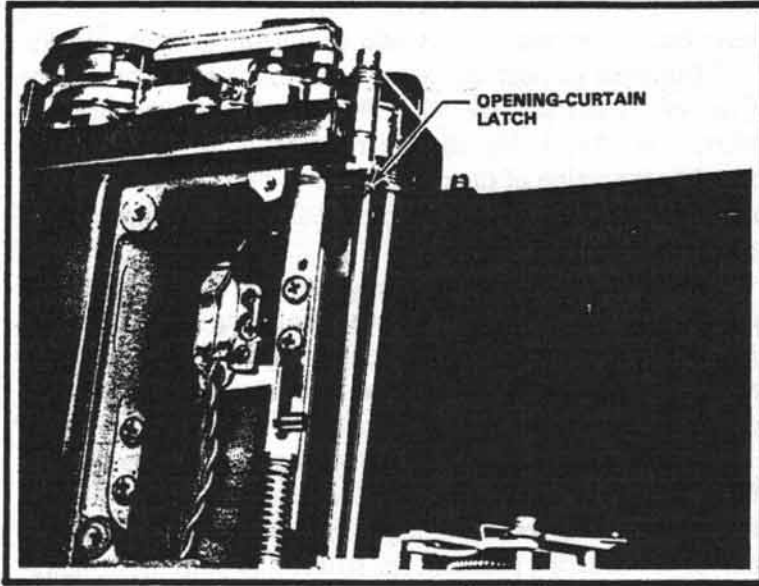

Figure 97

OPERATION OF THE MIRROR CAGE

With the mirror cage removed, try cocking the shutter. Then, push down the release shaft. What happens? Nothing should happen -- the shutter should not release.

Why? Remember, in the SLR the mirror releases the shutter. So, without the mirror cage, there's nothing to release the opening curtain.

To operate the shutter, you'll have to simulate the mirror-cage operation. Continue holding down the release shaft. Then, push the opening-curtain latch, Fig. 97, toward the back of the camera. The shutter should release.

Looking at the side of the mirror cage, you can locate the part which normally actuates the opening-curtain latch -- the opening-curtain striker, Fig. 98. As the mirror reaches the taking position, the opening-curtain striker swings toward the back of the mirror cage. The opening-curtain striker then comes against the opening-curtain latch, Fig. 90, to free the opening curtain.

Let's now check the operation of the mirror cage. Notice the lug on the mirror-lifting lever, Fig. 98. The mirror latch should now be engaged with this lug. If the mirror latch isn't engaged with the lug, try pushing the mirror-tensioning lever

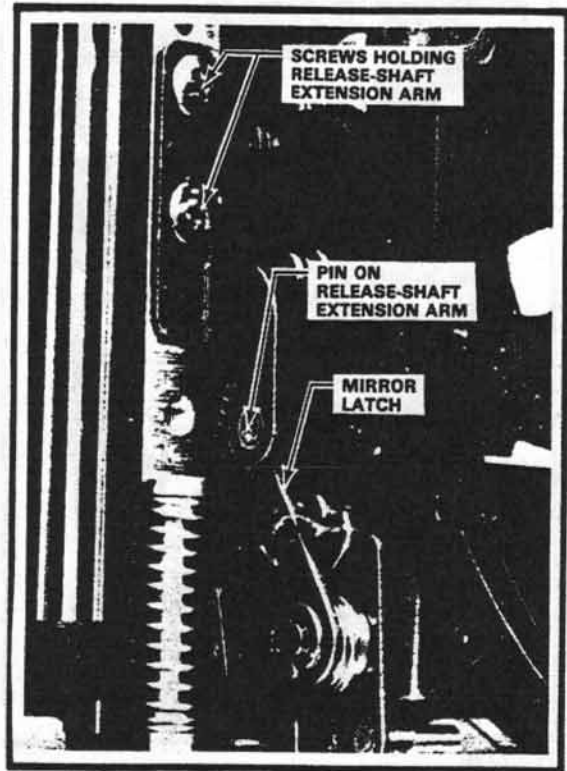

Figure 96

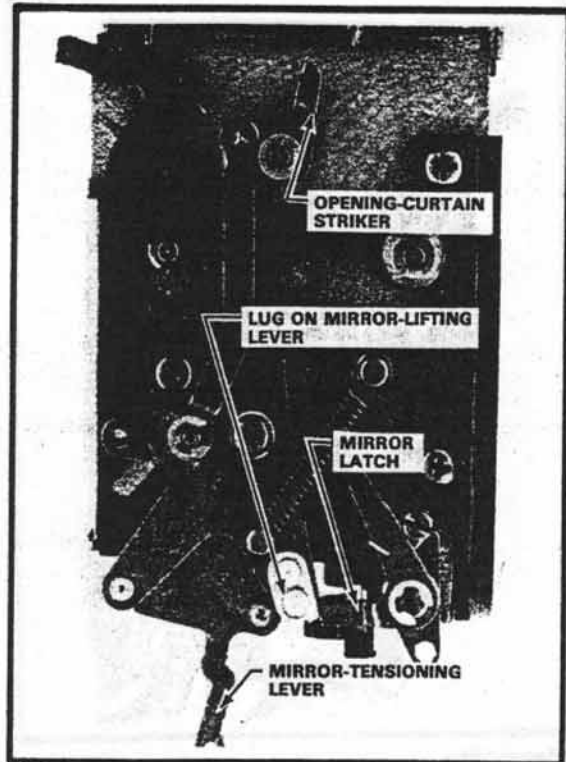

Figure 98

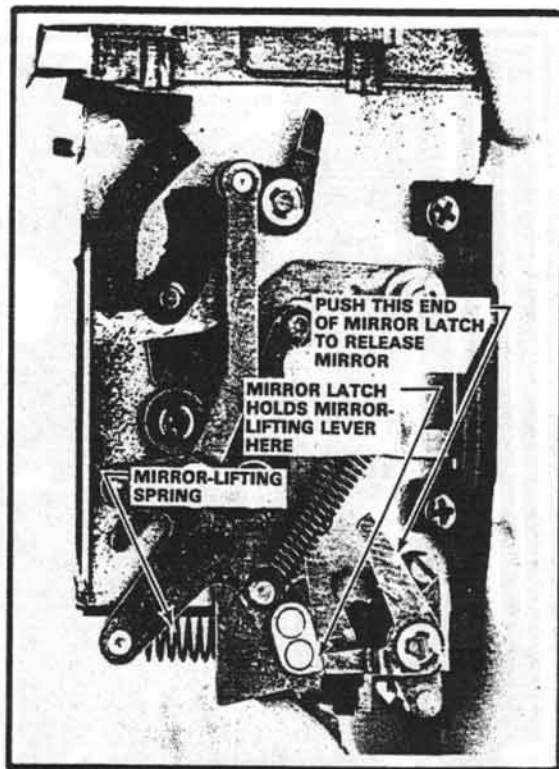

Figure 99

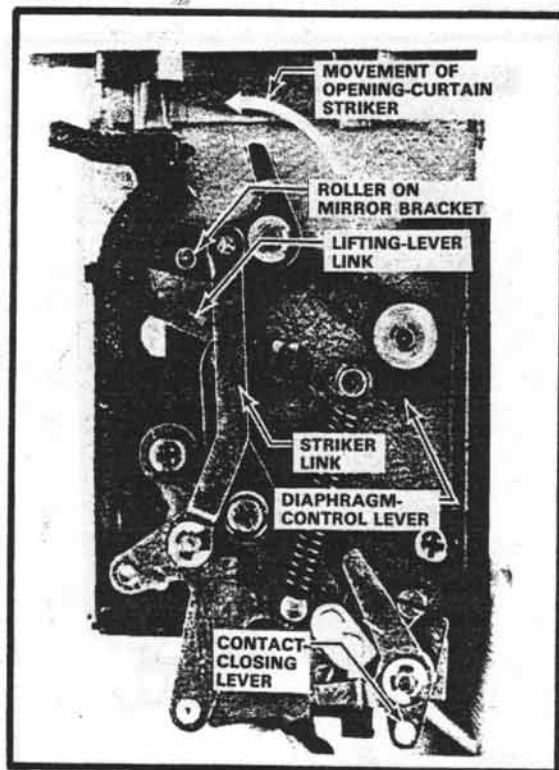

Figure 100

The spring that returns the mirror – the mirror-return spring – is inside the mirror cage. The rod upon which the mirror pivots passes through the center of the mirror-return spring.

toward the back of the mirror cage -- the mirror latch should then drop into engagement with the lug. Normally, the tensioning-lever spring, Fig. 88, would push back the mirror-tensioning lever and allow the mirror latch to engage.

Next, push the mirror-tensioning lever toward the front of the mirror cage, Fig. 99. You're now simulating the action of the mirror-cocking lever, Fig. 88. Pushing the mirror-tensioning lever toward the front of the mirror cage tensions the mirror-lifting spring, Fig. 99.

One end of the mirror-lifting spring hooks to the mirror-tensioning lever; the other end hooks to the mirror-lifting lever. So, if you're holding the mirror-tensioning lever toward the front of the mirror cage, the mirror-lifting spring tries to actuate the mirror-lifting lever. However, the mirror-lifting lever can't as yet move -- it's held by the mirror latch, Fig. 99.

Continue to hold the mirror-tensioning lever toward the front of the mirror cage, Fig. 99 (normally, the mirror-catch lever, Fig. 88, holds the mirror-tensioning lever). Now, simulate the action of the release shaft -- push down the end of the mirror latch, Fig. 99. The mirror should then move to the taking position.

A downward-projecting roller on the upper end of the mirror-lifting lever comes against the lifting-lever link, Fig. 100. And the lifting-lever link comes against a roller on the mirror bracket. So the lifting-lever link drives the mirror to the taking position.

Also observe the action of the opening-curtain striker, Fig. 100. The striker link couples the opening-curtain striker to the mirror-lifting lever. As the mirror-lifting lever drives the mirror to the taking position, the striker link pulls the opening-curtain striker in a counterclockwise direction. The upper end of the opening-curtain striker then swings toward the back of the mirror cage to release the opening curtain.

Notice that you must continue holding the mirror-tensioning lever toward the front of the mirror cage. If you release the mirror-tensioning lever, the mirror returns to the viewing position. You can now see why the mirror remains in the taking position for as long as the mirror-catch lever, Fig. 88, holds the mirror-tensioning lever.

Two other actions take place as the mirror rises: the FP-sync contacts close and the diaphragm stops down to the taking aperture. You can see the diaphragm-control lever under the mirror-lifting lever, Fig. 100. As the mirror rises, a downward-projecting roller on the mirror-lifting lever comes against the left-hand end of the diaphragm-control lever. The right-hand end of the diaphragm-control lever then moves up, allowing the diaphragm to close.

The mirror-lifting lever also closes the FP-sync contacts. As the mirror rises, notice how the lug on the mirror-lifting lever comes against the contact-closing lever, Fig. 100. The mirror-lifting lever drives the contact-closing lever clockwise. And the pin on the contact-closing lever closes the FP-sync contacts.

You should spend some time simulating the operation. Why? The operation of the mirror cages in other SLR's is basically the same. Also, by operating the mirror cage, you can locate the latching points. Lubricate each of the latching points with a light-grease lubricant.

REMOVING THE MIRROR-COCKING LEVER

You've seen that you can remove the mirror cage without taking out the mirror-cocking lever. So, if there's a mirror-cage problem, you can save a little time by leaving the mirror-cocking lever in place. However, you should remove the mirror-cocking lever if you're going further in the disassembly.

Why? When you try cocking and releasing the shutter, you may find that the mirror-cocking lever causes a bind. Since you've removed the shoulder screw, the mirror-cocking lever can bind against the mirror-return gear. As a result, you can't complete the cocking stroke.

Having to hold down the mirror-cocking lever as you cock the shutter takes extra time -- time you want to save in making your tests and adjustments. You could replace the keyed washer and the shoulder screw to hold down the mirror-cocking lever. But it's just as easy to remove the mirror-cocking lever from the camera -- especially if you're going further in the disassembly.

Remove the E-ring which clips the slotted end of the mirror-cocking lever to the wind-gear post, Fig. 101. Then remove the washer, also shown in Fig. 101.

You still can't lift out the mirror-cocking lever; it catches against the mirror-return gear. So partially cock the shutter --until the end of the mirror-cocking lever clears the mirror-return gear. Then, lift out the mirror-cocking lever. Also remove the teflon sleeve which fits over the wind-gear post, Fig. 102; the shoulder of the teflon sleeve goes up and passes through the slotted end of the mirror-cocking lever.

It's a little easier to remove the mirror-cocking lever if you first take out the mirror-catch lever and the mirror-return gear. However, unless you're going through a complete disassembly, you won't have to remove these parts. You can often save a little time by leaving the mirror-catch lever and the mirror-return gear in place.

TRANSPORT-RELEASE SYSTEM

As you operate the camera with the mirror cage removed, you'll notice that it takes two steps to release the shutter:

1. You must hold down the release shaft.
2. You must disengage the opening-curtain latch.

Why the two steps? Focal-plane SLR's have to latch the curtains at two points. First, the curtains must be latched to the wind mechanism. The wind mechanism can then advance the curtains to the cocked position. But, in order for the curtains to release, there must be a way to disengage the curtains from the wind mechanism.

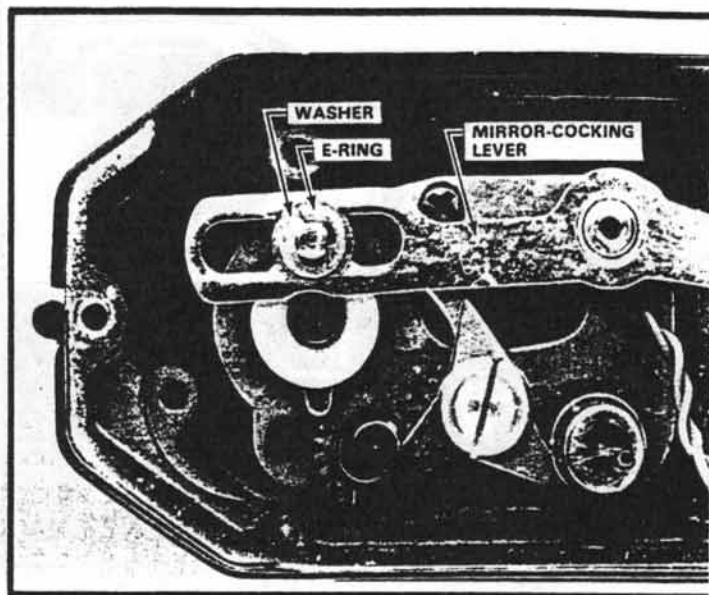

Figure 101

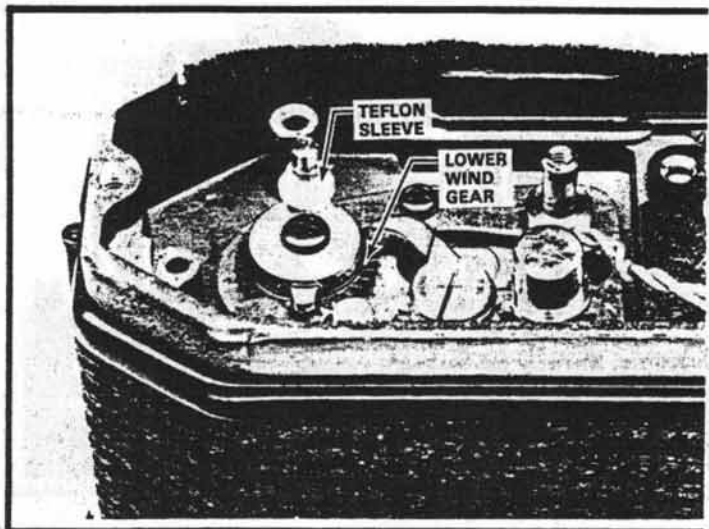

Figure 102

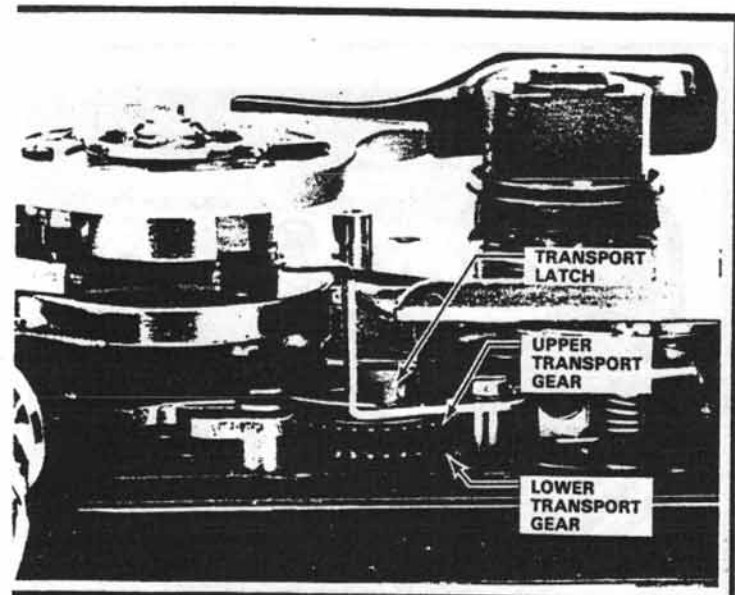

Figure 103

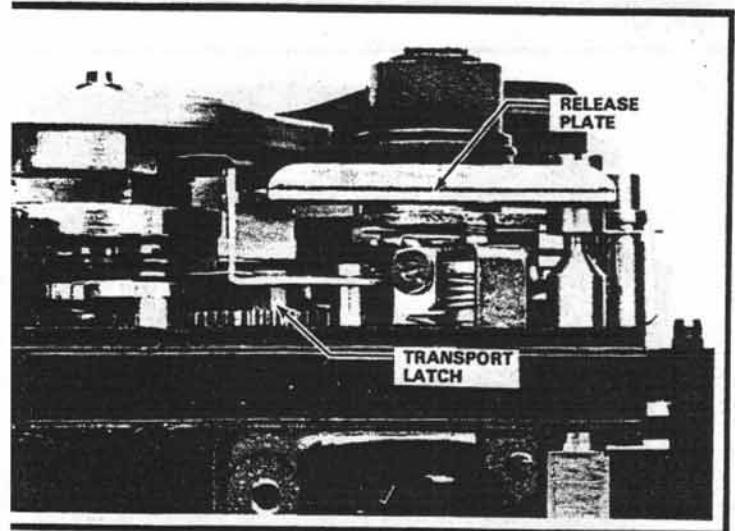

Figure 104

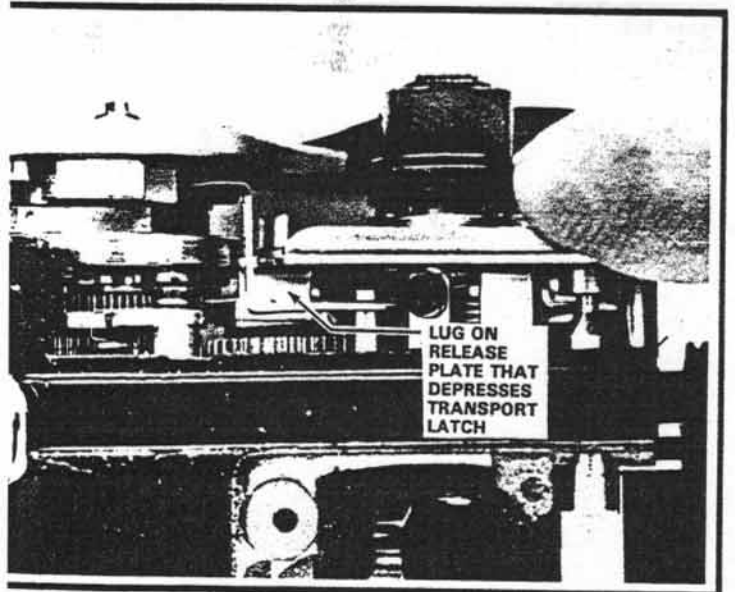

Figure 105

Secondly, the opening curtain must be latched by the opening-curtain latch. If it weren't for the opening-curtain latch, the curtains would release as soon as they were disengaged from the wind mechanism. That's not what you want. Remember, in an SLR, the mirror releases the opening curtain. If the opening curtain didn't wait for the mirror, the mirror would still be in the aperture during the exposure.

The design and operation of the opening-curtain latch remain pretty consistent in different SLR's. But the transport-release systems -- the systems that disengage the curtains from the wind mechanisms -- vary considerably. However, Spotmatic cameras (and pre-Spotmatic Pentax SLR's) have used the same transport-release system throughout the many different models.

Pentax Spotmatics use two separate gears to advance the curtains, Fig. 103. In Fig. 103, we've used the term **transport gears**. However, you'll also see the gears referred to as the "clutch gears," the "intermediate gears," and the "spill gears." "Intermediate gears" and "spill gears" are both Pentax terms -- the terms you'll see if you're looking at a Pentax parts list. But "transport gears" or "transport-release gears" may be more consistent with the names for parts performing similar functions in other camera designs.

During the wind cycle, the wind mechanism rotates the **lower transport gear**. And the lower transport gear turns the **upper transport gear**. Right now, the **transport latch** locks the two transport gears together, Fig. 104. You'll also see the transport latch referred to as the "clutch latch" or, in Pentax manuals, the "spill."

The upper transport gear engages the opening-curtain wind gear. So, as the wind mechanism rotates the lower transport gear, the upper transport gear draws the curtains to the cocked position.

To release the shutter, you must first disengage the upper transport gear from the lower transport gear. The lower transport gear remains engaged with the wind mechanism. But the upper transport gear must be free to rotate with the opening-curtain wind gear as the opening curtain moves in the release direction.

In Fig. 105, notice what happens when you depress the release shaft. The release plate (attached to the upper end of the release shaft) pushes down the transport latch. The transport latch then disengages from the upper transport gear. Now, the upper transport gear is free to rotate -- even though the lower transport gear stays in position.

We'll go through the disassembly and timing of the transport-release system a little later. You'll then see more clearly how the transport gears operate. For now, you might just try operating the camera while watching the transport gears. Notice how both gears turn together during the cocking cycle. But, when you release the shutter, only the upper transport gear rotates.

Pentax K1000

contents

55	SPEED-CONTROL SYSTEM
58	SLOW SPEEDS IN THE PENTAX
61	ADJUSTING THE PALLET-DISENGAGING ACTION
62	REMOVING AND CLEANING THE SPEEDS ESCAPEMENT
62	REMOVING THE SPEED SELECTOR
64	WIND-GEAR OPERATION
65	ADJUSTING THE OVERTRAVEL OF THE OPENING-CURTAIN WIND GEAR
65	ADJUSTING THE CURTAIN BRAKE
68	REMOVING THE SHUTTER-COCKED INDICATOR AND THE RELEASE PLATE
70	REMOVING THE WIND DRIVER
72	REMOVING THE SUPPORT-SHAFT ASSEMBLY
74	OPERATING THE SHUTTER WITH THE WIND-LEVER PARTS REMOVED
76	REMOVING THE TRANSPORT GEARS
78	MINOR AND MAJOR OVERHAUL
80	CHECKING CURTAIN TIMING
81	DISASSEMBLY TO REMOVE THE CURTAINS
86	REMOVING THE TAKE-UP ROLLERS
86	REMOVING THE WINDING ROLLERS
89	REPLACING THE SHUTTER CURTAINS
91	APPLYING THE INITIAL TENSIONS
92	TIMING THE CURTAIN-WIND GEARS
97	REPLACING THE MIRROR-RETURN GEAR AND THE WINDING-ROLLER PINION
99	REPLACING THE TRANSPORT GEARS
101	REPLACING THE SPEED-SELECTOR ASSEMBLY
103	SETTING THE CURTAIN TENSIONS
106	SHUTTER-SPEEDS ADJUSTMENTS IN THE SPOTMATIC
107	REMOVING THE WIND SHAFT AND TAKE-UP SPOOL
109	REPLACING THE SPROCKET IN THE K1000



Section 3

SPEED-CONTROL SYSTEM

In most respects, the Pentax speed-control system is representative of focal-plane SLR's. But the Pentax has one unique twist. Most focal-plane shutters use the closing-curtain latch for the bulb function. Not the Pentax -- the Pentax has a separate **bulb lever**.

Locate the closing-curtain latch and the bulb lever at the front of the speed-selector assembly, Fig. 106. The top section of the bulb lever serves as a cam follower; it comes against the **bulb cam**, Fig. 106. At the bulb setting, Fig. 106, a cutout in the bulb cam faces the bulb lever.

Try pushing down the release shaft as you watch the bulb lever. Notice how the bulb lever swings toward the bulb cam. You can see how the release shaft controls the bulb lever in Fig. 107. The tail of the bulb lever just rides against the release shaft. When the release shaft moves down, its groove allows the spring-loaded bulb lever to rotate clockwise.

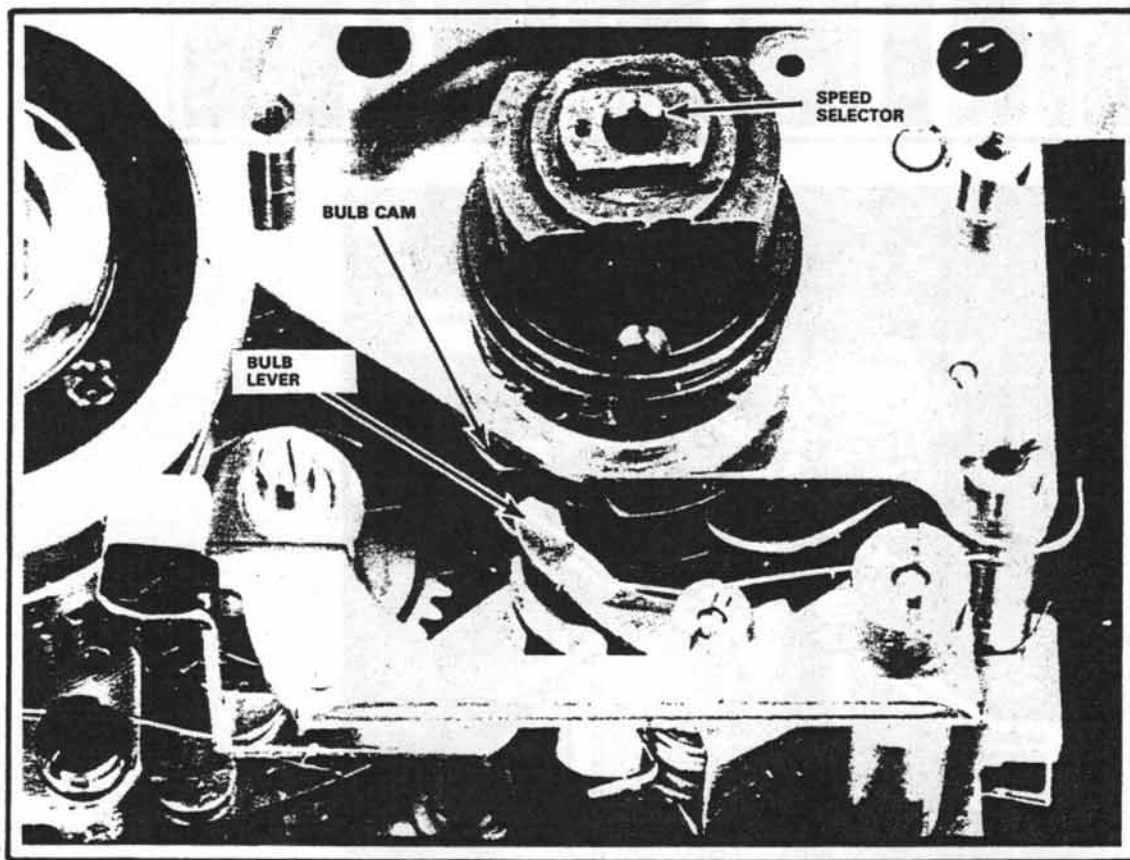

Figure 106



Pentax K1000

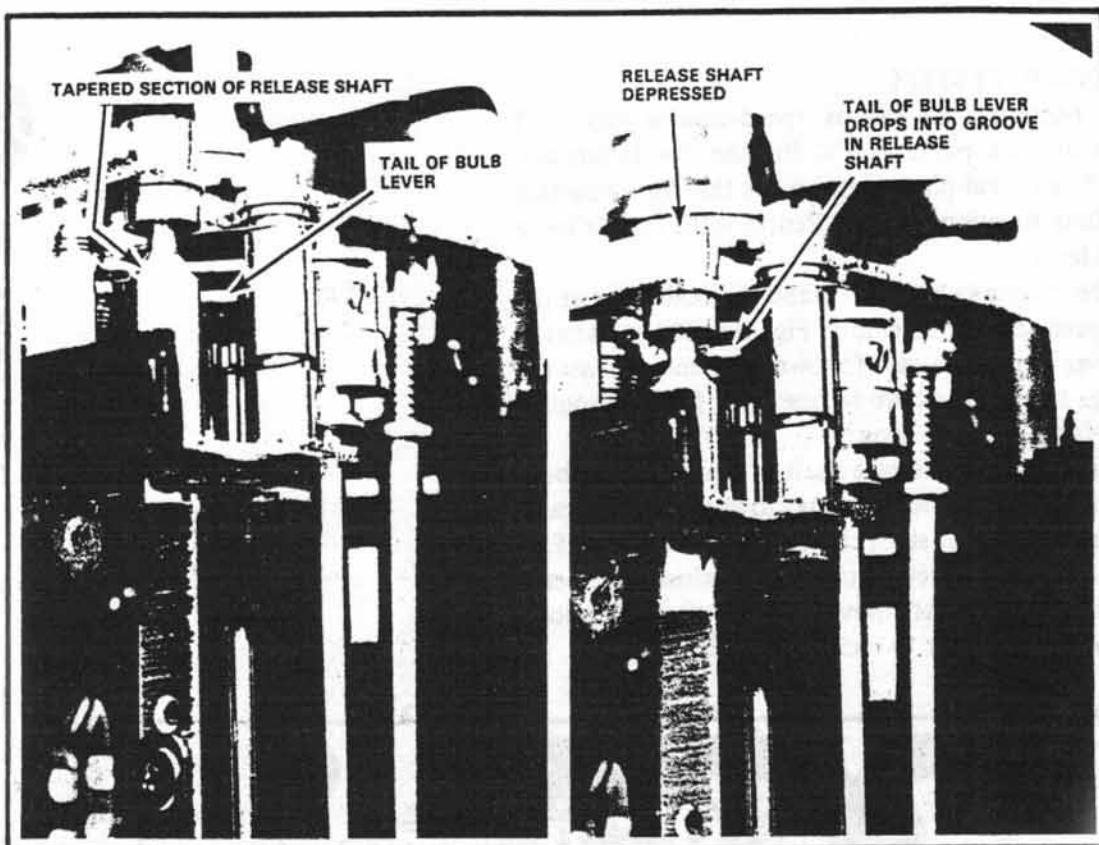

Figure 107

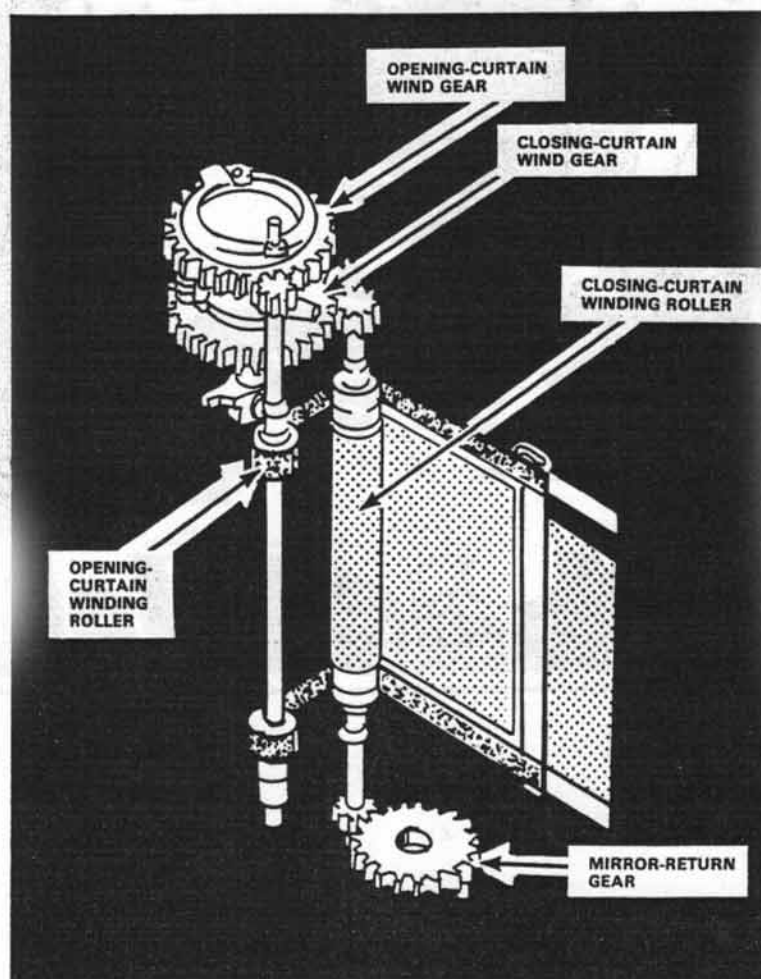

Figure 108

The latching end of the bulb lever then swings into the path of the closing-curtain wind gear. Right now, it's a little difficult to see the curtain-wind gears. But the drawing, Fig. 108, shows how the curtain-wind gears control the curtains.

Notice in Fig. 108 that the opening-curtain wind gear sits above the closing-curtain wind gear. The closing-curtain wind gear engages the pinion of the closing-curtain winding roller. Stopping the rotation of the closing-curtain wind gear then stops the movement of the closing curtain.

With the release shaft depressed, the bulb lever engages a lug on the closing-curtain wind gear. The bulb lever then stops the rotation of the closing-curtain wind gear *before* the closing curtain can enter the aperture.

The shutter remains open as long as the bulb lever engages the lug on the closing-curtain wind gear. However, when the release shaft returns to its rest position, it pushes the bulb lever out of engagement with the closing-curtain wind gear. In Fig. 107, you can see the tapered section of the release shaft -- this section comes against the bulb lever to free the closing curtain.

Now, try setting the speed selector to an instantaneous-speed setting. As you depress the release shaft, notice how the bulb cam blocks the bulb lever, Fig. 109. The bulb cam then prevents the bulb lever from swinging into engagement with the closing-curtain wind gear.

Yet the speed-control system must still hold back the closing curtain to provide a slit. What part now holds the closing-curtain wind gear? It's the **closing-curtain latch**, Fig. 109.

The cam-follower end of the closing-curtain latch comes against the release cam. You can just see the release cam under the bulb cam in Fig. 109. As you cock the shutter, notice how the release cam rotates clockwise.

While still watching the release cam, release the shutter. You should be able to see the release cam spin in a counterclockwise direction as the opening curtain moves across the aperture. Notice that the release cam always turns with the opening curtain -- both in the cocking and releasing directions. That's because the release cam couples directly to the opening-curtain wind gear.

Consider now that the opening curtain is moving across the aperture in the release direction. And the release cam is spinning counterclockwise. The release cam then strikes the closing-curtain latch. That disengages the closing-curtain latch to free the closing curtain. As you observe this action, you can see how the Pentax accomplishes one of the basic characteristics of focal-plane shutters:

The opening curtain releases the closing curtain.

The shutter speed depends on how far the opening curtain travels before releasing the closing curtain. At a full-aperture speed, the opening curtain completely crosses the aperture; the release cam then strikes the closing-curtain latch. But at a slit-width speed, the opening curtain is still in the aperture when

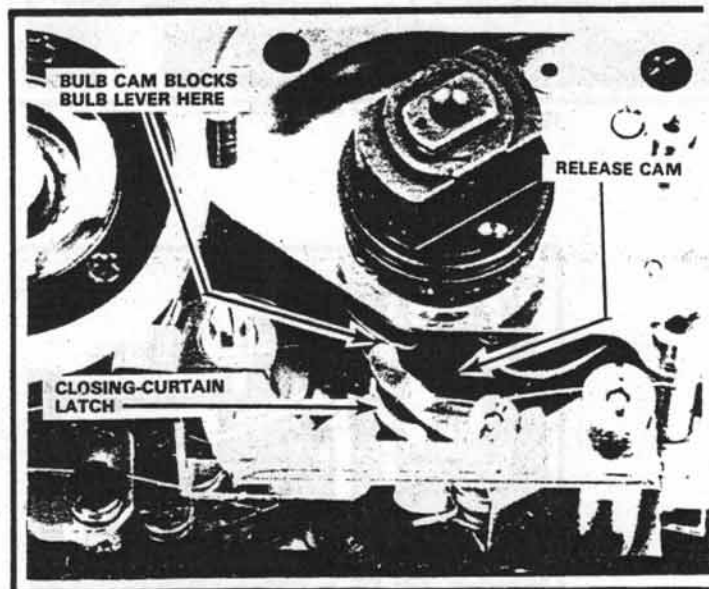

Figure 109 1-second setting

the closing curtain releases. The two curtains then form a slit which "wipes" the exposure onto the film.

How does the opening curtain know when to release the closing curtain? You give the camera this information when you set the shutter speed. Try watching the release cam as you rotate the speed selector clockwise (to the slit-width speeds). You can then see the movement of the release cam as the speed selector turns.

The speed selector just positions the release cam according to the shutter-speed setting. That decides how far the opening curtain must travel before releasing the closing curtain. At the 1/1000-second setting, for example, the opening curtain barely starts to move when the release cam strikes the closing-curtain latch. Yet at 1/60 second, the opening curtain completely crosses the aperture before the closing curtain releases.

As is typical, your slit-width adjustment is on the closing-curtain latch. Locate the setscrew and the locking ring at the front of the closing-curtain latch, Fig. 110. Both parts should be locked in place with red lacquer.

The slit-width adjustment has its greatest effect on the fastest speeds. After loosening the locking collar, you can turn the setscrew. Turning the setscrew repositions the closing-curtain latch. If you turn the setscrew clockwise, the closing-curtain latch moves closer to the release cam. The release cam then strikes the closing-curtain latch sooner, giving you a faster shutter speed. We'll go through the shutter-speed-adjustment sequence after you've covered the shutter mechanism.

SLOW SPEEDS IN THE PENTAX

We mentioned that 1/60 second is the fastest full-aperture speed -- the opening curtain completely crosses the aperture before releasing the closing curtain. That's also true of all the speeds slower than 1/60 second. But another part comes into play -- the **speeds escapement**.

The speeds escapement sits at the bottom of the camera, Fig. 111. At the speeds of 1/30 second and slower, the speeds escapement holds back the closing curtain -- *after* the closing curtain has been released by the opening curtain. Your shutter-speed setting determines how long the speeds escapement holds the closing curtain.

Two rods -- the **retard rod** and the **pallet rod**, Fig. 111 --connect the speeds escapement to cams under the speed selector. To check the slow-speed operation, start with the speed selector at the bulb position, Fig. 106. Then, rotate the speed selector counterclockwise (as seen from the top) to the first click-stop position -- that's the 1-second setting.

Now, cock the shutter. Push down the release shaft and trip the opening-curtain latch. While watching the action from the front of the shutter, you can see the closing curtain creep toward the aperture. The closing curtain is now pushing its way past the retarding action of the speeds escapement.

Just before the closing curtain reaches the aperture, though, it's released by the speeds escapement. The closing

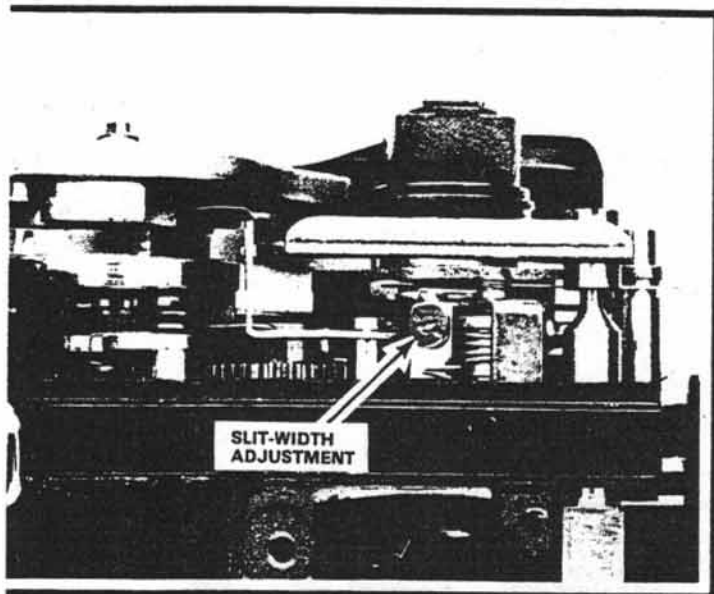

Figure 110

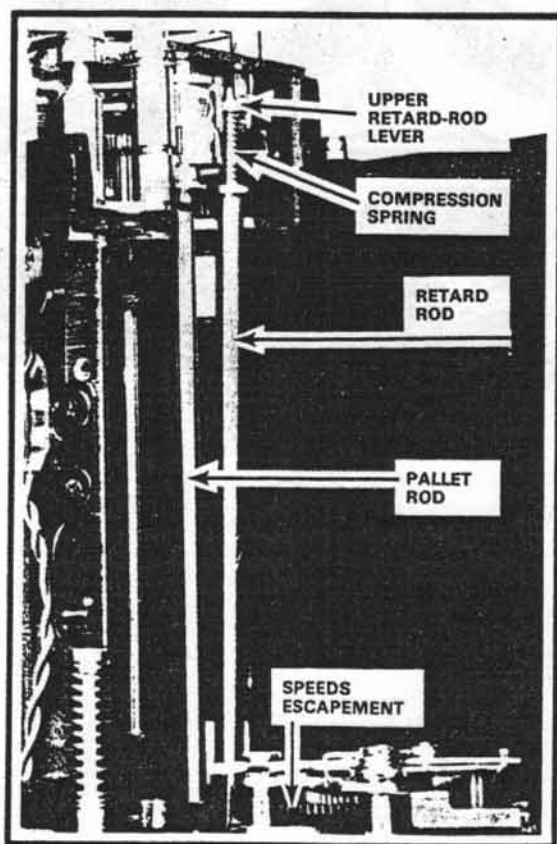

Figure 111

curtain then fires across the aperture to complete the exposure.

Right now, it's a little difficult to see exactly how the speeds escapement holds back the closing curtain. But the **upper retard-rod lever**, Fig. 111, engages a lug on the closing-curtain wind gear. As the closing-curtain wind gear turns, it pushes the upper retard-rod lever toward the back of the camera.

The upper retard-rod lever then turns the retard rod in a clockwise direction (as seen from the top). But the speeds escapement resists this clockwise movement. Why? Because the lower retard-rod lever couples to a fork in the first gear segment of the speeds escapement, Fig. 112. The length of the exposure depends on how long it takes for the closing-curtain wind gear to push its way past the upper retard-rod lever.

Besides being able to rotate clockwise or counterclockwise, the retard rod can move up and down. A compression spring, Fig. 111, pushes down the retard rod. The upper retard-rod lever is then in the path of the closing-curtain wind gear.

But consider what happens when you cock the shutter. The closing-curtain wind gear rotates in the direction that draws the curtains to the cocked position -- opposite to the direction of rotation during the release cycle. If the shutter's at a slow-speed setting, the upper retard-rod lever sits in the way of the closing-curtain wind gear.

The retard-drive lug on the closing-curtain wind gear must then get past the upper retard-rod lever. Yet the retard-drive lug can't simply push aside the upper retard-rod lever -- that would be forcing the retard rod to rotate in the wrong direction. Instead, a sloped surface on the retard-drive lug just passes under the upper retard-rod lever as the closing-curtain wind gear rotates to the cocked position. That pushes up the retard rod, against the pressure of the compression spring.

Once the retard-drive lug clears the upper retard-rod lever, the compression spring pushes down the retard rod. Now, the upper retard-rod lever is once again in the path of the retard-drive lug. You'll be able to see the action more clearly as you disassemble the curtain-wind gears. For now, try cocking the shutter at the 1-second setting; notice how the retard rod moves up during the cocking cycle. Then, when you reach the cocked position, the compression spring, Fig. 111, pushes down the retard rod.

The retard rod can also swing in and out -- toward you or away from you in Fig. 111. You can observe this movement by rotating the speed selector. Watch the retard rod, Fig. 111, as you turn the speed selector counterclockwise. Notice that the retard rod moves away from the speed selector when you go from the 1-second setting to the 1/2 setting.

Moving the retard rod away from the speed selector decreases the depth of engagement between the closing-curtain wind gear and the upper retard-rod lever. It then takes less time for the closing-curtain wind gear to push its way through the speeds escapement. And you get a faster shutter speed.

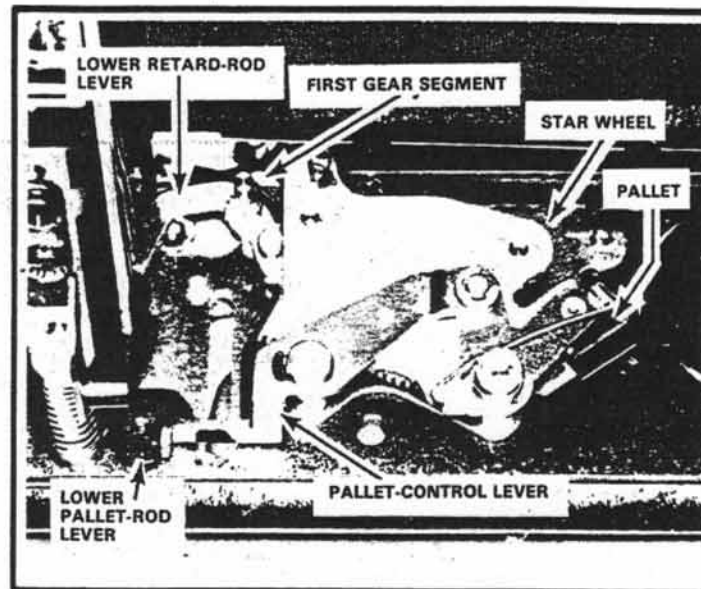

Figure 112

Continue turning the speed selector counterclockwise to the faster speed settings. You can then see the retard rod move further away from the closing-curtain wind gear. But you'll soon reach a setting at which the retard rod suddenly moves toward the closing-curtain wind gear -- that's the 1/15-second setting.

At 1/15 second, you again have full engagement between the closing-curtain wind gear and the upper retard-rod lever. However, at 1/15 second and 1/30 second, the pallet disengages from the star wheel, Fig. 112.

To check the pallet action, first cock the shutter. Then, watch the pallet, Fig. 112, as you turn the speed selector counterclockwise from the bulb setting. When you see the pallet move away from the star wheel, you've reached the 1/15-second shutter speed.

The pallet rod, Fig. 111, is the part that disengages the pallet. A cam follower at the top of the pallet rod, Fig. 113,

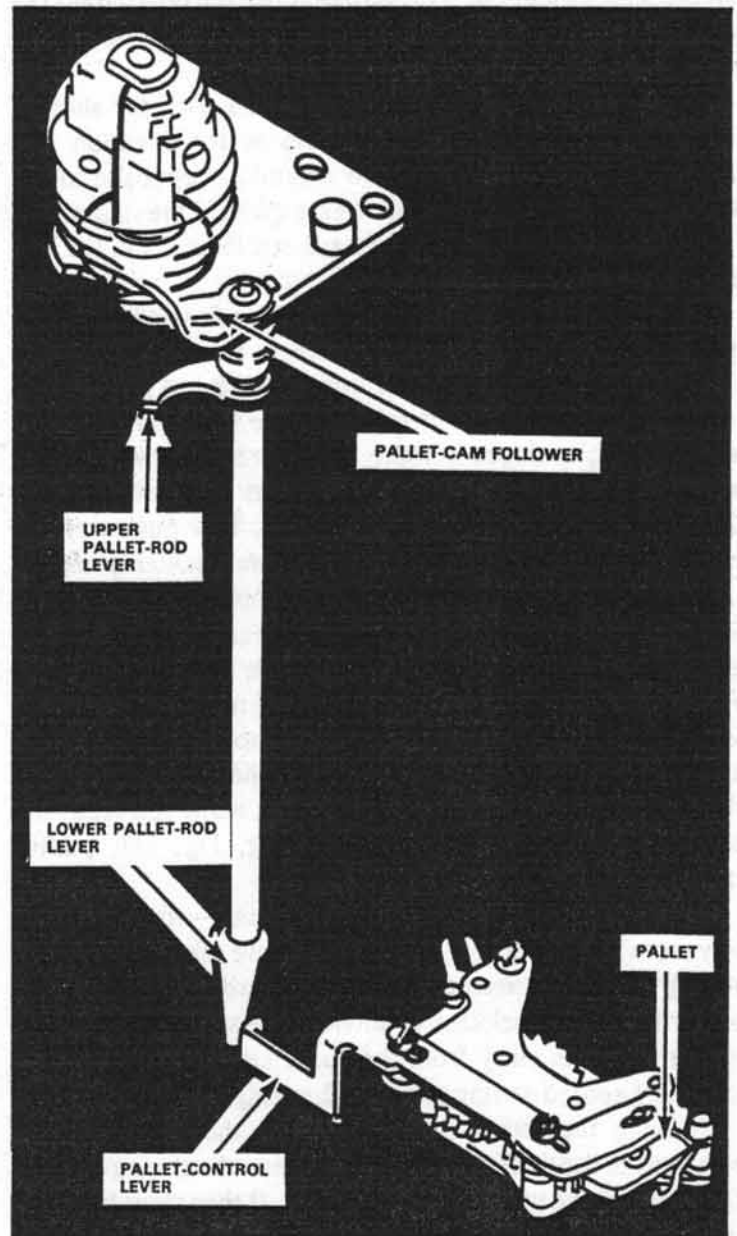

Figure 113

rides against the pallet-control cam. At 1/15 second, the pallet-control cam pushes the pallet rod counterclockwise, Fig. 113. The lower pallet-rod lever, Fig. 112 and Fig. 113, then pushes the pallet-control lever from left to right. And the pallet-control lever moves the pallet away from the star wheel.

We can now identify the speed ranges in the Pentax:

1/1000 - 1/125	slit width
1/60	full aperture, no retard
1/30 & 1/15	retard with no pallet
1/8 - 1 second	retard with pallet engagement

The pallet rod has one other job -- it disengages the pallet after the exposure. To check this action, try setting the shutter to the 1-second exposure (one click-stop counterclockwise from the bulb setting). Then, while watching the pallet, cock and release the shutter. At the end of the exposure, you should see the pallet disengage from the star wheel. The first gear segment may then return easily to its rest position.

Referring to Fig. 113, you can visualize how the closing curtain disengages the pallet. After the exposure, a pin on the closing-curtain wind gear strikes the upper pallet-rod lever. That drives the lower pallet-rod lever against the pallet-control lever, Fig. 113, to disengage the pallet.

You have adjustments both for the pallet-disengaging action and for the depth of retard engagement. To check the pallet-disengaging action, release the shutter at the 1-second setting. Listen for the "whirr" of the speeds escapement after the exposure.

If you hear the "whirr," you know that the pallet isn't disengaging properly; the first gear segment must then push its way against the pallet action while returning to the rest position. If you don't hear the "whirr" of the pallet after the exposure, you know that the pallet-disengaging adjustment is correct. We'll describe the adjustment technique in the next topic.

Changing the retard engagement provides your slow-speed adjustment. The slow-speed adjustment is similar to the slit-width adjustment -- a setscrew with a locking collar, Fig. 114. The setscrew accessible from the back of the camera, Fig. 114, controls the depth of engagement between the upper retard-rod lever and the closing-curtain wind gear. By turning the setscrew clockwise, you get more engagement -- and, as a result, a slower speed. We'll cover the slow-speed adjustments in the section, "Adjusting the Shutter Speeds."

ADJUSTING THE PALLET-DISENGAGING ACTION

Let's say that you hear the tell-tale "whirr" of the pallet after the 1-second exposure. Remember, the noise tells you that the pallet isn't being completely disengaged. The pallet rod isn't pushing the pallet-control lever far enough from left to right, Fig. 113.

You can then adjust the position of the upper pallet-rod

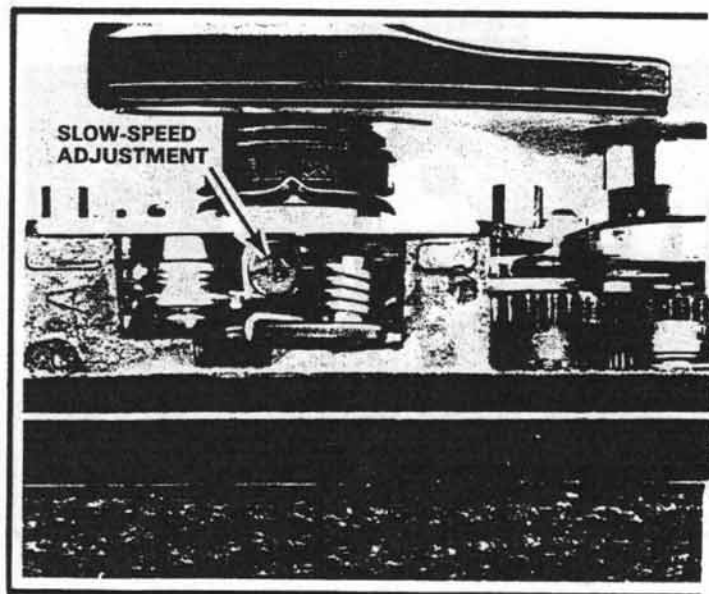

Figure 114

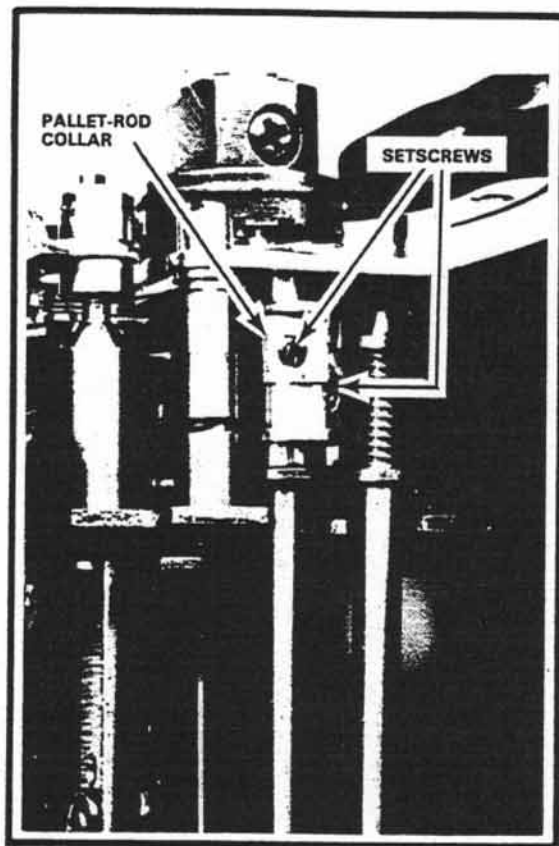

Figure 115

lever, Fig. 113. Locate the two setscrews in the pallet-rod collar, Fig. 115. After loosening these setscrews, you can shift the collar to reposition the upper pallet-rod lever.

Make the pallet-disengaging adjustment with the shutter released at the 1/15-second setting. Now, loosen the two setscrews, Fig. 115. Using your finger or a screwdriver blade, push the lower pallet-rod lever and the pallet-control lever as far as they'll go to the right, Fig. 112. This movement disengages the pallet.

Continue holding the lower pallet-rod lever and the pallet-control lever. Then, rotate the pallet-rod collar, Fig. 115, as far as it will go in a clockwise direction (as seen from the top). Tighten the two setscrews to lock the pallet-rod in place.

REMOVING AND CLEANING THE SPEEDS ESCAPEMENT

You'll normally want to remove the speeds escapement -- even for routine cleaning and lubrication. Take out the two screws at the bottom of the body casting, Fig. 116. Then, lift out the speeds-escapement assembly.

In earlier Spotmatic models, the tripod socket doesn't have the flat side, Fig. 116. The tripod socket then prevents you from reaching one of the speeds-escapement screws. So, to remove the speeds escapement, you must first take out the tripod socket.

You can now clean and lubricate the speeds escapement. Clean the speeds escapement as a unit. One way to clean the unit is to swish the speeds escapement through an alcohol bath. Operate the speeds escapement a few times by pushing the first gear segment in a counterclockwise direction. Then, use an air blower to dry the speeds escapement.

How about lubrication? Some technicians prefer dry moly; others prefer shutter oil. But Pentax recommends using shutter oil to lubricate the speeds escapement. Place a tiny drop of shutter oil at each of the pivot points (where the pivots pass through their bearings).

When you replace the speeds escapement, make sure that the fork in the first gear segment straddles the pin on the lower retard-rod lever, Fig. 112. Also be certain that the pallet-control lever sits against the end of the lower pallet-rod lever, Fig. 112.

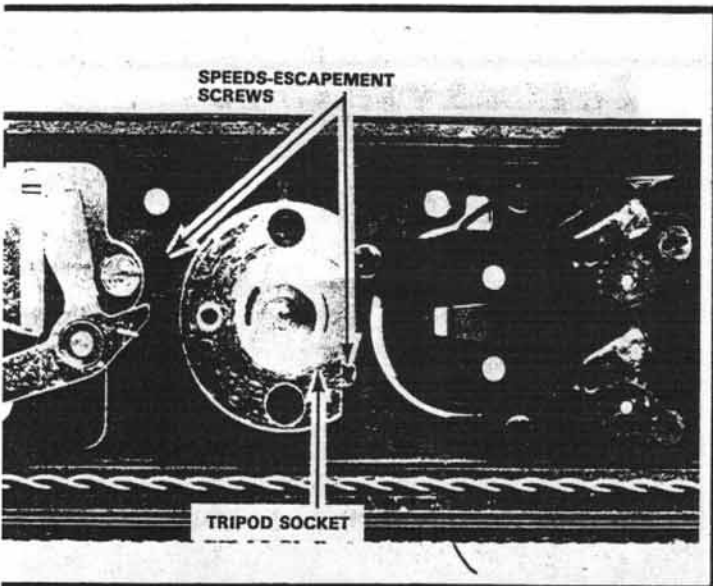

Figure 116

REMOVING THE SPEED SELECTOR

To clean the curtain-control parts, you'll have to go further in the disassembly -- you'll have to remove the speed selector. Although you could probably clean the mechanism without further disassembly, you would have trouble reaching the lubrication points.

Be sure you keep the camera upright as you remove the speed selector -- there will be some loose parts. Take out the two cross-point screws shown in Fig. 117 (notice that the screw closer to the center of the camera is larger in size). Then,

unscrew the support post, Fig. 117, and lift out the speed-selector assembly.

NOTE: It's a little easier to remove and replace the speed selector with the wind lever removed. However, you don't have to remove the wind lever.

The release cam is now loose, Fig. 118. A slot in the release cam fits over a pin on the opening-curtain wind gear. Since the opening-curtain wind gear couples to the slot, the release cam always rotates as the opening curtain moves.

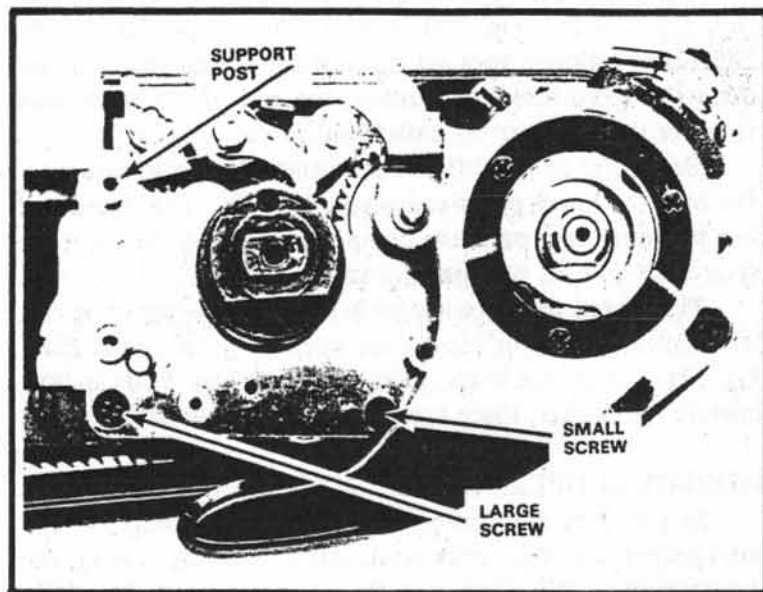

Figure 117

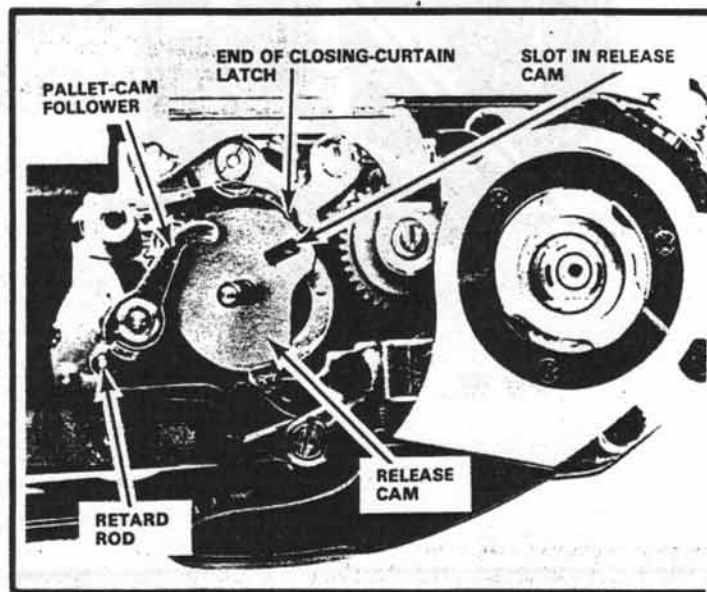

Figure 118

It's possible that the release cam stayed with the speed selector during disassembly. The shaft of the release cam fits through the speed-selector hole, Fig. 119. If the release cam in your camera did stay with the speed selector, separate the two parts now. The release-cam shaft is one of the critical cleaning-and-lubrication points in the Pentax.

The release-cam shaft must spin freely within the speed-selector hole. Why? Because the release cam rotates as the opening curtain crosses the focal-plane aperture. Any part which turns with the curtain movement must be able to travel freely. Otherwise, you'll get erratic curtain movement.

It's the speed-selector hole that gives the eccentric movement to the release cam as you change the speed setting; that's how the speed selector repositions the release cam for different slit widths. The edge of the release cam then strikes the end of the closing-curtain latch, Fig. 118, to free the closing curtain.

Also locate the upper end of the retard rod in Fig. 118. This end passes through the hole in the slow-speed coupler, Fig. 119. Another lever -- the slow-speed cam follower, Fig. 119 -- rides against the slow-speed cam in the speed-selector cam stack.

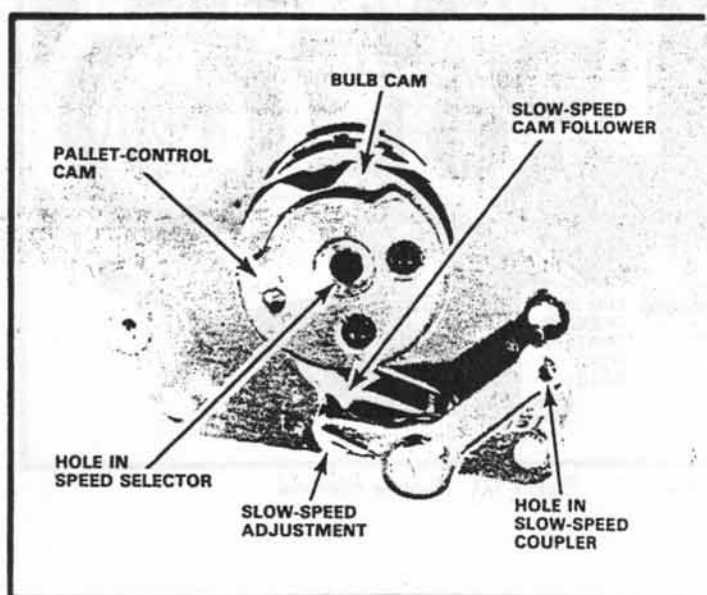

Figure 119 Bottom of speed selector

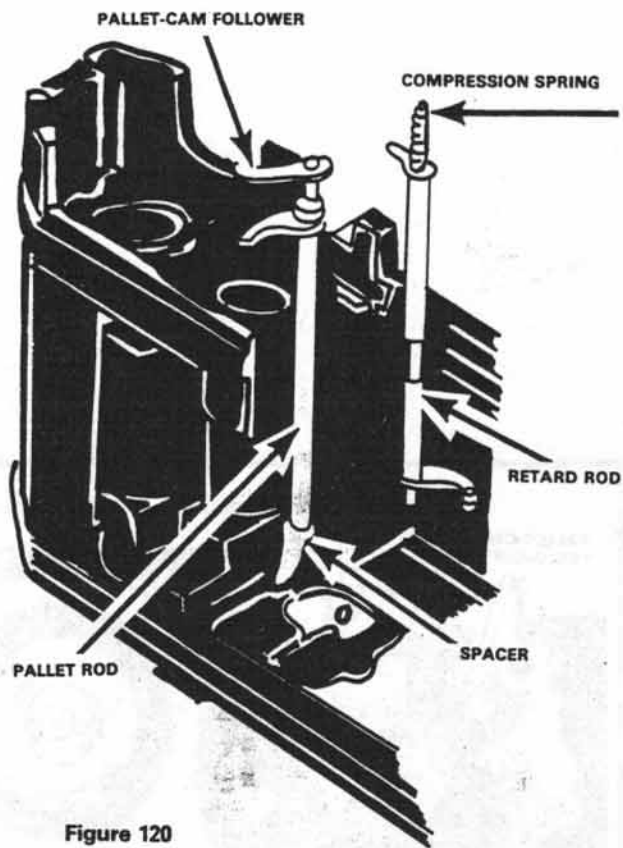

Figure 120

The slow-speed cam then positions the slow-speed cam follower according to the shutter-speed setting. In turn, the slow-speed cam follower positions the slow-speed coupler to control the retard rod. The slow-speed adjustment, Fig. 114 and Fig. 119, changes the relationship between the slow-speed cam follower and the slow-speed coupler. So, even though the slow-speed cam follower stays in the same position, you can move the retard rod to change the depth of engagement.

Proceeding with the disassembly, lift out the release cam, Fig. 118. Both rods -- the retard rod and the pallet rod -- are also loose. And each rod has a loose part on its upper end, Fig. 120.

The **pallet-cam follower** sits at the upper end of the pallet rod, Fig. 118 and Fig. 120. Notice that the shoulder of the pallet-cam follower goes up (toward the top of the camera). With the speed selector in place, the end of the pallet-cam follower rides against the **pallet-control cam**, Fig. 119.

Be careful as you lift out the pallet rod -- a loose spacer fits over the lower pallet-rod pivot, Fig. 120. The retard rod has just one loose part, the compression spring. Lift out the retard rod with its compression spring.

There's one more loose part in the camera -- the brass collar which fits over the pin on the opening-curtain wind gear, Fig. 121. Lift off the brass collar to prevent loss. You can now operate the shutter; there aren't any more loose parts.

WIND-GEAR OPERATION

As you cock the shutter, notice that the opening-curtain wind gear rotates in a clockwise direction, Fig. 121. The lug on the opening-curtain wind gear then comes against the **wind-gear stop plate**, Fig. 122. And the opening-curtain latch drops into engagement with the opening-curtain latching cam.

During the cocking cycle, a downward-projecting pin on the opening-curtain wind gear engages a lug on the closing-curtain wind gear. So, as the opening-curtain wind gear rotates clockwise, it carries the closing-curtain wind gear in the same direction. Both curtains then move simultaneously to the cocked position.

You can release the shutter by holding down the release shaft. Then, disengage the opening-curtain latch. Notice what happens now -- the shutter hangs open. Although the opening curtain crosses the aperture, the closing curtain remains held by the closing-curtain latch.

Without the release cam, there's nothing to disengage the closing-curtain latch. So the closing curtain remains in the cocked position. To release the closing curtain, use your tweezers and push the closing-curtain latch away from the closing-curtain wind gear, Fig. 122.

Fig. 121 and Fig. 122 also show the action of the shutter-cocked indicator. When the opening-curtain wind gear rotates to the cocked position, its small pin comes against the tail of

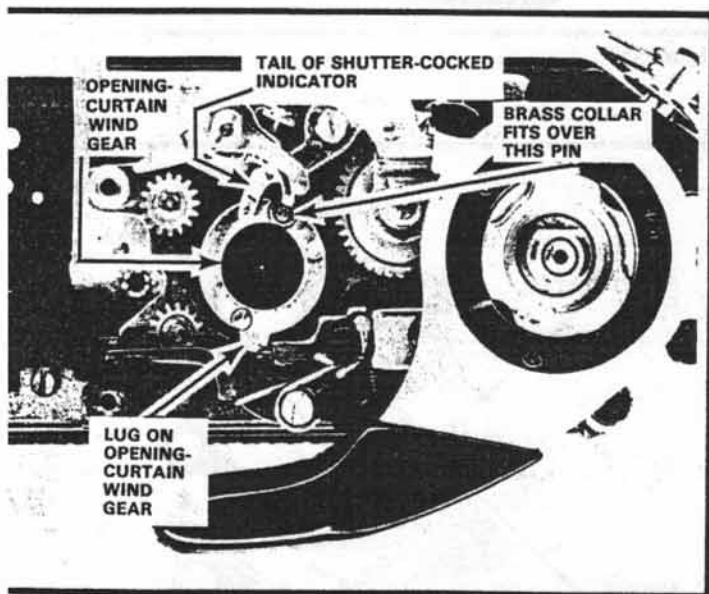

Figure 121 Shutter released

the shutter-cocked indicator. Now, the opening-curtain wind gear pushes the shutter-cocked indicator in a counterclockwise direction, Fig. 122. And the red section of the shutter-cocked indicator shows through the top-cover window.

When you release the shutter, the small pin on the opening-curtain wind gear moves away from the shutter-cocked indicator. A spring then returns the shutter-cocked indicator to the position shown in Fig. 121. Now, the black section of the shutter-cocked indicator moves under the top-cover window.

ADJUSTING THE OVERTRAVEL OF THE OPENING-CURTAIN WIND GEAR

As you cock the shutter, the opening-curtain wind gear travels slightly further than necessary. This slight overtravel assures that the opening-curtain latch always drops into engagement -- even when the shutter gets a little dirty.

You can check the overtravel by cocking the shutter. Hold the wind lever fully advanced; the lug on the opening-curtain wind gear should then come against the wind-gear stop plate, Fig. 122. Now, allow the wind lever to return to its rest position. You should see the opening-curtain wind gear rotate slightly in the release (counterclockwise) direction before the opening-curtain latch drops into engagement.

So, with the shutter cocked, *there should be a slight space gap between the lug on the opening-curtain wind gear and the side of the wind-gear stop plate.* Fig. 122 points out the **0.2mm space gap**. If the space gap is less than 0.2mm, you don't have sufficient overtravel. A larger space gap means there's too much overtravel.

You can adjust the overtravel by repositioning the wind-gear stop plate, Fig. 122. Locate the **stop-plate positioning screw** in Fig. 122; this setscrew determines the position of the wind-gear stop plate.

To make an adjustment, first loosen the two screws holding the wind-gear stop plate. Then, turn the stop-plate positioning screw from the back of the camera, Fig. 123. The end of the stop-plate positioning screw shown in Fig. 123 should be sealed with red lacquer.

Turn the stop-plate positioning screw clockwise to decrease the space gap. The stop-plate positioning screw then pushes the wind-gear stop plate closer to the lug on the opening-curtain wind gear. To increase the space gap, turn the stop-plate positioning screw counterclockwise, Fig. 123. Then, hold the wind-gear stop plate, Fig. 122, against the stop-plate positioning screw. And tighten the two screws holding the wind-gear stop plate.

ADJUSTING THE CURTAIN BRAKE

Locate the **brake lever** in Fig. 122. The brake lever provides a cushioning action for the curtains. As the opening-curtain wind gear nears the released position, its lug must push

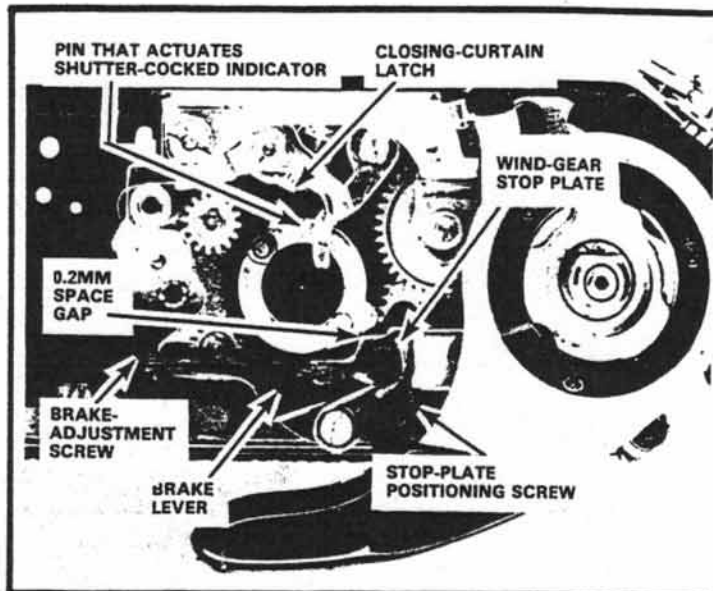

Figure 122 Shutter cocked

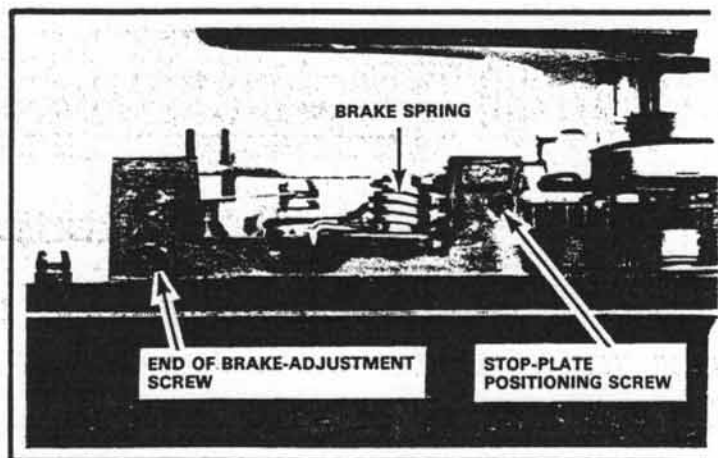

Figure 123

aside the brake lever. The wind-gear stop plate then stops the counterclockwise rotation of the opening-curtain wind gear, Fig. 121.

Without the brake lever, the opening-curtain wind gear would strike the wind-gear stop plate at top speed. That sudden stop would cause the opening-curtain wind gear to recoil, turning in a clockwise direction. And the opening curtain would bounce; it would reenter the focal-plane aperture after the exposure.

Most focal-plane shutters provide an adjustment on the amount of braking action. In the Pentax, a screw -- the **brake-adjustment screw**, Fig. 122 -- limits how far the brake lever can move toward the opening-curtain wind gear. By turning the brake-adjustment screw, you can then reposition the brake lever.

Moving the brake lever closer to the opening-curtain wind gear increases the braking action; moving the brake lever further from the opening-curtain wind gear decreases the braking action.

Let's say, for example, that you're getting curtain bounce. You can then increase the braking action. But you don't have to remove the speed selector to reach the brake adjustment. Rather, you can turn the brake-adjustment screw from the back of the camera, Fig. 123.

In Fig. 123, you're seeing the other end of the brake-adjustment screw (the end that screws into the body casting). Pentax provides a screwdriver slot in the threaded end of the screw to make the adjustment more convenient. As with most Pentax adjustments, there's red lacquer on the end of the screw, Fig. 123.

You can increase the braking action by turning the brake-adjustment screw in a clockwise direction, Fig. 123. But how do you know if you have curtain bounce? Many test instruments will provide this information. However, with practice, you can spot curtain bounce by watching the curtains during the release cycle.

Before describing the procedure, though, we should identify the two types of bounce:

1. **opening-curtain bounce**
2. **closing-curtain bounce.**

With opening-curtain bounce, the opening curtain bounces back into the aperture. That can cause an underexposed stripe running along one edge of the film frame. With closing-curtain bounce, though, you get an overexposed stripe. When the closing curtain bounces, it gives a reexposure to the edge of the film frame.

You've seen that the Pentax brake lever acts against the opening-curtain wind gear. There's no separate brake for the

closing curtain. Although many focal-plane shutters have separate brakes for the two curtains, the Pentax only needs one brake. That's because the upper pallet-rod lever also serves to cushion the closing curtain. Remember, the closing-curtain wind gear strikes the upper pallet-rod lever at the end of the release cycle.

So, in the Pentax, it's very unusual to have closing-curtain bounce. If the closing curtain is bouncing, the adjustment on the pallet-disengaging action, Fig. 115, is probably incorrect. But here's a general technique you can use to determine which curtain is bouncing:

Set the camera to the fastest shutter speed. Then, open the camera back and hold up the camera to a light source. Watch the closing side of the focal-plane aperture as you release the shutter.

If the closing curtain is bouncing, you should be able to see a stripe of light running along the closing side of the aperture. That's the reexposure. If the opening curtain is bouncing, you should be able to see a dark stripe running along the closing side of the aperture.

Again, you normally don't have to worry about closing-curtain bounce in the Pentax. But you may have to adjust the brake lever to correct the opening-curtain braking action. Let's consider that you're setting the brake adjustment from scratch. Here's a technique you can use:

Working from the back of the camera, turn the brake-adjustment screw in a counterclockwise direction to decrease the braking action. Keep turning the brake-adjustment screw until you see the gray stripe at the closing side of the aperture. You now have opening-curtain bounce.

Next, turn the brake-adjustment screw a small amount in a clockwise direction. And again check the braking action. You should see a smaller stripe, indicating that the bounce has decreased.

Keep turning the brake-adjustment screw clockwise in small amounts. Check the width of the stripe after each adjustment. When you can no longer see the stripe, you know that the opening curtain is bouncing to the edge of the focal-plane aperture; but the opening curtain isn't actually bouncing into the aperture to cause an underexposed stripe.

Now, rotate the brake-adjustment screw an additional 1/2 turn in a clockwise direction.

Besides eliminating curtain bounce, this procedure assures that you don't have excessive braking action. Too much braking action could stop the curtains with the closing-curtain bar still in the aperture.

REMOVING THE SHUTTER-COCKED INDICATOR AND THE RELEASE PLATE

Since the shutter-cocked indicator is quite soft, it's easily damaged. So you may wish to remove the shutter-cocked indicator early in the disassembly.

Just disconnect the spring from the side of the shutter-cocked indicator, Fig. 124. The spring may stay on the screwhead (the screw that supports the spring also holds one corner of the support-shaft assembly). But, as a safeguard against loss, you may wish to completely remove the spring.

Now, remove the screw shown in Fig. 124 and lift out the shutter-cocked indicator. Fig. 125 shows the spring for the shutter-cocked indicator still in place around the screwhead (notice in Fig. 125 that we've repositioned the camera; we now have the front of the camera facing us in order to more easily reach the parts at the front). The hooked end of the spring, Fig. 125, connects to the side of the support-shaft assembly; the curved end of the spring connects to the notch in the side of the shutter-cocked indicator.

Another part you can easily get out of your way is the release plate, Fig. 125. A nut holds the release plate to the release shaft. You can use a large, thin screwdriver to unscrew the nut. Or you can make a special tool out of an old screwdriver, such as the one shown in Fig. 126.

You don't really need the special tool to remove the release-plate nut. But the tool does have quite a few applications -- especially in making the shutter-speed adjustments, as we'll later describe.

Unscrew the nut, Fig. 125, and lift off the release plate. The hole in the end of the release plate passes over the teflon sleeve on the transport-gear screw, Fig. 127. Also notice that the hole which fits over the release shaft has two flat sides; the flat sides key to the two flat sides on the release shaft, Fig. 127.

You may be wondering why we removed the shutter-cocked indicator before taking out the release plate. Wouldn't the disassembly be easier if we reversed the sequence? It probably would. However, you'll now find that pushing the release shaft doesn't disengage the transport gears. To release the shutter, you'll have to use a small tool (such as a small screwdriver) and depress the transport latch, Fig. 127. That's a little more difficult (and slower) than simply depressing the release shaft.

So it's normal to replace the release plate first. You can then test the operation quickly and easily -- without worrying about the shutter-cocked indicator. However, you can certainly reverse the disassembly and reassembly sequence if you find it makes matters easier.

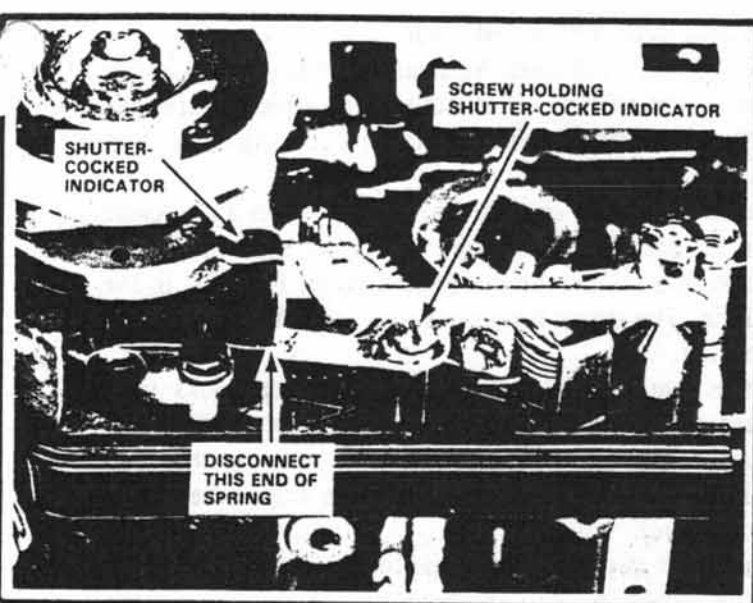

Figure 124

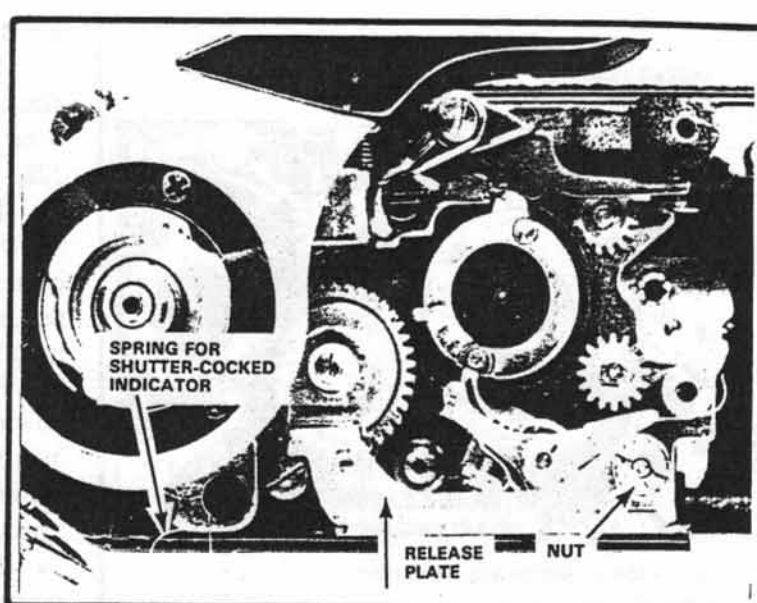

Figure 125

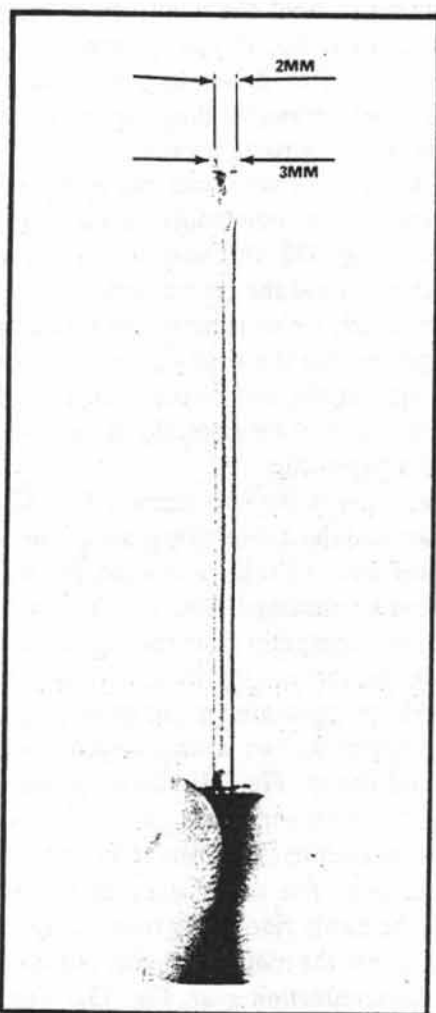

Figure 126

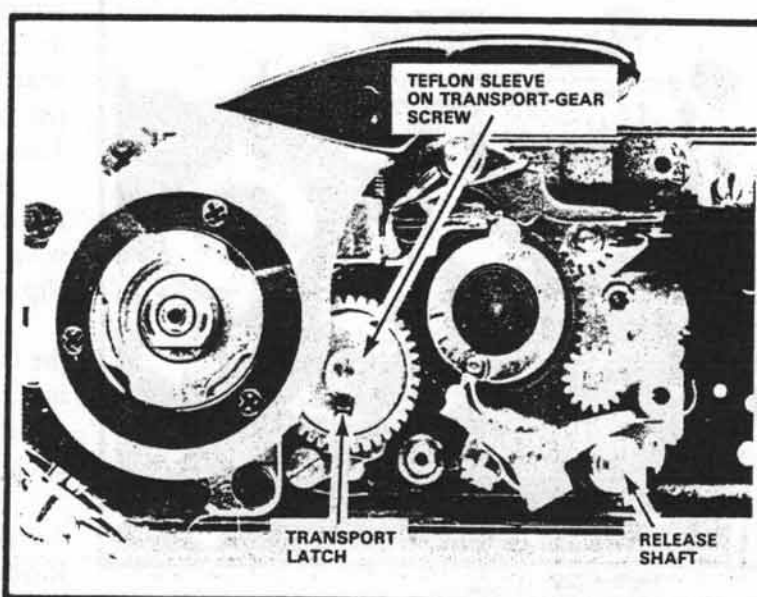

Figure 127

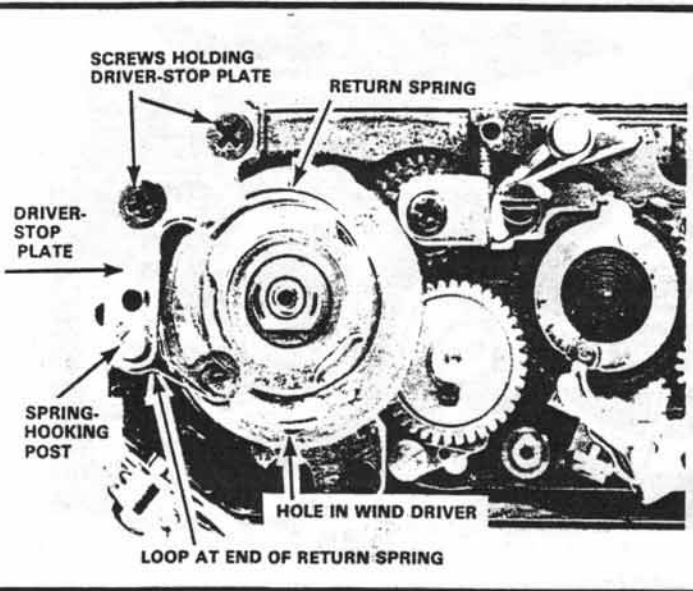

Figure 128

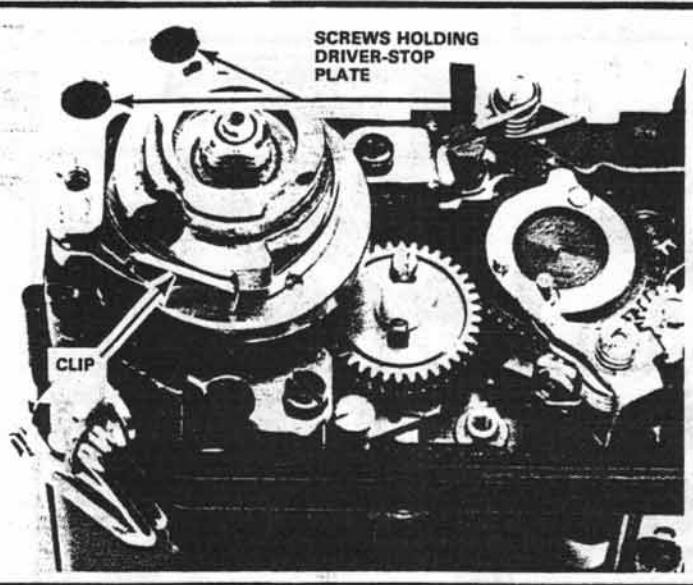

Figure 129

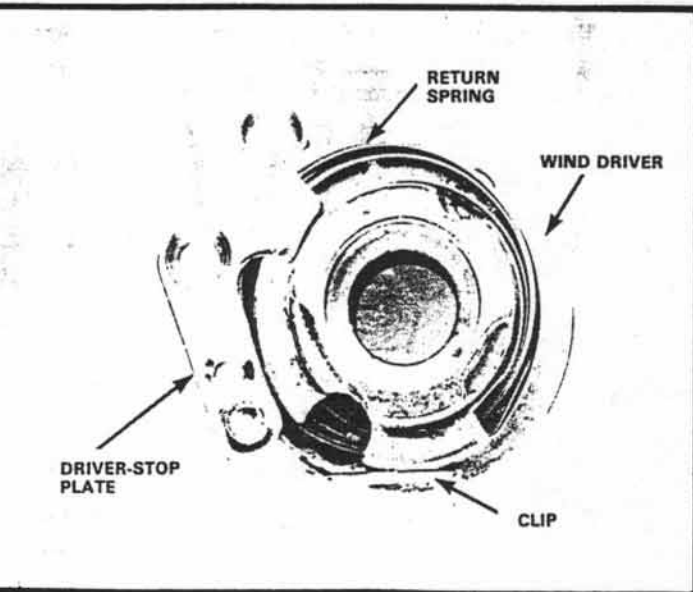

Figure 130

REMOVING THE WIND DRIVER

Take off the wind lever. You can then see the coils of the clocktype **return spring** -- that's the spring which returns the wind driver and the wind lever after the cocking cycle, Fig. 128.

The return spring rotates the wind driver in a clockwise direction (as seen from the top). A lug on the wind driver comes against a lug on the **driver-stop plate**, Fig. 128, in the rest position. The return spring now has around 3-1/2 turns of initial tension.

Notice that the end of the return spring hooks to a downward-projecting post on the driver-stop plate, Fig. 128. You must remove the driver-stop plate to take out the wind driver. But removing the driver-stop plate allows the return spring to unwind.

There's no problem in rewinding the return spring on reassembly. However, you can save time if you prevent the return spring from unwinding. There's enough tension on the return spring to hold the wind driver against the lug on the driver-stop plate. So, if you're careful, you can remove the wind driver and the driver-stop plate as one assembly. Just remove the two screws holding the driver-stop plate, Fig. 128. Then, lift out both parts together.

Or, to be extra safe, you can insert a clip to prevent the return spring from unwinding. Locate the small hole in the wind driver, Fig. 128; this hole allows you to insert a retaining clip which will hold the return spring.

In Fig. 129, we've inserted the retaining clip. One end of the clip passes into the wind-driver hole; the other end passes into the loop at the end of the return spring. Your retaining clip doesn't have to be especially strong -- you can even use a chunk of a paper clip.

Now, remove the two screws, Fig. 129, and lift out the wind driver and the driver-stop plate as one assembly, Fig. 130. If you ever have to replace a wind driver, the return spring comes already tensioned, Fig. 131. Notice that Pentax installs the spring-retaining clip from the underside of the wind driver. Just hook the spring loop to the driver-stop-plate lug. Then, remove the spring-retaining clip to replace the assembly.

Also notice the two spring-loaded pawls on the underside of the wind driver, Fig. 131. These pawls engage the ratchet teeth of the main-wind gear, Fig. 132. As the wind driver rotates in a counterclockwise direction, the pawls turn the main-wind gear. But as the wind driver returns to the ready position, the pawls ride freely over the ratchet teeth.

Notice that the main-wind gear engages the upper teeth of the two-piece **reduction gear**, Fig. 132. The lower teeth of the reduction gear engage the **lower transport gear**. Turning the main-wind gear then rotates the two-piece reduction gear. And the two-piece reduction gear turns the transport ("spill") gears to wind on the curtains.

There's no timing involved with the main-wind gear. So you can now lift the main-wind gear off the support shaft.

REASSEMBLY: Make sure you thoroughly clean the bearing surfaces of the support shaft, Fig. 132. Also clean the main-wind gear and the wind driver. Dirt on the bearing surfaces -- or a lack of lubrication -- results in a rough wind stroke.

Use a light-grease lubricant to lubricate the bearing surfaces of the support shaft. And lubricate the inside surfaces of the bearing holes in the main-wind gear and wind driver.

Now, seat the main-wind gear over the support shaft. Then seat the wind-driver/stop-plate assembly. As you're seating the wind-driver/stop-plate assembly, position the stop-plate holes slightly counterclockwise of the screw holes in the body casting, Fig. 133.

Once you've seated the assembly, rotate the wind driver in a clockwise direction until the screw holes align. And replace the two screws which hold the stop plate. You can now remove your spring-retaining clip and test the operation.

The procedure we've just described saves time because you don't have to rewind the return spring. But what if the return spring does come loose? You'll then have to reapply the initial tension.

Starting with the parts in the rest position, Fig. 128, wrap the return spring in a clockwise direction around the wind driver. You can determine when you have the proper amount of initial tension by pulling the end of the return spring (the end that connects to the driver-stop plate) toward the rewind end of the camera. Pull the return spring tight to see how far the end reaches.

With the proper amount of initial tension, the end of the return spring should reach to the middle of the camera body. What if the return spring reaches further than this? Then, you don't have enough initial tension. Continue to wind on the return spring, checking the initial tension after each turn. Now, connect the end of the return spring to the driver-stop plate.

The proper amount of initial tension is fairly critical. If you don't have enough initial tension, the spring coils will extend too far beyond the wind driver; that could cause a bind. Excessive initial tension results in a hard wind stroke.

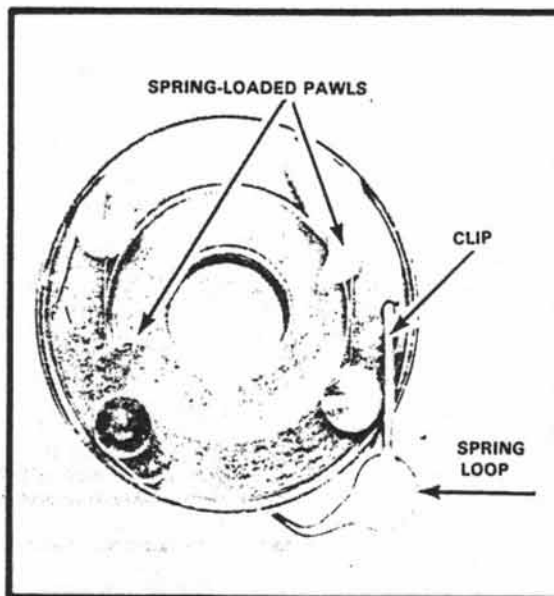

Figure 131 Bottom of wind driver

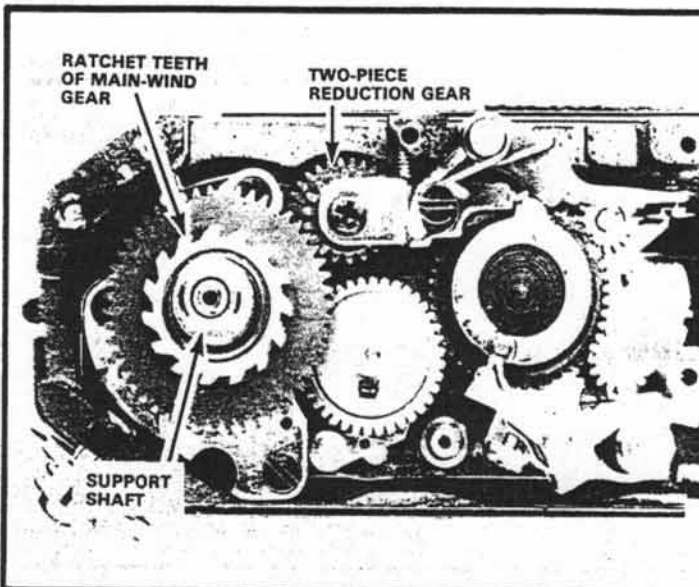

Figure 132

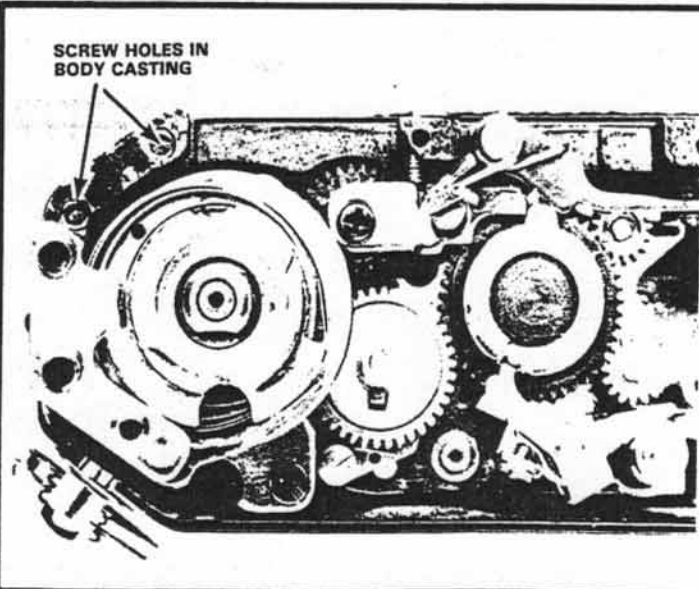

Figure 133 Starting position for replacing wind driver

REMOVING THE SUPPORT-SHAFT ASSEMBLY

The support-shaft assembly contains the spring-loaded counter shaft. Remember, the counter dial mounts to the upper end of the counter shaft, Fig. 134. A gear on the bottom of the counter shaft engages the mechanism which advances the counter dial.

You can see the counter-shaft gear by looking through the support-shaft clearance hole, Fig. 134. Notice that a pinion engages the teeth of the counter-shaft gear. The pinion advances the counter-shaft gear each time you cock the shutter.

While looking through the clearance hole, try opening the camera back. You can then see how the pinion moves away from the counter-shaft gear, Fig. 135. Disengaging the counter-shaft gear allows the spring-loaded counter shaft to return to its starting position.

You won't lose the initial tension of the counter-return spring when you remove the support-shaft assembly. Nor will you disturb any timing. But there is one danger -- removing the support-shaft assembly may free the counter-advance parts in the camera body.

The counter-advance parts are under spring tension. So there's a chance they'll go flying across the room when you remove the support-shaft assembly.

Keep the danger in mind as you remove the support-shaft assembly. Take out the three screws shown in Fig. 135 -- two countersunk screws and the spring-mounting screw which supports the shutter-cocked-indicator spring.

As a precaution, hold your hand over the wind-lever end of the camera body. And slowly slide out the support-shaft assembly. If the counter-advance parts do come out, they at least won't go too far.

Fig. 136 shows the counter-advance parts in the camera body. The **counter-dial ratchet pawl** has a torsion-type spring (this is the spring that may force the parts to jump out of place). Notice in Fig. 136 that the spring pushes the counter-dial ratchet pawl into engagement with a pinion. This pinion, the **counter-advance pinion**, is on the **counter-advance gear**; it's the pinion you observed earlier while looking through the clearance hole.

Since the counter-advance parts may not want to stay in place, it's a little difficult to simulate the operation. So you might simply visualize the counter action as we describe it. Remember, the pinion on the counter-advance gear, Fig. 136, engages the counter-shaft gear (remaining with the support-shaft assembly, Fig. 137).

Cocking the shutter rotates the **wind-shaft gear**, Fig. 136, in a clockwise direction. The **counter-dial actuator** on the wind-shaft gear, Fig. 136, then comes against a tooth on the counter-advance gear, Fig. 138. As the wind-shaft gear completes its cocking rotation, the counter-dial actuator advances the counter-advance gear one tooth.

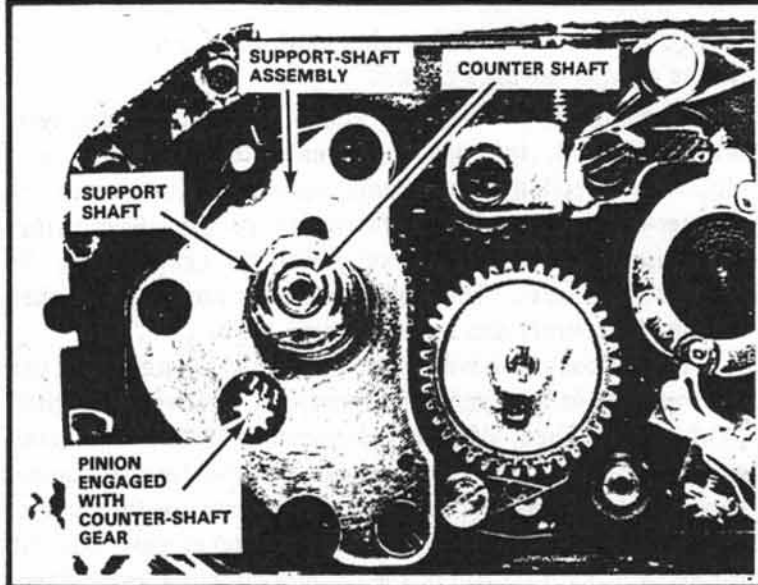

Figure 134

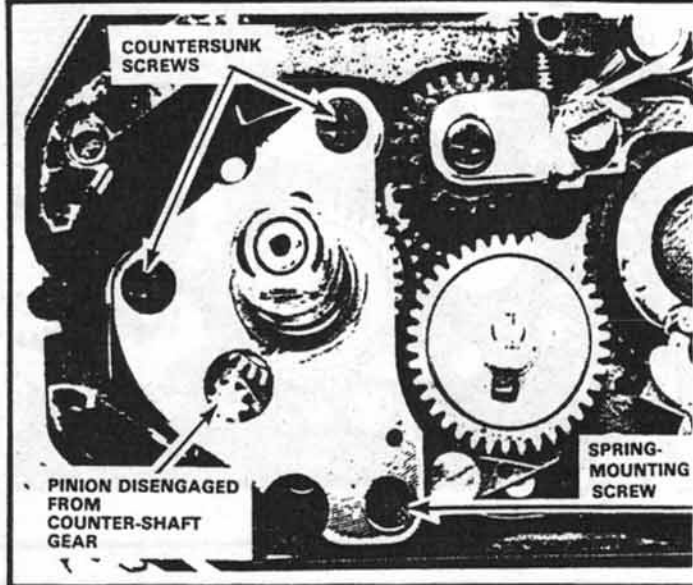

Figure 135

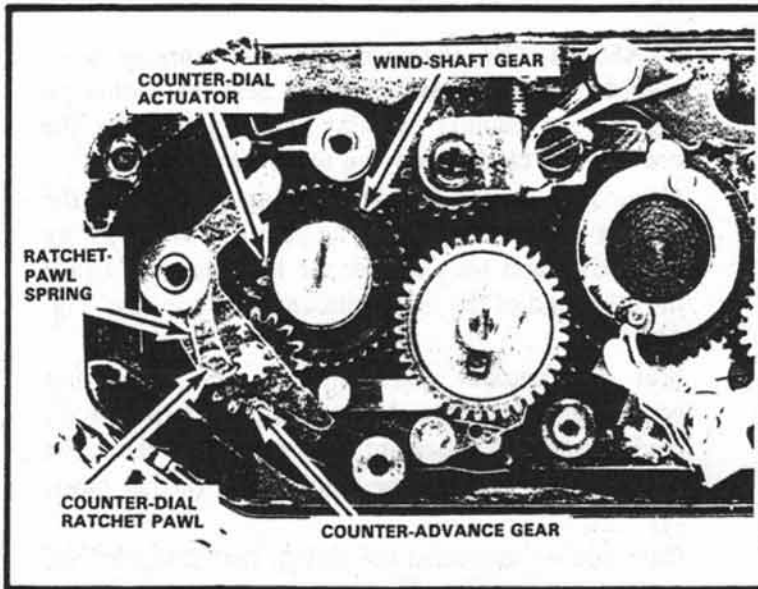

Figure 136

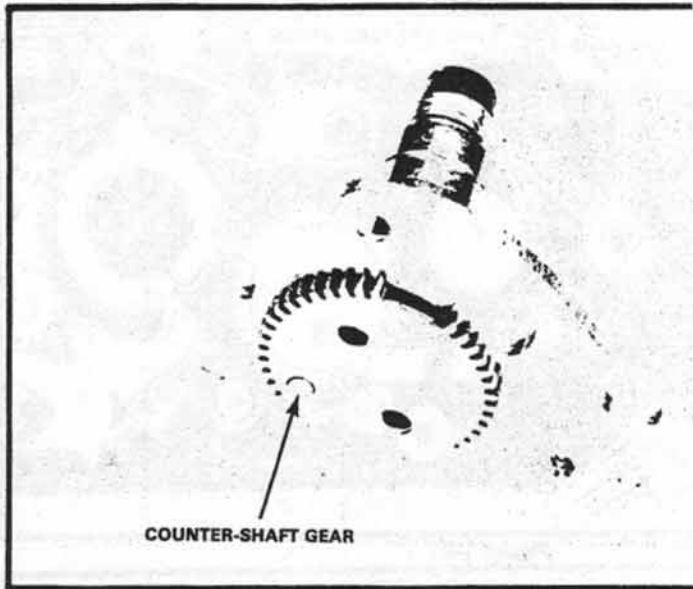

Figure 137 Bottom of support-shaft assembly 03239
03339

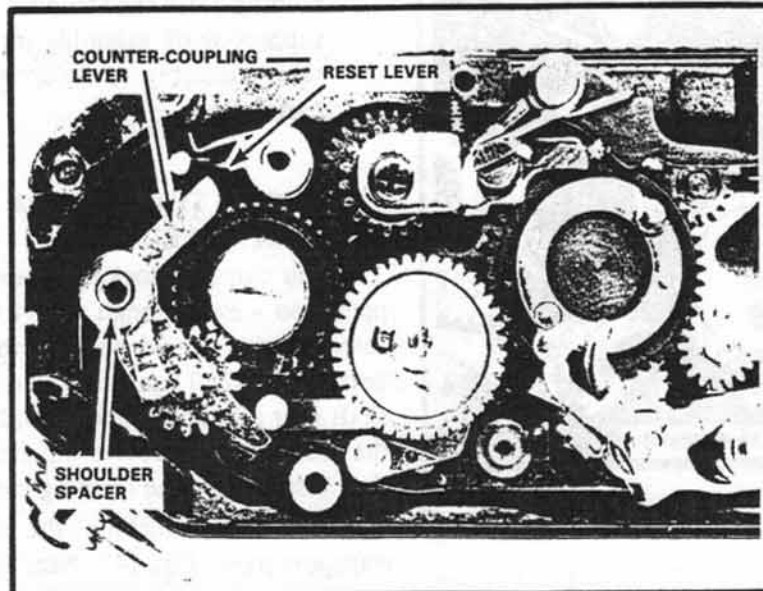

Figure 138

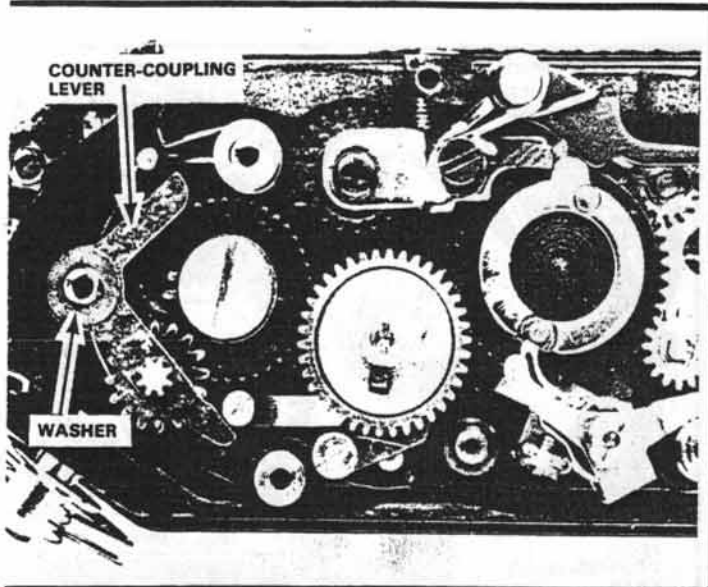

Figure 139

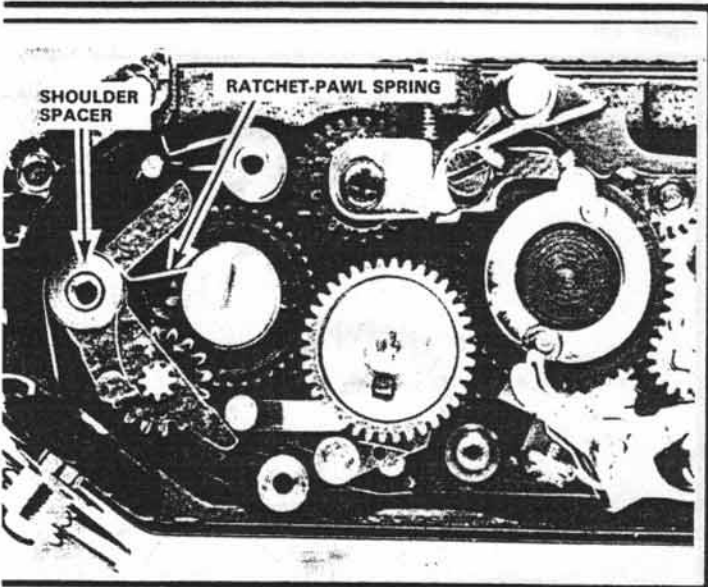

Figure 140

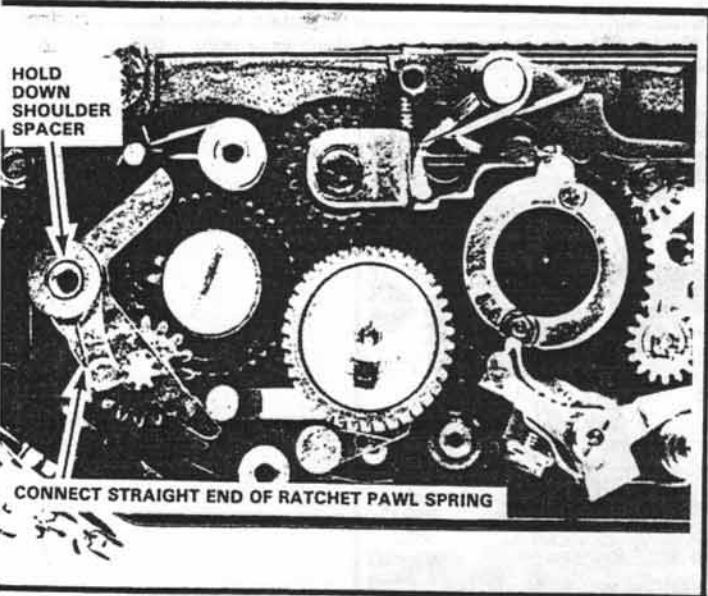

Figure 141

That one-tooth movement amounts to one film-frame calibration on the counter dial. To hold the parts at the new position, the counter-dial ratchet pawl drops into a tooth slot in the counter-advance pinion.

Opening the camera back allows the spring-loaded reset lever, Fig. 138, to push the counter-coupling lever in a clockwise direction. The counter-coupling lever carries the counter-advance gear. So, as the counter-coupling lever swings clockwise, the counter-advance pinion disengages from the counter-shaft gear. The spring-loaded counter shaft then returns the counter dial to the starting position.

If your counter-advance parts stayed in position, you can remove them at this time. Disconnect and remove the ratchet-pawl spring. Then, lift out the shoulder spacer. The small shoulder of the spacer fits through the counter-dial ratchet pawl; the large shoulder provides the retainer for the ratchet-pawl spring. Lift out the counter-dial ratchet pawl and the washer which sits on top of the counter-coupling lever. Then, lift out the counter-coupling lever.

REASSEMBLY: Place the counter-coupling lever over the shoulder post, Fig. 139. Seat the washer on top of the counter-coupling lever, and place the counter-dial ratchet pawl on top of the washer.

Now, seat the ratchet-pawl spring on top of the counter-dial ratchet pawl. The bent end of the spring goes down and rests against the body casting. Leave the other end of the spring disconnected for now, Fig. 140.

Seat the shoulder spacer through the spring and counter-dial ratchet pawl. Now, hold down the spacer. And connect the straight end of the ratchet-pawl spring to the post on the counter-dial ratchet pawl, Fig. 141.

Once you've connected the spring, the parts may not want to stay in place. So you may have to continue holding down the shoulder spacer. Then, "sneak" the support-shaft assembly into place. Use the support-shaft assembly to hold down the counter-operating parts.

OPERATING THE SHUTTER WITH THE WIND-LEVER PARTS REMOVED

You can still cock and release the shutter to check the operation -- even though you've removed the wind-lever parts. Insert a large screwdriver into the screw above the wind-shaft gear, Fig. 142. Then, using the screwdriver, rotate the wind-shaft gear a full turn clockwise; that cocks the shutter. Release the shutter by first depressing the transport latch, Fig. 143, and then disengaging the opening-curtain latch.

Try slowly cocking the shutter while watching the transport pawl, Fig. 143. Near the end of the wind cycle, the

transport-pawl swings toward the transport gears. The transport pawl drops into a notch at the bottom of the lower transport gear.

The transport pawl takes up any backlash in the mechanism. So, when you allow the wind lever to return, the transport gears won't back up (turn in a clockwise direction) too far.

ADJUSTING THE COUNTER-ADVANCE ACTION

Unlike many cameras, the Pentax has no forming or eccentric adjustment for the counter-advance action. What do you do, then, if the counter dial advances too far -- perhaps two film-frame calibrations rather than one? Or perhaps the counter dial doesn't advance far enough to latch at the next film-frame calibration?

You then have to replace the counter-dial ratchet pawl, Fig. 136. Pentax supplies three variations of the part. One type (part #0-3419) has an identification notch in the side. The second type (part #0-3219) has an identification hole. And the third type (part #0-03319) has no identification markings.

If you're doing a lot of Spotmatic repairs, you may wish to stock one of each type. You can then check and adjust the action at the stage of disassembly shown in Fig. 136. Use a 1.7mm screw to hold the counter-dial ratchet pawl in place. Now, rotate the main wind-shaft gear in a clockwise direction to cock the shutter. The counter-advance pinion should rotate until the counter-dial ratchet pawl drops into the next tooth slot.

Cock and release the shutter at least ten times to check the operation. That way, you're testing every position of the counter-advance pinion. If the counter-advance pinion rotates more than one tooth before the counter-dial ratchet pawl drops into engagement -- or if the counter-advance pinion doesn't rotate quite far enough for the counter-dial ratchet pawl to drop into engagement -- you may have to replace the counter-dial ratchet pawl.

But replacing the counter-dial ratchet pawl can cause a problem -- it's possible that the counter-shaft gear, Fig. 137, won't engage properly when you replace the support-shaft assembly. Pentax also has an answer for this possible problem; they supply two different types of support-shaft assemblies. That's why we've indicated two different part numbers in Fig. 137.

REMOVING THE BRAKE LEVER

In Fig. 142 and Fig. 143, you can get a little better look at the brake lever. The brake spring pushes the brake lever toward the opening-curtain wind gear. Remember, the brake-adjustment screw limits how far the brake lever can move.

As the opening-curtain wind gear moves from the cocked position, Fig. 143, to the released position, Fig. 142, it pushes aside the brake lever -- against the pressure of the brake spring.

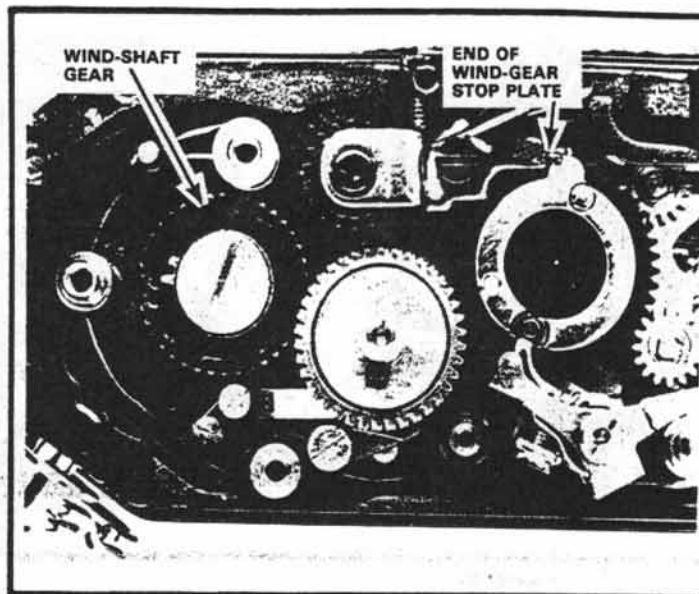

Figure 142

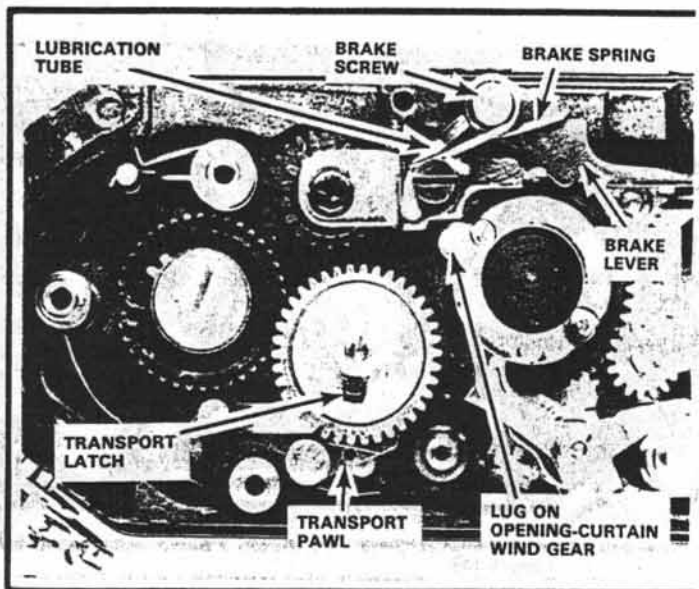

Figure 143

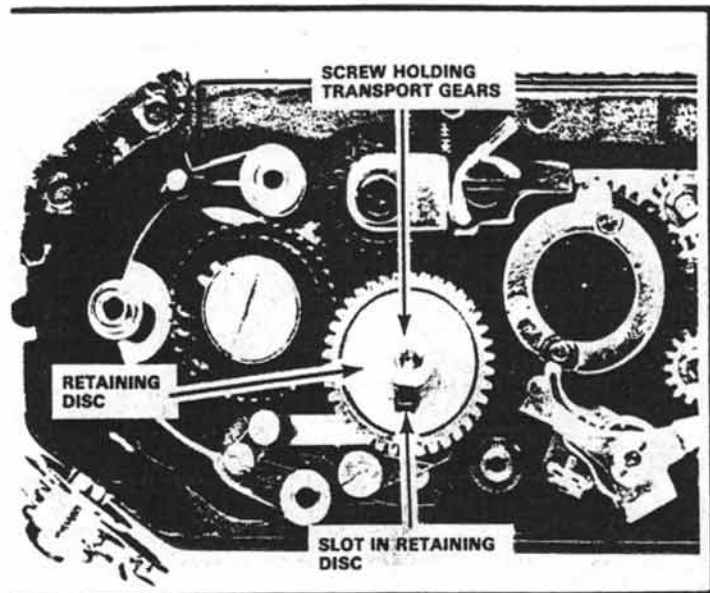

Figure 144

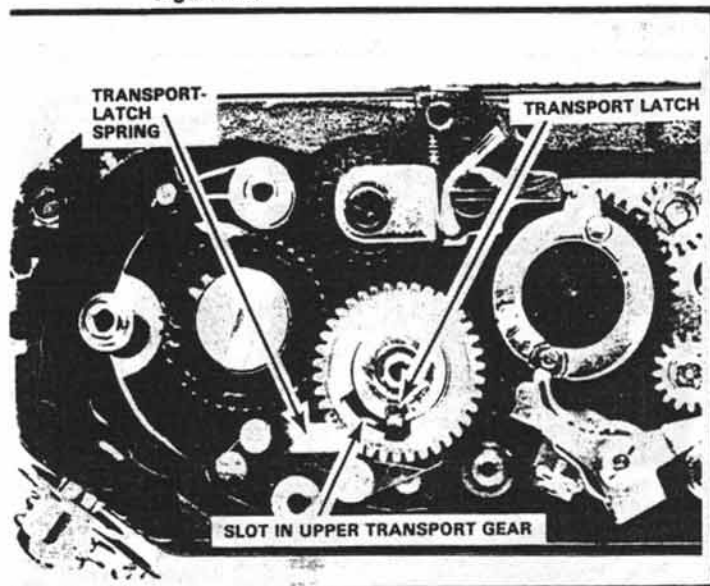

Figure 145

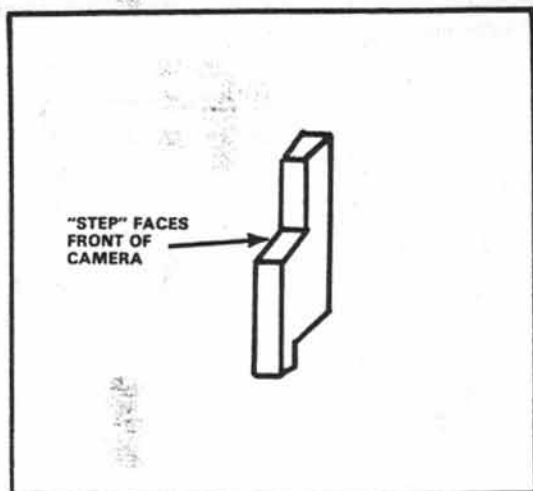

Figure 146 Transport latch

The brake spring then provides the cushioning action for the opening curtain.

Notice the **lubrication tube** in Fig. 143. Early Spotmatic models don't have this lubrication tube. Later models added the lubrication tube to supply oil to the side of the brake lever and to the lug on the opening-curtain wind gear, Fig. 143.

The lubrication tube contains a "string" of felt material within a plastic sleeve. As you can see in Fig. 142, only the material extends beyond the end of the wind-gear stop plate. The material then comes against the lug on the opening-curtain wind gear when the shutter is in the released position, Fig. 142. It comes against the side of the brake lever when the shutter is in the cocked position, Fig. 143.

You can lubricate the mechanism by placing a drop of shutter oil in the other end of the tube (the end which wraps around the long screwhead). The material within the tube stores the oil. It then feeds the oil, as needed, to the proper places.

To remove the brake lever, first disconnect the brake spring. One end of the brake spring hooks to a screw holding the wind-gear stop plate, Fig. 143; the other end hooks to the side of the brake lever. Disconnect the brake spring from the screwhead. Then, lift out the brake spring.

Remove the brake screw, Fig. 143, and lift out the brake lever. Watch for a loose washer under the brake lever; the washer sits between the brake lever and the body casting.

REMOVING THE TRANSPORT GEARS

For a routine shutter cleaning, you should remove the transport gears. Since the upper transport gear turns with the opening curtain, it must be very clean. Any dirt or lubrication in the upper transport gear will cause erratic curtain movement.

The timing of the transport gears is also critical. In a later topic, we'll go through the reassembly, timing, and test procedures. However, you may wish to skip ahead to the topic, "Replacing the Transport Gears," and perform the reassembly steps after removing the transport gears. This practice will be helpful -- you'll be timing the transport gears with nearly every shutter repair in a Spotmatic (or in earlier Pentax SLR's).

You can remove the transport gears with the shutter in the released position, Fig. 144 (as you'll later see, you must reassemble the transport gears with the shutter in the cocked position). Remove the screw (the one with the teflon sleeve) that holds the transport gears, Fig. 144.

Now, lift out the retaining disc, Fig. 144. Notice in Fig. 144 that the slot in the retaining disc faces the front of the camera. The slot provides clearance for the transport latch.

With the retaining disc removed, you can see how the transport latch couples the two transport gears together. Notice the step in the transport latch, Fig. 145; the step faces the front of the camera.

Right now, the step in the transport latch is level with the edge of the upper-transport-gear slot, Fig. 145. The lower end of the transport latch fits within a slot in the lower transport gear. So, as the lower transport gear rotates counterclockwise, it carries the transport latch in the same direction. And the side of the transport latch comes against the upper transport gear.

The transport latch then drives the upper transport gear in a counterclockwise direction. As you've seen, the upper transport gear turns the opening-curtain wind gear to advance the curtains.

But the curtains can't release until you disengage the upper transport gear from the lower transport gear. The lower transport gear can only rotate in one direction -- the direction that winds on the curtains. Yet the upper transport gear must be able to rotate in both directions.

As you'll recall, depressing the release shaft pushes down the transport latch. The step in the transport latch then moves below the upper transport gear. Now, there's nothing to prevent the upper transport gear from rotating freely in the release (clockwise) direction. So, when the mirror releases the opening-curtain latch, the upper transport gear spins with the opening-curtain wind gear.

Allowing the release shaft to move up also allows the transport latch to move up. The transport-latch spring, Fig. 145, pushes up the transport latch. The step in the transport latch then aligns with the upper transport gear, Fig. 145.

Now, lift out the transport latch. Note the shape of the transport latch in Fig. 146. On reassembly, you must insert the transport latch as shown in the drawing.

Also lift out the upper transport gear, Fig. 145. You can then see the slot in the lower transport gear that receives the transport latch, Fig. 147.

Finally, lift out the lower transport gear. On the underside of the lower transport gear, locate the notch that receives the transport pawl. The transport pawl remains in the camera, Fig. 148.

Notice that the support post for the lower transport gear has a teflon sleeve, Fig. 149. Because of the teflon sleeve, you don't need any lubrication on the lower transport gear. Normally, though, you should use a grease lubricant on a gear that turns with the wind mechanism.

How about the upper transport gear? It spins with the opening curtain. So you know that you don't want a grease lubricant here. A part that moves with the curtains normally takes an oil lubricant. However, it's generally better to leave the upper transport gear dry; don't use any lubricant at all.

Oiling the upper transport gear can cause problems. If dirt mixes with the oil, you'll get very erratic opening-curtain movement. Another danger is that the oil could work its way to the gear teeth; that would also cause erratic curtain movement.

In Fig. 149, you can also see the slot in the support bearing. The slot receives the transport latch. When you depress the release shaft, the transport latch moves down -- into the slot.

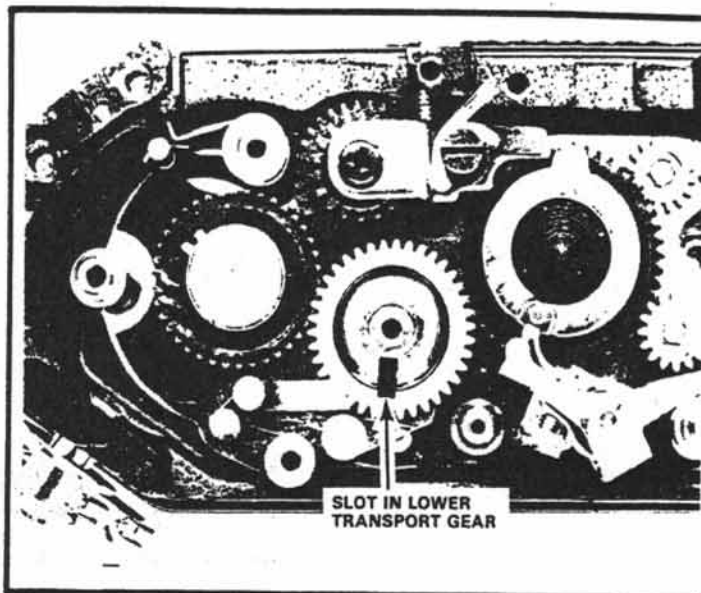

Figure 147

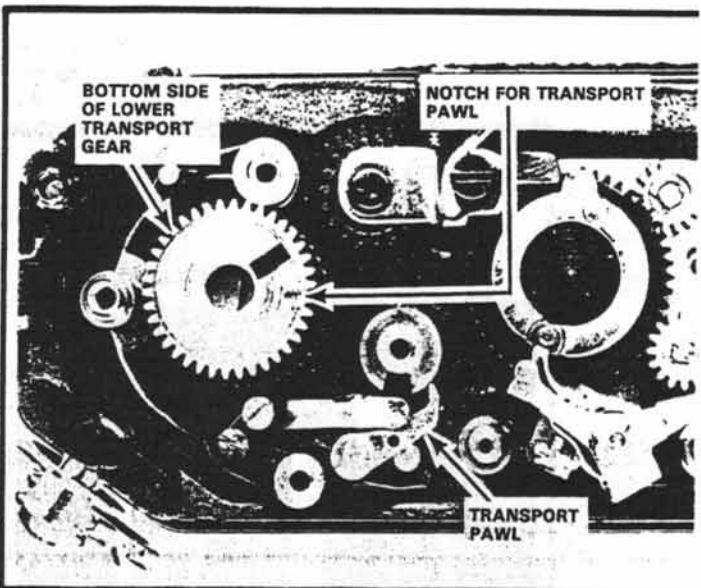

Figure 148

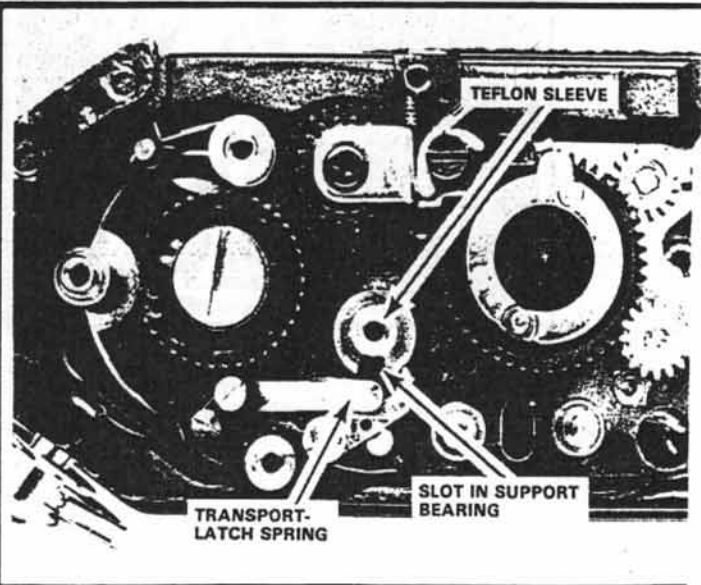

Figure 149

However, if the shutter isn't fully cocked, the transport latch doesn't align with the slot. As a result, you can't depress the release shaft -- the solid portion of the support bearing blocks the downward movement of the transport latch.

MINOR AND MAJOR OVERHAUL

For routine cleaning and lubrication, this may be as far as you'll have to disassemble the camera. You can now individually clean two of the most critical parts in the mechanism -- the transport gears. Also, you can individually clean and lubricate the other parts which you've removed. These parts include the speeds escapement, the wind-driver assembly, the main wind gear, and the mirror cage.

Going this far in the disassembly would be considered a "minor" overhaul. Here, you're not cleaning and lubricating the parts remaining in the camera body. Rather, you're just cleaning and lubricating the parts which you've removed.

A minor overhaul may be satisfactory in many situations. Consider that you've checked the curtain-travel times prior to disassembly. And you've found that the curtain-travel times are accurate. You then know that there's no problem in the curtain-wind gears or in the curtain rollers. Consequently, you won't have to clean and lubricate these parts.

If the bearings for the curtain rollers appear clean, however, you may wish to apply a drop of shutter oil to each bearing surface. What if the bearings are dirty? In that case, the additional oil won't do any good; oil won't stay on a dirty bearing. Dirty curtain bearings indicate the need for a "major" overhaul -- completely removing the curtain-wind gears and the curtains.

Some technicians do use a "flush-cleaning" technique. Flush-cleaning involves working the cleaning solution into the bearing surfaces, Fig. 150. You must then use compressed air to blow out the solution. Although you can do a satisfactory cleaning job at this stage of disassembly, you won't be able to reach all the lubrication points.

When lubricating a focal-plane shutter, you don't need step-by-step lubrication points if you keep this general rule in mind:

- Use shutter oil to lubricate parts which move during the release travel of the curtains.
- Use shutter grease to lubricate parts which do not move during the curtain-release cycle.
- Use shutter grease to lubricate latching parts.

When the curtains move in the release direction, they carry some parts with them. These parts must *not* have a grease lubrication; grease will cause erratic curtain movement. So, on parts such as the opening-curtain wind gear and the closing-curtain wind gear, you want shutter oil. Place a drop of oil between the gears and their bearing surfaces. But be careful that you don't get any oil on the gear teeth.

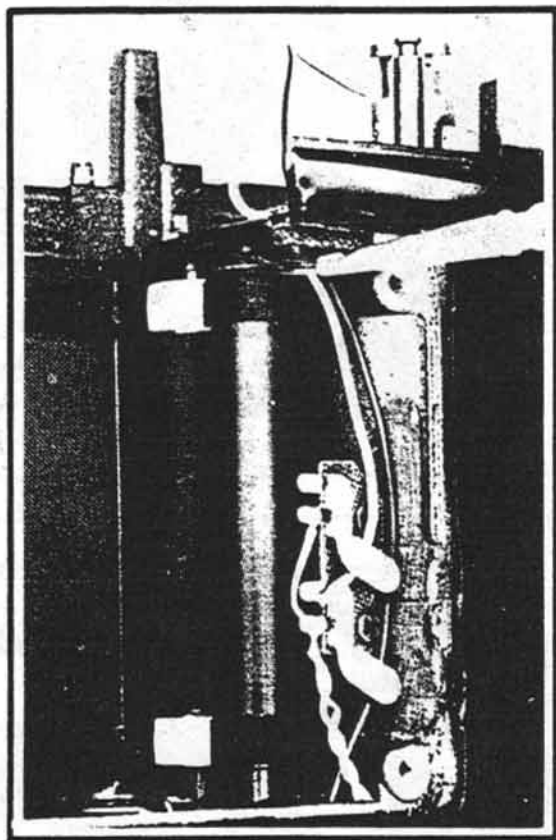

Figure 150
Using an artist-type brush to apply cleaning solution to the take-up-rollers' bearings.

Use an oil lubricant for the bearing surfaces of the curtain rollers. As mentioned earlier, the Pentax K1000 uses teflon bearings for the winding rollers. Place a tiny drop of oil at the points where the pinion shafts pass through these bearings. Also use shutter oil to lubricate the bearing surfaces between the take-up rollers and their central shafts.

The transport gears in Pentax cameras provide exceptions to our general rules. Although the upper transport gear spins with the opening curtain, you should leave the bearing surface dry. Oil on the large bearing surface could cause erratic curtain movement.

Use shutter grease to lubricate parts which turn during the wind cycle but don't turn during the release cycle. For example, lubricate the main wind gear with shutter grease. Place a little grease inside the hole and on the bottom surface of the main wind gear. Also, lightly lubricate the latching surfaces of the closing-curtain latch, the bulb lever, and the opening-curtain latch. Always make sure, though, that you've thoroughly cleaned the surfaces before applying any lubrication.

Unfortunately, there are some lubrication points you still can't reach. For example, you can't properly lubricate the closing-curtain wind gear without removing the opening-curtain wind gear. If the parts remaining in the camera body need cleaning and lubrication, you can perform the most satisfactory repair with a "major" overhaul -- completely disassemble the shutter.

Performing a major overhaul requires the same steps as does replacing the shutter curtains. In either case, wait until you've completely disassembled the camera before cleaning and lubricating the bearing surfaces. So, before covering any more reassembly steps, we'll describe the procedures for removing and replacing the curtains. You'll then be able to more clearly see the critical cleaning and lubrication points.

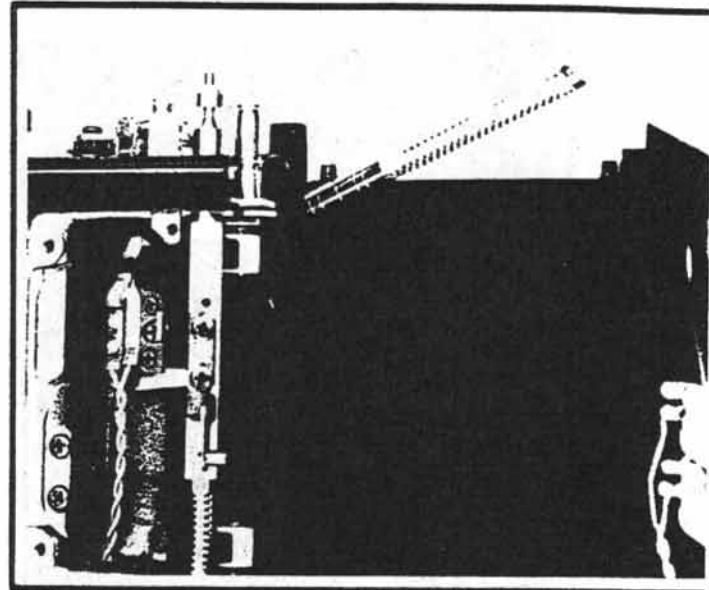

Figure 151 You can use a small jewelers' screwdriver to apply shutter oil. But don't apply oil to a dirty bearing.

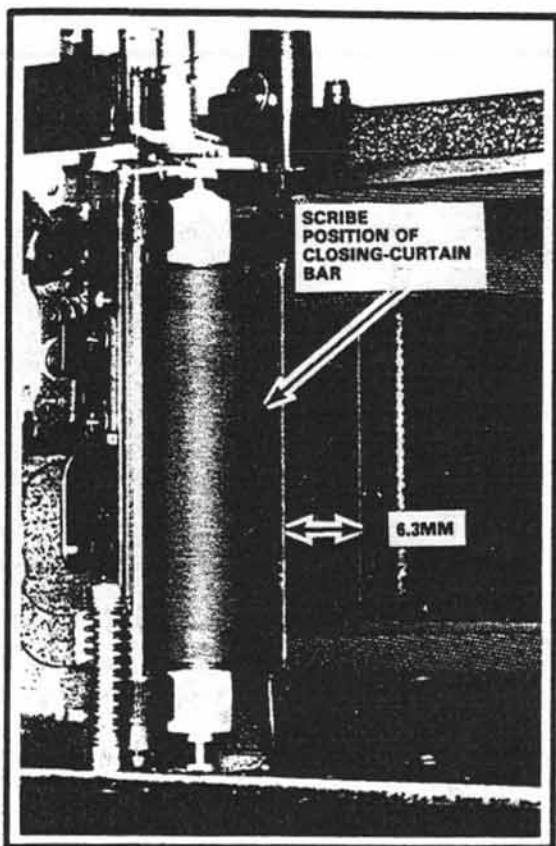

Figure 152
Shutter held open by closing-curtain latch.

CHECKING CURTAIN TIMING

When you know that you're going to disturb the curtain timing, there are two general rules you should always apply to focal-plane shutters:

1. Hold open the shutter on bulb. Then, place a scribe line inside the body casting to mark the position of the closing-curtain bar, Fig. 152. Your scribe line shows you proper timing for the closing-curtain wind gear. When the closing-curtain latch holds the closing-curtain wind gear, the lead edge of the closing curtain should be a certain distance away from the focal-plane aperture -- the distance marked by your scribe line. You can adjust this distance by changing the timing between the closing-curtain wind gear and the closing-curtain winding roller.
2. Note the curtain overlap during the cocking cycle. The amount of overlap tells you the proper timing for the opening-curtain wind gear. You can change the overlap by adjusting the timing between the opening-curtain wind gear and the opening-curtain winding roller.

On reassembly, first time the closing-curtain wind gear. Time the closing-curtain wind gear with the closing-curtain winding roller until the closing curtain comes to your scribe line, Fig. 152. Then, time the opening-curtain wind gear for the proper overlap during the cocking cycle.

The distance shown in Fig. 152 varies in different focal-plane shutters. In the Spotmatic, the proper distance is 6.3mm -- that's the distance between the lead edge of the focal-plane aperture and the lead edge of the closing curtain. By using the scribing technique, however, you don't need factory specifications.

You can see why the closing-curtain position is important if you'll recall how the camera operates at the slow-speed settings. Remember, the closing curtain creeps toward the focal-plane aperture while the speeds escapement engages the closing-curtain wind gear. But the closing-curtain wind gear pushes its way past the speeds escapement before the closing curtain actually enters the aperture.

Suppose, then, that you've set the distance shown in Fig. 152 to less than 6.3mm. That means the closing curtain sits too close to the focal-plane aperture when the closing-curtain latch is engaged. As a result, the closing curtain creeps into the aperture during the slow speeds.

With the speeds escapement installed, you can check the action from the back of the aperture. Open the camera back. Then, while looking at the back of the focal-plane aperture, operate the camera at a slow-speed setting. If you see the lead edge of the closing curtain start to enter the aperture while the

speeds escapement is engaged, you know that the closing-curtain timing is incorrect.

How about the opening-curtain timing? Here, you're timing the opening-curtain wind gear for the proper overlap during the cocking cycle. You generally want the same amount of overlap as you noted prior to disassembly. The curtains must overlap sufficiently to protect the film from light during the cocking cycle. But the overlap also affects the exposure on the release cycle -- especially the fast speeds.

The greater the overlap, the faster the speed you'll get. The overlap has a significant effect at 1/1000 second and at 1/500 second. However, the effect becomes less and less as you set slower speeds. It has no effect on the full-aperture speeds.

In the Pentax, the curtains should overlap one full bar during the cocking cycle -- that's typical of focal-plane shutters. Try looking at the front of the curtains as you cock the shutter. You should be able to see only one bar, the opening-curtain bar. The opening-curtain bar sits directly in front of the closing-curtain bar.

It's easier to understand the curtain timing of a double-roller focal-plane shutter after going through the procedure. So we'll cover the timing step-by-step during reassembly.

DISASSEMBLY TO REMOVE THE CURTAINS

Starting at the bottom of the camera, disconnect the spring from the mirror-catch lever, Fig. 153. Then, remove the E-ring, Fig. 153, and lift out the mirror-catch lever with its spring. The straight end of the spring hooks within a slot around the post shown in Fig. 153. This post also serves as one of the screws holding the winding-rollers support plate.

You'll also want to remove the mirror-return gear, Fig. 154. Notice that the mirror-return gear has a pin on its top surface (this is the pin which actuates the mirror-catch lever). The pin tells you that the gear's timing is critical. You could scribe the mirror-return gear. However, there's a convenient reference for reassembly:

With the shutter cocked, the pin on the mirror-return gear should point directly to the bearing hole for the pallet rod, Fig. 154.

Take out the screw, Fig. 154, and lift out the mirror-return gear. Notice that the mirror-return gear sits over a support post. What type of lubricant would you use on this bearing surface? Remember, the mirror-return gear spins as the closing curtain moves across the aperture. So, since the mirror-return gear rotates during the release cycle, you need shutter oil.

The winding-roller pinion, Fig. 154, drives the mirror-return gear. A screw holds the winding-roller pinion to the lower end of the closing-curtain winding-roller pinion shaft.

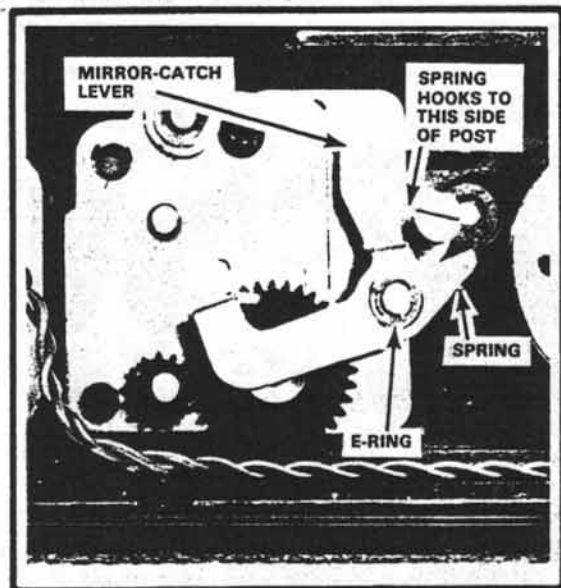

Figure 153

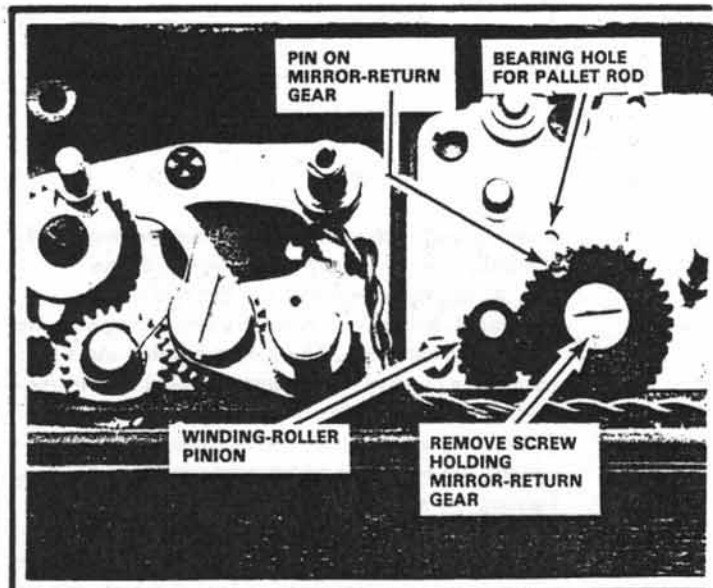

Figure 154

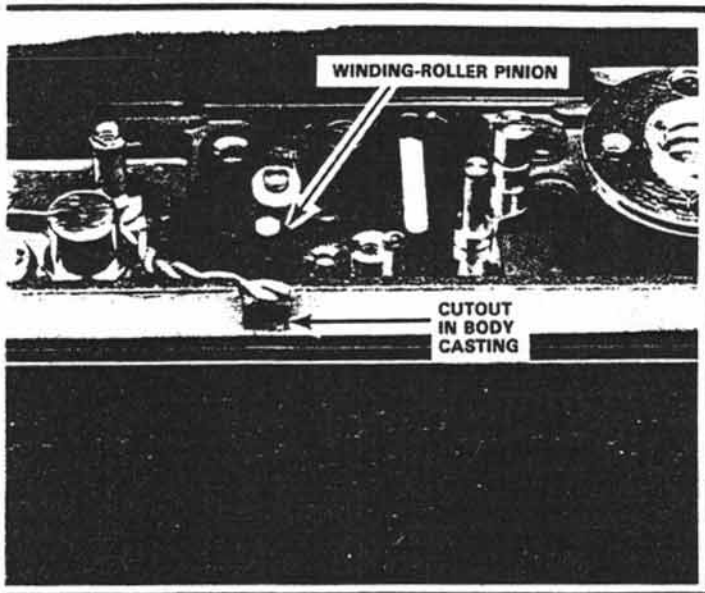

Figure 155 Shutter released

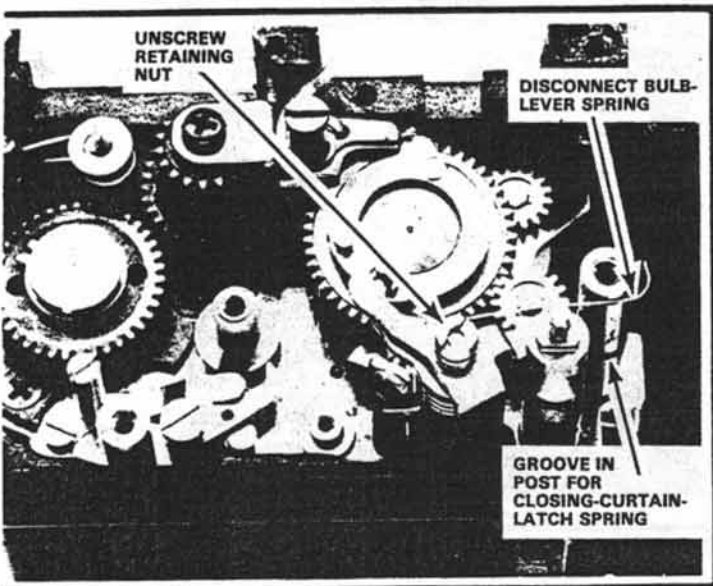

Figure 156

Remove and replace the closing-curtain latch and the bulb lever as an assembly, as shown on the left. At the right, you can see the two parts separated. Notice that there are two springs on the closing-curtain latch. The spring pointed out here moves the closing-curtain latch toward the closing-curtain wind gear. The heavier spring holds the cam-follower section of the closing-curtain latch against the setscrew which controls the slit width. Turning the slit-width setscrew moves the cam-follower end of the closing-curtain latch closer to or further from the release cam. Both springs hook to a notch in the latching section of the closing-curtain latch

Notice the cutout in the back of the body casting, Fig. 155. This cutout allows you to reach the screw.

Rotate the closing-curtain winding roller, winding on the closing curtain, until the screwdriver slot faces the back of the camera. Then, insert your screwdriver through the clearance slot, Fig. 155, and remove the screw. Now, lift off the winding-roller pinion.

Proceeding next to the top of the camera, disconnect the bulb-lever spring from the mechanism-plate post, Fig. 156. Then, unscrew and remove the retaining nut, also shown in Fig. 156. The bulb-lever spring stays with the nut.

The spring for the closing-curtain latch hooks to the lower groove in the mechanism-plate post. Hold the end of the spring away from the post as you lift out the closing-curtain latch and the bulb lever. The closing-curtain latch may separate from the bulb lever once you remove the parts, Fig. 157. But, for disassembly and reassembly, consider the two parts as one unit -- remove them together and replace them together.

It's not absolutely necessary to remove the release shaft, Fig. 158. However, you'll find that removing and replacing the curtains will be a lot easier with the release shaft out of your way.

To remove the release shaft, you must take off the extension arm, Fig. 158. Remember, the extension arm releases the mirror latch on the mirror cage. But the extension arm has a sliding adjustment; after loosening the two screws, Fig. 158, you can slide the extension arm up or down.

The adjustment controls the overtravel of the release shaft. After the mirror releases, you should be able to push down the release shaft a slight distance further -- that's the overtravel. For example, say you move the extension arm closer to the bottom of the camera. The mirror then releases sooner during the downward travel of the release shaft. As a result, the release shaft has more overtravel; it can continue moving down for a greater distance after the mirror releases.

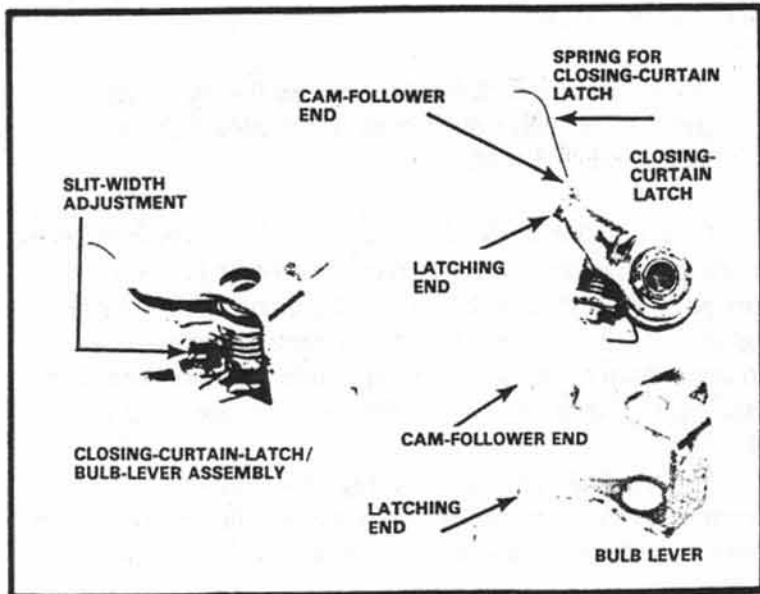

Figure 157

You can make the overtravel adjustment after replacing the mirror cage. Slowly push down the release shaft until the mirror releases. You should then be able to push down the release shaft an additional 0.2mm. Insufficient overtravel means it takes too much pressure on the release button to release the shutter. And if you have too much overtravel? The mirror then releases too soon, and the camera has a "hair trigger." A very light touch on the release button releases the shutter.

Take out the two screws and lift off the extension arm. Then, remove the E-ring and the washer at the bottom of the release shaft, Fig. 159. Watch for two loose parts as you lift out the release shaft toward the top of the camera -- the compression spring and the brass shoulder spacer, Fig. 158, will be loose.

REASSEMBLY: Start the release shaft into its mechanism-plate hole from the top of the camera. Then, before seating the lower end of the release shaft, slip the compression spring onto the release shaft, Fig. 158. Replace the shoulder spacer with its smaller diameter passing into the camera-body hole. Finally, seat the lower end of the release shaft and replace the washer and E-ring, Fig. 159.

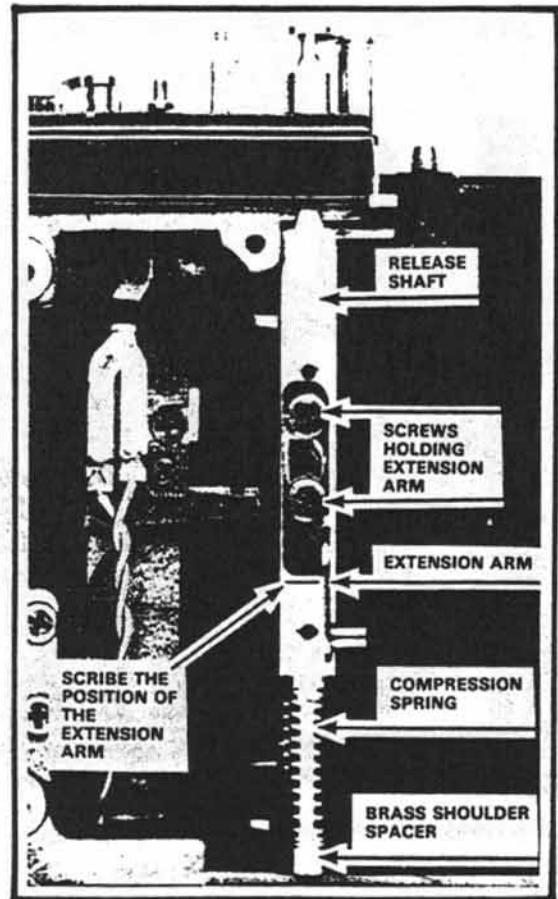

Figure 158

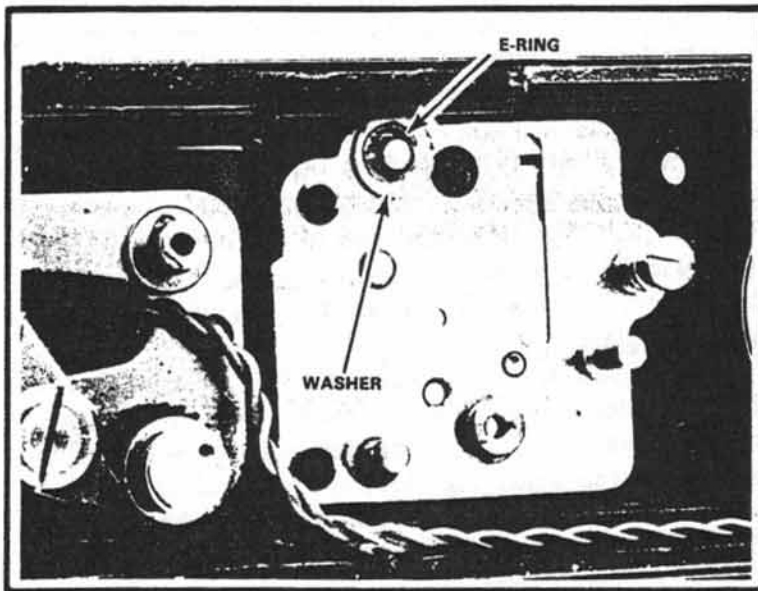

Figure 159

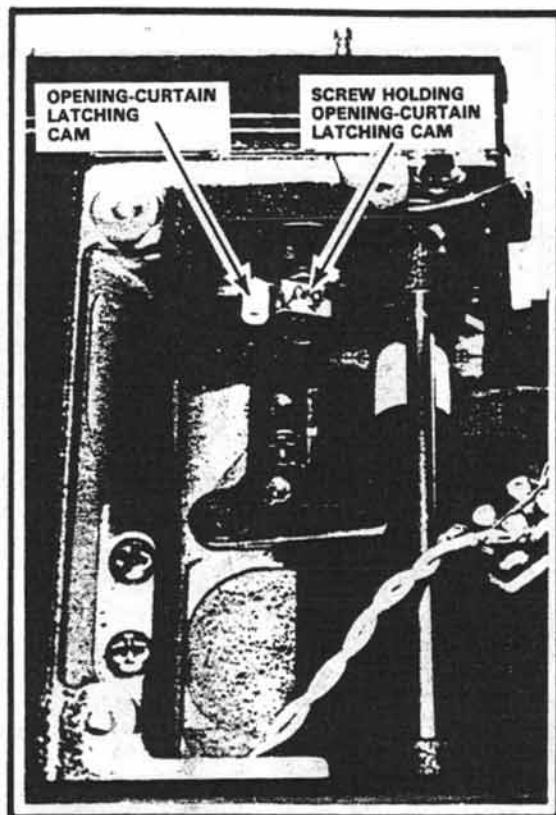

Figure 160

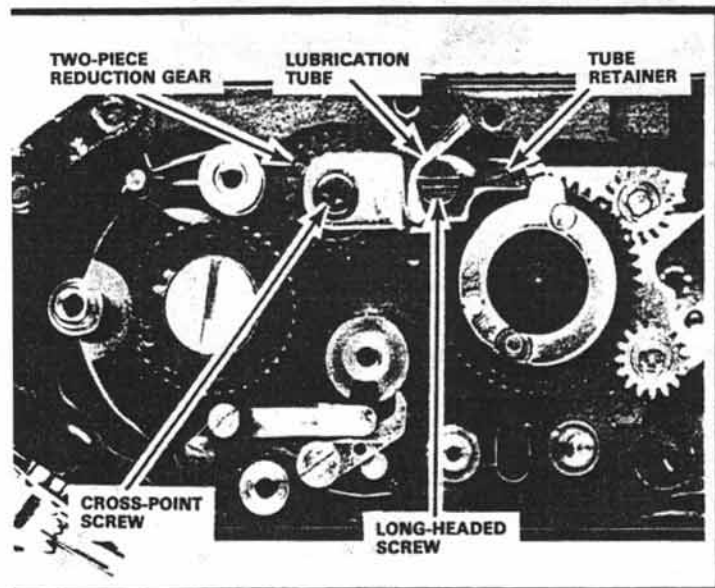

Figure 161

Now, remove the two screws holding the X-sync contacts. Lift aside the X-sync contacts as shown in Fig. 160; you don't have to unsolder the wires.

A screw holds the opening-curtain latching cam to the shaft of the opening-curtain wind gear, Fig. 160. Notice that red lacquer locks the screw. In this case, the red lacquer doesn't secure an adjustment; it just prevents the screw from working loose.

You must remove the screw, Fig. 160, to take out the curtain-wind gears. However, it's also necessary to remove the wind-gear stop plate. So, before taking out the screw holding the opening-curtain latching cam, we'll go through the procedure for removing the wind-gear stop plate, Fig. 161.

Before removing the wind-gear stop plate, you should let off the curtain tensions. Otherwise, the curtains may pull the winding rollers too far in the release direction; that could pull loose the cemented curtains.

Loosen the setscrews which lock the tension-setting worms, Fig. 162. These setscrews should be sealed with red lacquer. Next, use a screwdriver to turn the tension-setting worms in a counterclockwise direction. That lets off the initial tensions.

In an unfamiliar camera, it helps to count the turns of initial tension on each curtain. You then have a starting point for setting up your curtain-travel times. In the Spotmatic, you should have two full turns on the closing-curtain take-up roller and 1-1/2 turns on the opening-curtain take-up roller.

How do you know when you've let off all the tensions? Try using your thumb to rotate the take-up rollers in a counterclockwise direction; you can then feel the spring tension on each roller. When you can no longer feel any spring action, you know that you've let off all the initial tension.

It's now safe to disassemble the wind-gear stop plate. Notice how the lubrication tube passes through a hole in the tube retainer, Fig. 161. This end of the tube sits within a groove in the top of the wind-gear stop plate. The other end of the tube tucks around the long-headed screw holding the wind-gear stop plate.

When you remove the wind-gear stop plate, you'll have quite a few loose parts -- the lubrication tube, the tube retainer, and some washers. Take out the cross-point screw holding the wind-gear stop plate, Fig. 161; there should be a locking washer under this screw. Then, remove the long-headed screw, Fig. 161 (the long head also serves to hook the brake spring). Lift out the lock washer, the flat washer, and the tube retainer.

The lubrication tube normally remains with the tube retainer. However, it may come loose. We'll describe the procedure for positioning the lubrication tube during reassembly.

Now, lift out the wind-gear stop plate. Also lift out the two-piece reduction gear, Fig. 161. As yet, you haven't disturbed any timing. However, you will be disturbing critical timing when you remove the curtain-wind gears. Although we briefly described the timing earlier, we'll go through the pro-

cedure step-by-step on reassembly. The timing procedures apply to most double-roller focal-plane shutters.

Take out the screw holding the opening-curtain latching cam, Fig. 160. Then, lift out the opening-curtain wind gear. Careful -- the opening-curtain latching cam, Fig. 160, will come off the opening-curtain wind-gear shaft.

You can now see the closing-curtain wind gear, Fig. 163. The **latching lug** on the top of the closing-curtain gear couples to a pin on the bottom of the opening-curtain wind gear. So, as the opening-curtain wind gear rotates to the cocked position, it carries the closing-curtain wind gear in the same direction.

When you release the shutter, the closing-curtain latch engages the latching lug, Fig. 163; that's how the closing-curtain latch holds back the closing curtain. The release cam (which you've already removed) disengages the closing-curtain latch according to the distance that the opening curtain has traveled.

How about the lower lug on the closing-curtain wind gear? It's the **retard-drive lug**, Fig. 163. The retard-drive lug pushes aside the upper retard-rod lever at the slow speeds. The pin on the closing-curtain wind gear, Fig. 163, serves to disengage the pallet after the exposure. Once the closing curtain has crossed the aperture, the pin strikes the upper pallet-rod lever. The closing-curtain wind gear then drives the pallet out of engagement with the star wheel.

You can now lift out the closing-curtain wind gear. During reassembly, we'll point out the lubrication points. But, before applying any lubrication, make sure you thoroughly clean the bearing surfaces. Clean both of the curtain-wind gears. Also clean the bearing surfaces for the curtain-wind gears -- the outside surface, Fig. 164, for the closing-curtain wind gear and the inside surface for the opening-curtain wind gear.

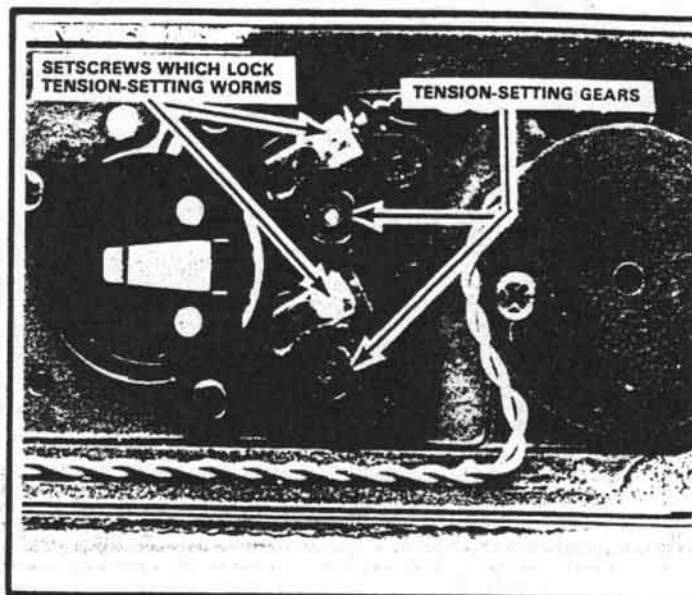

Figure 162
The tension-setting worms will be loose once you let off the initial tensions.



Figure 163

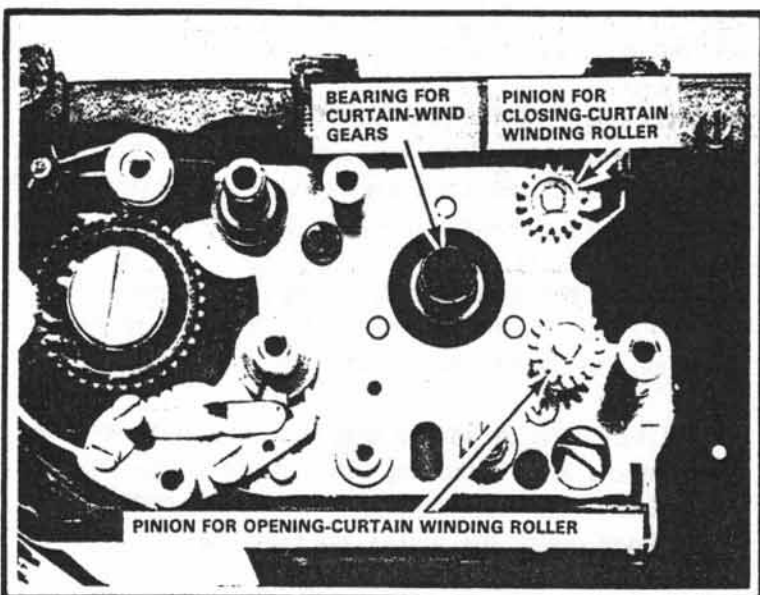

Figure 164

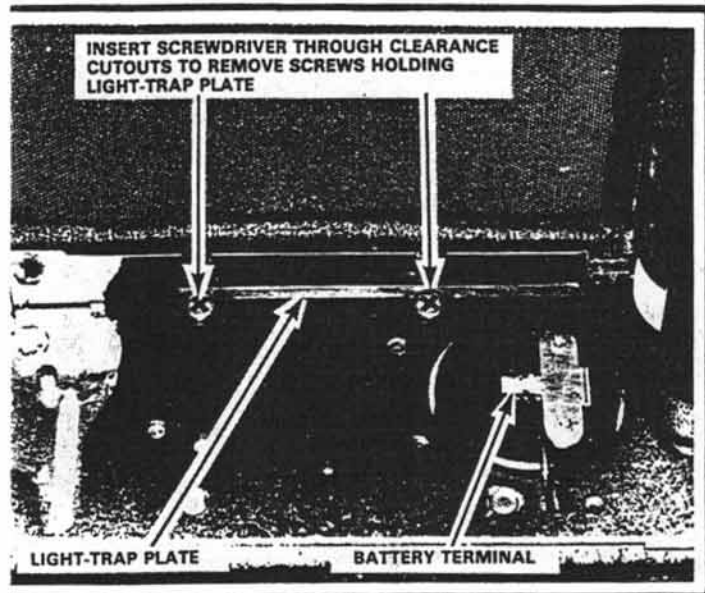

Figure 165

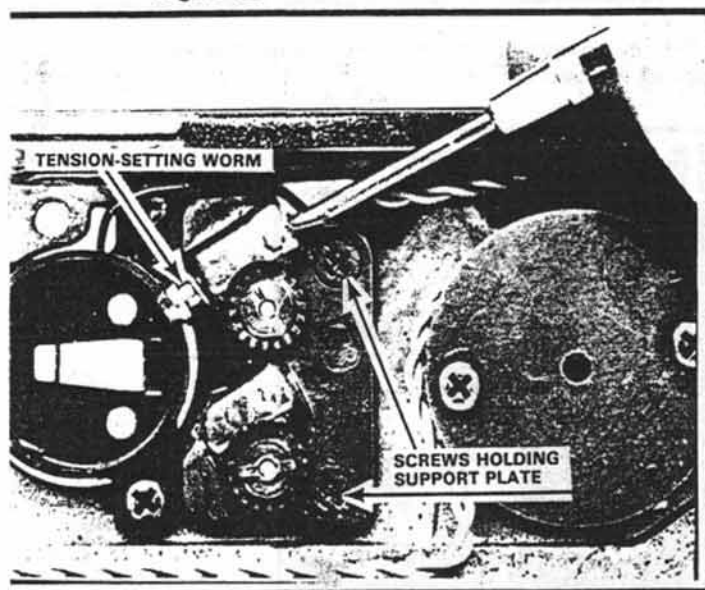

Figure 166 Removing the closing-curtain tension-setting worm

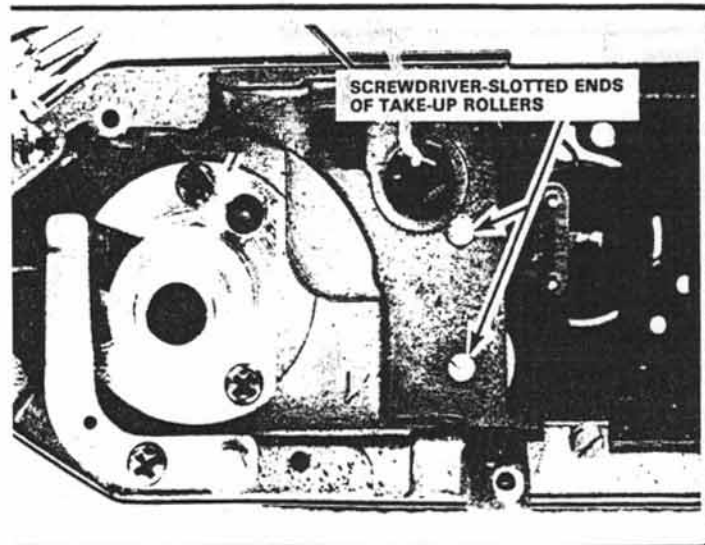

Figure 167

There's one more part to get out of the way before you remove the curtains -- the **light-trap plate** at the bottom of the body casting, Fig. 165. Remove the two screws, Fig. 165, and lift out the light-trap plate.

REMOVING THE TAKE-UP ROLLERS

At this point, there should be no initial tension on the take-up rollers, Fig. 166. Now, push the tension-setting worms out of their body-casting housings (from right to left as seen in Fig. 166). Both of the tension-setting worms are identical. So, on reassembly, it doesn't matter which tension-setting worm you use for which curtain.

Both of the tension-setting gears screw onto the ends of the take-up rollers' central shafts. Also, *both tension-setting gears have left-hand threads*. However, there's a trick to unscrewing the tension-setting gears -- you must hold the central shafts to keep them from turning.

At the top of the camera, locate the upper ends of the central shafts, Fig. 167. Each central shaft has a screwdriver slot. Use a screwdriver to hold each central shaft stationary. Then, use your Multispan wrench, a large screwdriver, or the special tool described earlier (Fig. 126) to unscrew each tension-setting gear in a clockwise direction, Fig. 166.

Now, remove the two screws shown in Fig. 166 and lift out the take-up-rollers support plate. Slide the closing-curtain take-up roller toward the bottom of the camera as you lift it from the camera -- that way, you can disengage the upper end of the central shaft from the upper bearing hole.

CAUTION: Watch for the loose endplay washer on the upper end of the closing-curtain take-up roller.

Use the same technique to remove the opening-curtain take-up roller. But you now have two loose parts to watch for -- the teflon guide roller and the endplay washer, Fig. 168. Remove the two endplay washers (one for each take-up roller) and the teflon guide roller to prevent accidental loss.

REMOVING THE WINDING ROLLERS

Three screws hold the winding-rollers support plate, Fig. 169. Notice that each screw is different -- one is a countersunk screw, one is a shoulder screw, and one doubles as a spring-hooking post.

Remove the three screws, noting their proper positions. Then, lift up the winding-rollers support plate to clear the lower ends of the winding rollers.

CAUTION: Be careful that you don't turn over the camera after removing the winding-rollers support plate -- there are loose spacers on the ends of the pinion shafts, Fig. 170. There may also be loose end-play washers.

Pentax uses the endplay washers to individually adjust the endplay of the winding rollers. So the positions of the washers aren't always the same in different cameras. As you remove the endplay washers, be very careful to note their positions.

Lift the spacer from the opening-curtain pinion shaft, Fig. 170; again, watch for endplay washers which may or may not be present in your camera. Then, lift the spacer from the closing-curtain pinion shaft. Notice that the spacer for the opening-curtain pinion shaft is longer than is the spacer for the closing-curtain pinion shaft.

There's one more loose part -- the teflon guide roller over the closing-curtain pinion shaft, Fig. 171. Lift out the teflon guide roller. You can't as yet lift out the upper guide roller or the winding rollers; that takes a little more disassembly.

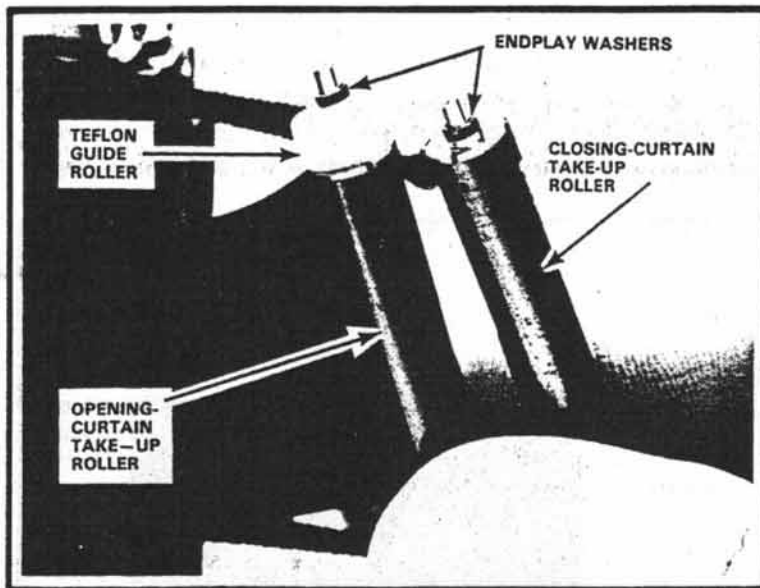

Figure 168

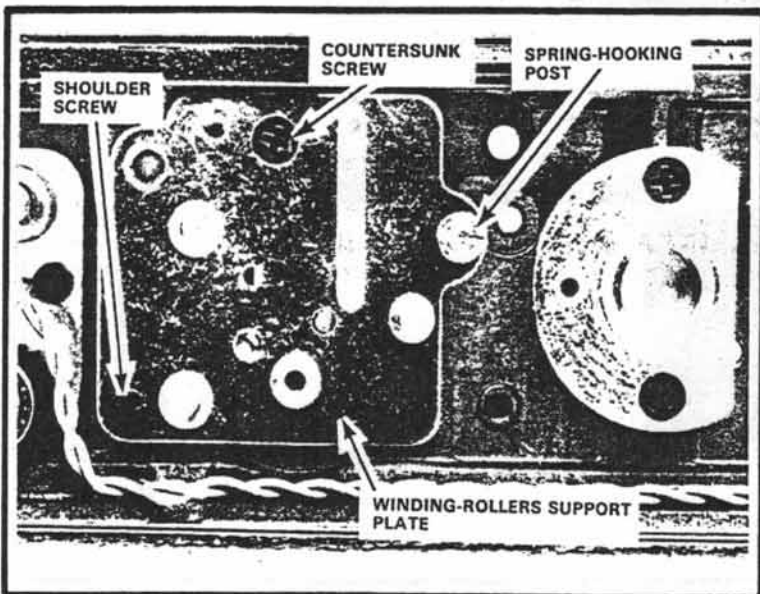

Figure 169

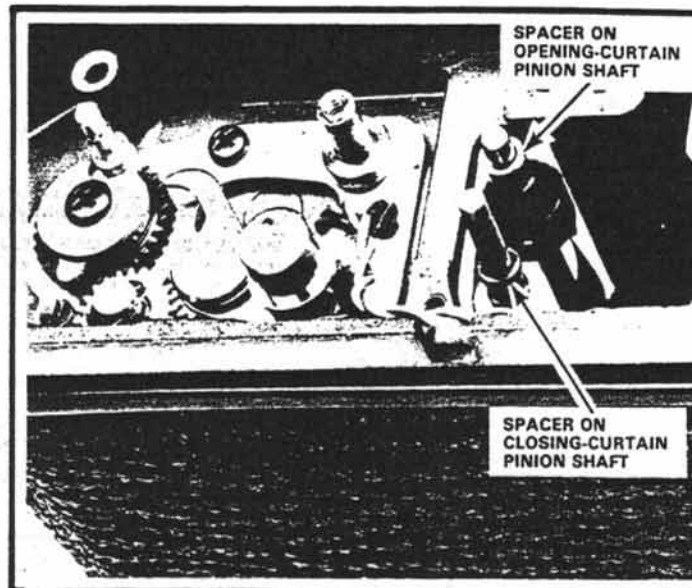

Figure 170

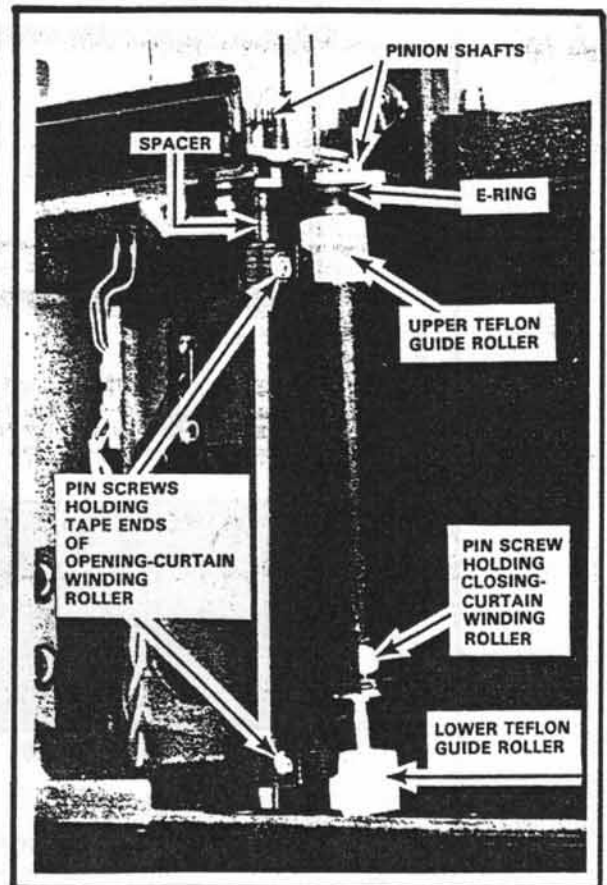

Figure 171

To remove the winding rollers, you must take out the pinion shafts. Two pin screws, Fig. 171, hold the opening-curtain pinion shaft; one pin screw passes through each of the two tape ends of the opening-curtain winding roller, Fig. 171.

Remove the two pin screws shown in Fig. 171. Notice the spacer above the upper tape end, Fig. 171 -- this spacer will be loose once you remove the pinion shaft. Slide out the pinion shaft toward the top of the camera, allowing the two tape ends and the spacer to slip off the bottom of the shaft.

Next, remove the single pin screw at the bottom of the closing-curtain winding roller, Fig. 171. However, you'll find that you still can't pull out the closing-curtain pinion shaft -- an E-ring clips to a groove in the top of the pinion shaft, Fig. 171.

Take out the E-ring shown in Fig. 171. Careful -- there's another spacer right above the E-ring. Now, pull out the closing-curtain pinion shaft toward the top of the camera. The spacer and the upper teflon guide roller, Fig. 171, will both be loose.

You can then remove both curtain assemblies from the camera. Fig. 172 shows the separate curtains with their associated parts. Notice the difference between the two sets of teflon guide rollers -- the guide rollers which go at the winding-

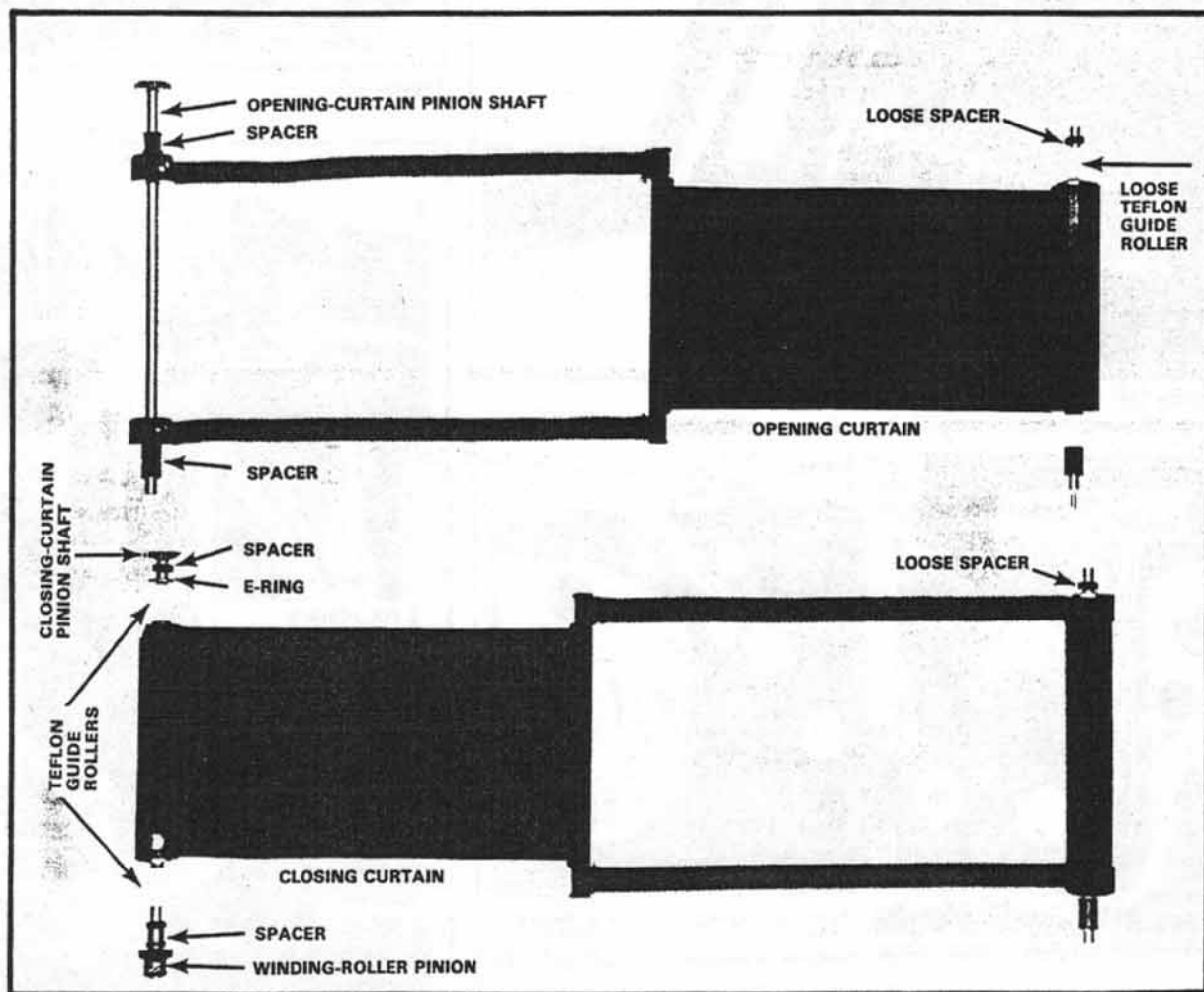

Figure 172

rollers side of the camera are smaller in diameter than are the guide rollers which go at the take-up-rollers side. For reassembly reference, it helps to keep the loose parts with their particular curtains.

With Pentax cameras, you normally don't have to cement curtains or tapes to the rollers (unless one pulls loose). That's because replacement curtains come already attached -- both to the winding rollers and to the take-up rollers. When you order replacement curtains, you also get new take-up rollers and new winding rollers. So, as you go through the curtain-installation procedure, you'll be taking the same steps as you would to install new curtains.

LUBRICATION: Now's the easiest time to clean and lubricate the take-up rollers. Remember, the critical points are the bearing surfaces between the take-up rollers and the central shafts. During the release cycle, the central shafts don't move. But the take-up rollers must spin around the central shafts as the curtains cross the aperture.

To clean the take-up rollers, first push up one of the central shafts. You can then clean the section of the central shaft extending above the take-up roller. Push down the central shaft to clean the lower end. Clean the central shaft for the other take-up roller in the same manner. As you can see, it's much easier to clean the take-up rollers after removing the curtains from the camera.

Now, use shutter oil to lubricate the take-up rollers. Place just a touch of oil between the bearing surfaces and the central shafts.

REPLACING THE SHUTTER CURTAINS

Start your curtain reassembly with the opening-curtain winding roller, Fig. 173 (even though you removed the closing-curtain winding roller last). Remember, the opening-curtain pinion shaft is the one which does *not* have the E-ring groove.

Working from the top of the camera, feed the opening-curtain pinion shaft through the teflon bearing (the bearing that's closer to the front of the camera). You must now assemble the winding-roller parts before you completely seat the pinion shaft. Slip the spacer over the lower end of the pinion shaft, Fig. 173. Then, pass the pinion shaft through the two tape ends of the opening-curtain winding roller.

Make sure that the tapes come straight from the tape ends, Fig. 173. (If there's a twist in one of the tapes, the tape end may be upside down.) Then, seat the pinion shaft fully.

Align the threaded holes in the tape ends with the holes in the pinion shaft. Now, replace the pin screws that hold the tape ends.

The closing-curtain winding roller must sit to the front of the opening-curtain tapes (that's the reason for installing the

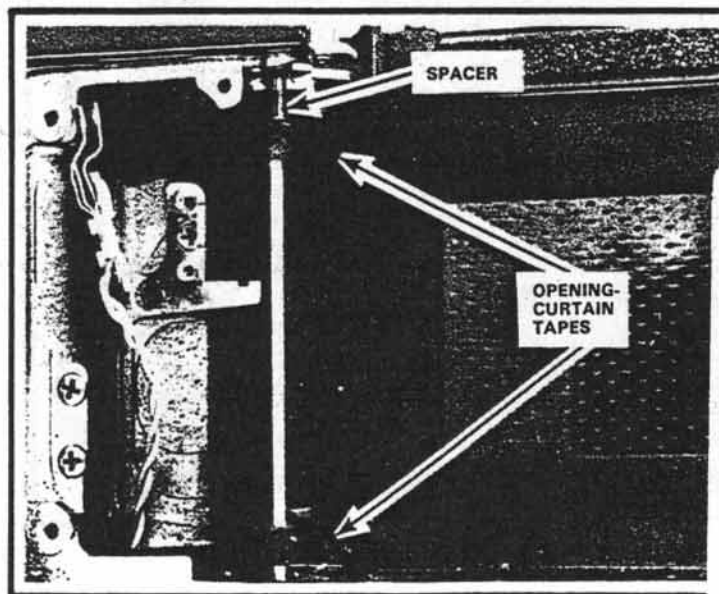

Figure 173 Opening-curtain winding roller installed

opening-curtain winding roller first). Slightly rotate the opening-curtain pinion shaft until the two tapes loop behind the closing-curtain bearing, Fig. 173. These loops allow you to assemble the closing-curtain winding roller to the front of the tapes.

Now, feed the closing-curtain pinion shaft through its teflon bearing. Make sure that the closing-curtain pinion shaft passes to the front of the upper opening-curtain tape.

As the closing-curtain pinion shaft starts through the bearing, slip the small spacer and endplay washers (if used) over the lower end. Also, slip the upper teflon guide roller over the pinion shaft. Push up the guide roller until it's positioned in front of the upper opening-curtain tape.

Next, slip the closing-curtain winding roller over the lower end of the pinion shaft. Push down the pinion shaft until it passes through the closing-curtain winding roller. When enough of the pinion shaft extends from the bottom of the closing-curtain winding roller, seat the lower teflon guide roller. Make sure the lower teflon guide roller sits to the front of the lower opening-curtain tape, Fig. 174.

Push down the upper teflon guide roller until you can see the E-ring groove in the pinion shaft. Then, replace the E-ring. Remember that the E-ring goes under the small spacer.

Now, push up the closing-curtain winding roller -- until the upper teflon guide roller is against the E-ring. Turn the pinion shaft until you can see its pin-screw hole through the screw hole in the closing-curtain winding roller. And replace the pin screw that holds the closing-curtain winding roller to the pinion shaft.

The two winding rollers should now be positioned as shown in Fig. 174. Notice again how the opening-curtain tapes pass behind the two teflon guide rollers. You can now carefully turn the camera until you're looking at the bottom ends of the winding rollers.

Seat the large spacer over the opening-curtain pinion shaft (the shaft closer to the front of the camera). And seat the small spacer over the closing-curtain pinion shaft. Remember to replace all the endplay washers you noted during disassembly.

NOTE: Replacing the endplay washers in the same positions as you noted prior to disassembly should result in the proper endplay for the pinion shafts. However, if you've replaced parts, you may have to shim the pinion shafts by adding or removing endplay washers. There should be 0.15mm endplay in each pinion shaft. Check the endplay after replacing the winding-rollers support plate. Just use your thumb to move the winding rollers up and down; you should be able to feel the slight endplay.

As you seat the winding-rollers support plate, make sure the pinion shafts pass through the teflon bearings. Then replace the three screws -- the countersunk screw toward the

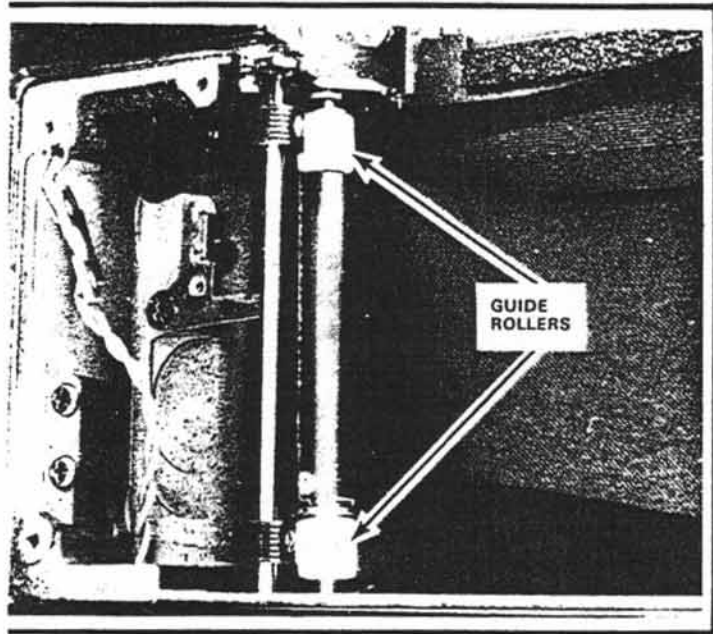

Figure 174 Closing-curtain winding roller installed

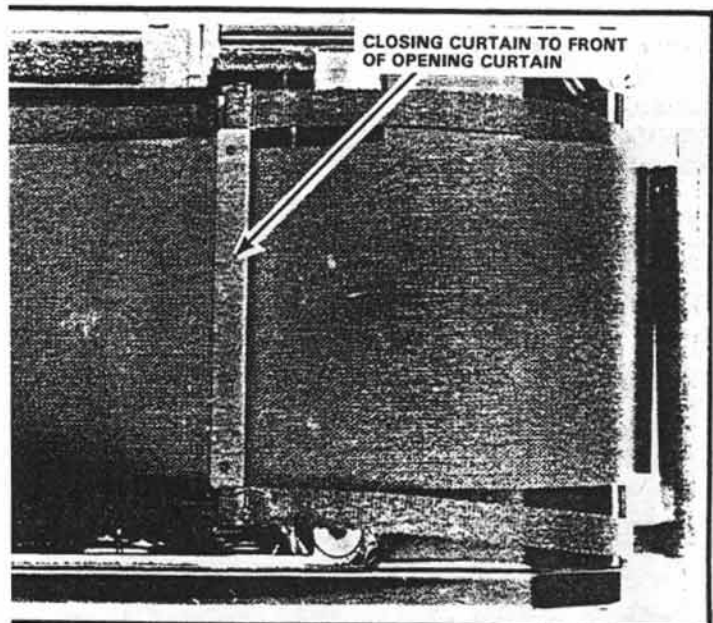

Figure 175

front of the camera, the shoulder screw in the lower left-hand corner, and the spring-hooking post at the right-hand side. All three screws serve to precisely position the winding-rollers support plate. So don't tighten any of the screws until you have them all in place. Then, snugly tighten each of the three screws.

You're now ready to replace the two take-up rollers. However, if you extend the curtains as shown in Fig. 175, you'll notice that the closing curtain sits to the front of the opening curtain. That's not what you want. The opening curtain should be in front of the closing curtain.

To reposition the curtains, grasp the closing-curtain take-up roller with your finger. Then, pass the entire closing-curtain take-up roller through the opening-curtain tapes. Once again extend the two curtains to your right -- the opening curtain should now be in front of the closing curtain, Fig. 176.

Make sure that the closing-curtain tapes are straight (it's fairly easy to get the tapes twisted as you're working with the take-up rollers). Then, seat the teflon guide roller over the top of the opening-curtain take-up roller. Make sure that the guide roller sits to the front of the upper closing-curtain tape.

Also seat the spacers on the tops of the two take-up rollers. Hold the two take-up rollers as they would normally be positioned -- the closing curtain take-up roller in front with the closing-curtain tapes passing around the guide rollers, Fig. 177. Then, pass the lower ends of the take-up rollers through their respective holes at the bottom of the camera's body casting. And seat the upper ends of the take-up rollers in their respective bearing holes at the top of the camera's body casting.

When you're sure that the take-up rollers are properly positioned, replace the take-up-rollers support plate. Hold the upper end of each central shaft with a screwdriver as you screw on the tension-setting worm gears (remember, the worm gears have left-hand threads). Then, rotate both take-up rollers to draw the curtains to the released position at the right-hand side of the aperture.

Again check to make sure the curtains are positioned properly -- be especially careful to check for twists in the tapes. Also, make sure that the closing-curtain tapes are passing around the back surfaces of the teflon guide rollers.

APPLYING THE INITIAL TENSIONS

Before timing the curtain-wind gears, you should apply the initial tensions to the take-up rollers. Later, you'll set the initial tensions precisely to adjust the curtain-travel times. However, by putting a certain number of turns on each take-up roller, you can set the tensions quite closely.

Rotate the tension-setting worm gears in a counter-clockwise direction to apply the tensions. You can tell how many turns of tension you've applied by watching the screwdriver slots in the tension-setting worm gears. Although the amount of initial tension varies according to the camera, here's a good starting point:

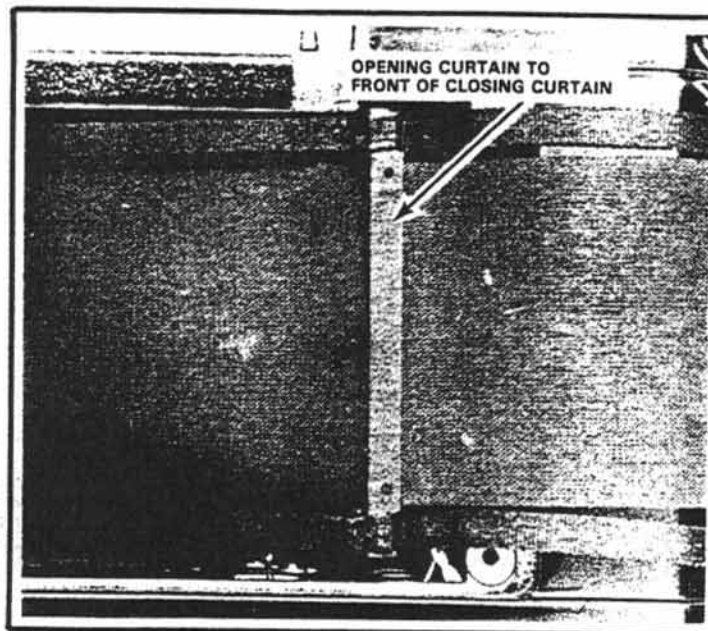

Figure 176

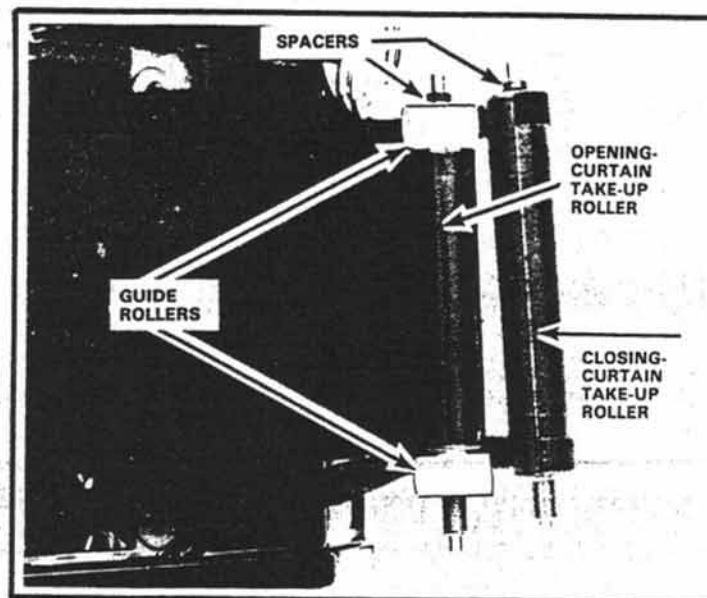

Figure 177

- Put 2 complete turns on the closing-curtain take-up roller.

- Put 1 1/2 turns on the opening-curtain take-up roller.

The "tricky" part of applying the initial tension is in finding the right starting point -- the point at which there's no initial tension on the take-up rollers. But there's a technique you can use to find the starting point, a technique you can also apply to other focal-plane shutters:

Let's say you're starting with the closing-curtain take-up roller. Insert your screwdriver (or the special tool described earlier) into the screwdriver slot in the closing-curtain tension-setting worm gear. Now, rotate the screwdriver in a counterclockwise direction until you have turned the tension-setting worm gear 5 complete turns.

This initial tension should draw the closing curtain to the closing side of the aperture. And it should take up any slack in the curtain.

Next, allow the screwdriver to rotate slowly in a clockwise direction. The initial tension on the closing-curtain take-up roller is now turning the screwdriver, letting off the initial tension. When the closing-curtain take-up roller can no longer turn the weight of the screwdriver, you've reached the proper starting position. Now, turn the screwdriver counterclockwise to rotate the tension-setting worm gear 2 complete turns.

After applying the initial tension, hold the tension-setting worm gear in position as you insert the tension-setting worm. Temporarily tighten the setscrew to hold the tension-setting worm in position. But don't as yet apply any locking agent to the setscrew. You'll later use the tension-setting worm to precisely set the curtain-travel time.

Repeat the procedure to apply the initial tension to the opening-curtain take-up roller. You can then check to make sure the curtains are tracking properly as you install and time the curtain-wind gears.

TIMING THE CURTAIN-WIND GEARS

Earlier, we mentioned the standard technique for timing the curtain-wind gears in a double-roller focal-plane shutter. Here again is the procedure:

1. Time the closing-curtain wind gear to hold the closing curtain the proper distance behind the focal-plane shutter at bulb.
2. Time the opening-curtain wind gear for the proper curtain overlap during the cocking cycle.

To time the closing-curtain wind gear, you'll need the closing-curtain latch installed. You can then simulate the latching action of the closing curtain. Temporarily seat the closing-curtain latch over the mechanism-plate post. You don't have to replace the retaining nut. Nor do you have to connect the closing-curtain-latch spring.

Now, use your thumb to turn the closing-curtain winding roller in a counterclockwise direction. That winds on the closing curtain. Continue winding on the curtain until the lead edge of the closing-curtain bar aligns with your scribe mark (the scribe mark you made prior to disassembly).

While holding the closing-curtain winding roller, seat the closing-curtain wind gear as shown in Fig. 178. Notice the position of the latching lug in Fig. 178 -- it points to the small hole in the mechanism plate. Now, swing the closing-curtain latch into engagement with the latching lug as shown in Fig. 179.

The lead edge of the closing-curtain bar should still be aligned with your scribe mark, Fig. 180. What if it's not? Then, you have to change the timing between the closing-curtain wind gear and the closing-curtain winding-roller pinion, Fig. 179.

Lift the closing-curtain wind gear slightly -- just enough to disengage the closing-curtain wind gear from the closing-curtain winding-roller pinion. Then, rotate the closing-curtain winding roller in one direction or the other to align the bar with your scribe mark.

Turn the closing-curtain winding roller clockwise if you want to move the bar closer to the edge of the focal-plane aperture; turn the closing-curtain winding roller counterclockwise if you want to move the bar further from the edge of the focal-plane aperture.

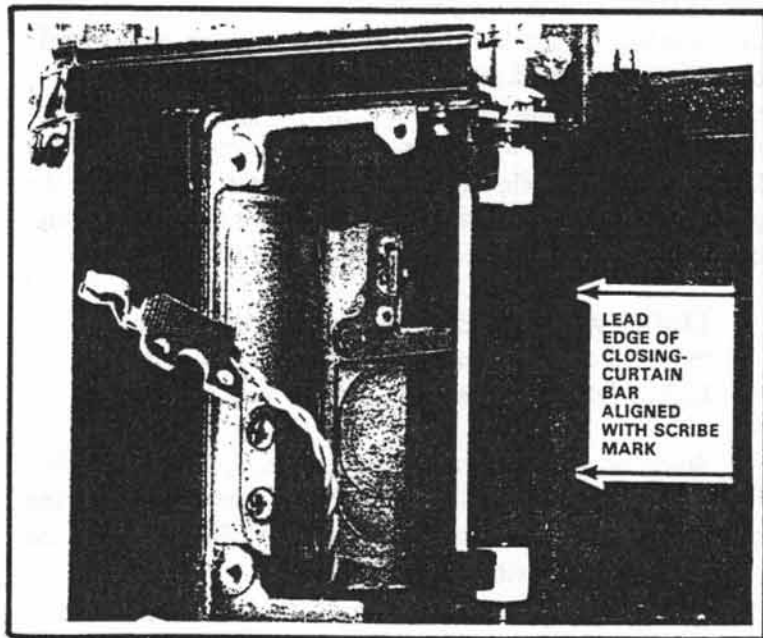

Figure 180

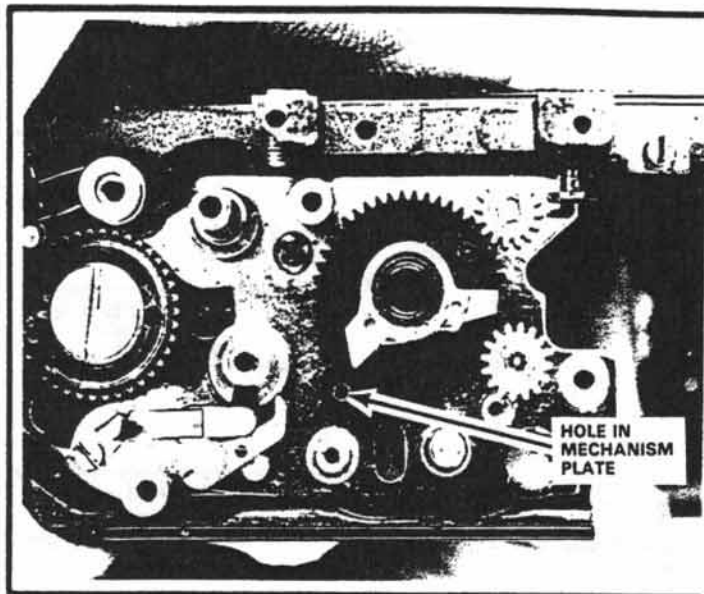

Figure 178

Rotate the closing-curtain winding roller to wind on the closing curtain. When the closing-curtain bar aligns with its scribe mark, seat the closing-curtain wind gear as shown here.

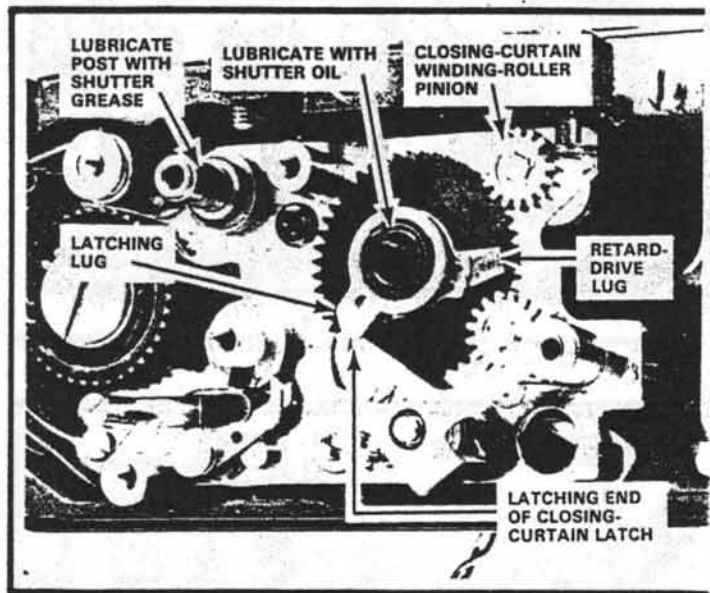

Figure 179

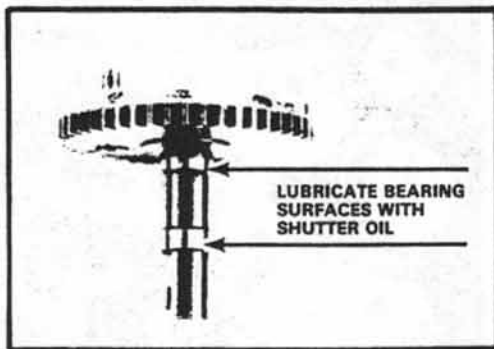

Figure 181 Opening-curtain wind gear

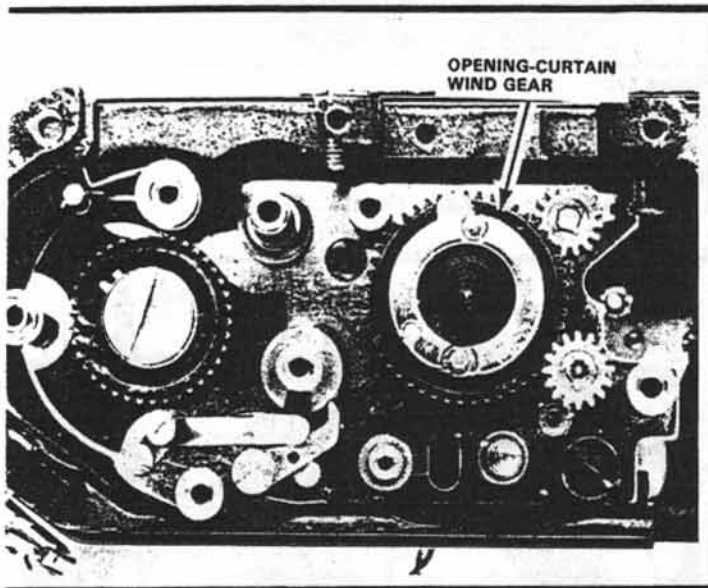

Figure 182

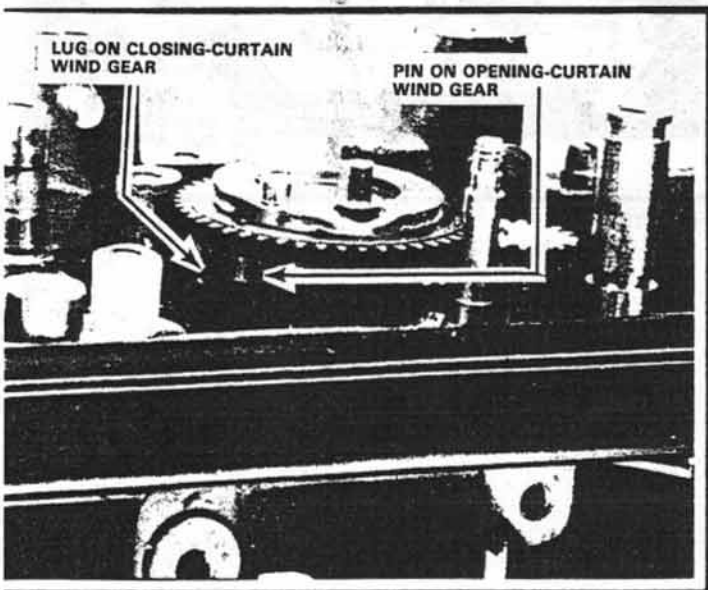

Figure 183

Once you've timed the closing-curtain wind gear, you can lift out the closing-curtain latch. The closing-curtain latch just gets in your way when you're installing the opening-curtain wind gear.

Removing the closing-curtain latch should allow the closing curtain to move across the aperture. But you'll probably find that the closing curtain won't release. Or it'll just move part way across the aperture. The reason is that the opening curtain has moved too far in the release direction. As a result, the opening curtain binds the closing curtain.

Try rotating the opening-curtain winding roller slightly in a counterclockwise direction (as seen from the top). You're now winding on the opening curtain. That should free the closing curtain. The closing curtain should then fire across the aperture to the released position.

LUBRICATION: Lubricate the inside bearing surface of the closing-curtain wind gear with shutter oil. Just place a tiny drop of oil between the bearing surfaces, Fig. 179. The oil will then work its way around the inner surface of the closing-curtain wind gear as you operate the shutter.

Lubricate the latching lug and the retard-drive lug with shutter grease. Wipe a very light coat of grease on the latching surface of the latching lug, Fig. 179. Also, lightly grease the sloped side of the retard-drive lug as well as the side that comes against the upper retard-rod lever. Remember, the sloped side passes under the upper retard-rod lever during the cocking cycle (if you've set the shutter to a retard speed).

You won't have to make any further changes on the timing of the closing curtain wind gear. But it's a little tricky to time the opening-curtain wind gear. That's because you must install the opening-curtain latching cam at the same time as you're seating the opening-curtain wind gear. You can't install the opening-curtain latching cam after you've replaced the opening-curtain wind gear -- there isn't enough room.

There's one more problem -- the pin on the underside of the opening-curtain wind gear must sit against the side of the latching lug of the closing-curtain wind gear. Remember, the pin on the opening-curtain wind gear must turn the closing-curtain wind gear during the cocking cycle.

LUBRICATION: Notice the two bearing surfaces on the shaft of the opening-curtain wind gear, Fig. 181. Lightly lubricate these two surfaces with shutter oil.

Start the opening-curtain wind gear into position as shown in Fig. 182. Make sure that the pin at the bottom of the opening-curtain wind gear sits counterclockwise of the lug on the closing-curtain wind gear, Fig. 183.

Before fully seating the opening-curtain wind gear, fit the opening-curtain latching cam over the shaft, Fig. 184. The insulated stud on the opening-curtain latching cam (the stud that closes the X-sync contacts) should be to your left as you're looking at the front of the camera. You should now be able to seat the opening-curtain wind gear fully.

What if the opening-curtain wind gear won't seat fully? In that case, the pin on the opening-curtain wind gear is probably coming on top of the latching lug of the closing-curtain wind gear. Just rotate the closing-curtain winding roller to partially wind on the closing curtain. That moves the latching lug away from the pin. When the lug clears the pin, the opening-curtain wind gear should drop into place.

Don't as yet replace the screw that holds the opening-curtain latching cam. You must first check the timing of the opening-curtain wind gear. Use your thumb to rotate the opening-curtain wind gear in a clockwise direction. The opening curtain should then pick up and turn the closing-curtain wind gear in the same direction. As you continue turning the opening-curtain wind gear, both curtains should move toward the winding-rollers side of the aperture.

During the cocking cycle, check the overlap between the two curtains. Remember, the curtains should overlap by one bar. If you've installed new curtains, it's desirable to have slightly more than a full-bar overlap. That's because the new curtains may stretch slightly. Fig. 185 shows the ideal overlap.

Here's a convenient way to precisely check the overlap:

Rotate the opening-curtain wind gear until the curtains are about half-way across the aperture. Hold the opening-curtain wind gear with one finger. Then, use your other hand to turn the closing-curtain winding roller. Rotate the closing-curtain winding roller to move the closing curtain away from the opening curtain, Fig. 186.

Now allow the closing-curtain winding roller to turn slowly in the release direction. Watch the curtain bars as the closing curtain moves under the opening curtain. By allowing the closing curtain to move slowly, you can fairly easily see how much overlap you have.

If the overlap isn't right, you'll have to adjust the timing. Change the timing between the opening-curtain wind gear and the opening-curtain winding-roller pinion. Adjusting the timing here can present a problem; when you lift the opening-curtain wind gear to change its position, the opening-curtain latching cam may come off the shaft.

Hold the opening-curtain winding roller with one finger. Then, lift the opening-curtain wind gear slightly -- just enough to disengage the opening-curtain winding-roller pinion (but not enough to allow the opening-curtain latching cam to drop off the shaft). Then, rotate the opening-curtain winding roller in one direction or the other to correct the overlap.

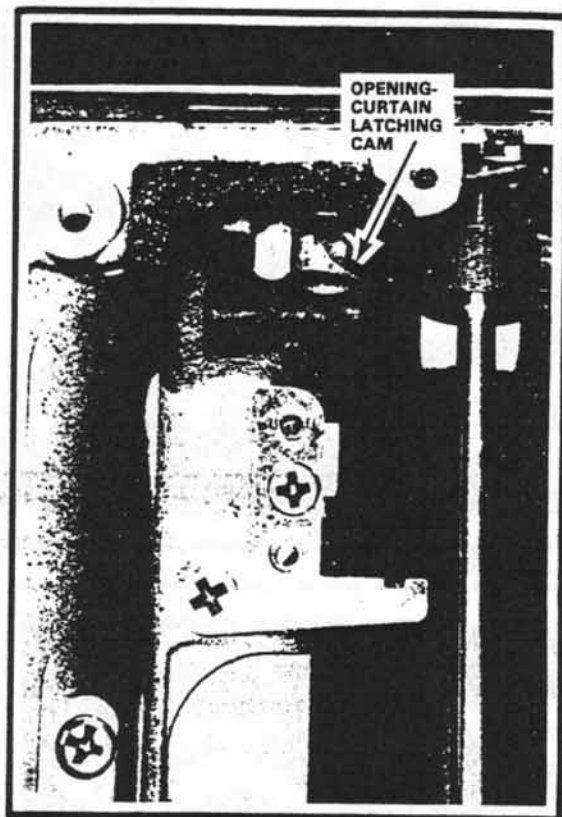

Figure 184

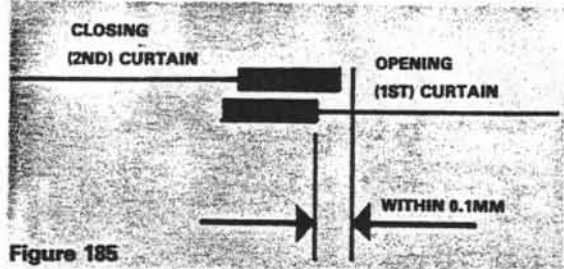

Figure 185

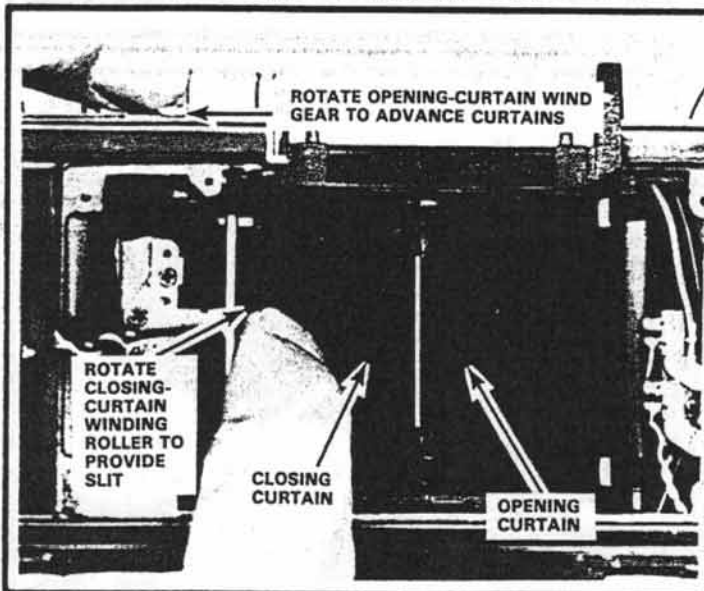

Figure 186

While checking the overlap, you can also check to see that the slit formed between the two curtains is uniform. The two curtain bars should be parallel with one another, providing a uniform slit.

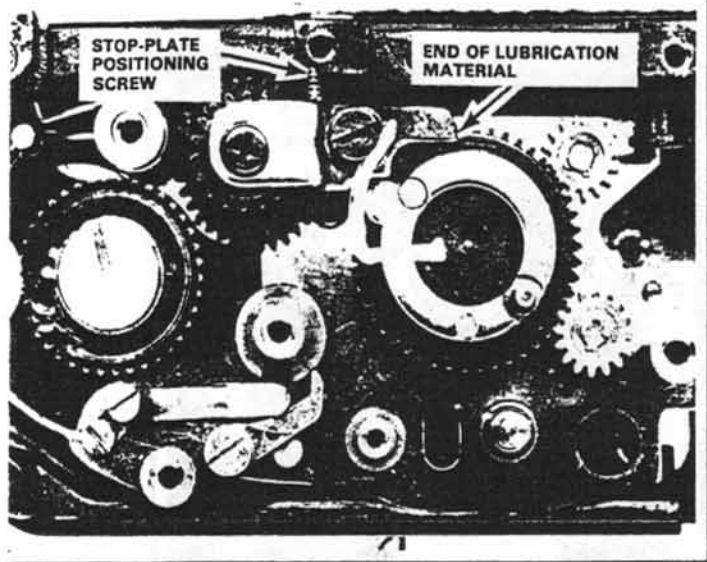

Figure 187

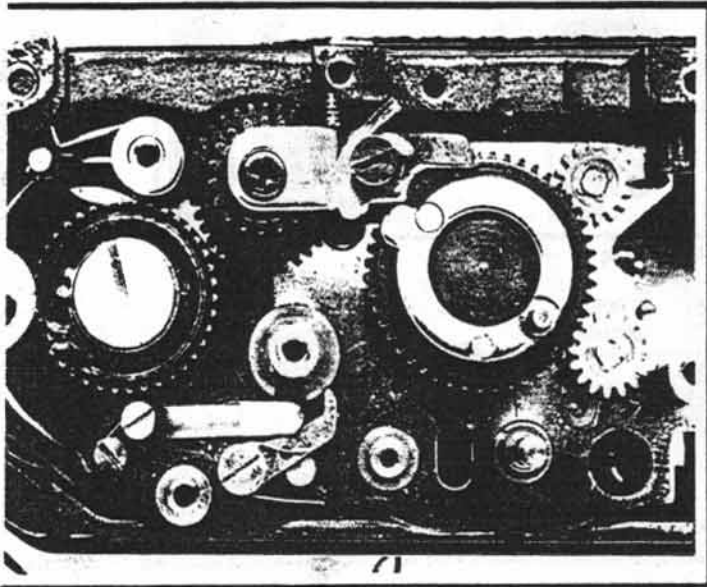

Figure 188

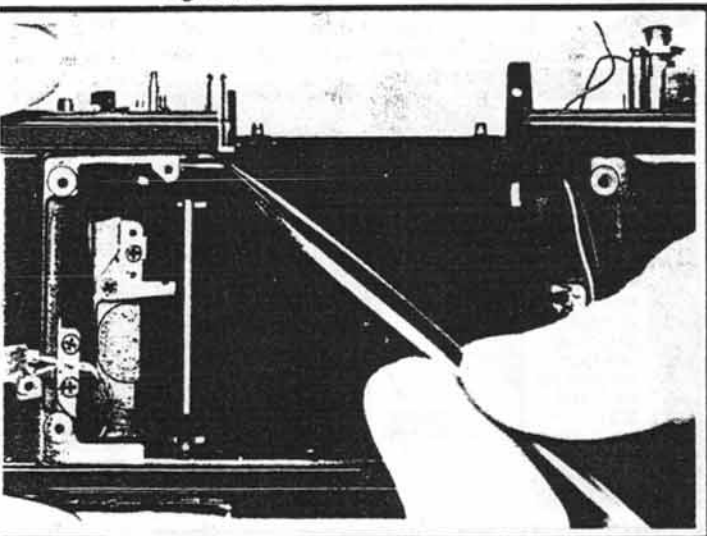

Figure 189
Release the shutter by disengaging the opening-curtain latch.

Turning the opening-curtain winding roller clockwise (as seen from the top) decreases the overlap; turning the opening-curtain winding roller counterclockwise increases the overlap.

Once you've adjusted the overlap, replace the screw which holds the opening-curtain latching cam. Now, everything's locked in place -- you won't lose your curtain timing. However, don't as yet apply any locking agent to the screw that holds the opening-curtain latching cam; wait until you've rechecked the timing with a few more parts in place.

Rotate the opening-curtain wind gear in a clockwise direction until it's latched by the opening-curtain latch. Then, replace the two-piece reduction gear and reassemble the wind-gear stop plate.

Be careful when you're positioning the lubrication tube -- only the end of the material should extend beyond the wind-gear stop plate, Fig. 187.

Now, hold the wind-gear stop plate against the stop-plate positioning screw. And tighten the two screws holding the wind-gear stop plate. Finally, tuck the lubrication tube around the long-headed screw as shown in Fig. 188.

Once you've assembled the wind-gear stop plate, push in the opening-curtain latch to free the opening curtain. The closing-curtain should cross the aperture at the same time. Why? Because you haven't as yet replaced the closing-curtain latch.

Replace the closing-curtain latch and the bulb lever as one assembly. Then, again turn the opening-curtain wind gear to the cocked position. When you disengage the opening-curtain latch, the closing curtain should remain held.

Check once more to see if the closing curtain aligns with its scribe mark. If it does, release the closing curtain by pushing the closing-curtain latch out of engagement. You can now apply a touch of red lacquer to the screw holding the opening-curtain latching cam.

You'll notice that we haven't replaced the parts in the exact reverse order of disassembly. Rather, we replaced the parts in the most convenient sequence for checking the curtain timing. From here, you can reverse your order of disassembly. Replace the light-trap plate. Then, cock the shutter (by turning the opening-curtain wind gear) and replace the X-sync contact assembly. Also reassemble the release shaft.

Now, seat the brake lever in position (remember the washer that goes under the brake lever). Replace the brake-lever screw and connect the brake spring.

Remember, the lug on the opening-curtain wind gear strikes the brake lever during the counterclockwise release rotation, Fig. 190. The spring-loaded brake lever then applies a cushioning action to the opening curtain. As the opening-

curtain wind gear completes its rotation, it pushes aside the brake lever, Fig. 191. The wind-gear stop plate now arrests the counterclockwise rotation of the opening-curtain wind gear, Fig. 191.

REPLACING THE MIRROR-RETURN GEAR AND THE WINDING-ROLLER PINION

Replace the winding-roller pinion with the shutter in the released position. Take a close look at the screw hole in the winding-roller pinion. Notice that one end of the screw hole is countersunk; the countersunk end receives the screwhead. So, when you replace the winding-roller pinion, you'll want the countersunk end of the screwhead facing the back of the camera. You'll then be able to reach the screwhead through the camera-body cutout, Fig. 192.

The screw hole in the closing-curtain pinion shaft must also face the back of the camera. But you'll notice that the screw hole in the closing-curtain pinion shaft does not align with the camera-body cutout. That means you'll have to rotate the closing-curtain winding roller until one end of the screw hole does face the back of the camera.

Reach inside the camera and rotate the closing-curtain winding roller a partial turn, Fig. 193. As you're turning the closing-curtain winding roller to wind on the closing curtain, watch the pinion shaft. Stop turning the closing-curtain winding roller when the screw hole points to the camera-body cutout.

Now, hold the closing-curtain winding roller in place. And seat the winding-roller pinion over the closing-curtain pinion shaft. Remember, the pinion teeth go down, and the countersunk end of the screw hole faces the back of the camera.

The screw hole in the winding-roller pinion should now align with the screw hole in the pinion shaft. Working through the cutout in the body casting, replace the screw to hold the winding-roller pinion.

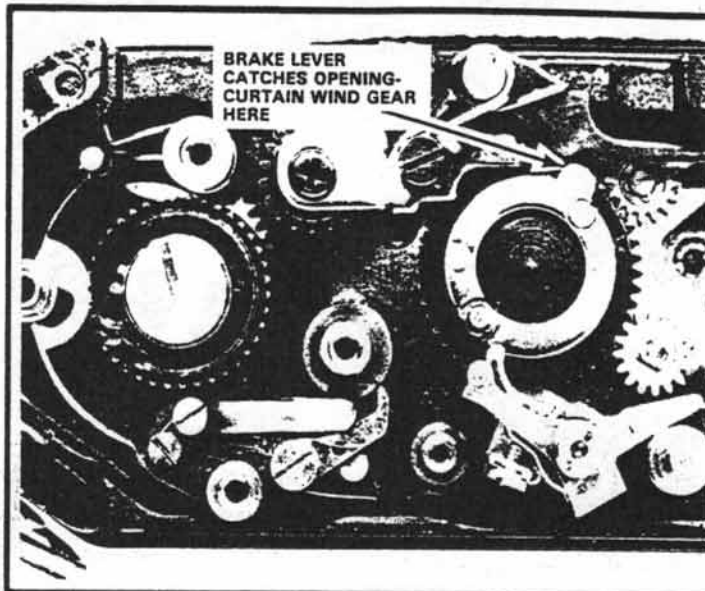

Figure 190

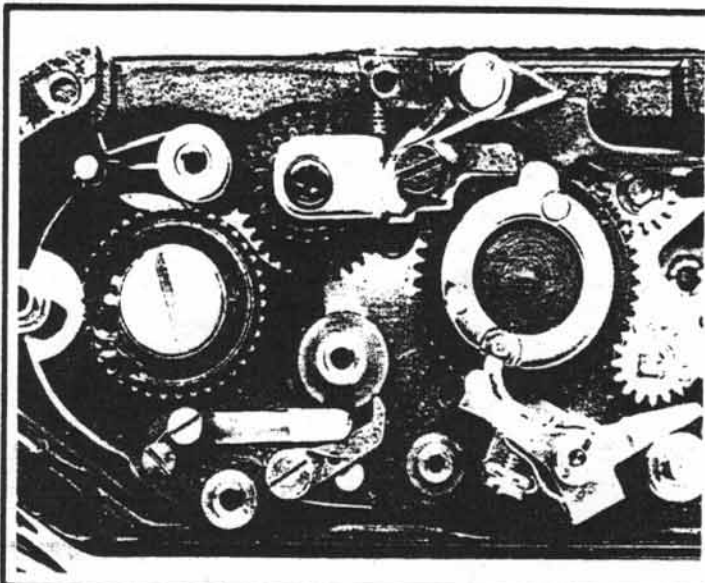

Figure 191

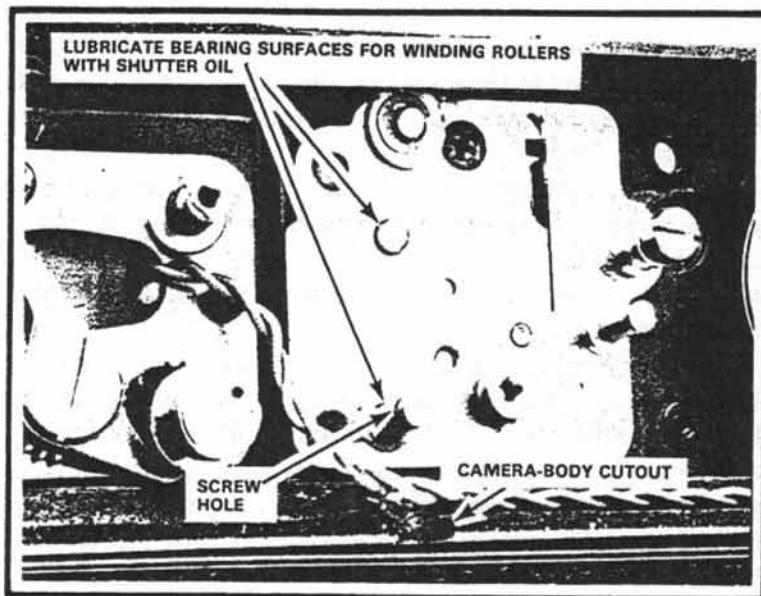

Figure 192

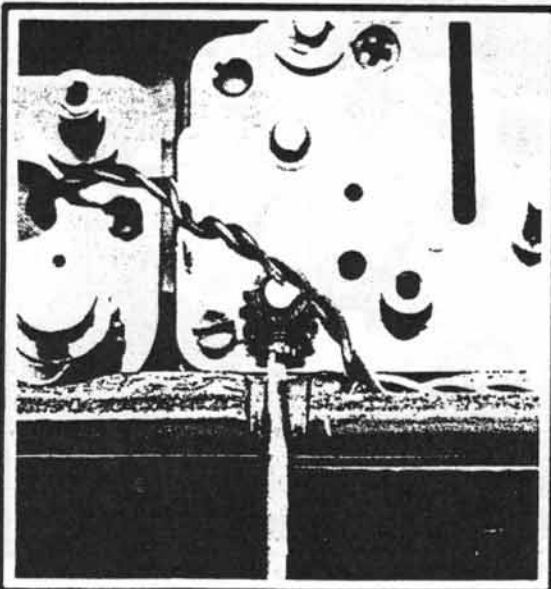

Figure 193 Replacing the winding-roller pinion

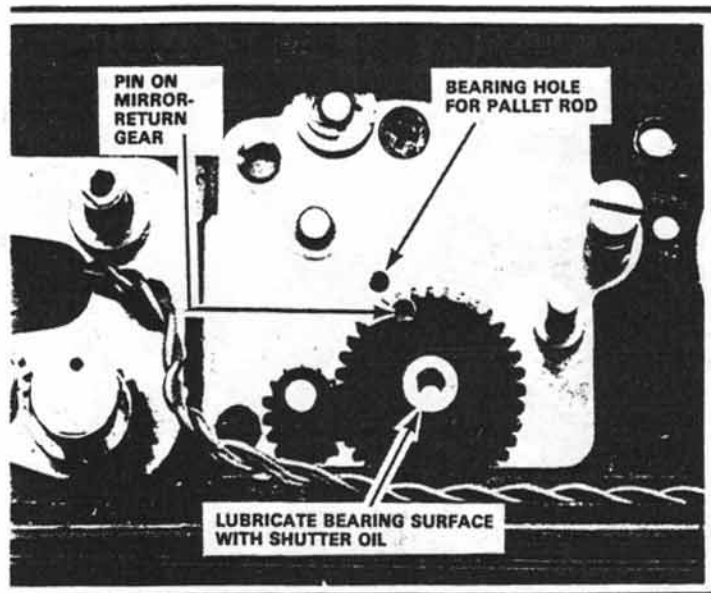

Figure 194

You're then ready to replace the mirror-return gear. Rotate the opening-curtain wind gear all the way to the cocked position. Next, seat the mirror-return gear over its support bearing -- make sure that the pin on top of the mirror-return gear points directly to the bearing hole for the pallet rod, Fig. 194.

LUBRICATION: Before replacing the screw for the mirror-return gear, you can lubricate the bearing surface. Place just a drop of shutter oil between the inside bearing surface of the mirror-return gear and the support bearing. The oil will work its way around the bearing surfaces as you operate the camera.

Leave the shutter in the cocked position to replace the mirror-catch lever. Locate the groove around the shaft of the

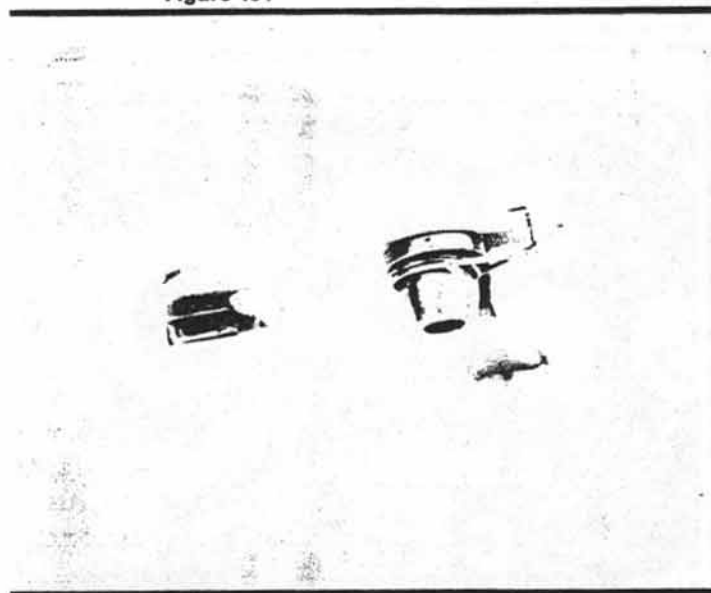

Figure 195

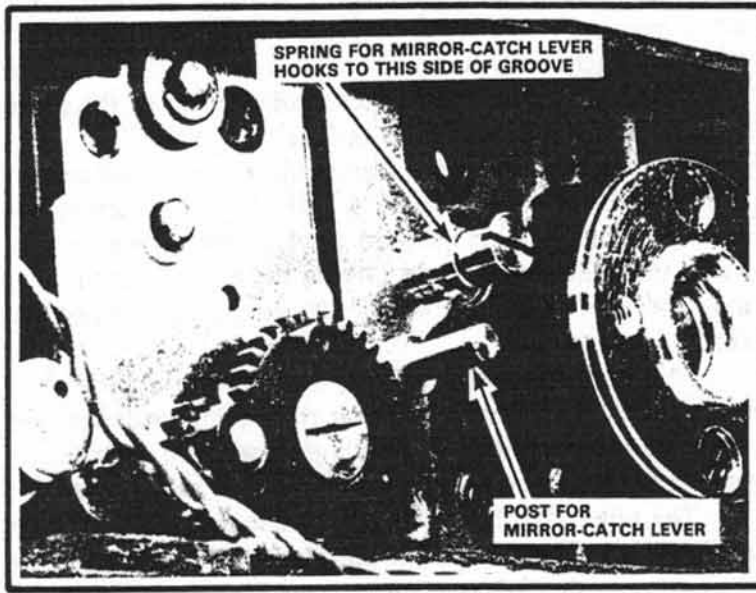

Figure 196

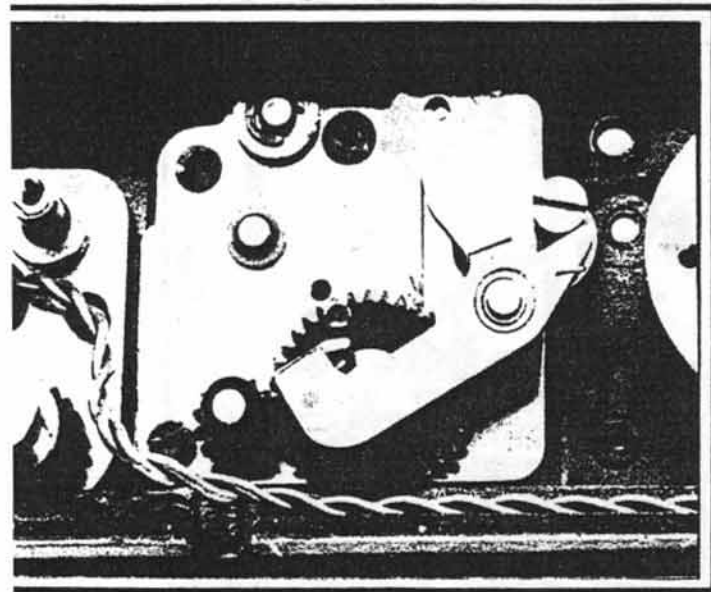

Figure 197 Shutter cocked

mirror-catch lever -- the coil of the mirror-catch-lever spring seats around this groove. Seat the spring over the shaft of the mirror-catch lever as shown in Fig. 195; notice that the hooked end of the spring goes up and connects to the side of the mirror-catch lever.

You can then seat the mirror-catch lever and its spring as one assembly. As you seat the mirror-catch lever over its post, hold the straight end of the spring against its tension; the straight end must hook to the left-hand side of the spring-hooking post, Fig. 196.

Fig. 197 shows the proper position of the mirror-catch lever. Since the shutter is cocked, the end of the mirror-catch lever sits behind the pin of the mirror-return gear. Check to make sure the spring is properly connected -- the straight end within the groove of the spring-hooking post and the hooked end against the side of the mirror-catch lever. Then, replace the E-ring.

LUBRICATION: Lubricate the latching end of the mirror-catch lever with shutter grease -- this is the surface that engages the mirror-tensioning lever of the mirror cage.

REPLACING THE TRANSPORT GEARS

There are several critical timing points to consider when you replace the transport gears. Although you disassembled the transport gears with the shutter released, you'll want the shutter cocked for reassembly (you'll see why in a moment). Rotate the opening-curtain wind gear, Fig. 198, to the cocked position.

Now is a good time to check the overtravel of the opening-curtain wind gear. Remember, you should have a 0.2mm space gap between the lug on the opening-curtain wind gear and the side of the wind-gear stop plate, Fig. 198. If necessary, adjust the stop-plate positioning screw from the back of the camera.

Before replacing the transport gears, time the wind-shaft gear, Fig. 198. You can now turn the wind-shaft gear continuously in a clockwise direction; a slip spring on the wind shaft prevents reverse rotation.

Turn the wind-shaft gear to the position shown in Fig. 198. Notice that the counter-dial actuator points to the support post. Also, if you draw an imaginary line through the support post as shown in Fig. 198, the line passes across the two holes in the wind-shaft gear.

Why's this timing important? It determines the position of the lower wind gear at the bottom of the wind shaft, Fig. 199. The post on the lower wind gear should now be pointing to the body-casting screw hole as shown in Fig. 199.

If you've properly timed the wind-shaft gear, Fig. 198, the lower wind gear should be properly positioned. But you won't be able to change the timing once you've replaced the transport gears. Pentax does provide a technique for changing the position of the post, Fig. 199, without removing the transport gears. However, the technique requires that you replace a part.

The mirror-cocking plate mounted on top of the lower wind gear includes the post, Fig. 199. And you can get different versions of the mirror-cocking plate. Each version has a slightly different angle for the center hole, Fig. 200. So, by using a different mirror-cocking plate, you can change the position of the post without disturbing the wind-shaft gear.

Replacing parts, though, isn't a convenient adjustment. So make sure you properly time the wind-shaft gear, Fig. 198, before assembling the transport gears. The position of the post, Fig. 199, should then be within tolerance.

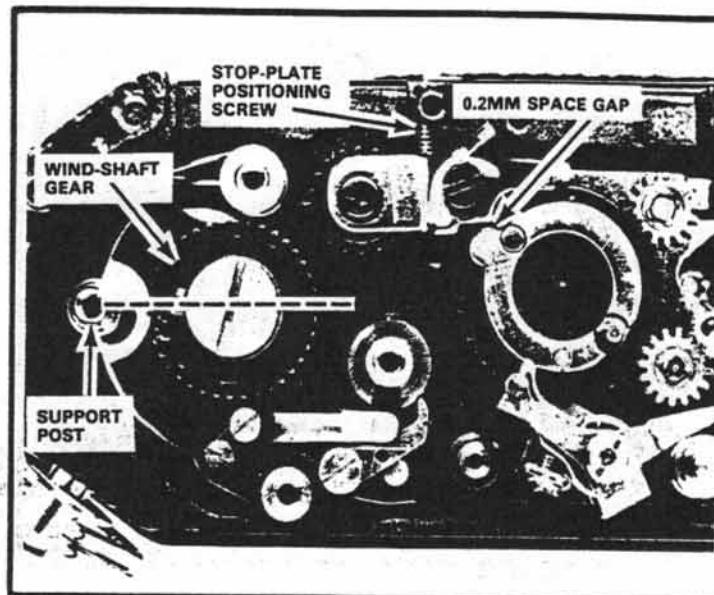

Figure 198 Shutter cocked

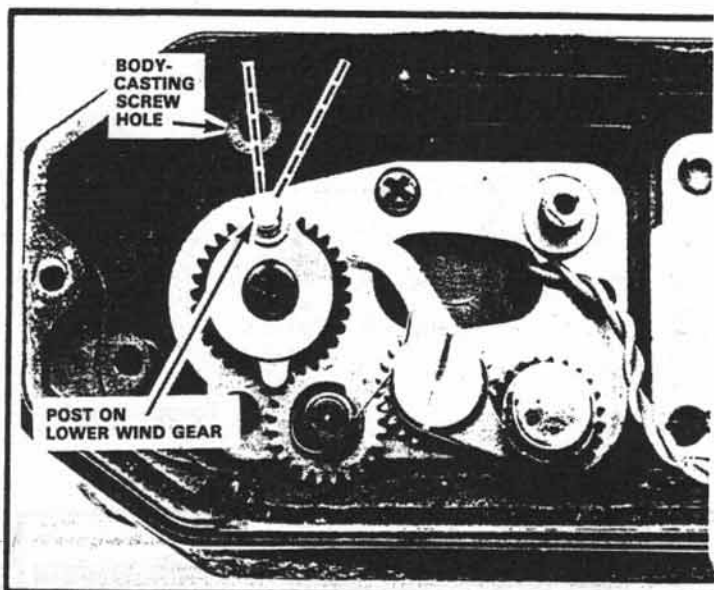

Figure 199 Tolerance- Post can be 10° to right of screw hole

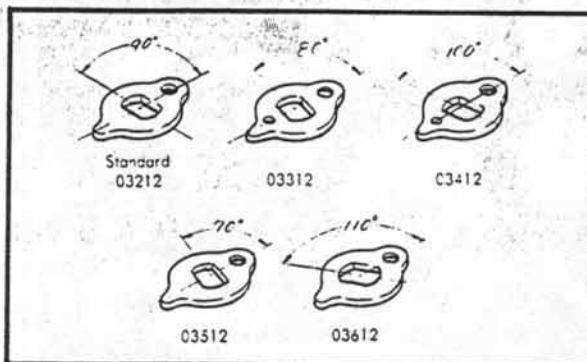

Figure 200

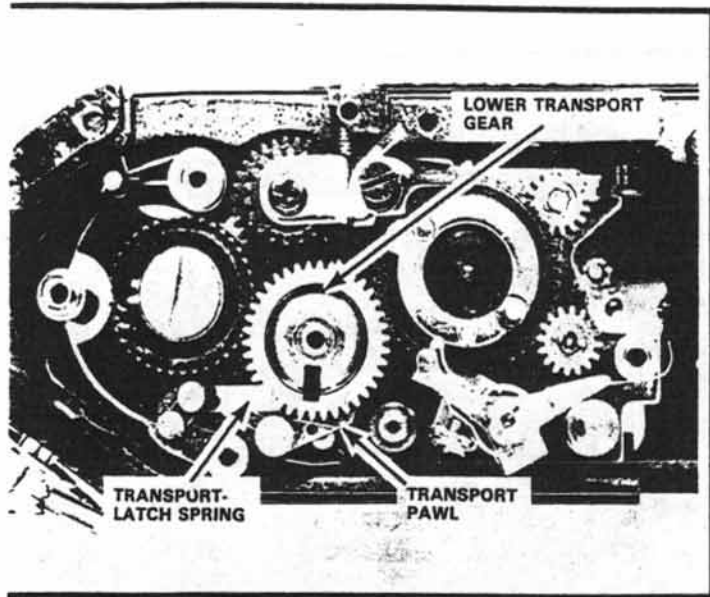

Figure 201

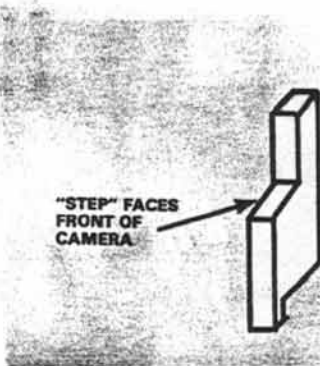

Figure 202 Transport latch

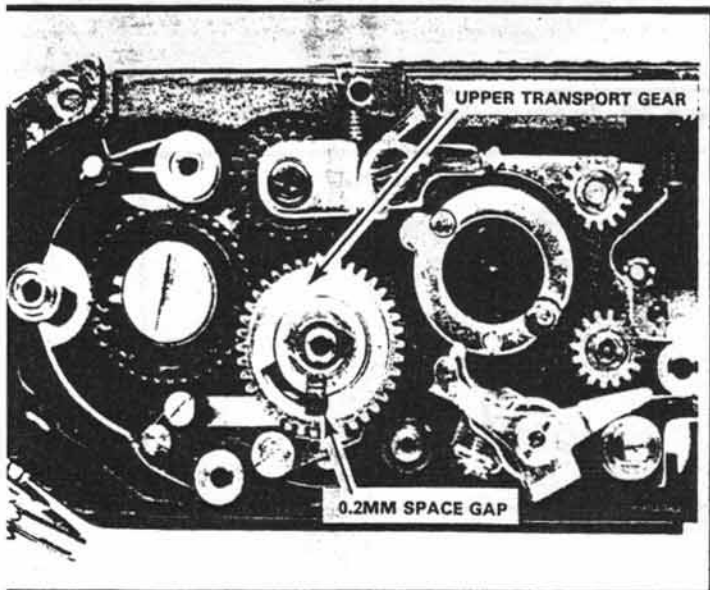

Figure 203

Now, seat the lower transport gear as shown in Fig. 201. Notice in Fig. 201 that the slot in the lower transport gear is over the end of the transport-latch spring.

Hold the transport pawl, Fig. 201, away from the lower transport gear -- against the tension of the transport-pawl spring. You should then be able to fully seat the lower transport gear. Here's how you can check to make sure the lower transport gear is at its correct starting position:

While watching the transport pawl, Fig. 201, rotate the lower transport gear very slightly in a counter-clockwise direction; you should see the transport pawl move away from the lower transport gear. Then, rotate the lower transport gear clockwise until you see the transport pawl drop into engagement. When the transport pawl drops into the notch at the bottom of the lower transport gear, you know the starting point is correct.

You'll probably have to hold down the lower transport gear as you complete the reassembly; otherwise, the transport-latch spring may push up the lower transport gear. The transport pawl may then slip underneath the lower transport gear, preventing the parts from seating fully.

Now, replace the transport latch. Remember, the step on the transport latch faces the front of the camera, Fig. 202.

The most critical timing step comes when you replace the upper transport gear. Seat the upper transport gear as shown in Fig. 203. Notice that the end of the gear slot is almost -- but not quite -- touching the transport latch. There should be a 0.2mm space gap between the side of the transport latch and the end of the gear slot, Fig. 203.

It's not necessary to try and measure the space gap. But you want the end of the gear slot as close as you can get it to the side of the transport latch. Yet the parts must not actually touch. If you don't have the space gap, Fig. 203, the transport latch may bind.

Normally, you won't have a problem getting the proper timing. But you may run into the situation where the space gap, Fig. 203, is too large. Yet when you move the upper transport gear one tooth, you find that the end of the gear slot touches the transport latch.

You can then make a minor modification to the upper transport gear. Use the gear position at which the end of the gear slot touches the side of the transport latch. To get the 0.2mm clearance, slightly file the end of the gear slot, Fig. 204.

Once you've timed the upper transport gear, replace the retaining disc and the screw, Fig. 205. The screw has a shoulder which fits through the retaining-disc hole. Make sure the shoulder passes through the hole as you replace the screw. If you aren't careful here, the screw may bind the retaining disc. The screw will then work loose as you operate the camera.

You can now check the timing of the transport gears. Release the opening curtain by first pushing down the transport latch and then disengaging the opening-curtain latch. Release the closing curtain by pushing the closing-curtain latch out of engagement with the closing-curtain wind gear.

Next, rotate the wind-shaft gear in a clockwise direction to cock the shutter. As the transport gears near the cocked position, watch the transport pawl.

You should see the transport pawl drop into engagement slightly before the opening-curtain latch engages the opening-curtain latching cam.

With a little practice, you can watch both the transport pawl and the opening-curtain latch. Rotate the wind-shaft gear very slowly as the shutter nears the cocked position. Again, the transport pawl should drop into engagement first. The opening-curtain latch should drop into engagement slightly after the transport pawl engages the lower transport gear.

Leave the shutter in the cocked position to test the freedom of the transport latch. Here's a technique you can use to assure that the transport latch moves freely:

Use a screwdriver to hold down the transport latch. Then, use another screwdriver to turn the wind-shaft gear fully in a clockwise direction

While holding the wind-shaft gear fully clockwise, let go of the transport latch -- the transport latch should remain depressed. Now, stop applying pressure to the wind-shaft gear. The transport latch should then spring up on its own. If the transport latch pops up as soon as you release the wind-shaft gear, you know that there's no bind. What if the transport latch remains depressed? You'll then have to disassemble the transport gears and recheck the timing. Apparently, the space gap, Fig. 203, isn't sufficient.

If the transport gears pass these tests, replace the release-rod plate. Then, again test the release action. Push down the release shaft to depress the transport latch. And disengage the opening-curtain latch to free the opening curtain.

REPLACING THE SPEED-SELECTOR ASSEMBLY

Now, reassemble the counter-drive parts and the support-shaft assembly as described on page 74. Also replace the main-

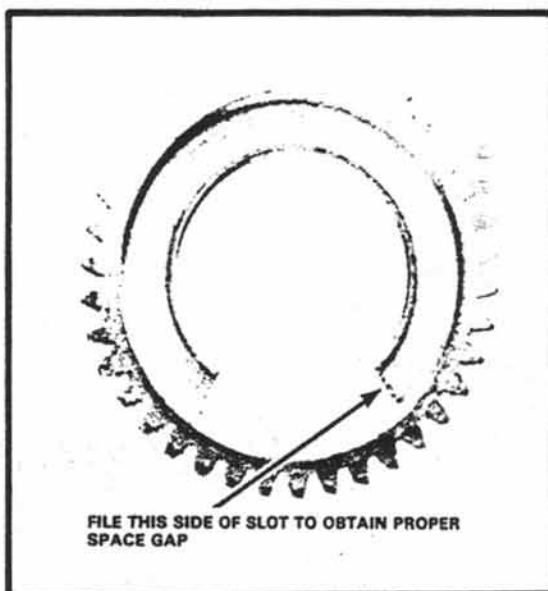

Figure 204 Upper transport gear

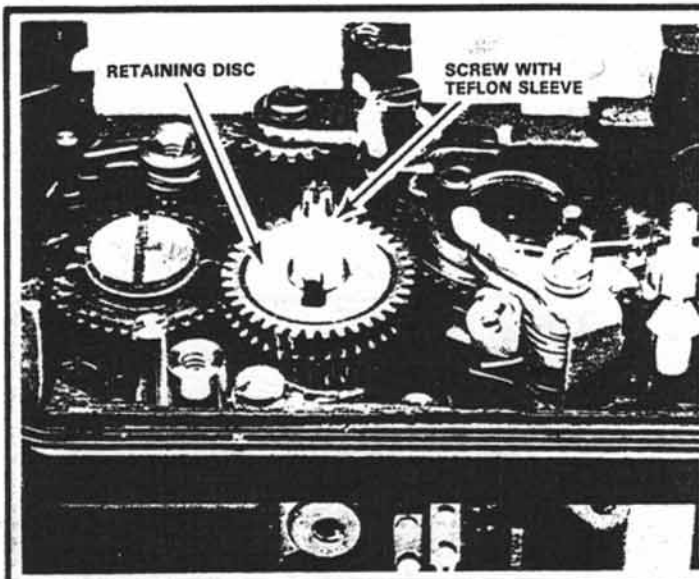

Figure 205

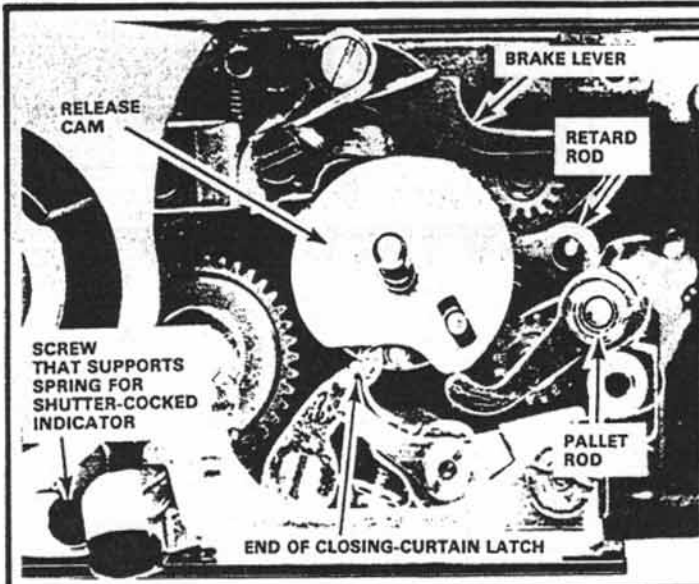

Figure 206 Shutter cocked

wind gear, the wind driver, and the wind lever. The reassembly procedure for the wind driver is on page 71.

You're now ready to complete the reassembly at the top of the camera. Advance the wind lever to cock the shutter. Then, replace the shutter-cocked indicator. Make sure that the tail of the shutter-cocked indicator is clockwise of the small pin on the opening-curtain wind gear.

Release the shutter before replacing the spring for the shutter-cocked indicator. Seat the spring coil over the screwhead, Fig. 206. Connect the hooked end of the spring to the side of the support-shaft plate; connect the curved end of the spring to the notch in the side of the shutter-cocked indicator.

Before proceeding, check the action of the shutter-cocked indicator by cocking and releasing the shutter. Make sure that the small pin on the opening-curtain wind gear doesn't slip under the tail of the shutter-cocked indicator. Also, *check to see that the tail of the shutter-cocked indicator clears the opening-curtain wind gear.* If the shutter-cocked indicator drags on the opening-curtain wind gear, the opening curtain may have an erratic movement.

Leave the shutter in the cocked position to complete the reassembly of the speed-selector components. Seat the retard rod in its lower bearing hole (the bearing hole closer to the back of the camera). Place the compression spring on the upper pivot of the retard rod, Fig. 206.

Now, seat the pallet rod in the bearing hole closer to the front of the camera (remember to slip the spacer over the lower pivot before seating the pallet rod). Place the pallet-cam follower on the upper end of the pallet rod, Fig. 206.

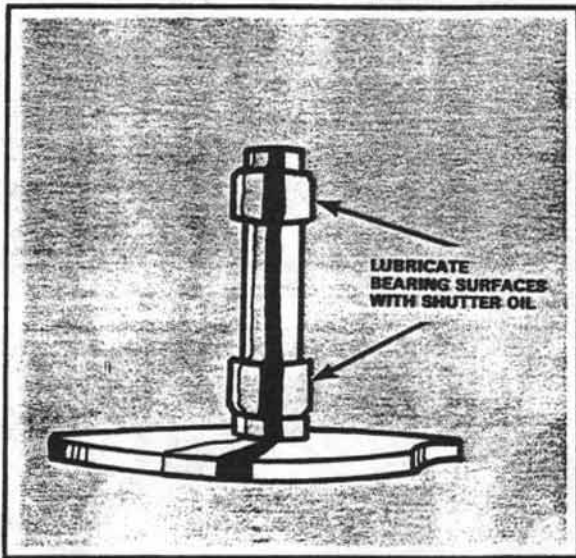

Figure 207 Release cam

LUBRICATION: The release cam, you'll recall, must be clean and lubricated. Lubricate the two bearing surfaces of the release cam, Fig. 207, with shutter oil. Use the shutter oil sparingly – you only want lubrication on the bearing surfaces. Also make sure that you've thoroughly cleaned the speed-selector assembly, especially the bearing hole which receives the release-cam shaft.

Place the brass collar over the larger pin on the opening-curtain wind gear. Then, seat the release cam, Fig. 206. The rectangular slot in the release cam fits over the larger of the two pins on the opening-curtain wind gear (the pin which has the brass collar).

You can now see why we're replacing the release cam with the shutter in the cocked position. The release cam then clears the end of the closing-curtain latch, Fig. 206. In the shutter-released position, the closing-curtain latch tends to sneak underneath the release cam.

Seating the speed-selector assembly is the delicate part of the reassembly. Start the speed-selector assembly into place by feeding its center hole over the release-cam shaft. Next, seat

the speed selector far enough to pass the retard rod through the hole in the slow-speed coupler, Fig. 208.

You'll also have to help the pallet rod into place -- make sure the upper pallet-rod pivot passes through the bearing hole in the speed-selector plate. Then replace the three screws and test the operation.

SETTING THE CURTAIN TENSIONS

Replace the speeds escapement before adjusting the curtain tensions. You can then set the curtain tensions and adjust the shutter speeds with one trip to the test equipment.

Accurately setting the curtains tensions does require special test equipment -- equipment that will measure the curtain-travel times. With a focal-plane shutter, the two curtains should travel at very close to the same speed. And if they don't? Then, the exposure won't be uniform from one side of the aperture to the other.

That's why manufacturers give you **curtain-travel times** -- how long it should take for the curtains to travel from one side of the aperture to the other. You can adjust the shutter speeds without knowing the manufacturer's travel-time specification. But you'll find that the shutter speeds come in much more easily if you first set the proper curtain-travel times.

Why can't you just set up the tensions by turning the tension-setting worms a certain number of turns? If you know the proper number of turns, you can set the travel times fairly close. However, the precise amount of tension for each curtain will vary slightly from camera to camera.

For example, suppose that the manufacturer specifies a curtain-travel time of 14.5 milliseconds. If the camera is new, and the take-up-rollers springs are in good condition, it takes a certain amount of initial tension to reach this travel time. But an older camera needs more tension before the curtains will move at the proper speed.

The curtain-travel time may also vary slightly at different shutter speeds. At the bulb setting, for example, nothing restricts the opening curtain. The curtain can then travel at top speed. But at an instantaneous-speed setting, the opening curtain must kick the closing-curtain latch out of engagement. As a result, the opening curtain can't gather full momentum before entering the aperture. Changing the release point of the closing curtain by setting different shutter speeds also affects the opening-curtain travel time.

The closing-curtain travel time varies at the slow speeds. With no retard, the closing curtain has a chance to gather momentum before entering the aperture. But the speeds escapement holds back the closing curtain at the speeds slower than 1/60 second. The travel time of the closing curtain then becomes faster at the faster speeds.

Errors introduced by different shutter-speed settings aren't all that significant. You can really measure the curtain-travel time at any shutter-speed setting, depending on the test equipment. With some instruments, it's most convenient to use

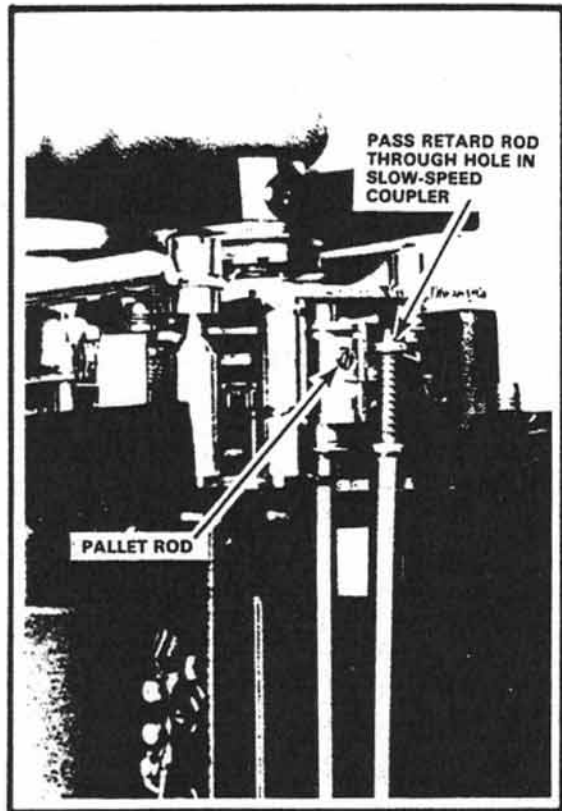

Figure 208 Seating the speed-selector assembly

the bulb setting. With other instruments, you can use the fastest shutter-speed setting.

Pentax recommends setting the travel time at the fastest shutter-speed setting -- 1/1000 second. However, you'll sometimes find that you aren't getting a slit at the fastest speed. The closing curtain may be releasing too soon or traveling too fast; it then catches up with the opening curtain.

Try opening the camera back. Then, hold up the camera to a light source as you're looking through the back of the focal-plane aperture. Cock and release the shutter at the 1/1000-second setting.

You should see a flash of light all the way across the aperture. If you see a slit at the opening side -- but not at the closing side -- you know that the closing curtain is catching up with the opening curtain.

Before going to the test equipment, then, make sure you're getting a slit all the way across the aperture. Start by setting the initial tensions to approximately the "normal" amounts:

You should have the proper initial tension on the take-up rollers. Remember, you put 2 complete turns on the closing curtain and 1-1/2 turns on the opening curtain. The travel times should now be pretty close to correct.

Now, check to see if there's a slit all the way across the aperture at 1/1000 second. You can even get a fairly good idea as to the accuracy of the exposure if you hold up the camera to a fluorescent lamp. At 1/1000 second, you should see three stripes of light running vertically across the aperture. If you see two light stripes, your 1/1000 second is closer to 1/500 second.

You can also make a visual judgment of the side-to-side variation (the evenness of the exposure across the aperture). The light stripes should be uniform in width. If the stripe at the closing side appears narrower, for example, you know that the exposure at the closing side is less than is the exposure at the opening side.

With practice, you can get fairly accurate in visually setting the side-to-side uniformity. But you still need proper test equipment for real precision (as well as for speed and efficiency). You can then set the travel times to the factory's specifications.

But, depending on the manufacturer, there may be one problem with factory specifications -- you don't always know exactly how the manufacturer measures the travel time. For example, one manufacturer may specify an edge-to-edge travel

time; that's how long the curtains should take to completely cross the focal-plane aperture. Another manufacturer may specify the travel time measured a certain distance in from each edge of the aperture.

In Pentax Spotmatic models, the edge-to-edge travel time is 14 milliseconds.

Also, many test instruments won't read an edge-to-edge travel time. A test instrument normally uses two photosensors spaced a certain distance apart. The less the distance between the two photosensors, the shorter your travel-time reading should be. It takes less time for the slit to move 34mm, for example, than it does for the slit to move 36mm.

The instruction manual for the particular instrument normally gives you the proper travel times for representative cameras. Most test instruments, though, space the photosensors 34mm or 32mm apart.

In Pentax Spotmatic models, the proper travel time for the curtains to travel the 32mm distance is 12.5 milliseconds.

Normally, you should start with the opening-curtain (1st curtain) travel-time adjustment. Adjust the opening-curtain tension-setting worm, Fig. 209, for the proper travel time. Then, adjust the closing-curtain tension, Fig. 209, for the same travel time. Some test instruments will display both travel times simultaneously. Others require that you make separate tests for the two curtains.

Next, check the side-to-side variation at the fastest shutter speed. Test the exposure at the opening side of the aperture. Then, test the exposure at the closing side of the aperture. The two exposures should match (at least within 5%). Here again, some test instruments display the exposures at the two sides of the aperture simultaneously; others require separate tests.

At this point, you aren't so concerned about the accuracy of the 1/1000-second shutter speed. You just want the same exposure all the way across the aperture. Continue to adjust the closing-curtain travel time until the exposure at the opening side of the aperture matches the exposure at the closing side.

- If the exposure at the closing side is slower than the exposure at the opening side, add tension to the closing-curtain take-up roller.
- If the exposure at the closing side is faster than the exposure at the opening side, let off tension from the closing-curtain take-up roller.

Once you've adjusted the travel times and set the side-to-side uniformity, you're ready to adjust the accuracy of the shutter speeds.

TRAVEL TIME

Edge-to-edge	— 14ms
34mm Distance	— 13.3ms
32mm Distance	— 12.5ms

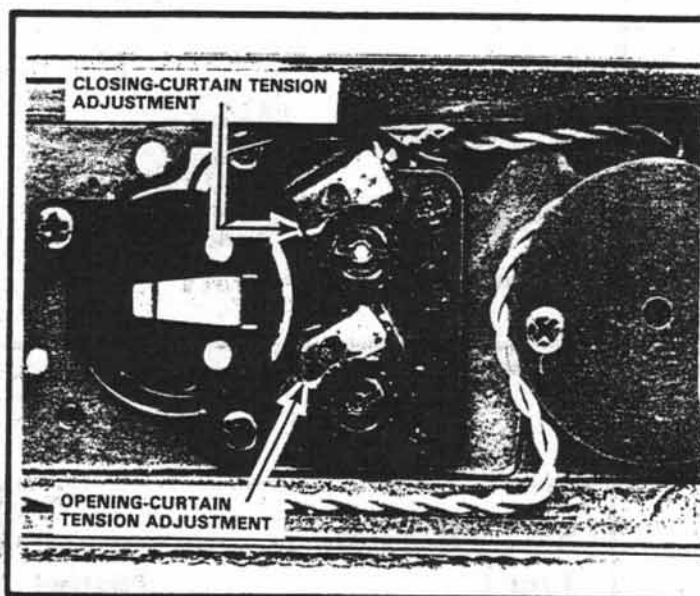

Figure 209

Turn the tension-setting worms clockwise to add tension, counterclockwise to let off tension.

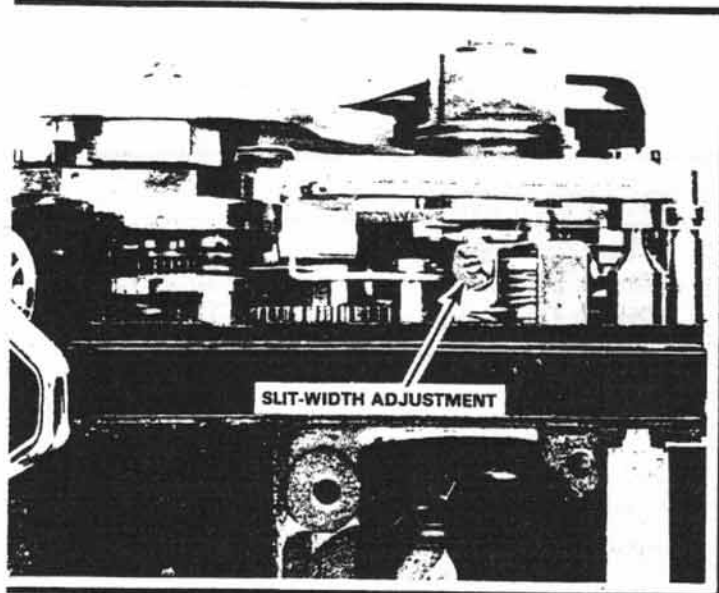

Figure 210

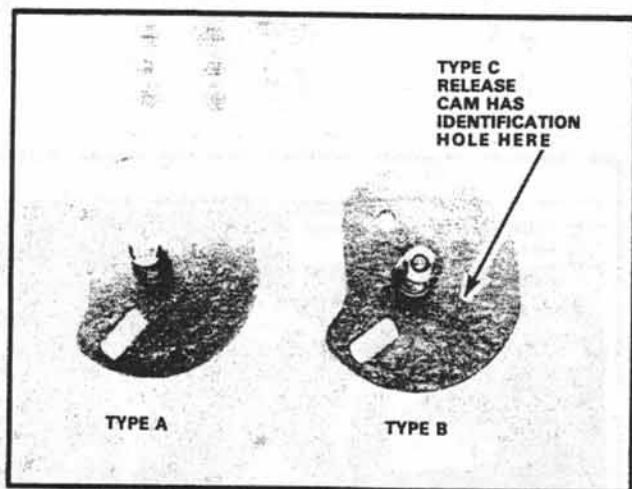
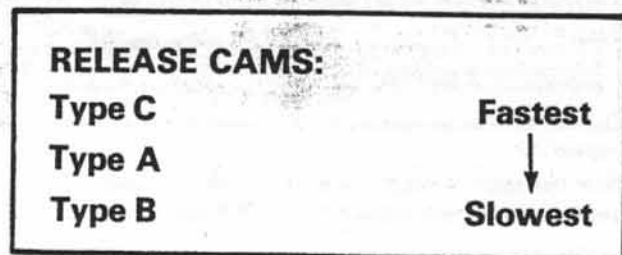

Figure 211



SHUTTER-SPEEDS ADJUSTMENTS IN THE SPOTMATIC

With the curtains set for the proper travel times, your shutter speeds should be quite close. But you may now have to make minor adjustments to the closing-curtain latch and to the slow-speed coupler.

First, check the fast speeds -- the speeds of 1/1000 second through 1/60 second. These are the slit-width speeds, the speeds determined by the release point of the closing curtain.

There are two key speeds to check in the slit-width range:

- 1/1000 second
- 1/125 second.

But you have only one adjustment for the two speeds -- the slit-width adjustment, Fig. 210. Remember, the slit-width adjustment changes the release point of the closing curtain.

Use the slit-width adjustment to bring in the two key speeds in the slit-width range. First, loosen the locking collar, Fig. 210. It helps to use a solvent, such as MEK, on the locking agent. Then, turn the locking collar about 1/4 turn in a counterclockwise direction. The special tool described earlier, Fig. 126, works well to loosen the locking collar.

You can now turn the setscrew to reposition the closing-curtain latch, Fig. 126.

- Turn the setscrew clockwise to make 1/1000-second and 1/125-second exposures faster.
- Turn the setscrew counterclockwise to make the 1/1000-second and 1/125-second exposures slower.

After making the adjustment, hold the setscrew in position as you tighten the locking collar.

In most cases, you can bring in both speeds using the one adjustment. But you will encounter the exceptions. For example, you may find that bringing in 1/1000 second makes the 1/125-second exposure too fast.

You may then have to compromise. Try to set the 1/1000-second exposure on the slow side of tolerance while putting the 1/125-second exposure on the fast side to tolerance (within 10% at 1/125 second). However, Pentax provides another adjustment technique to correct the linearity. Pentax supplies three different versions of the release cam. Fig. 211 shows two of the three types -- the Type A cam and the Type B cam.

The difference between the shapes of the two release cams, Fig. 211, isn't too obvious. However, you can identify the Type B cam by the round hole, Fig. 211. There's no identification hole in the Type A cam.

Consider that your camera has the Type B cam. But the 1/1000-second exposure is too slow. Replacing the Type B cam with the Type A cam causes the closing-curtain latch to disengage sooner. As a result, you get a faster shutter speed.

Again, any adjustment you make on the release point of the closing curtain has its greatest effect at the fastest shutter speed. You can then change the release cam to correct the

1/1000-second shutter speed. Correct the 1/125-second shutter speed by adjusting the slit-width setscrew, Fig. 210.

The third type of release cam, the Type C cam, provides a faster shutter speed. Fig. 211 shows the position of the identification hole in the Type C cam. If 1/1000-second exposure is too slow, you can then use the Type C cam to bring in the fastest speed. And again adjust the slit-width setscrew for an accurate exposure at 1/125 second.

Once you've checked and adjusted your slit-width speeds, relock the setscrew and locking collar with a locking agent (such as red fingernail polish). Then, check the slow speeds.

There are two key speeds to check in the slow-speed range:

- 1/30 second (the fastest retard speed)
- 1/8 second (the fastest speed with the pallet engaged).

Check the 1/30-second exposure first. If the exposure is too fast or too slow, make the adjustment on the slow-speed coupler, Fig. 212. Loosen the locking collar. Then, turn the setscrew clockwise for a slower exposure; turn the setscrew counterclockwise for a faster exposure.

Next, check the exposure at 1/8 second. If the exposure isn't within tolerance, you may have to make another adjustment on the slow-speed coupler, Fig. 212. Alternate between 1/30 second and 1/8 second, adjusting as necessary, until both speeds are within tolerance.

REMOVING THE WIND SHAFT AND TAKE-UP SPOOL

Many of the repairs in the K1000, as with other cameras, don't require a complete disassembly. For example, you can remove the wind shaft without taking out the mirror cage. But you do have to remove the transport gears and the mirror-cocking lever.

When would you have to remove the wind shaft? You may have to replace the take-up spool. Or you may have to clean the spring-type clutch for the wind shaft. The spring-type clutch allows the wind shaft to turn freely in the film-advance direction. But it tightens on the wind shaft to prevent reverse rotation. So, if you stop advancing the wind lever part way through the wind stroke, the curtains can't return to the released position.

If the spring-type clutch is dirty or distorted, you'll note a rough wind stroke. To remove the wind shaft, first take out the screw above the lower wind gear, Fig. 213. The screw holds the cover disc. Lift out the cover disc, Fig. 213, and the mirror-cocking plate, Fig. 214.

In Fig. 214, you can see how the mirror-cocking plate keys to the wind shaft. Remember, you can get different versions of the mirror-cocking plate if you need to reposition the post. The

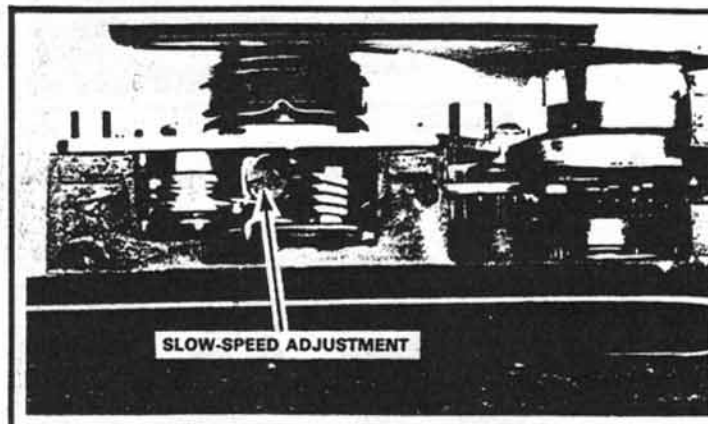

Figure 212

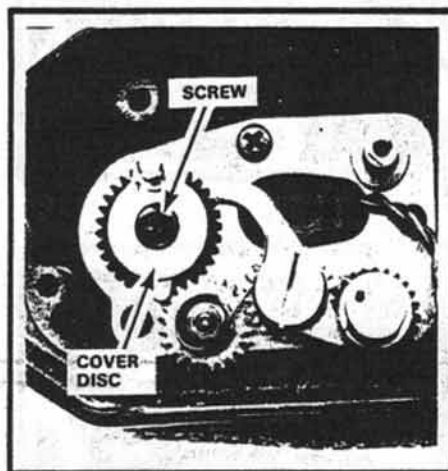

Figure 213

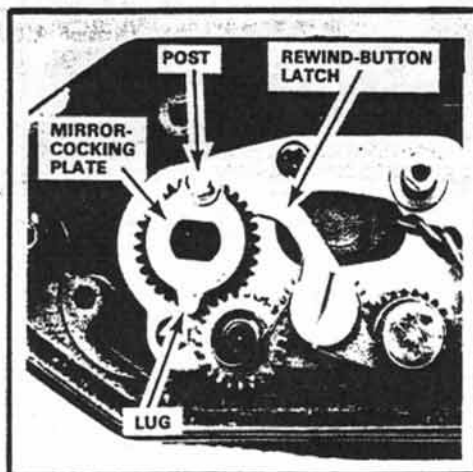

Figure 214

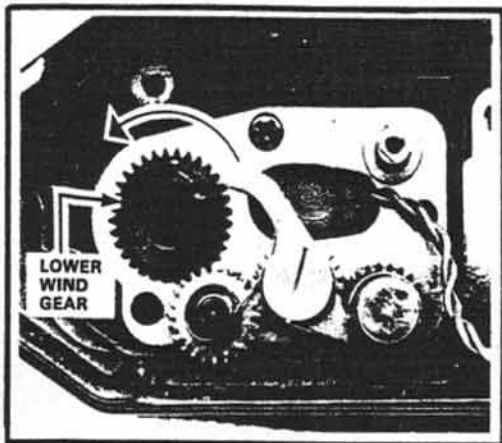

Figure 215

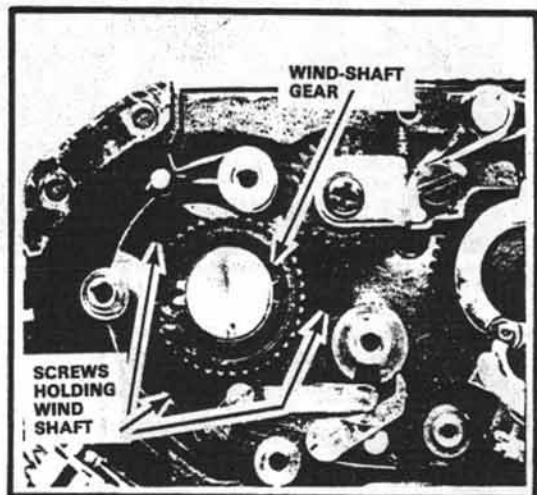

Figure 216

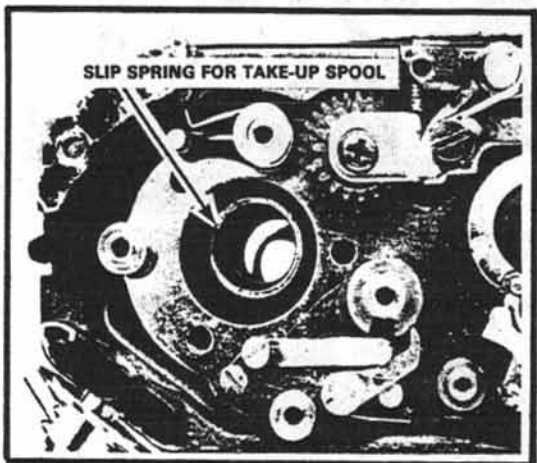

Figure 217

keyed hole in the center of the mirror-cocking plate, Fig. 214, is at a different angle in the other versions.

Also notice the lug on the mirror-cocking plate, Fig. 214. The lug disengages the rewind-button latch. When you depress the rewind button to rewind the film, the rewind-button latch drops into engagement with the sprocket shaft. The rewind-button latch then holds the sprocket shaft in the disengaged position, allowing the sprocket to turn freely in either direction. When you advance the wind lever to load a fresh roll of film, the lug shown in Fig. 214 disengages the rewind-button latch.

After lifting off the mirror-cocking plate, note the two spanner holes in the lower wind gear, Fig. 215. The lower wind gear screws onto the lower end of the wind shaft. However, to unscrew the lower wind gear, you must prevent the wind shaft from rotating.

You can now see the purpose of the two holes in the wind-shaft gear at the top of the camera, Fig. 216. Use one spanner-type wrench (such as your Multispan) to prevent the wind-shaft gear from turning. Then, use a second spanner-type wrench to unscrew the lower wind gear.

The wind shaft comes out as a complete assembly. Remove the three screws shown in Fig. 216. Then, lift out the complete wind-shaft assembly (toward the top of the camera).

Watch for the loose compression spring, Fig. 217. The compression spring provides the slipping action for the take-up spool; it allows the take-up spool to slip as the diameter of the exposed film increases. Lift out the compression spring from the top of the camera.

Now, open the camera back and remove the take-up spool. The take-up spool has two sections, Fig. 218; the bottom section fits inside the top section. Be careful of the loose washers. A large brass washer fits over the shaft of the bottom section, Fig. 218. A steel washer fits within the recess at the upper end of the top section.

How about the spring-type clutch for the wind shaft? It's part of the wind-shaft assembly you just removed. Replacement parts for wind-shaft assembly come as a complete unit. So, if the spring-type clutch is defective, you must replace the complete wind-shaft assembly.

But you can disassemble the wind shaft for cleaning and lubricating the parts. Test the operation of the spring-type clutch by turning the wind shaft while you're holding the wind-shaft plate. The wind shaft should turn smoothly in one direction. However, when you try turning the wind shaft in the other direction, the spring-type clutch should seize the wind shaft.

If the spring-type clutch fails to prevent rotation in one direction, you'll probably have to replace the complete wind-shaft assembly. However, if you feel a rough or gritty action, the spring-type clutch may simply need cleaning and lubrication. You can then disassemble the wind-shaft assembly.

Remove the large screw that holds the counter-dial ac-

tuator. Careful -- the counter-dial actuator has a loose spacer sitting within its center hole. A slot on the underside of the counter-dial actuator fits over a pin on the wind-shaft gear. The pin limits how far the counter-dial actuator can rotate; the counter-dial actuator can only move in a small arc.

Now, separate the parts of the wind-shaft assembly, Fig. 219. The spring-type clutch remains on the upper end of the wind shaft. One end of the spring-type clutch fits into the slot in the wind-shaft plate, Fig. 219.

You can now clean the individual parts -- especially the spring-type clutch and the wind-shaft plate. Lubricate the spring-type clutch with a light-grease lubricant. On reassembly, make sure the end of the spring-type clutch passes into the slot in the wind-shaft plate.

REPLACING THE SPROCKET IN THE K1000

Both the rewind button and the sprocket gear, Fig. 220, are threaded in place; the rewind button screws onto the sprocket rod, and the sprocket gear screws onto the sprocket-advance bushing. Both parts are difficult to unscrew -- they have left-hand threads and there are no spanner holes.

However, there's a shortcut technique you can use to quickly replace a sprocket. Just remove the mirror-cocking lever and the lower wind gear at the bottom of the camera (remember, the lower wind gear screws onto the wind shaft). Then, take out the three screws holding the lower mechanism plate, Fig. 220.

Lift the lower mechanism plate away from the camera body. Working from inside the film chamber, you can now slide the sprocket from the sprocket rod. Careful -- the sprocket-rod spring and a bushing at the top of the sprocket will be loose.

When you replace the sprocket, make sure the slotted end goes down. A slot in the bottom of the sprocket fits over a small brass collar. And the brass collar fits over the end of the screw which passes through the sprocket rod.

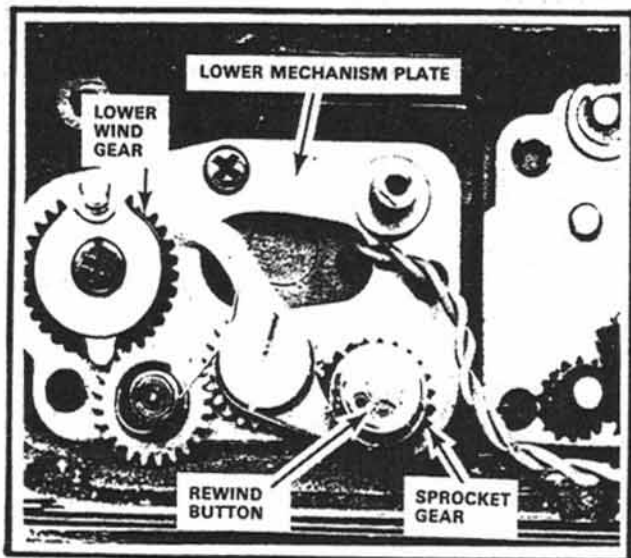

Figure 220

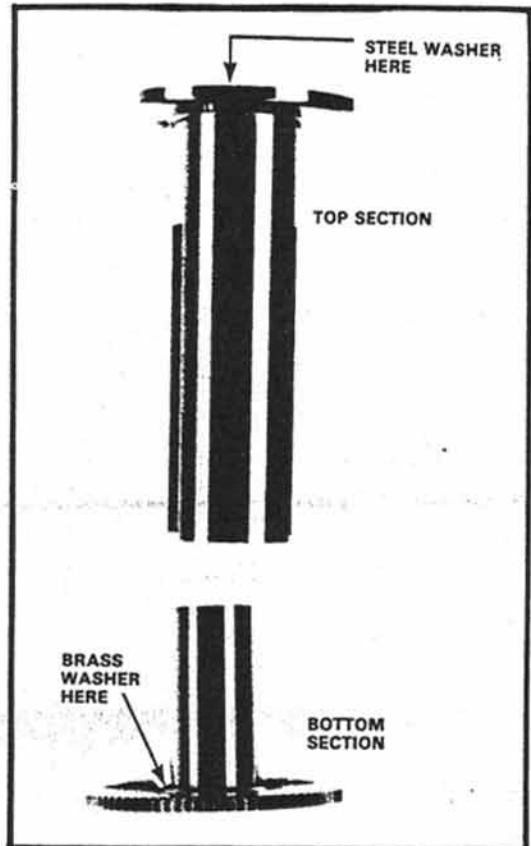

Figure 218

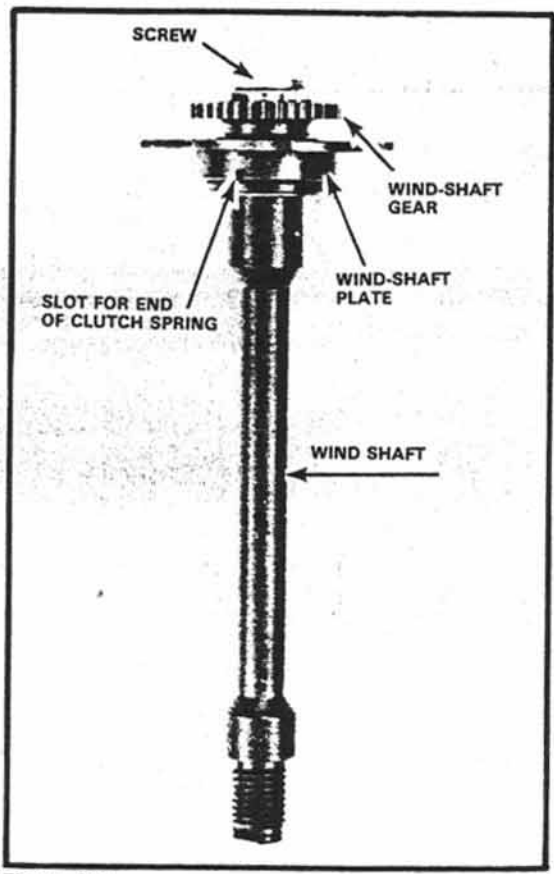

Figure 219
This is how you get a replacement wind-shaft assembly; you can't obtain individual replacement components.