

α77

SONY®

4-291-132-13 (1)

Interchangeable Lens
Digital Camera

α77

Instruction Manual

A-mount

Preparing the camera

Shooting and viewing
images

Shooting images to suit your
subject

Using the shooting
functions

Using the playback
functions

Functions list

Viewing images on a
computer

Others

Advanced operations

Index

Additional information on this product and answers to frequently asked questions can be found at our Customer Support Website.

<http://www.sony.net/>

Printed using VOC (Volatile Organic Compound)-free vegetable oil based ink.



4291132130

© 2011 Sony Corporation Printed in Thailand

α

SLT-A77/SLT-A77V

Owner's Record

The model and serial numbers are located on the bottom.

Record the serial number in the space provided below.

Refer to these numbers whenever you call upon your Sony dealer regarding this product.

Model No. SLT-A77/A77V

Serial No. _____

WARNING

To reduce fire or shock hazard, do not expose the unit to rain or moisture.

IMPORTANT SAFETY INSTRUCTIONS SAVE THESE INSTRUCTIONS. DANGER - TO REDUCE THE RISK OF FIRE OR ELECTRIC SHOCK, CAREFULLY FOLLOW THESE INSTRUCTIONS.

If the shape of the plug does not fit the power outlet, use an attachment plug adaptor of the proper configuration for the power outlet.

Caution

Battery pack

If the battery pack is mishandled, the battery pack can burst, cause a fire or even chemical burns. Observe the following cautions.

- Do not disassemble.
- Do not crush and do not expose the battery pack to any shock or force such as hammering, dropping or stepping on it.
- Do not short circuit and do not allow metal objects to come into contact with the battery terminals.
- Do not expose to high temperature above 60°C (140°F) such as in direct sunlight or in a car parked in the sun.
- Do not incinerate or dispose of in fire.
- Do not handle damaged or leaking lithium ion batteries.
- Be sure to charge the battery pack using a genuine Sony battery charger or a device that can charge the battery pack.

- Keep the battery pack out of the reach of small children.
- Keep the battery pack dry.
- Replace only with the same or equivalent type recommended by Sony.
- Dispose of used battery packs promptly as described in the instructions.

Battery charger

Even if the CHARGE lamp is not lit, the battery charger is not disconnected from the AC power source (mains) as long as it is connected to the wall outlet (wall socket). If some trouble occurs while using the battery charger, immediately shut off the power by disconnecting the plug from the wall outlet (wall socket).

The power cord (mains lead), if supplied, is designed specifically for use with this camera only, and should not be used with other electrical equipment.

For Customers in the U.S.A. and Canada

RECYCLING LITHIUM-ION BATTERIES

Lithium-Ion batteries are recyclable.

You can help preserve our environment by returning your used rechargeable batteries to the collection and recycling location nearest you.



For more information regarding recycling of rechargeable batteries, call toll free 1-800-822-8837, or visit <http://www.rbrclion.org/>

Caution: Do not handle damaged or leaking Lithium-Ion batteries.

Battery Pack and lens

This device complies with Part 15 of the FCC Rules, Operation is subject to the following two conditions:

(1) This device may not cause harmful interference, and (2) this device must

accept any interference received, including interference that may cause undesired operation.

This Class B digital apparatus complies with Canadian ICES-003.

For Customers in the U.S.A.

UL is an internationally recognized safety organization.

The UL Mark on the product means it has been UL Listed.

If you have any questions about this product, you may call:

Sony Customer Information Center
1-800-222-SONY (7669)

The number below is for the FCC related matters only.

Regulatory Information

Declaration of Conformity
Trade Name: SONY
Model No.: SLT-A77V
Responsible Party: Sony Electronics Inc.
Address: 16530 Via Esprillo,
San Diego, CA 92127 U.S.A.
Telephone No.: 858-942-2230

This device complies with Part 15 of the FCC Rules. Operation is subject to the following two conditions: (1) This device may not cause harmful interference, and (2) this device must accept any interference received, including interference that may cause undesired operation.

CAUTION

You are cautioned that any changes or modifications not expressly approved in this manual could void your authority to operate this equipment.

Note:

This equipment has been tested and found to comply with the limits for a Class B digital device, pursuant to Part 15 of the FCC Rules.

These limits are designed to provide reasonable protection against harmful interference in a residential installation. This equipment generates, uses, and can radiate radio frequency energy and, if not installed and used in accordance with the instructions, may cause harmful interference to radio communications. However, there is no guarantee that interference will not occur in a particular installation. If this equipment does cause harmful interference to radio or television reception, which can be determined by turning the equipment off and on, the user is encouraged to try to correct the interference by one or more of the following measures:

- Reorient or relocate the receiving antenna.
- Increase the separation between the equipment and receiver.
- Connect the equipment into an outlet on a circuit different from that to which the receiver is connected.
- Consult the dealer or an experienced radio/TV technician for help.

The supplied interface cable must be used with the equipment in order to comply with the limits for a digital device pursuant to Subpart B of Part 15 of FCC Rules.

For Customers in Canada

This device complies with RSS-310 of Industry Canada. Operation is subject to the condition that this device does not cause harmful interference.

For Customers in Europe



Hereby, Sony Corporation, declares that this SLT-A77V Interchangeable Lens Digital Camera is in compliance with the essential requirements and other relevant provisions of the Directive 1999/5/EC. For details, please access the following URL: <http://www.compliance.sony.de/>

Notice for the customers in the countries applying EU Directives

The manufacturer of this product is Sony Corporation, 1-7-1 Konan Minato-ku Tokyo, 108-0075 Japan. The Authorized Representative for EMC and product safety is Sony Deutschland GmbH, Hedelfinger Strasse 61, 70327 Stuttgart, Germany. For any service or guarantee matters please refer to the addresses given in separate service or guarantee documents.

This product has been tested and found compliant with the limits set out in the R&TTE Directive for using connection cables shorter than 3 meters (9.8 feet).

Attention

The electromagnetic fields at the specific frequencies may influence the picture and sound of this unit.

Notice

If static electricity or electromagnetism causes data transfer to discontinue midway (fail), restart the application or disconnect and connect the communication cable (USB, etc.) again.

Disposal of Old Electrical & Electronic Equipment (Applicable in the European Union and other European countries with separate collection systems)



This symbol on the product or on its packaging indicates that this product shall not be treated as household waste. Instead it shall be handed over to the applicable collection point for the recycling of electrical and electronic equipment. By ensuring this product is disposed of correctly, you will help prevent potential negative consequences for the environment and human health, which could otherwise be caused by inappropriate waste handling of this product. The recycling of materials will help to conserve natural resources. For more detailed information about recycling of this product, please contact your local Civic Office, your household waste disposal service or the shop where you purchased the product.

Disposal of waste batteries (applicable in the European Union and other European countries with separate collection systems)



This symbol on the battery or on the packaging indicates that the battery provided with this product shall not be treated as household waste.

On certain batteries this symbol might be used in combination with a chemical symbol. The chemical symbols for mercury (Hg) or lead (Pb) are added if the battery contains more than 0.0005% mercury or 0.004% lead.

By ensuring these batteries are disposed of correctly, you will help prevent potentially negative consequences for the environment and human health which could otherwise be caused by inappropriate waste handling of the battery. The recycling of the materials will help to conserve natural resources.



In case of products that for safety, performance or data integrity reasons require a permanent connection with an incorporated battery, this battery should be replaced by qualified service staff only. To ensure that the battery will be treated properly, hand over the product at end-of-life to the applicable collection point for the recycling of electrical and electronic equipment.

For all other batteries, please view the section on how to remove the battery from the product safely. Hand the battery over to the applicable collection point for the recycling of waste batteries.

For more detailed information about recycling of this product or battery, please contact your local Civic Office, your household waste disposal service or the shop where you purchased the product.

Notice for customers in the United Kingdom

A moulded plug complying with BS 1363 is fitted to this equipment for your safety and convenience.

Should the fuse in the plug supplied need to be replaced, a fuse of the same rating as the supplied one and approved by ASTA or BSI to BS 1362, (i.e., marked with an  or  mark) must be used.

If the plug supplied with this equipment has a detachable fuse cover, be sure to attach the fuse cover after you change the fuse.

Never use the plug without the fuse cover.

If you should lose the fuse cover, please contact your nearest Sony service station.

Table of Contents

Basic operations

Basic operations	14
------------------------	----

This section provides basic information on operating the camera.

Read this section first.

Notes on using your camera	15
----------------------------------	----



Preparing the camera

Checking the supplied items	18
Identifying parts	19
Charging the battery pack	25
Inserting the battery pack/memory card (sold separately)	27
Attaching a lens	30
Turning the camera on and setting the clock	33
Before shooting	35
Adjusting the viewfinder to the visual acuity (diopter adjustment)	35
Holding the camera properly	35



Shooting and viewing images

Shooting still images	36
Recording movies	38
Playing back images	39
Deleting images (Delete)	40

Shooting images to suit your subject

Adjusting the angle of the LCD monitor	41
Shooting with the various shooting modes	42
AUTO+	43
SCN Scene Selection	44
 Sweep Panorama/  3D Sweep Panorama	45
 Continuous Advance Priority AE	46

Using the shooting functions

Using the flash	47
Adjusting the brightness of the image	49
 /  Selecting the drive mode	51

Switching the recording information display (DISP)	52
Setting image size	53
Image Size	53
Panorama: Size	53

Using the playback functions

Enlarging images	55
Switching to the display of the image list	56
Viewing images on a TV screen	57

Functions list

Functions that can be operated with the buttons/dial	58
Selecting a function with the Fn (Function) button	59
Functions that can be selected with the Fn (Function) button	60
The functions selected with the MENU button	62
Using the guide function of the camera	70
In-Camera Guide	70

Viewing images on a computer

Using with your computer	71
Using the software	73
Selecting the method for creating a disc of movies	77

Others

List of icons on the screen	79
Functions available for each shooting mode	82
Flash modes available	83

Advanced operations

.....	85
-------	----



This section provides further information on the camera.

Preparation

Setting up the camera	86
Removing the eyecup	86
The screen displayed for shooting mode	87
Selecting the screen mode	87
Histogram	88
The digital level gauge	89

Graphic Display	89
Monitoring the subject through the lens without effects displayed	89
List of icons for viewfinder mode	90
Display panel	93
Shooting a clear image without camera shake	94
Camera shake warning indicator	94
Using the SteadyShot function	94
Using a tripod	95

Shooting

Selecting the shooting mode	96
AUTO AUTO	96
AUTO ⁺	96
SCN Scene Selection	97
 Sweep Panorama/ 3D 3D Sweep Panorama	99
 Cont. Priority AE	101
P Program Auto	102
A Aperture Priority	103
S Shutter Priority	105
M Manual Exposure	107
M BULB	109
Movie recording setup	111
Recording movies easily	111
Recording movies with the shutter speed and aperture adjusted	112
File Format	113
Record Setting	114
Audio Recording	115
Adjusting the focus	116
Autofocus	116
Focus-lock	119
AF area	119
The AF illuminator	120
AF Micro Adj.	121
Object Tracking	121
Manual focus	123
Peaking	124
Focus Magnifier	124

Direct manual focus	125
AF/MF control	126
Detecting faces	127
Face Detection	127
Face Registration	128
Smile Shutter	129
Adjusting the brightness of the image	131
AE Lock	131
Metering Mode	132
Flash Comp.	132
Flash control	133
The flash	135
Wireless flash	135
Slow Sync	136
Using a flash equipped with a flash sync terminal cord	137
Setting ISO	139
Multi frame noise reduction	140
Compensating for the brightness and contrast automatically (D-Range)	141
D-RangeOptimizer	141
Auto HDR	142
Setting the image processing	144
Picture Effect	144
Creative Style	145
Adjusting the color tones (White balance)	148
The fine adjustment screen for color	149
Color Temp./Color Filter	150
Custom white balance	150
Zooming in in one step	153
☺ / ☐ Selecting the drive mode	154
Shooting single shot	154
Cont. Shooting	154
Self-timer	155
Bracket: Cont./Single Bracket	155
WB bracket	157
DRO Bracket	158
Remote Cdr.	158

Playback

The screen displayed for playback mode	159
Switching the screen during playback	159
List of icons on the histogram display	159
Using the playback functions	161
Rotating an image	161
View Mode	161
Slide Show	162
Playback Display	162
Scrolling panoramic images	163
Protecting images (Protect)	164
Deleting images (Delete)	165
Delete (Multiple Img.)	165
Deleting all the images or movies in the same view mode	166
About playback on TV	167
3D Viewing	167
Using “BRAVIA” Sync	167

Setup of the camera

GPS setting (SLT-A77V only)	169
GPS Assist Data	170
GPS Auto Time Cor.	170
Setting the aspect ratio and image quality	172
Aspect Ratio	172
Quality	172
Setting the other functions of the camera	174
Long Exposure NR	174
High ISO NR	174
Color Space	175
Release w/o Lens	175
Grid Line	176
Auto Review	176
Func. of AEL button	176
ISO Button, AF/MF button	177
Preview Button	177
Electronic Front Curtain Shutter	177
LCD Brightness	178
Viewfinder Bright.	178

Power Save	179
FINDER/LCD Setting	179
Lens compensation	180
Lens Comp.: Peripheral Shading	180
Lens Comp.: Chromatic Aberration	180
Lens Comp.: Distortion	180
Setting the method for recording on a memory card	181
Format	181
File Number	181
Folder Name	181
Select REC Folder	182
New Folder	182
Recover Image DB	183
Upload Settings	183
Registering your own settings	185
Resetting to the default	186
Confirming the version of the camera	190

Computer

Connecting the camera to the computer	191
Setting the USB connection	191
Connecting to the computer	191
Importing images to the computer (Windows)	192
Importing images to the computer (Macintosh)	193
Deleting the USB connection	194
Creating a movie disc	195
Creating an AVCHD format disc	195
Creating a standard definition image quality (STD) disc	196
Discs you can use with “PMB”	197

Print

Specifying DPOF	198
Date Imprint	198

Cleaning

Cleaning the camera and a lens	199
Cleaning the image sensor	200

Trouble shooting/Others

Troubleshooting	203
Warning messages	212
Precautions	214
To use your camera abroad — Power sources	217
AVCHD format	218
GPS (SLT-A77V only)	219
3D-shootings	221
Memory card	222
Battery pack/Battery charger	224
The License	226
Checking the number of recordable images/recording time	227
Specifications	231
Index	239

Basic operations

This section provides the basic information on operating the camera. Read this section first. To more effectively take advantage of the camera, see “Advanced operations” (page 85).



Notes on using your camera

Shooting procedure

- This camera has 2 modes for monitoring subjects: the LCD monitor mode using the LCD monitor, and the viewfinder mode using the viewfinder.
- The recorded image may be different from the image you monitored before recording.

Notes on the functions available with the camera

- To check whether it is a 1080 60i-compatible device or 1080 50i-compatible device, check for the following marks on the bottom of the camera.
1080 60i-compatible device:60i
1080 50i-compatible device:50i
- This camera is compatible with 1080 60p or 50p-format movies. Unlike standard recording modes up to now, which record in an interlacing method, this camera records using a progressive method. This increases the resolution, and provides a smoother, more realistic image.
- You may feel uncomfortable symptoms such as eyestrain, nausea, or a tired feeling while watching 3D-images recorded with the camera on 3D-compatible monitors. When you watch 3D-images, we recommend that you take a break at regular time intervals. Since the need for or frequency of break times varies among individuals, please set your own standards. If you feel sick, stop watching 3D-images, and consult a doctor as needed. Also, refer to the operating instructions of the connected device or the software used with the camera. A child's vision is always vulnerable (especially for children under 6 years of age). Before allowing them to watch 3D-images, please consult with an expert, such as a pediatric or ophthalmic doctor. Be sure to make sure your children follow the precautions above.

No compensation for contents of the recording

The contents of the recording cannot be compensated for if recording or playback is not possible due to a malfunction of your camera or a memory card, etc.

Back up recommendation

To avoid the potential risk of data loss, always copy (back up) data to other medium.

Notes on the LCD monitor, electronic viewfinder, lens, and image sensor

- The LCD monitor and electronic viewfinder are manufactured using extremely high-precision technology so over 99.99% of the pixels are operational for effective use. However, there may be some tiny black points and/or bright points (white, red, blue or green in color) that constantly appear on the LCD monitor and electronic viewfinder. These points are normal in the manufacturing process and do not affect the images in any way.
- Do not hold the camera by taking hold of the LCD monitor.
- Do not expose the camera to sunlight or shoot sunward for a long time. The internal mechanism may be damaged. If sunlight is focused on a nearby object, it may cause a fire.
- There is a magnet on the back and around the rotating shaft of the hinge part of the LCD monitor. Do not bring anything that is easily affected by a magnet, such as floppy disk, credit cards near the LCD monitor.
- Images may trail across on the screen in a cold location. This is not a malfunction. When turning on the camera in a cold location, the screen may become temporarily dark. When the camera warms up, the screen will function normally.

Notes on long-time recording

- When you continue to shoot for a long time, the temperature of the camera rises. If the temperature reaches above a certain level, the [H] mark is indicated on the screen and the camera is turned off automatically. If the power is turned off, leave the camera for 10 minutes or longer to allow the temperature inside the camera to decrease to a safe level.
- Under high ambient temperatures, the temperature of the camera rises quickly.
- When the temperature of the camera rises, the image quality may deteriorate. It is recommended that you wait until the temperature of the camera drops before continuing to shoot.
- The surface of the camera may get warm. This is not a malfunction.

Notes on importing AVCHD View movies* to a computer

When importing AVCHD View movies to a computer, for Windows computers, use the "PMB" software on the CD-ROM (supplied).

* "AVCHD View movies" are movies that were recorded in the [AVCHD 60i/60p]/[AVCHD 50i/50p] mode of [File Format] (page 113).

Notes when playing movies on other devices

- This camera uses MPEG-4 AVC/H.264 High Profile for AVCHD format recording. Movies recorded in AVCHD format with this camera cannot be played with the following devices.
 - Other devices compatible with AVCHD format that does not support High Profile
 - Devices incompatible with the AVCHD format
- This camera also uses MPEG-4 AVC/H.264 Main Profile for MP4 format recording. For this reason, movies recorded in MP4 format with this camera cannot be played on devices other than those that support MPEG-4 AVC/H.264.
- Discs recorded with HD image quality (high definition) can be played back only

on AVCHD format-compatible devices. DVD-based players or recorders cannot play back HD image quality discs, as they are incompatible with the AVCHD format. Also, DVD-based players or recorders may fail to eject HD image quality discs.

- 1080 60p/50p movies can be played back on compatible devices only.

On GPS-compatible devices (SLT-A77V only)

- To determine whether your camera supports GPS function, check the model name of your camera.
GPS-compatible: SLT-A77V
GPS-incompatible: SLT-A77
- Use GPS in accordance with regulations of countries and regions where you use it.
- If you do not record the location information, set [GPS On/Off] to [Off] (page 169).
- In an airplane, make sure to turn off the camera following cabin announcements.

Warning on copyright

Television programs, films, videotapes, and other materials may be copyrighted. Unauthorized recording of such materials may be contrary to the provisions of the copyright laws.

The pictures used in this manual

The photographs used as examples of pictures in this manual are reproduced images, and are not actual images shot using this camera.

On the data specifications described in this manual

The data on performance and specifications is defined under the following conditions, except as described in this manual: at an ordinary ambient temperature of 25°C (77°F), and using a battery pack that is charged for about 1 hour after the CHARGE lamp goes out.

Model name

This manual covers several models supplied with different lenses. The model name varies depending on the supplied lens. The available model varies depending on the countries/regions.

Model name	Lens
SLT-A77/A77V	–
SLT-A77K/ A77VK	DT18-55mm
SLT-A77Q/ A77VQ	DT16-50mm
SLT-A77M/ A77VM	DT18-135mm

Notes on shooting with the viewfinder

This camera is equipped with an XGA Organic Electro-Luminescence viewfinder with high resolution and high contrast. This viewfinder achieves a wide viewing angle and a long eye relief, approaching that of the DSLR-A900 equipped with a 35 mm full size sensor. This camera is designed to provide an easily viewable viewfinder by appropriately balancing various elements.

- The image may be slightly distorted near the corners of the viewfinder. This is not a malfunction. When you want to check every detail of the entire composition, you can also use the LCD monitor.
- If you pan the camera while looking into the viewfinder or move your eyes around, the image in the viewfinder may be distorted or the color of the image may change. This is a characteristic of the lens or display device and is not a malfunction. When you shoot an image, we recommend that you look at the center area of the viewfinder.

Checking the supplied items

First check the model name of your camera (page 17). The accessories supplied differ depending on the model.

The number in parentheses indicates the number of pieces.

Common accessories

- Camera (1)
- BC-VM10A Battery charger (1)

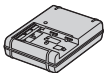

- Power cord (mains lead) (1)* (not supplied in the U.S.A. and Canada)



* Multiple power cords may be supplied with your camera. Use the appropriate one that matches your country/region.

- Rechargeable battery pack NP-FM500H (1)



- USB cable (1)



- Shoulder strap (1)

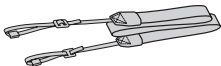

- Body cap (1) (Attached on the camera)



- Accessory shoe cap (1) (Attached on the camera)
- Eyecup (1) (Attached on the camera)
- CD-ROM (1)
 - Application Software for α camera
- Instruction Manual (1) (This manual)

SLT-A77K/A77VK

- DT18-55mm zoom lens (1)/Front lens cap (1)/Rear lens cap (1)

SLT-A77Q/A77VQ

- DT16-50mm zoom lens (1)/Front lens cap (1)/Rear lens cap (1)/Lens hood (1)

SLT-A77M/A77VM

- DT18-135mm zoom lens (1)/Front lens cap (1)/Rear lens cap (1)/Lens hood (1)

Identifying parts

See the pages in parentheses for details of operation.

Front side

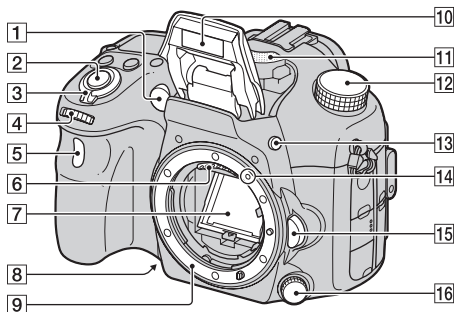

- 1 AF illuminator (120)/Self-timer lamp (155)
- 2 Shutter button (36)
- 3 Power switch (33)
- 4 Front control dial (102)
- 5 Remote sensor (158)
- 6 Lens contacts*
- 7 Mirror*
- 8 Preview button (105)
- 9 Mount
- 10 Built-in flash* (47, 135)
- 11 Microphone** (115)





- 12 Mode dial (42)
- 13  (Flash pop-up) button (47, 135)
- 14 Mounting index (30)
- 15 Lens release button (31)
- 16 Focus mode dial (116, 123)

* **Do not directly touch these parts.**

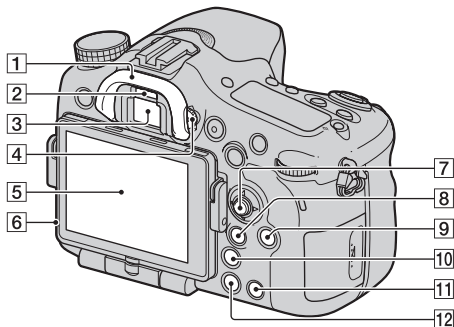
** **Do not cover this part during movie recording. Doing so may cause noise or lower the volume.**





Rear side

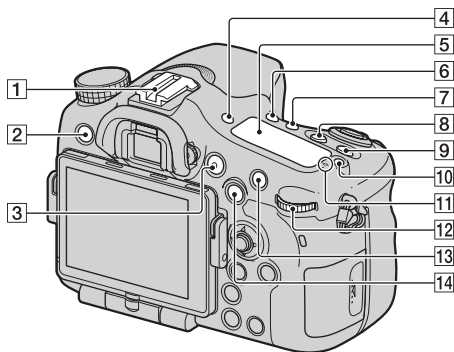

- 1** Eyecup (86)
- 2** Eyepiece sensors (86)
- 3** Viewfinder*
- When you look into the viewfinder, the viewfinder mode is activated, and when you take your face away from the viewfinder, the screen mode returns to the LCD monitor mode.
- 4** Diopter-adjustment dial (35)
- 5** LCD monitor (79, 90, 159)
- 6** Light sensor (178)
- 7** Multi-selector
- 8** For shooting: Fn (Function) button (59, 60)
For viewing:  (Image rotation) button (161)
- 9** DISP (Display) button (87, 159)
- 10**  (Smart teleconverter) button (153)/Focus Magnifier button (124)
- 11** ? (In-Camera Guide) button (70)
For viewing:  (Delete) button (40)
- 12**  (Playback) button (39)
- * **Do not directly touch this part.**

Top side



- 1 Auto-lock Accessory shoe (135)
- 2 MENU button (62)
- 3 MOVIE button (38, 111)
- 4 FINDER/LCD button (179)
- 5 Display panel (93)
- 6  (Drive) button (51, 154)
- 7 WB (White balance) button (148)
- 8  (Exposure) button (49)
- 9 ISO button (139)
- 10 Display panel illumination button (93)
- 11  Image sensor position mark (118)
- 12 Rear control dial
- 13 For shooting: AF/MF (Auto focus/manual focus) button (126)
For viewing:  (Enlarge) button (55)
- 14 For shooting: AEL (AE lock) button (131)/SLOW SYNC button (136)
For viewing:  (Image index) button (56)

Sides/Bottom

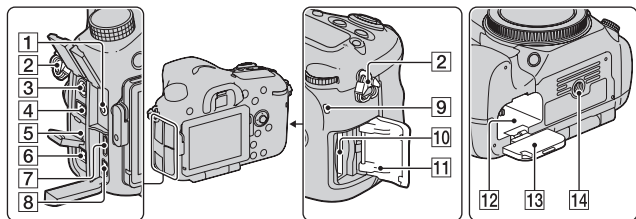
**1** Microphone jack

- When an external microphone is connected, the internal microphone is turned off automatically. When the external microphone is a plug-in-power type, the power of the microphone is supplied by the camera.

2 Hooks for shoulder strap

- Attach both ends of the strap onto the camera.

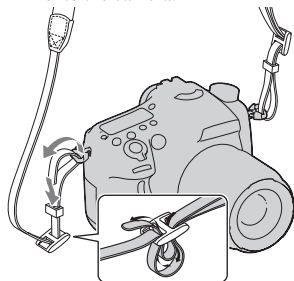
**3** ⚡ (Flash sync) terminal (137)**4** REMOTE terminal

- When connecting the RM-L1AM Remote Commander (sold separately) to the camera, insert the plug of the Remote Commander into the REMOTE terminal, aligning the guide of the plug with the guide of the REMOTE terminal. Make sure that the cord of the Remote Commander faces forward.

5 Speaker**6** DC IN terminal

- When connecting the AC-PW10AM AC Adaptor (sold separately) to the camera, turn the camera off, then plug the connector of the AC Adaptor to the DC IN terminal on the camera.

7 HDMI terminal (57, 167)**8** ↔ (USB) terminal (191)**9** Access lamp (28)

- 10 Memory card insertion slot (27)
- 11 Memory card cover (27)
- 12 Battery insertion slot (27)
- 13 Battery cover (27)
- 14 Tripod receptacle

- Use a tripod with a screw length of less than 5.5 mm (7/32 inch). You will be unable to firmly secure the camera to tripods with a screw length of 5.5 mm (7/32 inch) or longer, and attempting to do so may damage the camera.

Lens

DT 18-55mm F3.5-5.6 SAM
(Supplied with the SLT-A77K/A77VK)

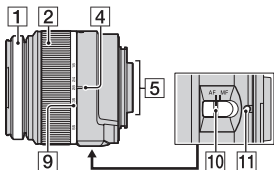

DT 16-50mm F2.8 SSM
(Supplied with the SLT-A77Q/A77VQ)

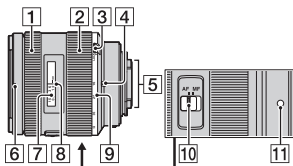

DT 18-135mm F3.5-5.6 SAM
(Supplied with the SLT-A77M/A77VM)

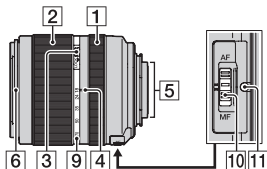

- 1 Focusing ring
- 2 Zoom ring
- 3 Zoom lock switch
- 4 Focal-length index

- 5 Lens contacts
- 6 Lens hood index
- 7 Distance scale
- 8 Distance index
- 9 Focal-length scale
- 10 Focusing mode switch
- 11 Mounting index

- The DT 18-55mm F3.5-5.6 SAM/DT 16-50mm F2.8 SSM/DT 18-135mm F3.5-5.6 SAM are designed for Sony A-mount cameras (models equipped with an APS-C sized image sensor). You cannot use these lenses on 35mm-format cameras.
- For the lenses other than DT 18-55mm F3.5-5.6 SAM/DT 16-50mm F2.8 SSM/DT 18-135mm F3.5-5.6 SAM, refer to the operating instructions supplied with the lens.

Charging the battery pack

When using the camera for the first time, be sure to charge the NP-FM500H “InfoLITHIUM” battery pack (supplied).

The “InfoLITHIUM” battery pack can be charged even when it has not been fully depleted.

It can also be used when it has not been fully charged.

The battery pack is discharged little by little without using it. To miss the opportunity to shoot, check the remaining battery level before use. If the battery level is low, charge it again.

1 Insert the battery pack onto the battery charger.

Push the battery pack until it clicks.

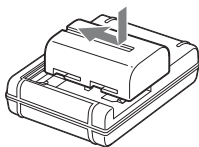

2 Connect the battery charger to the wall outlet (wall socket).

Light on: Charging

Light off: Charge completed

Charging time	About 175 minutes
---------------	-------------------

- When charging a fully depleted battery pack at a temperature of 25°C (77°F).
- The CHARGE lamp turns off when charging is completed.

For the U.S.A and Canada

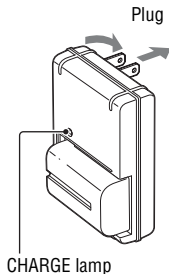

For countries/regions other than the U.S.A. and Canada

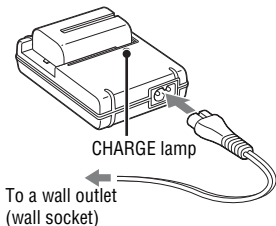

Notes

- The charging time differs depending on the remaining capacity of the battery pack or charging conditions.
- We recommend charging the battery pack in an ambient temperature of between 10°C to 30°C (50°F to 86°F). You may not be able to efficiently charge the battery pack outside of this temperature range.
- Connect the battery charger to the nearest wall outlet (wall socket).

Inserting the battery pack/memory card (sold separately)

- 1** While sliding the battery cover open lever, open the cover.

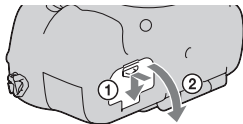

- 2** Firmly insert the battery pack all the way while pressing the lock lever with the tip of the battery.

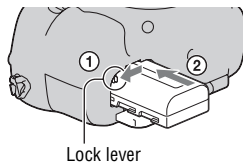

- 3** Close the cover.

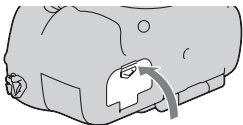

- 4** While sliding the memory card cover, open the cover.

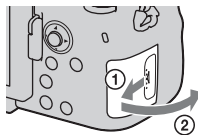

5 Insert a memory card.

- With the notched corner facing as illustrated, insert the memory card until it clicks into place.

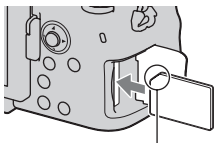

Ensure the notched corner faces correctly.

6 Close the cover.

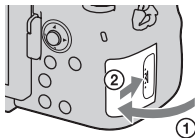

To remove the battery pack

Turn off the camera and slide the lock lever in the direction of the arrow. Be careful not to drop the battery pack.

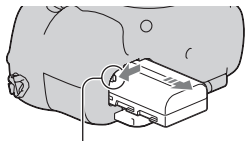

Lock lever

To remove the memory card

Check that the access lamp is not lit, then open the cover, and push the memory card once.

To check the remaining battery level

The supplied battery pack is a lithium-ion battery pack that has functions for exchanging information related to operating conditions with your camera. The remaining battery time in percent figures is displayed according to the operating conditions of your camera.

Battery level						“Battery exhausted.”
	High Low					You cannot shoot any more pictures.

Available memory cards

The following memory cards are compatible with this camera. However, all memory cards are not guaranteed to work with this camera.

Types of memory card	Still images	Movies	In this manual
Memory Stick PRO Duo	✓	✓ (Mark2)	Memory Stick PRO Duo
Memory Stick PRO-HG Duo	✓	✓	
SD memory card	✓	✓ (Class 4 or faster)	SD card
SDHC memory card	✓	✓ (Class 4 or faster)	
SDXC memory card	✓	✓ (Class 4 or faster)	

- MultiMediaCard cannot be used.

Note

- Images recorded on an SDXC memory card cannot be imported to or played on computers or AV devices that are not compatible with exFAT. Make sure that the device is compatible with exFAT before connecting it to the camera. If you connect your camera to an incompatible device, you may be prompted to format the card. Never format the card in response to this prompt, as doing so will erase all data on the card. (exFAT is the file system used on SDXC memory cards.)

Attaching a lens

1 Remove the body cap from the camera and the rear lens cap from the rear of the lens.

- When changing the lens, quickly change the lens away from dusty locations so as to keep dust or debris from getting inside the camera.
- When shooting, remove the front lens cap from the front of the lens.

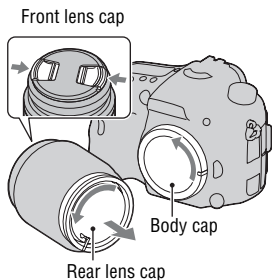

2 Mount the lens by aligning the orange index marks (mounting indexes) on the lens and camera.

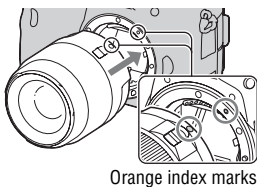

3 Turn the lens clockwise until it clicks into the locked position.

- Be sure to put the lens on straight.

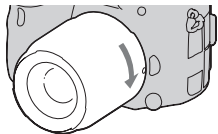

Notes

- When attaching a lens, do not press the lens release button.
- Do not use force when attaching a lens.
- E-mount lenses are not compatible with this camera.
- When you use a lens for which a tripod socket is provided, attach the lens onto the tripod using the tripod socket provided to help balance the weight of the lens.
- When carrying the camera with a lens attached, hold both the camera and the lens firmly.

- Do not hold the part of the lens that is extended for the zoom or focus adjustment.

To remove the lens

- 1 Press the lens release button all the way in and turn the lens counterclockwise until it stops.**

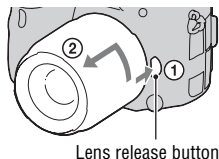

- 2 Attach the caps to the front and rear of the lens and the body cap to the camera.**

- Before you attach them, remove dust from them.

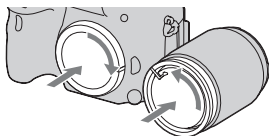

To attach a lens hood

It is recommended that you use a lens hood to reduce flare and ensure maximum image quality.

Fit the hood into the mount on the end of the lens barrel and rotate the hood clockwise until it clicks.

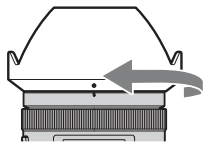

Notes

- Attach the lens hood properly. Otherwise, the lens hood may interfere with the desired effect or may appear on your images.
- When the lens hood is properly attached to the DT 16-50mm F2.8 SSM, the red dot on the lens lines up with the red dot on the hood.
- A lens hood is not included with the DT 18-55mm F3.5-5.6 SAM. You can use the ALC-SH108 (sold separately).
- The lens hood may block the light of the flash. Remove the lens hood when using the flash.

- When storing, turn over the lens hood and place it onto the lens backwards.

Note on changing the lens

When changing the lens, if dust or debris gets inside the camera and adheres to the surface of the image sensor (the part that acts as the film), it may appear as dark spots on the image, depending on the shooting environment.

The camera is equipped with an anti-dust function to prevent dust from landing on the image sensor. However, quickly change the lens away from dusty locations when attaching/removing a lens.

Turning the camera on and setting the clock

When you turn the camera on for the first time, the date/time setup screen appears.

1 Set the power switch to ON to turn the camera on.

The screen used for setting date and time appears.

- To turn the camera off, set it to OFF.

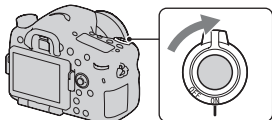

2 Verify that [Enter] is selected on the LCD monitor, then press the center of the multi-selector.

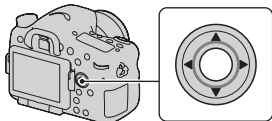

3 Select your area with ◀/▶ on the multi-selector, then press the center of the multi-selector.

4 Select each item with ◀/▶ and set the numeric value with ▲/▼.

[Daylight Svg.]: Turns on or off the daylight saving time setting.

[Date Format.]: Selects the format to display date.

- Midnight is indicated as 12:00 AM, and noon as 12:00 PM.

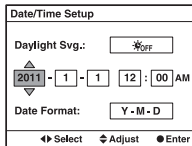
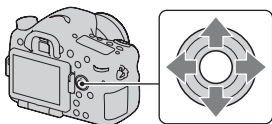

5 Repeat step 4 to set other items, then press the center of the multi-selector.

6 Verify that [Enter] is selected, then press the center of the multi-selector.

To cancel the date/time setting operation

Press the MENU button.

To set up the date/time again

When you turn the camera on for the first time, the date/time setup screen appears automatically. The next time, set up the date and time from the menu.

MENU button →  1 → [Date/Time Setup]

To set up the area again

You can set the area where you are using the camera. This allows you to set the local area when you use the camera abroad.

MENU button →  1 → [Area Setting]

Maintaining the date and time setting

This camera has an internal rechargeable battery for maintaining the date and time and other settings regardless of whether the power is on or off, or the battery is installed or not (page 214).

Before shooting

Adjusting the viewfinder to the visual acuity (diopter adjustment)

Adjust the diopter-adjustment dial to your eyesight until the display appears clearly in the viewfinder.

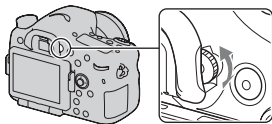

Note

- The dioptic adjustment attachment (sold separately) cannot be used with this camera.

Holding the camera properly

Stabilize your upper body and take a position that keeps the camera from moving.

In LCD monitor mode



In viewfinder mode



In viewfinder mode
(vertical position)



Point ①

One hand holds the grip of the camera, and the other hand supports the lens.

Point ②

Take a secure stance with your feet shoulder-width apart.

Point ③

Lightly tuck your elbows against your body.

When shooting in a kneeling position, steady your upper body by placing your elbow on your knee.

Shooting still images

The “AUTO” mode allows you to easily shoot any subject under any conditions because the camera makes appropriate judgments on the situation to adjust the settings.

1 Set the mode dial to **AUTO**.

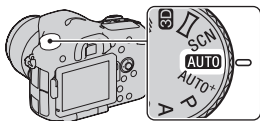

2 Hold the camera, monitoring your shot with the LCD monitor or viewfinder.

3 Overlay the AF area on the desired subject.

- If the  (Camera shake warning) indicator flashes, carefully shoot the subject, holding the camera steady, or by using a tripod.

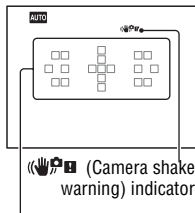

4 When using a zoom lens, turn the zoom ring, then decide on your shot.

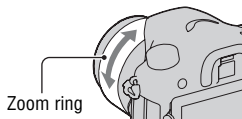

5 Press the shutter button halfway down to focus.

When the focus is confirmed, ● or (Focus indicator) lights up (page 118).

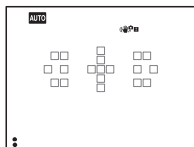
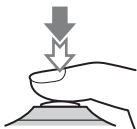

Focus indicator

6 Press the shutter button fully down to shoot.

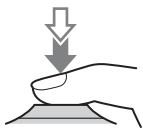

Recording movies

1 Press the MOVIE button to start recording.

- Movie recording can be started from any exposure mode.
- The shutter speed and aperture are adjusted automatically. If you want to set them to particular values, set the mode dial to  (Movie) (page 112).
- The camera continues to adjust the focus when it is in autofocus mode.

MOVIE button



2 Press the MOVIE button again to stop recording.

Notes

- The sound of the camera and the lens in operation may be recorded while recording a movie. You can disable sound recording by setting [Audio Recording] to [Off] (page 115).
- The continuous recording time of a movie may be shorter, depending on the ambient temperature or the status of the camera. See “Notes on continuous movie recording.”
- When the  mark is indicated, the temperature of the camera is too high. Turn the camera off and wait until the temperature of the camera drops (page 213).

Playing back images

1 Press the  button.

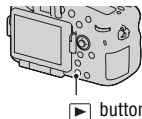

2 MENU button →  1 → [View Mode] → Select the desired mode

- To play back still images, select [Folder View(Still)], and to play back movies, select [Folder View(MP4)] or [AVCHD View] according to the file format.

3 Select an image with  on the multi-selector.

- To play back movies, press the center of the multi-selector.

During movie playback	Multi-selector/Front or rear control dial operation
To pause/resume	●
To fast-forward	▶
To fast-rewind	◀
To slow-forward	Rotate the front or rear control dial to the right during pause.
To slow-reverse	Rotate the front or rear control dial to the left during pause. <ul style="list-style-type: none">• The movie is played back frame-by-frame.
To adjust sound volume	▼ → ▲/▼
To display the information	DISP (Display) button

Note

- Movies recorded with other devices may not be played back on this camera.

Deleting images (Delete)

Once you have deleted an image, you cannot restore it. Check whether to delete the image or not beforehand.

Note

- Protected images cannot be deleted.

Deleting the image that is currently displayed

- 1** Display the image you want to delete and press the  button.

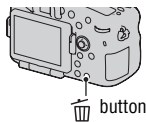

- 2** Select [Delete] with **▲** on the multi-selector, then press the center of the multi-selector.

Adjusting the angle of the LCD monitor

Adjust the LCD monitor to an easily viewable angle.

- Put your finger on the upper-left part of the LCD monitor and draw it toward you.
- The LCD monitor tilts 150 degrees upward and 180 degrees downward.
- The LCD monitor rotates 180 degrees clockwise and 90 degrees counterclockwise.
- When the LCD monitor is not used, it is recommended that you close it with the screen side facing to the camera.

Note

- When the LCD monitor is open, the eye sensor may not be able to function in situations involving low-position shooting. If you look into the viewfinder and the monitor is not switched automatically, press the FINDER/LCD button.

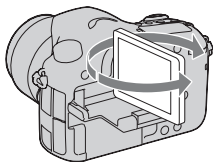
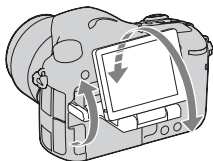
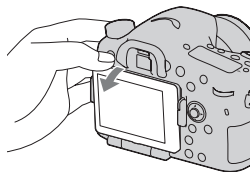



Shooting images to suit your subject

Shooting with the various shooting modes

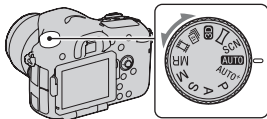
Set the mode dial to the desired mode.



The following shooting modes are provided with the camera:

AUTO (AUTO) (36, 96)	Allows you to easily shoot any subject under any conditions because the camera makes appropriate judgments on the situation to adjust the settings.
AUTO+ (Auto+) (43, 96)	The camera recognizes and evaluates the shooting condition, and appropriate settings are set automatically. The camera saves 1 appropriate image by combining or separating images, as necessary.
SCN (Scene Selection) (44, 97)	Selecting an appropriate mode for the subject or the shooting conditions allows you to shoot the image with a suitable setting for the subject.
 (Sweep Panorama) (45, 99)	Allows you to shoot panoramic images.
3D (3D Sweep Panorama) (45, 99)	Allows you to shoot 3D panoramic images for playback on a 3D compatible TV.
 (Cont. Priority AE) (46, 101)	The camera continues to shoot while the shutter button is pressed fully down. The camera records the images continuously at a maximum of about 12 images per second.
 (Movie) (38, 111)	Allows you to shoot movies with the exposure adjusted manually (both the shutter speed and the aperture value).
P (Program Auto) (102)	Allows you to shoot with the exposure adjusted automatically (both the shutter speed and the aperture value). The other settings can be adjusted manually.
A (Aperture Priority) (103)	Allows you to shoot after adjusting the aperture value manually using the front or rear control dial.
S (Shutter Priority) (105)	Allows you to shoot after adjusting the shutter speed manually using the front or rear control dial.

M (Manual Exposure) (107)	Allows you to shoot after adjusting the exposure manually (both the shutter speed and the aperture value) using the front or rear control dial.
MR (Memory recall) (185)	Calls up setting pre-registered in [Memory] in the  Still shooting menu.

AUTO⁺**1 Set the mode dial to AUTO⁺ (Auto+).****2 Point the camera towards the subject.**





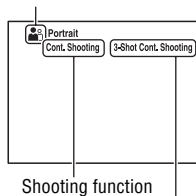







When the camera recognizes and adjusts for shooting conditions, the following information is indicated: recognized scene mode mark, appropriate shooting function, the number of images to be shot.

Recognized scene mode mark



Number of images to be shot

3 Adjust the focus and shoot the subject.**Scene recognized by the camera**









 (Night Scene)	 (Hand-held Twilight)	 (Landscape)
 (Backlight Portrait)	 (Portrait)	 (Tripod Night Scene)
 (Backlight)	 (Macro)	 (Night Portrait)
 (Spotlight)	 (Low Brightness)	 (Baby)

Shooting function

Cont. Shooting (154)	Slow Sync. (135)	Auto HDR (142)
Daylight Sync.	Slow Shutter	Hand-held Twilight (44, 97)

SCN Scene Selection

- 1 Set the mode dial to SCN (Scene Selection).**
- 2 Select the desired mode with ▲/▼, then press the center of the multi-selector.**
 - To change the scene, press the Fn button, then select another scene.
- 3 Adjust the focus and shoot the subject.**

 (Portrait)	Blurs away backgrounds and sharpens the subject. Expresses skin tones softly.
 (Sports Action)	Shoots a moving subject at a fast shutter speed so that the subject looks as if it is standing still. The camera shoots images continuously while the shutter button is pressed.
 (Macro)	Shoots close subjects such as flowers, foods.
 (Landscape)	Shoots the entire range of scenery in sharp focus with vivid colors.
 (Sunset)	Shoots the red of the sunrise or sunset beautifully.
 (Night Scene)	Shoots night scenes at a distance without losing the dark atmosphere of the surroundings.
 (Hand-held Twilight)	Shoots night scenes with less noise and blur without using a tripod. A burst of shots are taken, and image processing is applied to reduce subject blur, camera shake, and noise.
 (Night Portrait)	Shoots portraits in night scenes.

☐ Sweep Panorama/3D 3D Sweep Panorama

1 Set the mode dial to ☐ (Sweep Panorama)/3D (3D Sweep Panorama).

2 Point the camera at the edge of the subject, then press the shutter button halfway down to adjust the focus.

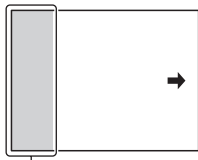

This part will not be taken

3 Press the shutter button fully down.

4 Pan or tilt the camera to the end, following the guidance on the screen.

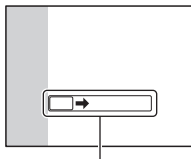

Guidance bar

Shooting images to suit your subject

 Continuous Advance Priority AE

1 Set the mode dial to  (Cont. Priority AE).

2 Adjust the focus and shoot the subjects.

- The camera continues to shoot while the shutter button is pressed fully down.
 - The camera records the images continuously at a maximum of about 12 images per second.
-

Using the flash

In a dark location, using the flash allows you to shoot the subject brightly, and it also helps to prevent camera shake. When shooting into the sun, you can use the flash to shoot a bright image of the backlit subject.

1 Fn button → ⚡ (Flash Mode) → Select the desired setting

- For further information on the flash modes available for each shooting mode, see page 83.

2 Press the ⚡ button.

The flash pops up.

- In AUTO, AUTO+ or Scene Selection mode, the flash automatically pops up if the amount of light is insufficient or the subject is backlit. The built-in flash does not pop up even if you press the ⚡ button.

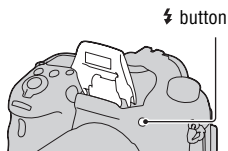



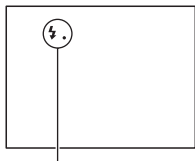

3 After the flash has finished charging, shoot the subject.

⚡● Flashing: The flash is being charged. When the indicator flashes, you cannot release the shutter.

⚡● Lit: The flash has been charged and is ready to fire.



⚡● (Flash charging) indicator

 (Flash Off)	Does not fire even the built-in flash pops up. <ul style="list-style-type: none">• You cannot select this item when the mode dial is set to P, A, S, or M. However, the flash will not be fired if it is not pulled up.
 (Autoflash)	Fires if it is dark or against light.
 (Fill-flash)	Fires every time you trigger the shutter.
 (Rear Sync.)	Fires right before the exposure is completed every time you trigger the shutter.
 (Wireless)	Fires an external flash (sold separately) that is off the camera and away from it (Wireless flash shooting).

Adjusting the brightness of the image

Except for exposure mode M, the exposure is automatically selected (Automatic exposure).

Based on the exposure acquired by the automatic exposure, you can perform exposure compensation. You can make the entire image brighter by shifting to the + side. The entire image becomes darker when you shift it to the - side (Exposure compensation).

1 Press the button.

 button



2 Adjust the exposure with / on the multi-selector.

Toward + (over): Brightens an image.

Toward - (under): Darkens an image.

- In viewfinder mode, confirm the exposure using the EV scale.

LCD monitor

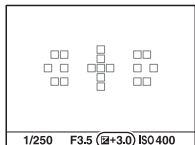

Compensated exposure

Viewfinder



Standard exposure

3 Adjust the focus and shoot the subject.

Shooting techniques

- Adjust the compensation level by checking the recorded image.
- Using bracket shooting, you can shoot multiple images with the exposure shifted to the plus or minus sides (page 155).

Note

- This item cannot be set when the exposure mode is set to AUTO, AUTO+, or Scene Selection.

To compensate the exposure with the front or rear control dial



MENU button →  4 → [Dial exp.comp] → Select the desired setting

Note

- If you assign the exposure compensation function to the front or rear control dial, the originally-assigned function can be operated with the other control dial.





/ **Selecting the drive mode**

You can use an appropriate drive mode to suit your purposes, such as single-shot advanced, continuous advanced, or bracket.

 /  **button** → **Select the desired mode**

 /  **button**



 (Single Shooting) (154)	This mode is for normal shooting.
 (Cont. Shooting) (154)	The camera records the images continuously.
 (Self-timer) (155)	The 10-second self-timer is convenient when the photographer appears in a photo and the 2-second self-timer is convenient to reduce the camera shake.
BRK C (Bracket: Cont.) (155)	You can shoot the specified number of images, each with different degrees of exposure.
BRK S (Single Bracket) (155)	You can shoot the specified number of images, shot by shot, each with different degrees of exposure.
BRK WB (WB bracket) (157)	Based on the selected white balance, and the color temperature/color filter, 3 images are recorded with the white balance shifted.
BRK DRO (DRO Bracket) (158)	You can shoot 3 images with the value of D-Range Optimizer shifted.
 (Remote Cdr.) (158)	You can shoot using the SHUTTER and 2SEC (the shutter is released after 2 seconds) buttons on the RMT-DSLR1 Wireless Remote Commander (sold separately).

Switching the recording information display (DISP)

Each time you press the DISP button, the recording information display changes as follows.

You can select the available displays in the viewfinder or on the LCD monitor separately.



DISP button

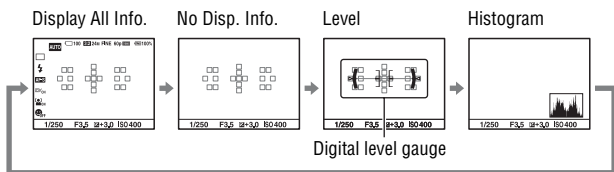

Setting image size

Image Size

MENU button →  1 → [Image Size] → Select the desired size

[Aspect Ratio]: [3:2]

Image size		Usage guidelines
L:24M	6000 × 4000 pixels	For shooting at the highest image quality
M:12M	4240 × 2832 pixels	For prints up to A3+ size
S:6.0M	3008 × 2000 pixels	For prints up to A5 size

[Aspect Ratio]: [16:9]

Image size		Usage guidelines
L:20M	6000 × 3376 pixels	For viewing on a high-definition TV
M:10M	4240 × 2400 pixels	
S:5.1M	3008 × 1688 pixels	

Note

- When you select a RAW image with [Quality], the image size of the RAW image corresponds to L. This size is not displayed on the screen.

Panorama: Size

You can set the image size of panoramic images. The image size varies depending on the setting of the shooting direction (page 101).

MENU button →  1 → [Panorama: Size] or [3D Pan.: Image Size] → Select the desired size

[Panorama: Size]

Standard	[Panorama: Direction] is set to [Up] [Down]: 3872 × 2160 [Panorama: Direction] is set to [Right] [Left]: 8192 × 1856
Wide	[Panorama: Direction] is set to [Up] [Down]: 5536 × 2160 [Panorama: Direction] is set to [Right] [Left]: 12416 × 1856

[3D Pan.: Image Size]

16:9	1920 × 1080
Standard	4912 × 1080
Wide	7152 × 1080

Enlarging images

A still image can be enlarged for closer examination. This is convenient to check the focus condition of a recorded image.

- 1 Display the image you want to enlarge, then press the  button.**

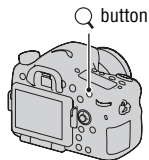

- 2 Zoom the image in or out with the rear control dial.**

- Rotating the front control dial switches the image at the same display magnification. When you shoot multiple images with the same composition, you can compare their focus conditions.

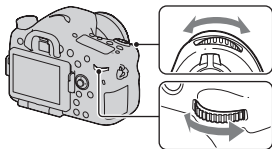

- 3 Select the portion you want to enlarge with , , , or  on the multi-selector.**

To cancel the enlarged playback

Press the center of the multi-selector so that the image returns to the normal size.

Switching to the display of the image list

You can display multiple images on the screen simultaneously.

Press the button.

The image index screen is displayed.

- You can select the number of images displayed on one page of the image index screen by pressing the DISP button.

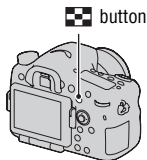

To return to the single-image screen

Press the center of the multi-selector when you select the desired image.

To display the desired folder

Select the left bar on the image index screen with the multi-selector, then select the desired folder with ▲/▼. Pressing the center of the multi-selector when the left bar is selected switches the view mode.



Viewing images on a TV screen

To view images recorded on the camera on a TV set, an HDMI cable (sold separately) and an HD TV equipped with an HDMI connector are required.

1 Turn off both your camera and the TV, and connect the camera to the TV.

① To the HDMI connector

HDMI cable
(sold separately)

② To the
HDMI terminal

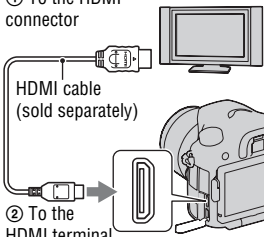



2 Turn on the TV and switch the input.

- See also the operating instructions supplied with the TV.

3 Turn on the camera, and press the button.

Images shot with the camera appear on the TV screen.





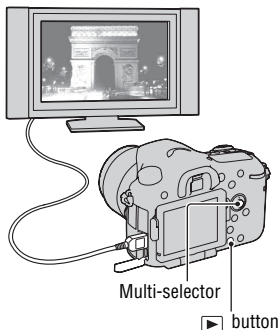



Select the desired image with   on the multi-selector.

- The LCD monitor on the camera does not turned on.



Functions that can be operated with the buttons/dial

You can set up or operate various functions with these buttons/dial.
For the location of the buttons/dial, see “Identifying parts” (page 19).

 button (47, 135)	Pops the flash up.
 button (51, 154)	Selects the drive mode.
WB button (148)	Adjusts the white balance.
 button (49)	Compensates the exposure.
ISO button (139)	Adjusts the ISO sensitivity.
FINDER/LCD button (179)	Switches the display between the LCD monitor and the viewfinder.
Display panel illumination button (93)	Turns on the backlight of the display panel.
MENU button (62)	Displays the menu screen for setting up the menu item.
MOVIE button (38, 111)	Records movies.
AEL button (131)/SLOW SYNC button (136)/ button (56)	Fixes the exposure of the entire screen./Shoots with the flash with a slower shutter speed./Displays multiple images on the screen simultaneously.
AF/MF button (126)/ button (55)	Switches the autofocus and manual focus temporarily./Scales an image up when viewing images.
Fn button (59, 60)/ button (161)	Displays the setup screen of the function that is set using the Fn button./Rotates images.
 button (153)/ Focus Magnifier button (124)	Zooms in to the center of an image./Allows you to check the focus by enlarging the image before shooting.
 button (39)	Plays back images.
? button (70)/ button (40)	Displays a In-Camera Guide./Deletes images.
Focus mode dial (116, 123)	Switches the autofocus and manual focus.
Preview button (105)	Checks blurring of the background.

Selecting a function with the Fn (Function) button

This button is used for setting up or executing functions used frequently in shooting.

1 Press the Fn button.

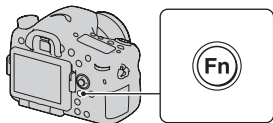

2 Select the desired item with ▲/▼/◀/▶ on the multi-selector, then press the center ● to execute.

The setup screen appears.

3 Following the operation guide, select and execute the desired function.

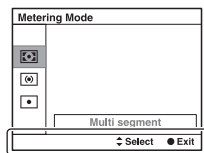

Operation guide

To set up the camera directly from the recording information screen

Turn the front control dial without pressing the center ● in step 2. You can set up the camera directly from the recording information screen (except for [Memory recall]). Additionally, some functions can be fine-tuned using the rear control dial.

Functions that can be selected with the Fn (Function) button

The functions that can be selected with the Fn button are as follows:

Scene Selection (44, 97)	Selects an appropriate mode from among the Scene Selection preset settings to suit shooting conditions. (Portrait/Sports Action/Macro/Landscape/Sunset/Night Scene/Hand-held Twilight/Night Portrait)
Movie (112)	Selects the exposure mode to suit your subject or your effect. (P/A/S/M)
Memory recall (185)	Calls up setting pre-registered in [Memory] in the  Still shooting menu. (Memory1/Memory2/Memory3)
Drive Mode (51, 154)	Sets the drive mode such as continuous shooting. (Single Shooting/Cont. Shooting/Self-timer/Bracket: Cont./Single Bracket/WB bracket/DRO Bracket/Remote Cdr.)
Flash Mode (47, 135)	Sets the flash mode. (Flash Off/Autoflash/Fill-flash/Rear Sync./Wireless)
AF area (119)	Selects the area of focus. (Wide/Zone/Spot/Local)
Object Tracking (121)	Keeps the focus on a subject while tracking it. (On/Off)
Face Detection (127)	Automatically captures people's face(s) with the optimal focus and exposure. (On/On (Regist. Faces)/Off)
Smile Shutter (129)	Shoots when a smile is detected. (On/Off)
ISO (139)	Sets the sensitivity to light. The larger the number, the faster the shutter speed. (Multi Frame Noise Reduct./ISO AUTO to 16000)
Metering Mode (132)	Selects the method for measuring brightness. (Multi segment/Center weighted/Spot)
Flash Comp. (132)	Adjusts the intensity of flash output. (+3.0EV to -3.0EV)
White Balance (148)	Adjusts the color tone of images. (Auto WB/Daylight/Shade/Cloudy/Incandescent/Fluor.: Warm White/Fluor.: Cool White/Fluor.: Day White/Fluor.: Daylight/Flash/Color Temp./Color Filter/Custom)

DRO/Auto HDR (141)	Compensates for the brightness and contrast automatically. (Off/D-Range Opt./Auto HDR)
Creative Style (145)	Selects your desired image processing. (Style Box1-6)
Picture Effect (144)	Shoots with the desired effect filter to achieve more impressive expression. (Off/Toy Camera/Pop Color/Posterization/Retro Photo/Soft High-key/Partial Color/High Contrast Mono./Soft Focus/HDR Painting/Rich-tone Mono./Miniature)

The functions selected with the MENU button

You can set up the basic settings for the camera as a whole or execute functions such as shooting, playback, or other operations.

Press the MENU button, then set up the desired item with ▲/▼/◀/▶ on the multi-selector, then press the center of the multi-selector.

Select a page of the menu

Select an item on the menu



Still shooting menu

Image Size (53)	Selects the size of still images. (L:24M/M:12M/S:6.0M (When [Aspect Ratio] is set to 3:2) L:20M/M:10M/S:5.1M (When [Aspect Ratio] is set to 16:9))
Aspect Ratio (172)	Selects the aspect ratio for still images. (3:2/16:9)
Quality (172)	Sets the image quality for still images. (RAW/RAW & JPEG/Extra fine/Fine/Standard)
Panorama: Size (53)	Selects the size of panoramic images. (Standard/Wide)
Panorama: Direction (101)	Sets the shooting direction for panoramic images. (Right/Left/Up/Down)
3D Pan.: Image Size (53)	Selects the size of 3D-images. (16:9/Standard/Wide)
3D Pan.: Direction (101)	Sets the shooting direction for 3D-images. (Right/Left)

Long Exposure NR (174)	Sets noise reduction processing for shots in which shutter speed will be 1 second or longer. (On/Off)

High ISO NR (174)	Sets noise reduction processing for high-sensitivity shooting. (High/Normal/Low)
Flash control (133)	Sets the method for determining the intensity of flash output. (ADI flash/Pre-flash TTL/Manual flash)
Power ratio (134)	Sets the amount of built-in flash light when [Flash control] is set to [Manual flash]. (1/1–1/6)
AF Illuminator (120)	Sets the AF illuminator, which sheds light on a dark scene to aid focusing. (Auto/Off)
Color Space (175)	Changes the range of reproducible colors. (sRGB/AdobeRGB)
SteadyShot (94)	Sets SteadyShot. (On/Off)



Exposure step	Selects the size of the increment step for shutter speed, aperture, and exposure. (0.5 EV/0.3 EV)
AF-A setup (125)	Sets whether or not to fine-tune the focus manually when the focus mode is set to [AF-A]. (AF-A/DMF)
Priority setup	Sets whether or not to release the shutter even when the focus is not confirmed in autofocus mode. (AF/Release)
AF w/ shutter	Sets whether or not to activate the autofocus by pressing the shutter button halfway down. (On/Off)
Memory (185)	Registers combinations of frequently used modes and settings and allows easy recall of those combinations with the mode dial. (1/2/3)

Movie shooting menu



File Format (113)	Selects the movie file format. (AVCHD 60i/60p/AVCHD 50i/50p/MP4)
--------------------------	--

Record Setting (114)	Selects the size of the recorded movie frame. (60i 24M(FX)/50i 24M(FX)/60i 17M(FH)/50i 17M(FH)/60p 28M(PS)/50p 28M(PS)/24p 24M(FX)/25p 24M(FX)/24p 17M(FH)/25p 17M(FH)/1440×1080 12M/VGA 3M)
Audio Recording (115)	Sets whether or not to record audio when shooting a movie. (On/Off)
Wind Noise Reduct. (115)	Reduces wind noise during movie recording. (On/Off)
SteadyShot (94)	Sets SteadyShot. (On/Off)

Custom menu

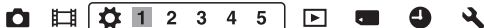

Eye-Start AF (86)	Sets whether or not to use auto focus when you look through the viewfinder. (On/Off)
FINDER/LCD Setting (179)	Sets the method for switching between the viewfinder and LCD monitor. (Auto/Manual)
Red Eye Reduction	Reduces the red-eye phenomenon during flash use. (On/Off)
Release w/o Lens (175)	Sets whether shutter can open when lens is not attached. (Enable/Disable)
Auto+ Cont. Shooting (96)	Sets whether or not to shoot continuously in AUTO+ mode. (Auto/Off)
Auto+ Image Extract. (96)	Sets whether or not to save all the images that were shot continuously in AUTO+ mode. (Auto/Off)

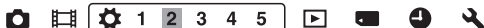

Grid Line (176)	Sets a grid line display to enable alignment to a structural outline. (Rule of 3rds Grid/Square Grid/Diag. + Square Grid/Off)
Auto Review (176)	Displays the captured image after shooting. Sets auto review. (10 Sec/5 Sec/2 Sec/Off)

DISP Button(Monitor) (87)	Allows you to select the available screen display modes of the LCD monitor that can be selected by pressing the DISP button. (Graphic Display/Display All Info./No Disp. Info./Level/Histogram/For viewfinder)
DISP Button(Finder) (87)	Allows you to select the available screen display modes of the viewfinder that can be selected by pressing the DISP button. (Graphic Display/Display All Info./No Disp. Info./Level/Histogram)
Peaking Level (124)	Enhances the outline of in-focus ranges with a specific color. (High/Mid/Low/Off)
Peaking Color (124)	Sets the color used for the peaking function. (Red/Yellow/White)
Live View Display (89)	Sets whether or not to display the effect of a function on the screen, such as the effect of the exposure compensation value. (Setting Effect ON/Setting Effect OFF)

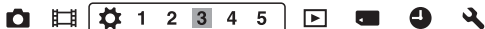

Func. of AEL button (176)	Assigns the desired function to the AEL button. (Exposure Comp./Drive Mode/Flash Mode/AF area/Face Detection/Smile Shutter/ISO/Metering Mode/Flash Comp./White Balance/DRO/Auto HDR/Creative Style/Picture Effect/Image Size/Quality/AEL hold/AEL toggle/ AEL hold/ AEL toggle/AF/MF Control Hold/AF/MF Control Toggle/Object Tracking/AF lock/Aperture Preview/Shot. Result Preview/Smart Telecon./Focus Magnifier/Memory)
ISO Button (177)	Assigns the desired function to the ISO button. (Exposure Comp./Drive Mode/Flash Mode/AF area/Face Detection/Smile Shutter/ISO/Metering Mode/Flash Comp./White Balance/DRO/Auto HDR/Creative Style/Picture Effect/Image Size/Quality/AEL hold/AEL toggle/ AEL hold/ AEL toggle/AF/MF Control Hold/AF/MF Control Toggle/Object Tracking/AF lock/Aperture Preview/Shot. Result Preview/Smart Telecon./Focus Magnifier/Memory)

AF/MF button (177)	Assigns the desired function to the AF/MF button. (Exposure Comp./Drive Mode/Flash Mode/AF area/Face Detection/Smile Shutter/ISO/Metering Mode/Flash Comp./White Balance/DRO/Auto HDR/Creative Style/Picture Effect/Image Size/Quality/AEL hold/AEL toggle/ AEL hold/ AEL toggle/AF/MF Control Hold/AF/MF Control Toggle/Object Tracking/AF lock/Aperture Preview/Shot. Result Preview/Smart Telecon./Focus Magnifier/Memory)
Preview Button (177)	Selects the method to be used for the operating preview button. (Shot. Result Preview/Aperture Preview)
Focus Hold Button	Sets the function of the focus hold button of the lens. (Focus Hold/D.O.F.Preview)
Smart Telecon. Button (124, 153)	Selects the operation method for the button. (Smart Telecon./Focus Magnifier)



Ctrl dial setup	Sets the functions of the front control dial and rear control dial between adjustment of the shutter speed and that of the aperture when the exposure mode is set to M. (SS F/no./ F/no. SS)
Dial exp.comp (50)	Compensates the exposure with the front or rear control dial. (Off/ Front dial/ Rear dial)
Exp.comp.set	Sets whether or not to compensate the exposure within the flash light range. (Ambient&flash/Ambient only)
Bracket order	Selects the order in exposure bracket and white balance bracket shooting. (0 → - → +/- → 0 → +)
AF drive speed	Selects the focusing speed in autofocus mode. (Fast/Slow)



Lens Comp.: Shading (180)	Compensates for the shaded corners of the screen caused by the lens attached. (Auto/Off)
Lens Comp.: Chro. Aber. (180)	Reduces the color deviation at the corners of the screen caused by the lens attached. (Auto/Off)

Lens Comp.: Distortion (180)	Compensates for distortion on the screen caused by the lens attached. (Auto/Off)
Front Curtain Shutter (177)	Sets whether or not to use the electronic front curtain shutter function. (On/Off)
Face Registration (128)	Registers or changes the person to be given priority in the focus. (New Registration/Order Exchanging/Delete/Delete All)

Playback menu



Delete (40, 165)	Deletes images. (Multiple Img./All in Folder/All AVCHD view files)
View Mode (161)	Allows you to determine how to group the playback images. (Folder View(Still)/Folder View(MP4)/AVCHD View)
Slide Show (162)	Shows a slide show. (Repeat/Interval/Image Type)
3D Viewing (167)	Plays back 3D-images using a 3D-compatible TV connected to the camera.
Protect (164)	Protects or cancels protection for an image. (Multiple Img./Cancel All Images/Cancel All Movies(MP4)/Cancel All AVCHD view files)
Specify Printing (198)	Specifies or unspecifies the images for DPOF. (DPOF Setup/Date Imprint)

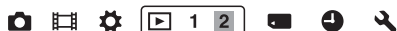

Volume Settings	Sets the volume for movie playback.
Playback Display (162)	Sets how to play back an image recorded in portrait. (Auto Rotate/Manual Rotate)

Memory Card Tool menu



Format (181)	Formats the memory card.
File Number (181)	Sets the method used to assign file numbers to still images and movies. (Series/Reset)

Folder Name (181)	Sets the folder format for still images. (Standard Form/Date Form)
Select REC Folder (182)	Changes the selected folder for storing still images.
New Folder (182)	Creates a new folder for storing still images and movies.
Recover Image DB (183)	Recovers the image database file and enables recording and playback.
Display Card Space	Displays the remaining recording time of movies and the recordable number of still images on the memory card.

Clock setup menu









Date/Time Setup (33)	Sets date and time, and daylight savings.
Area Setting (34)	Sets the location of use.







Setup menu



Menu start	Sets the default position of the cursor on the menu to the top item or the last-selected item. (Top/Previous)
LCD Brightness (178)	Sets the brightness of the LCD monitor. (Auto/Manual)
Viewfinder Bright. (178)	Sets the brightness of the viewfinder. (Auto/Manual)
GPS Settings (169) (SLT-A77V only)	Sets the GPS functions.
Power Save (179)	Sets the interval after which power save mode engages. (30 Min/5 Min/1 Min/20 Sec/10 Sec)
HDMI Resolution (167)	Sets the resolution when the camera is connected to an HDMI TV. (Auto/1080p/1080i)
CTRL FOR HDMI (168)	Operates the camera from a TV that support "BRAVIA" Sync. (On/Off)

       1 2 3	
Upload Settings* (183)	Sets the upload function of the camera when using an Eye-Fi card. (On/Off)
USB Connection (191)	Sets the USB connection method. (Auto/Mass Storage/MTP)
Audio signals	Sets whether or not to use the beep sound when the focus is achieved or the self-timer is working. (On/Off)
Cleaning Mode (200)	Starts the cleaning mode to clean the image sensor.
Delete confirm.	Selects the default item of the delete confirmation screen between [Delete] and [Cancel]. ("Delete" first/"Cancel" first)
AF Micro Adj. (121)	Allows you to make fine adjustments to the position of the focus. (AF Adjustment Setting/amount/Clear)

* Appears when an Eye-Fi card (sold separately) is inserted in the camera.

       1 2 3	
Version (190)	Displays the camera software version.
Language	Selects the language.
Mode Dial Guide	Turns on or off the mode dial guide (the explanation of each shooting mode). (On/Off)
Demo Mode	Sets the demonstration playback of a movie to on or off. (On/Off)
Initialize (186)	Restores the settings to their defaults. (Reset Default/Rec mode reset/Custom reset)

Using the guide function of the camera

In-Camera Guide

When you press the ? (In-Camera Guide) button on the Fn screen or menu screen, a guide in accordance with the currently selected function or setting appears automatically.

Select unavailable functions or settings on the Fn screen, then press the center of the multi-selector, the appropriate setup is indicated in order to enable them.

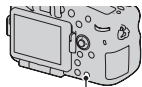

? (In-Camera Guide) button

Using with your computer

Following applications are contained on the CD-ROM (supplied) to allow more versatile use of images shot with your camera.

- “Image Data Converter”
- “PMB” (Picture Motion Browser)

If “PMB” has already been installed on the computer, and the version number of the previously installed “PMB” is lower than that of the “PMB” on the CD-ROM (supplied), install “PMB” also from the CD-ROM (supplied).

For detailed notes on installation, also see page 73.

Note

- “PMB” is not compatible with Macintosh computers.

Recommended computer environment (Windows)

The following computer environment is recommended when using the supplied software and importing images via a USB connection.

OS (pre-installed)	Microsoft Windows XP* SP3/Windows Vista** SP2/ Windows 7 SP1
“PMB”	CPU: Intel Pentium III 800 MHz or faster (For playing/editing the High Definition movies: Intel Core Duo 1.66 GHz or faster/Intel Core 2 Duo 1.66 GHz or faster, Intel Core 2 Duo 2.26 GHz or faster (HD FX/HD FH), Intel Core 2 Duo 2.40 GHz or faster (HD PS)) Memory: 512 MB or more (For playing/editing the High Definition movies: 1 GB or more) Hard Disk: Disk space required for installation-approximately 500 MB Display: Screen resolution-1024 × 768 dots or more
“Image Data Converter Ver.4”	CPU/Memory: Pentium 4 or faster/1 GB or more Display: 1024 × 768 dots or more

* 64-bit editions and Starter (Edition) are not supported. Windows Image Mastering API (IMAPI) Ver.2.0 or later is required to use the function for creating discs.

** Starter (Edition) is not supported.

Recommended computer environment (Macintosh)

The following computer environment is recommended when using the supplied software and importing images via a USB connection.

OS (pre-installed)	USB Connection: Mac OS X (v10.3, 10.4, 10.5, 10.6) “Image Data Converter Ver.4”: Mac OS X (v10.5, 10.6 (Snow Leopard))
“Image Data Converter Ver.4”	CPU: Intel Core Solo/Core Duo/Core 2 Duo or faster Memory: 1 GB or more is recommended. Display: 1024 × 768 dots or more

Notes

- Operation is not assured in an environment based on an upgrade of the operating systems described above or in a multi-boot environment.
- If you connect 2 or more USB devices to a single computer at the same time, some devices, including the camera, may not operate, depending on the types of USB devices you are using.
- Connecting the camera using a USB interface that is compatible with Hi-Speed USB (USB 2.0 compliant) allows advanced transfer (high speed transfer), as the camera is compatible with Hi-Speed USB (USB 2.0 compliant).
- When your computer resumes activity from suspend or sleep mode, communication between the camera and your computer may not recover at the same time.

Using the software

Installing the software (Windows)

Log on as Administrator.

1 Turn on your computer, and insert the CD-ROM (supplied) into the CD-ROM drive.

The installation menu screen appears.

- If it does not appear, double-click [Computer] (For Windows XP: [My Computer]) →  (SONYPMB) → [Install.exe].
- If the AutoPlay screen appears, select “Run Install.exe” and follow the instructions that appear on the screen to proceed with the installation.

2 Click [Install].

Make sure that both “Image Data Converter” and “PMB” are checked and follow the instructions on the screen.

- Connect the camera to the computer during the procedure following the instructions on the screen (page 191).
- When the restarting confirmation message appears, restart the computer following the instructions on the screen.
- DirectX may be installed depending on the system environment of your computer.

3 Remove the CD-ROM after the installation is complete.

The following software is installed and shortcut icons appear on the desktop.

“Image Data Converter”
“PMB”
“PMB Launcher”
“PMB Help”

Notes

- If “PMB” has already been installed on the computer, and the version of the previously installed “PMB” is higher than that of the “PMB” on the CD-ROM (supplied), installation is not required. The usable functions are activated when the camera is connected to the computer using the USB cable.

- If a version of “PMB” under 5.0.00 has been installed on your computer, you may be unable to use some functions of those “PMB” when installing the “PMB” from the supplied CD-ROM. Also, “PMB Launcher” is installed from the supplied CD-ROM and you can start “PMB” or other software by using the “PMB Launcher.” Double-click the “PMB Launcher” short-cut icon on the computer screen to start “PMB Launcher.”

Installing the software (Macintosh)

Log on as Administrator.

1 Turn on your Macintosh computer, and insert the CD-ROM (supplied) into the CD-ROM drive.

2 Double-click the CD-ROM icon.

3 Copy the [IDC_INST.pkg] file in the [MAC] folder to the hard disk icon.

4 Double-click the [IDC_INST.pkg] file in the copy-to folder.

Follow the instructions on the screen to complete the installation.

Using “Image Data Converter”

With “Image Data Converter” you can do the following, etc.:

- To edit images recorded in RAW format with various corrections, such as tone curve, and sharpness.
- To adjust images with white balance, exposure, and creative style, etc.
- To save the images displayed and edited on a computer.
- You can either save the image as RAW format or save it in the general file format.
- To display and compare RAW/JPEG images recorded with this camera.
- To rate the images on a scale of five.
- To set color labels.

To use “Image Data Converter,” refer to Help.

Click [Start] → [All Programs] → [Image Data Converter] → [Help] → [Image Data Converter Ver.4].

Using “PMB”

With “PMB” you can do the following, etc.:

- To set images shot with the camera and display them on the computer.
- To organize images on the computer on a calendar by shooting date to view them.
- To retouch (red-eye reduction, etc.), print, send still images as e-mail attachments, and change the shooting date.
- To display the shooting location of the image on the map (SLT-A77V only).
- To print or save still images with the date.
- To create Blu-ray discs or DVD discs from AVCHD View movies imported to a computer. (An Internet connection environment is required when a Blu-ray disc/DVD disc is created for the first time.)

Notes

- “PMB” is not compatible with Macintosh computers.
- Movies recorded with the [60p 28M(PS)]/[50p 28M(PS)], [60i 24M(FX)]/[50i 24M(FX)] or [24p 24M(FX)]/[25p 24M(FX)] setting in [Record Setting] are converted by “PMB” in order to create an AVCHD disc. This conversion can take a long time. Also, you cannot create a disc with the original image quality. If you want to keep the original image quality, you must store your movies on a Blu-ray disc.
- “AVCHD View movies” are movies that were recorded in the [AVCHD 60i/60p]/[AVCHD 50i/50p] mode of [File Format].

To use “PMB,” refer to “PMB Help.”

Double-click the shortcut of  (PMB Help) on the desktop. Or, click [Start] → [All Programs] → [PMB] → [PMB Help].

“PMB” support page (English only)



<http://www.sony.co.jp/pmb-se/>

Selecting the method for creating a disc of movies

You can create a disc from AVCHD View movies that have been recorded with this camera.

Depending on the disc type, playable devices may vary. Select the method that suits your disc player.

Here, 2 ways of creating a disc of movies are described; creating a disc with a computer using “PMB” or creating a disc with devices other than a computer such as a DVD writer.

Player	Disc type	Feature
Blu-ray disc playback devices (Blu-ray disc player, PlayStation®3, etc.)	 Blu-ray	Using a Blu-ray disc enables you to record high-definition image quality (HD) movies of a longer duration than DVD discs.
AVCHD format playback devices (Sony Blu-ray disc player, PlayStation®3, etc.)	 AVCHD	High-definition image quality (HD) movies can be recorded on DVD media, such as DVD-R discs, and a high-definition image quality (HD) disc is created. <ul style="list-style-type: none">• You cannot play a high-definition image quality (HD) disc on ordinary DVD players.
Ordinary DVD playback devices (DVD player, computer that can play DVDs, etc.)	 STD	Standard definition image quality (STD) movies converted from high-definition image quality (HD) movies can be recorded on DVD media, such as DVD-R discs, and a standard definition image quality (STD) disc is created.

Creating a disc using a computer

You can import AVCHD View movies to a computer using “PMB” and create an AVCHD format disc or a standard definition image quality (STD) disc.

For details on the method for creating a disc using “PMB,” see “PMB Help.”









Notes

- To create Blu-ray discs, be sure to install [BD Add-on Software] from the “PMB” installation screen.

- The PlayStation®3 may not be available in some countries/regions.
- Movies recorded with the [60p 28M(PS)]/[50p 28M(PS)], [60i 24M(FX)]/[50i 24M(FX)] or [24p 24M(FX)]/[25p 24M(FX)] setting in [Record Setting] are converted by “PMB” in order to create an AVCHD disc. This conversion can take a long time. Also, you cannot create a disc with the original image quality. If you want to keep the original image quality, you must store your movies on a Blu-ray disc (page 196).
- To play back movies recorded with the [60p 28M(PS)]/[50p 28M(PS)] setting on a Blu-ray disc, the device that is compatible with the AVCHD Ver 2.0 format is required.
- “AVCHD View movies” are movies that were recorded in the [AVCHD 60i/60p]/[AVCHD 50i/50p] mode of [File Format].

Creating a disc with a device other than a computer

You can create a disc with a Blu-ray disc recorder and DVD writer. The disc type you can create depends on the device used.

Device		Disc type
	Blu-ray disc recorder: To create a Blu-ray disc or DVD with standard image quality (STD)	 
	DVD writer other than DVDDirect Express: To create an AVCHD disc or DVD with standard image quality (STD)	 
	HDD recorder, etc.: To create a DVD with standard image quality (STD)	

Notes

- For details on how to create a disc, refer to the operating instructions of the device you use.
- If you create a disc using Sony DVDDirect (DVD Writer), use the memory card slot of the DVD Writer or connect the DVD Writer via USB connection to transfer the data.
- If you use Sony DVDDirect (DVD Writer), check that the firmware is updated to the newest version.

For details, see the following URL:

<http://sony.storagesupport.com/>

- To copy movies recorded with the [60p 28M(PS)]/[50p 28M(PS)] setting to a Blu-ray disc, the device that is compatible with the AVCHD Ver 2.0 format is required. To play back the created Blu-ray disc, the device that is compatible with the AVCHD Ver 2.0 format is required.

List of icons on the screen

Graphic Display (LCD monitor)

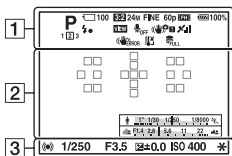

Display All Info. (LCD monitor)

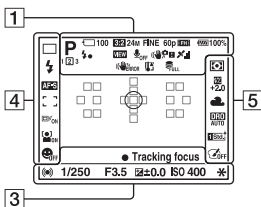

For playback (Basic information display)

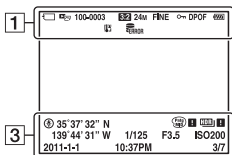

1

Display	Indication
AUTO AUTO+	Exposure mode (42)
P S A M	
3D	
1 2 3	Register number (185)
	Scene Recognition icons (43, 96)
	Memory card (27, 222)/ Upload (183)
100	Remaining number of recordable images
3:2 16:9	Aspect ratio of still images (172)
3D	3D Sweep Panorama (45, 99)
24M 12M 6.0M 20M 10M 5.1M	Image size of still images (53)
WIDE STD 16:9	
RAW RAW+J X.FINE FINE STD	Image quality of still images (172)

Others

Display	Indication
60p 60i 24p 50p 50i 25p	Frame rate of movies (114)
FX FH PS 1080 VGA	Image size of movies (114)
100%	Remaining battery (28)
	Flash charge in progress (47)
	Setting Effect OFF (89)
	No audio recording of movies (115)
	SteadyShot/Camera shake warning (94)
	GPS triangulating status (169) (SLT-A77V only)
	SteadyShot error (211)
	Overheating warning (16)
	Database file full (213)/ Database file error (213)
	View Mode (161)
100-0003	Folder - file number (193)
	Protect (164)
DPOF	DPOF set (198)
	Remaining battery warning (28)

2

Display	Indication
	Spot metering area (132)
	AF area (119)

Display	Indication
	Smart teleconverter (153)
	Shutter speed indicator (89)
	Aperture indicator (89)

3













Display	Indication
REC 0:12	Recording time of the movie (m:s)
	Focus (37, 118)
1/250	Shutter speed (105)
F3.5	Aperture (103)
	EV scale (49, 108, 157) (Only for viewfinder)
+3.0	Exposure compensation (49)
	AE lock (131)
	GPS information (SLT-A77V only)
35° 37' 32° N 139° 44' 31° W	Latitude and longitude display (SLT-A77V only)
	Auto HDR image warning (142)
	Picture Effect error (145)
ISO400	ISO sensitivity (139)
3/7	File number/Number of images in the view mode
2011-1-1 10:37AM	Date of recording

Functions available for each shooting mode

The functions you can use depend on the selected shooting mode.

In the table below, ✓ indicates the function available. – indicates the function not available.

The functions you cannot use are displayed in gray on the screen.

Shoot Mode	Exposure Comp. (49)	Self-timer (155)	Cont. Shooting (154)	Face Detection (127)	Smile Shutter (129)
AUTO (36, 96)	–	✓	✓	✓	✓
AUTO+ (43, 96)	–	✓	✓	✓	✓
SCN (44, 97)		–	✓	–	✓
		–	✓	✓	✓
		–	✓	–	✓
		–	✓	–	✓
		–	✓	–	✓
		–	✓	–	✓
		–	–	–	✓
		–	✓	–	✓
 (45, 99)	✓	–	–	–	–
 (45, 99)	✓	–	–	–	–
 (46, 101)	✓	–	–	–	–
P (102)	✓	✓	✓	✓	✓
A (103)	✓	✓	✓	✓	✓
S (105)	✓	✓	✓	✓	✓
M (107)	–	✓	✓	✓	✓
 (38, 111)	✓*	✓	✓	✓	–

















* When [Manual Exposure] is selected, this function is not available.

Flash modes available

The flash modes you can select depend on the shooting mode and functions selected.

In the table below, ✓ indicates the function selectable. – indicates the function not selectable.

The flash modes you cannot select are displayed in gray on the screen.

Shoot Mode	 (Flash Off)	 (Autoflash)	 (Fill-flash)	 (Rear Sync.)	 (Wireless)	
AUTO (36, 96)	✓	✓	✓	–	–	
AUTO+ (43, 96)	✓	✓	✓	–	–	
SCN (44, 97)		✓	✓	✓	–	–
		✓	–	✓	–	–
		✓	✓	✓	–	–
		✓	–	✓	–	–
		✓	–	✓	–	–
		✓	–	–	–	–
		✓	–	–	–	–
	–	✓	–	–	–	
 (45, 99)	✓	–	–	–	–	
3D (45, 99)	✓	–	–	–	–	
 (46, 101)	–	–	✓	✓	✓	
P (102)	–	–	✓	✓	✓	
A (103)	–	–	✓	✓	✓	
S (105)	–	–	✓	✓	✓	
M (107)	–	–	✓	✓	✓	
 (38, 111)	✓	–	–	–	–	

Others

Advanced operations

This section provides further information on the camera.



Preparation (Advanced operations)

Setting up the camera

Removing the eyecup

When attaching the FDA-A1AM Angle Finder (sold separately) to the camera, remove the eyecup.

Carefully slide the eyecup off by pushing on each side of the eyecup.

- Put your fingers under the eyecup, and slide it upward.

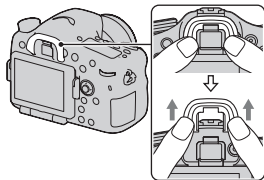

Note

- When the FDA-A1AM Angle Finder (sold separately) is attached to the camera, setting [Eye-Start AF] to [Off] is recommended because the eyepiece sensors located above the viewfinder may be activated.

The screen displayed for shooting mode

Selecting the screen mode

You can select the desired screen mode. When you switch the screen by pressing the DISP button (page 52), only selected screens are displayed. You can set the available screens to be displayed on the LCD monitor and the viewfinder separately.

1 MENU button → ⚙ 2 → [DISP Button(Monitor)] or [DISP Button(Finder)]

2 Select the desired display with ▲/▼/◀/▶ on the multi-selector, then press the center of the multi-selector.

3 Press the MENU button.

Histogram

The histogram displays the luminance distribution that shows how many pixels of a particular brightness exist in the picture.

The exposure compensation will change the histogram accordingly.

Both ends of the histogram show a high-key or low-key portion. You cannot restore these areas with a computer later. Adjust the exposure if necessary and shoot again.

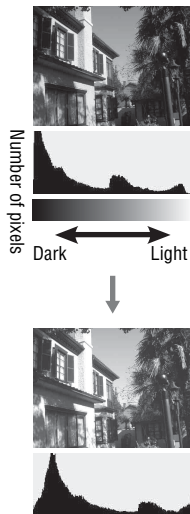

Notes

- The histogram does not indicate the final recorded image. It indicates the condition of the image just monitored on the screen. The histogram will differ based on aperture setting, etc.
- The histogram differs between shooting and playback in the following situations:
 - When firing the flash.
 - When the subject has low intensity, such as night scenery.

The digital level gauge

The digital level gauge indicates whether the camera is level in both the horizontal and front-back directions. When the camera is level in one direction, the indicator turns to green.

Horizontal direction

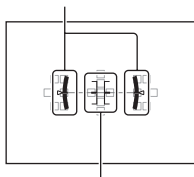

Front-back direction

Notes

- The error of the digital level gauge is larger if you tilt the camera too far forward or backward.
- A tilt of $\pm 1^\circ$ may be indicated even if the camera is almost level.

Graphic Display

The Graphic Display shows the shutter speed and aperture value as graphs, and clearly illustrates how the exposure works. The pointers on the shutter speed indicator and aperture indicator indicate the current value.

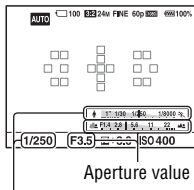

Shutter speed

Monitoring the subject through the lens without effects displayed

You can monitor the subject through the lens without effects, such as the exposure compensation, white balance, Creative Style, Picture Effect etc., displayed.

MENU button → **2** → **[Live View Display]** → **[Setting Effect OFF]**

- When [Setting Effect OFF] is selected, the Live View image in M mode is always displayed with the appropriate brightness.

Note

- [Setting Effect OFF] cannot be selected when the exposure mode is set to AUTO, AUTO+, Sweep Panorama, 3D Sweep Panorama, Movie or Scene Selection.

List of icons for viewfinder mode

When [For viewfinder] in [DISP Button(Monitor)] is activated, you can set the status of the LCD monitor to one suitable for used with the viewfinder, by pressing the DISP button.

See pages in parentheses for details of operation.

In AUTO, AUTO+, or Scene Selection mode

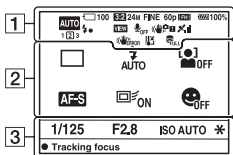



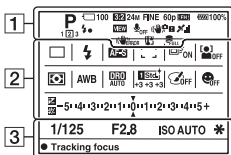

In Continuous Advance Priority AE/P/A/S/M mode



1

Display	Indication
AUTO AUTO+ [Shutter icon] [Aperture icon] P A S M [Hand icon] [Hand icon] [Hand icon] [Hand icon] [Hand icon] [Hand icon] [Hand icon] [Hand icon] [Hand icon] [Hand icon] [Hand icon] [Hand icon]	Exposure mode (42)
1 2 3	Register number (185)

Display	Indication
[Memory card icon] [Wi-Fi icon] [Wi-Fi OFF icon] [Wi-Fi signal strength icon] [Wi-Fi signal strength icon]	Memory card (27, 222)/ Upload (183)
100	Remaining number of recordable images
3:2 16:9	Aspect ratio of still images (172)
3D	3D Sweep Panorama (45, 99)

Display	Indication
	Smile Shutter (129)
	Exposure compensation (49)/Metered Manual (108)
	Flash compensation (132)
	EV scale (49, 108, 157)

3

Display	Indication
1/125	Shutter speed (105)
F2.8	Aperture (103)
ISO AUTO	ISO sensitivity (139)
*	AE lock (131)

Display panel

You can adjust the shutter speed, aperture, exposure compensation, flash compensation, ISO sensitivity, white balance, drive mode and image quality by checking the display panel on the top of the camera.



Shutter speed (105)/ Aperture (103)		Exposure (49)/Flash compensation (132)	
ISO sensitivity (139)		White balance (148)	
Drive mode (51, 154)		Image quality (172)	

Display	Indication
	Remaining battery (28)
[100]	Remaining number of recordable images (227)*

* Even when the remaining number of recordable images is more than 9 999, “9999” is displayed on the display panel.

To turn on the backlight of the display panel

Press the display panel illumination button on the top. Pressing again turns off the backlight.

Display panel illumination button





Shooting a clear image without camera shake

“Camera shake” refers to unwanted movement of the camera that occurs after the shutter button has been pressed, resulting in a blurred image. To reduce camera shake follow the instructions below.

Camera shake warning indicator

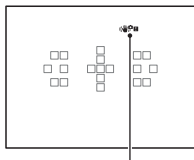
Due to potential camera shake, the  (Camera shake warning) indicator flashes. In this case, use a tripod or the flash.



 (Camera shake warning) indicator



Note

- The  (Camera shake warning) indicator is displayed only in the modes that automatically set the shutter speed. This indicator is not displayed in M/S modes or when you record movies.

Using the SteadyShot function

The SteadyShot function is available with this camera to reduce camera shake. The SteadyShot function can be set separately for still image shooting and for movie recording.

The SteadyShot function is set to [On] in the default settings.

MENU button →  **2** or  **1** → [SteadyShot] → **Select the desired setting**

Note

- The SteadyShot function may not work optimally when the power has just been turned on, right after you point the camera towards a subject, or when the shutter button has been pressed all the way down without stopping halfway.

Using a tripod

In the following cases, we recommend that you mount the camera on a tripod.

- Shooting without a flash under dark conditions.
- Shooting with slow shutter speeds, which are typically used in night-time shooting.
- Shooting a close subject, such as in macro shooting.
- Shooting with a telescopic lens.

Note

- When using a tripod, deactivate the SteadyShot function because there is a potential for malfunction of the SteadyShot function.

Selecting the shooting mode

AUTO AUTO

Set the mode dial to **AUTO**, and shoot images (page 36).

Note

- Since the camera turns on the automatic setting function, many features will be unavailable, such as exposure compensation, ISO setting. If you want to adjust various settings, set the mode dial to P, then shoot your subject.

AUTO⁺

Set the mode dial to **AUTO⁺ (Auto+)**, and shoot images (page 43).

To set the continuous shooting

MENU button →  **1** → [Auto+ Cont. Shooting] → **Select the desired setting**

To select the storage method to be used for recorded images

In continuous shooting, you can select a storage method that allows the camera either to store 1 appropriate image from among the continuously shot images or store all the images.

MENU button →  **1** → [Auto+ Image Extract.] → **Select the desired setting**

Notes







- Even when you set [Auto+ Image Extract.] to [Off] with [Hand-held Twilight] selected from recognized scene mode, 1 combined image is saved.
- The numbers of images that were not saved are skipped when the images are extracted.



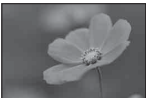

SCN Scene Selection

This mode is suitable for

- Shooting with preset settings according to the scene

Set the mode dial to **SCN (Scene Selection)**, select the desired mode, and shoot images (page 44).

 (Portrait)	<p>Blurs away backgrounds and sharpens the subject. Expresses skin tones softly.</p> <ul style="list-style-type: none"> • To blur the background more, set the lens to the telephoto position. • You can shoot a vivid image by focusing on the eye that is closer to the lens. • Use the lens hood to shoot backlit subjects. • Use the red-eye reduction function if the eyes of your subject turn red from the flash (page 64). 	
 (Sports Action)	<p>Shoots a moving subject at a fast shutter speed so that the subject looks as if it is standing still. The camera shoots images continuously while the shutter button is pressed.</p> <ul style="list-style-type: none"> • Press and hold the shutter button halfway down until the right moment. 	
 (Macro)	<p>Shoots close subjects such as flowers, foods.</p> <ul style="list-style-type: none"> • You can shoot a closer subject using a macro lens (sold separately). • Set the flash mode to [Flash Off] when you shoot a subject within 1 m (3.3 feet). • When shooting in macro mode, the SteadyShot function will not be fully effective. Use a tripod to achieve better results. • The shortest focal distance does not change. 	
 (Landscape)	<p>Shoots the entire range of scenery in sharp focus with vivid colors.</p> <ul style="list-style-type: none"> • To accentuate the openness of the scenery, set the lens to wide angle. 	

☉ (Sunset)	Shoots the red of the sunrise or sunset beautifully.	
☾ (Night Scene)	Shoots night scenes at a distance without losing the dark atmosphere of the surroundings. <ul style="list-style-type: none"> • The shutter speed is slower, so using a tripod is recommended. • The picture may not be taken properly when shooting a wholly dark night scene. 	
👤 (Hand-held Twilight)	Shoots night scenes with less noise and blur without using a tripod. A burst of shots are taken, and image processing is applied to reduce subject blur, camera shake, and noise. <ul style="list-style-type: none"> • Reducing blur is less effective even in [Hand-held Twilight] when shooting: <ul style="list-style-type: none"> – Subjects with erratic movement – Subjects too close to the camera – Subjects with a repeating pattern such as tiles, and subjects with little contrast such as sky, sandy beach, or lawn – Subjects with constant change such as waves or water falls • In the case of [Hand-held Twilight], block noise may occur when using a light source that flickers, such as fluorescent lighting. 	
👤 (Night Portrait)	Shoots portraits in night scenes. <ul style="list-style-type: none"> • The shutter speed is slower, so using a tripod is recommended. 	

Shooting technique

- When you want finer images, set the mode dial to P, A, S, or M and use the creative style function (page 145). In such cases, you can adjust the exposure, ISO, etc.

Notes

- Since the camera judges the settings automatically, many features will be unavailable, such as exposure compensation, ISO setting.
- The flash is set to [Autoflash] or [Flash Off] for each Scene Selection mode. You can change these settings (pages 47, 135).

Sweep Panorama/ 3D Sweep Panorama

This mode is suitable for

- Shooting expansive scenery, or high-rise buildings with dynamic composition.
- Shooting 3D-images with a sense of depths and viewing them using a 3D-compatible TV.

Set the mode dial to  (Sweep Panorama) or  (3D Sweep Panorama), and shoot images (page 45).

Notes

- If you cannot pan or tilt the camera across the entire subject within the given time, a gray area occurs in the composed image. If this happens, move the camera fast to record a full panoramic image.
- Since several images are stitched together, the stitched part will not be recorded smoothly. While shooting, do not tilt the camera back and forth, or right and left when you swing the camera straight ahead.
- Under low light conditions, panoramic images may be blurred or not be recorded.
- Under lights that flicker such as fluorescent light, the brightness or color of the combined image is not always the same.
- When the whole angle of panoramic shooting and the angle in which you fixed the focus and exposure with AE/AF lock are extremely different in brightness, color and focus, the shooting will not be successful. If this happens, change the lock angle and shoot again.
- [Sweep Panorama] or [3D Sweep Panorama] is not suitable when shooting:
 - Moving subjects.
 - Subjects too close to the camera.
 - Subjects with a repeating pattern such as tiles, and subjects with little contrast such as sky, sandy beach, or lawn.
 - Subjects with constant change such as waves or water falls.
 - Subjects with the sun or electric lights, etc. that are much brighter than surroundings.

- [Sweep Panorama] or [3D Sweep Panorama] recording may be discontinued in the following situations:
 - You pan or tilt the camera too fast or too slow.
 - There is too much camera shake.
- The camera continues shooting during [Sweep Panorama] or [3D Sweep Panorama] recording, and the shutter keeps clicking until the end of the shooting.

Tips for shooting a panoramic image

Pan or tilt the camera in an arc with a constant velocity and in the same direction as the indication on the screen. [Sweep Panorama] or [3D Sweep Panorama] is better suited for still subjects, rather than moving ones.

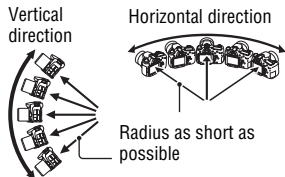

- In Sweep Panorama or 3D Sweep Panorama, it is recommended that you use a wide-angle lens.
- When you use a lens that has a long focal length, pan or tilt the camera more slowly than when you use a wide-angle lens.
- Determine the scene and press the shutter button halfway, so that you can lock the focus, exposure, and white balance.
- If a section with greatly varied shapes or scenery is concentrated along a screen edge, the image composition may fail. In such cases, adjust the frame composition so that the section is in the center of the image, then shoot again.

3D-images

Using the same operation as that for Sweep Panorama, the camera records multiple images and combines them to create a 3D-image.

You can view these 3D images using a 3D-compatible TV. For details on 3D-shooting, see page 221.

To change the image size

You can select the image size: MENU button → 1 → [Panorama: Size] or [3D Pan.: Image Size].

To set the pan or tilt direction

You can set the direction in which to pan or tilt the camera.

MENU button →  **1** → **[Panorama: Direction] or [3D Pan.: Direction]** → **Select the desired setting**

 **Cont. Priority AE****This mode is suitable for**

- Shooting a fast-moving subject continuously to capture a moment.
- Shooting a child's expressions, changing continuously from moment to moment.

Set the mode dial to  (Cont. Priority AE), and shoot images (page 46).

Shooting techniques

- When the autofocus mode is set to [Continuous AF], the focus and the exposure continue to be adjusted during shooting. The ISO sensitivity can be adjusted.
- In manual focus mode or when the autofocus mode is set to [Single-shot AF], you can adjust the ISO sensitivity and the aperture. When [Single-shot AF] is selected, the focus is fixed at the first image.

Notes

- The Face Detection function is turned off.
- When [Auto HDR] is selected, the DRO process is performed temporarily according to the DRO setting.
- Our measurement conditions. The speed of continuous shooting is slower, depending on shooting conditions.

P Program Auto

This mode is suitable for

- Using the automatic exposure, while keeping the custom settings for ISO sensitivity, Creative Style, D-Range optimizer, etc.

1 Set the mode dial to P.

2 Set the shooting functions to your desired settings (pages 116 to 158).

- To fire the flash, press the  button.

3 Adjust the focus and shoot the subject.

Program Shift

You can temporarily change the shutter speed and aperture value combination with the correct exposure determined by the camera maintained.

Rotate the front or rear control dial to select your desired combination while the focus is achieved.

The exposure mode indication changes to “P*.”

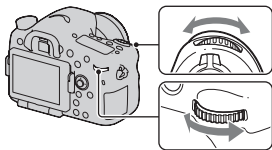

A Aperture Priority

This mode is suitable for

- Putting the subject in sharp focus and blur everything in front of and beyond the subject. Opening the aperture narrows the range that is in focus. (Depth of field becomes shallower.)
- Shooting the depth of the scenery. Narrowing down the aperture widens the range that is in focus. (Depth of field becomes deeper.)

1 Set the mode dial to A.

2 Select the aperture value (F-number) with the front or rear control dial.

- Smaller F-number: The foreground and background of the subject are blurred.
Larger F-number: The subject and its foreground and background are all in focus.
- You cannot check the blurring of an image on the LCD monitor or in the viewfinder. Check the recorded image and adjust the aperture.

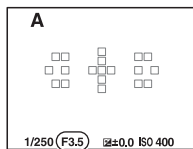
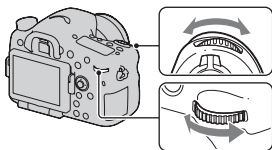

Aperture (F-number)

3 Adjust the focus and shoot the subject.

The shutter speed is automatically adjusted to obtain correct exposure.

- When the camera judges that the proper exposure is not obtained with the selected aperture value, the shutter speed flashes. In such cases, adjust the aperture again.

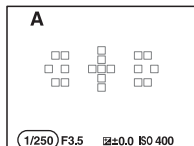

Shutter speed

Shooting techniques

- The shutter speed may become slower depending on the aperture value. When the shutter speed is slower, use a tripod.
- To blur the background more, use a telephoto lens or a lens that is equipped with a smaller aperture value (bright lens).
- You can check the approximate blurring of the image before recording using the preview button.

Note

- Press the  button when you shoot with the flash. However, the flash range differs according to the aperture value. When you shoot with the flash, check the flash range in “Specifications.”

To check blurring of the background (Preview button)

The LCD monitor and the viewfinder shows an image captured with the widest aperture. The change in aperture affects the sharpness of the subject image, creating a discrepancy between the sharpness of the image before shooting and that of the actual image.

While you are pressing the preview button, you can see the image with the aperture used in the actual shot so that you can check the approximate sharpness of the subject before shooting.

- Press the preview button after you adjust the focus.
- You can adjust the aperture in preview mode.

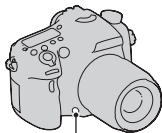

Preview button

S Shutter Priority**This mode is suitable for**

- Shooting a moving subject at a moment in time. Use a faster shutter speed to crisply shoot an instant of the movement.
- Tracing the movement to express the dynamism and flow. Use a slower shutter speed to shoot a trailing image of the moving subject.

1 Set the mode dial to S.

2 Select the shutter speed with the front or rear control dial.

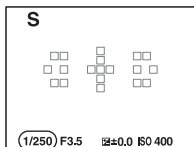
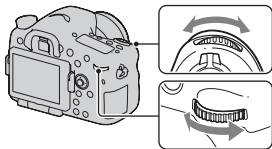

Shutter speed

3 Adjust the focus and shoot the subject.

The aperture is automatically adjusted to obtain correct exposure.

- When the camera judges that the proper exposure is not obtained with the selected shutter speed, the aperture value flashes. In such cases, adjust the shutter speed again.

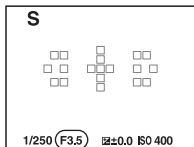



Aperture (F-number)

Shooting techniques

- When the shutter speed is slower, use a tripod.
- When shooting an indoor sport, select a higher ISO sensitivity.

Notes

- The  (Camera shake warning) indicator is not indicated in Shutter Priority mode.
- The higher the ISO sensitivity, the more conspicuous the noise.
- When the shutter speed is 1 second or longer, noise reduction (Long Exposure NR) will be done for the same amount of time that the shutter was open after shooting. You cannot do any further shooting during the reduction.

- Press the  button when you shoot with the flash. However, when using the flash, if you close the aperture (a larger F-number) by making the shutter speed slower, the light of the flash will not reach distant subjects.

M Manual Exposure

This mode is suitable for

- Shooting with the desired exposure setting by adjusting both the shutter speed and aperture.

1 Set the mode dial to M.

- ### 2 Rotate the front control dial to adjust the shutter speed, and rotate the rear control dial to adjust the aperture.

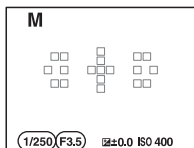
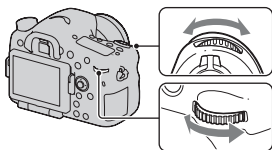

Shutter speed

Aperture (F-number)

3 Shoot the image after the exposure is set.

- Check the exposure value on the EV scale (Metered Manual*) when monitoring with the viewfinder.
Toward +: Images become brighter.
Toward -: Images become darker.
The ◀ ▶ arrow appears if the set exposure is beyond the range of the EV scale. The arrow starts flashing if the difference becomes greater.

* When the camera is in M mode, it will show an under or over compensation value based on the correct exposure using the index on the exposure compensation indicator.

In viewfinder mode

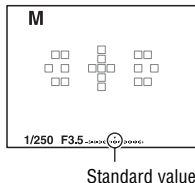

Standard value

Notes

- The (👉📷) (Camera shake warning) indicator is not indicated in manual exposure mode.
- When the mode dial is set to M, the ISO setting [AUTO] is set to [100]. In M mode, the ISO setting [AUTO] is not available. Set the ISO sensitivity as necessary (page 139).
- Press the ⚡ button when you shoot with the flash. However, the flash range differs according to the aperture value. When you shoot with the flash, check the flash range in “Specifications.”

Manual shift

You can change the shutter speed and aperture value combination without changing the exposure you set.

Rotate the front or rear control dial while pressing the AEL button to select the shutter speed and aperture value combination.

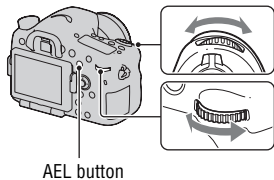

AEL button

M BULB

This mode is suitable for

- Shooting trails of light, such as fireworks.
- Shooting trails of stars.

1 Set the mode dial to M.

2 Rotate the front control dial to the left until [BULB] is indicated.

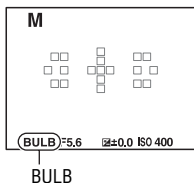
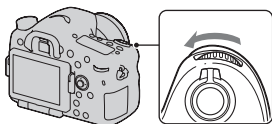

Shooting (Advanced operations)

3 Rotate the rear control dial to adjust the aperture (F-number).

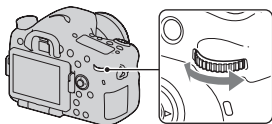

4 Press the shutter button halfway down to adjust the focus.

5 Press and hold the shutter button for the duration of the shooting.

As long as the shutter button is pressed, the shutter remains open.

Shooting techniques

- Use a tripod.
- Set the focus to infinity in manual focus mode when shooting fireworks, etc. When the infinity position of the lens is not known, first adjust the focus on fireworks that is set off in the same general area, then shoot them.
- Use the Wireless Remote Commander (sold separately) (page 158). Pressing the SHUTTER button on the Wireless Remote Commander triggers BULB shooting and pressing it again stops BULB shooting. You do not need to press and hold the SHUTTER button on the Wireless Remote Commander.
- If you use a Remote Commander that is equipped with a shutter button lock function (sold separately), you can leave the shutter open using the Remote Commander.

Notes

- When using a tripod, turn off the SteadyShot function (page 95).
- The longer the exposure time, the more conspicuous the noise on the image.
- After shooting, noise reduction (Long Exposure NR) will be done for the same amount of time that the shutter was open. You cannot do any further shooting during the reduction.
- When the Smile Shutter or Auto HDR function is activated, or when [Picture Effect] is set to [HDR Painting] or [Rich-tone Mono.], you cannot set the shutter speed to [BULB].
- If the Smile Shutter, Auto HDR function, or the [HDR Painting] or [Rich-tone Mono.] setting of [Picture Effect] is used with the shutter speed set to [BULB], the shutter speed is temporarily set to 30 seconds.
- It is recommended that you start BULB shooting after the temperature of the camera drops to prevent the quality of the image from deteriorating.

Movie recording setup

Recording movies easily

Movie recording can be started from any exposure mode. The shutter speed and aperture value are adjusted automatically.

Press the MOVIE button to start recording (page 38).

Shooting techniques

- Start recording after you adjust the focus.
- The following settings that were set during still image shooting can be used.
 - ISO
 - White Balance
 - Creative Style
 - Exposure compensation
 - AF area
 - Metering Mode
 - Face Detection
 - Object Tracking
 - D-Range optimizer
 - Lens Comp.: Shading
 - Lens Comp.: Chro. Aber.
 - Lens Comp.: Distortion
 - Picture Effect
- ISO, exposure compensation, Object Tracking, or AF area can be adjusted during movie recording.
- If you assign [AF lock] to the AEL button, ISO button, or AF/MF button, you can lock the focus by pressing these buttons in autofocus mode.

Notes

- In movie recording mode, the recordable area (angle of view) is narrower than that of still image shooting.
- When the [For viewfinder] screen is displayed on the LCD monitor, the LCD monitor is switched to the [Display All Info.] screen at the moment movie recording starts.

- Do not shoot a strong light source, such as the sun. The internal mechanism of the camera may be damaged.
- When you import AVCHD View movies to a computer, use “PMB” (pages 71, 192).
- When you continue to shoot for a long time, the temperature of the camera rises and the image quality may deteriorate.
- When the [L] mark is indicated, the temperature of the camera is too high. Turn the camera off and wait until the temperature of the camera drops. If you continue to shoot, the camera is turned off automatically.
- Since the shutter speed and aperture are automatically adjusted, the shutter speed will be higher and the movement of the subject may not be smooth under bright conditions. Selecting manual focus and adjusting the shutter speed or aperture may make the movement smoother (page 123).
- A value for the ISO sensitivity between ISO 100 and ISO 1600 can be selected when you record movies. If you start movie recording with a value of ISO 1600 or larger selected, the ISO sensitivity is switched to ISO 1600. If you start movie recording with a value of ISO 100 or smaller selected, the ISO sensitivity is switched to ISO 100. When you finish recording your movie, the ISO sensitivity setting is returned to the previous value.
- When ISO is set to [Multi Frame Noise Reduct.], [AUTO] is temporarily selected.
- You cannot select [Soft Focus], [HDR Painting], [Rich-tone Mono.], or [Miniature] in Picture Effect. When movie recording starts, Picture Effect is temporarily set to [Off].

Recording movies with the shutter speed and aperture adjusted

You can record movies with the shutter speed and aperture adjusted, controlling the background defocus or fluidity as intended.

1 Set the focus mode dial to MF (page 123).





2 Set the mode dial to  (Movie).

3 Select the desired mode with / on the multi-selector, then press the center of the multi-selector.

- To change the mode, press the Fn button, then select another mode.

4 Adjust the shutter speed and aperture value with the front or rear control dial.

5 Adjust the focus, then press the MOVIE button to start recording.

 P (Program Auto) (102)	Allows you to shoot with the exposure adjusted automatically (both the shutter speed and the aperture value). The other settings can be adjusted manually, and your setting values can be saved.
 A (Aperture Priority) (103)	Allows you to shoot after adjusting the aperture value manually using the front or rear control dial.
 S (Shutter Priority) (105)	Allows you to shoot after adjusting the shutter speed manually using the front or rear control dial.
 M (Manual Exposure) (107)	Allows you to shoot after adjusting the exposure manually (both the shutter speed and the aperture value) using the front or rear control dial.

File Format

MENU button →  **1** → **[File Format]** → **Select the desired format**

AVCHD 60i/60p* AVCHD 50i/50p**	<p>Records 60i/50i movies, 24p/25p movies or 60p/50p movies in AVCHD format. This file format is suitable for viewing the movie on a high-definition TV.</p> <p>You can create a Blu-ray disc, an AVCHD disc, or a DVD-Video disc using the supplied software “PMB.”</p> <ul style="list-style-type: none"> • 60i/50i movies are recorded at either 60 fields/second or at 50 fields/second, respectively. Both 60i and 50i movies utilize the interlace scanning system, Dolby Digital audio, and the AVCHD format. • 24p/25p movies are recorded at either 24 frames/second or at 25 frames/second, respectively. Both 24p and 25p movies utilize the progressive scanning system, Dolby Digital audio, and the AVCHD format. • 60p/50p movies are recorded at either 60 frames/second, or at 50 frames/second, respectively. Both 60p and 50p movies utilize the progressive scanning system and Dolby Digital audio.
---	---

MP4	<p>Records mp4 (AVC) movies. This format is suitable for WEB uploads, e-mail attachments, etc.</p> <ul style="list-style-type: none"> • Movies are recorded in MPEG-4 format at about 30 frames/second, utilizing the progressive scanning system, AAC audio, and the mp4 format. • You cannot create a disc from the movies recorded in this format using the supplied software "PMB."
------------	---

* 1080 60i-compatible device

** 1080 50i-compatible device

Record Setting

The higher the average bit-rate, the higher the image quality.

MENU button →  **1** → **[Record Setting]** → **Select the desired size**

[File Format]: [AVCHD 60i/60p]/[AVCHD 50i/50p]

File Format	Average bit-rate	Recording
60i 24M(FX)* 50i 24M(FX)**	24 Mbps	Records high image quality movies of 1920 × 1080 (60i/50i).
60i 17M(FH)* 50i 17M(FH)**	17 Mbps	Records standard image quality movies of 1920 × 1080 (60i/50i).
60p 28M(PS)* 50p 28M(PS)**	28 Mbps	Records highest image quality movies of 1920 × 1080 (60p/50p).
24p 24M(FX)* 25p 24M(FX)**	24 Mbps	Records high image quality moves of 1920 × 1080 (24p/25p). This produces a cinema-like atmosphere.
24p 17M(FH)* 25p 17M(FH)**	17 Mbps	Records standard image quality movies of 1920 × 1080 (24p/25p). This produces a cinema-like atmosphere.

[File Format]: [MP4]

File Format	Average bit-rate	Recording
1440×1080 12M	12 Mbps	Records movies of 1440 × 1080.
VGA 3M	3 Mbps	Records movies of VGA size.

* 1080 60i-compatible device

** 1080 50i-compatible device

Notes

- Movies recorded with the [60p 28M(PS)]/[50p 28M(PS)], [60i 24M(FX)]/[50i 24M(FX)] or [24p 24M(FX)]/[25p 24M(FX)] setting in [Record Setting] are converted by “PMB” in order to create an AVCHD disc. This conversion can take a long time. Also, you cannot create a disc with the original image quality. If you want to keep the original image quality, you must store your movies on a Blu-ray disc.
- To watch 60p/50p or 24p/25p movies on a TV, you need a TV that is compatible with 60p/50p or 24p/25p. If you use a non-compatible TV, the movies are converted to 60i/50i and output to the TV.

Audio Recording

When you record movies, the operating noise of the camera or lens may be recorded. You can record movies without audio.

MENU button →  **1** → **[Audio Recording]** → **[Off]**

When the focus mode is set to manual focus, you can disable recording of the operating noise of the lens for the autofocus (page 123).

To reduce wind noise

You can reduce wind noise by cutting bass sound input from the built-in microphone.

MENU button →  **1** → **[Wind Noise Reduct.]** → **[On]**

Notes

- Setting this item to [On] may cause some bass sound to be recorded with too low a volume. Set it to [Off] when the wind is not blowing.
- When an external microphone (sold separately) is used, this item does not function.

Adjusting the focus

There are 2 methods for adjusting the focus: autofocus and manual focus. Depending on the lens, the method for switching between the auto focus and manual focus is different.

The type of lens	The switch to be used	To switch to auto focus	To switch to manual focus
The lens is equipped with a focus mode switch	Lens (Set the focus mode dial on the camera to positions other than MF.)	Set the focus mode switch on the lens to AF.	Set the focus mode switch on the lens to MF.
The lens is not equipped with a focus mode switch	Camera	Set the focus mode dial on the camera to positions other than MF.	Set the focus mode dial on the camera to MF.

Autofocus

- 1 Set the focus mode dial on the camera to a desired position other than MF.

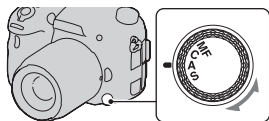

- 2 When the lens is equipped with the focus mode switch, set it to AF.

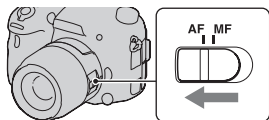

3 Press the shutter button halfway down to check the focus and shoot the image.

- When the focus is confirmed, the focus indicator changes to ● or ●● (page 118).
- The AF area where the focus has been confirmed turns green.

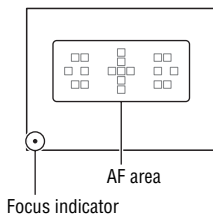

S (Single-shot AF) (AF-S)	The camera focuses and the focus is locked when you press the shutter button halfway down.
A (Automatic AF) (AF-A)	The [Autofocus Mode] is switched between Single-shot AF and Continuous AF according to the movement of the subject. When you press and hold the shutter button halfway down, if the subject is motionless, the focus is locked and if the subject is in motion, the camera continues to focus. <ul style="list-style-type: none"> • You can set the function of the “A” position of the focus mode dial to DMF (Direct Manual Focus) with [AF-A setup] (page 125).
C (Continuous AF) (AF-C)	The camera continues to focus while the shutter button is pressed and held halfway down. <ul style="list-style-type: none"> • The audio signals will not sound when the subject is in focus. • Focus-lock cannot be used.

Shooting technique

- Use [Single-shot AF] when the subject is motionless.
- Use [Continuous AF] when the subject is in motion.
- To select the AF area used for focusing, set up [AF area] (page 119).
- To change the focusing speed, set up [AF drive speed] (page 66).

Note

- While the camera is focusing automatically, do not touch the rotating focusing ring.

Focus indicator

Focus indicator	Status
● lit	Focus locked. Ready to shoot.
⊙ lit	Focus is confirmed. Focal point moves following a moving subject. Ready to shoot.
⊕ lit	Still focusing. You cannot release the shutter.
● flashing	Cannot focus. The shutter is locked.

Subjects that may require special focusing

Using the autofocus, it is hard to focus on the following subjects. In such cases, use the focus lock shooting feature (page 119) or manual focus (page 123).

- A subject that is low in contrast, such as blue sky or a white wall.
- Two subjects at different distances overlapping in the AF area.
- A subject that is composed of repeating patterns, such as the facade of a building.
- A subject that is very bright or glittering, such as the sun, the body of an automobile, or the surface of water.
- Ambient light is not sufficient.

To measure the exact distance to the subject

The ⊖ mark located on the top of the camera shows the location of the image sensor*. When you measure the exact distance between the camera and the subject, refer to the position of the horizontal line.

* The image sensor is the part of the camera that acts as the film.

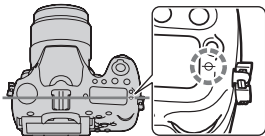

Note

- If the subject is closer than the minimum shooting distance of the attached lens, the focus cannot be confirmed. Make sure you put enough distance between the subject and the camera.

Focus-lock

1 Place the subject within the AF area and press the shutter button halfway down.

The focus is locked.

- Set [Autofocus Mode] to [Single-shot AF].



2 Keep the shutter button halfway down, and put the subject back in the original position to re-compose the shot.





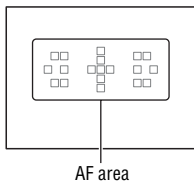

3 Press the shutter button fully down to take the picture.

AF area

Select the desired AF area to suit the shooting conditions or your preference. The AF area where the focus has been confirmed turns green and the other AF areas disappear.



Fn button → [] (AF area) → **Select the desired setting**

 (Wide)	The camera determines which of the 19 AF areas is used in focusing.
 (Zone)	Choose the zone for which you want to activate the focus from among left, right, or center zone with the multi-selector. The camera determines which of the AF areas in the selected zone is used in focusing.
 (Spot)	The camera uses the AF area located in the center area exclusively.
 (Local)	Choose the area for which you want to activate the focus from among 19 AF areas with the multi-selector.



Notes

- [AF area] is fixed to [Wide] and you cannot select other settings when the exposure mode is set to AUTO, AUTO+ or Scene Selection, or when the Object Tracking function is being used or the Smile Shutter is activated.
- The AF area may not be illuminated during continuous shooting or when the shutter button is pressed all the way down without pause.

The AF illuminator

You can set the AF illuminator to focus on a subject under dark lighting.

MENU button →  **2** → **[AF Illuminator]** → **Select the desired setting**

- AF illuminator does not operate when [Autofocus Mode] is set to **AF-C** (Continuous AF) or the subject is moving in **AF-A** (Automatic AF). (The  or  indicator lights.)
- AF illuminator does not operate when [AF area] is set to [Local] or [Zone], and the center area is not selected.
- The AF illuminator may not operate with focal lengths of 300 mm or longer.
- When an external flash (sold separately) that is equipped with an AF illuminator is attached, the AF illuminator of the external flash is used.
- AF illuminator does not operate when [Smile Shutter] is set to [On].

AF Micro Adj.

You can finely adjust the focus of each lens.

Perform this operation only when needed. Note that you may not be able to properly focus on a subject if you have made a poor adjustment.

MENU button →  **2** → **[AF Micro Adj.]** → **[On]** → **[amount]**
→ **Select the desired value**

- The larger the value, the farther the focusing position from the camera; the smaller the value, the nearer the focusing position to the camera.

Notes

- We recommend that you decide the value under actual shooting conditions.
- When you attach a lens that is registered on the camera, the registered value is displayed. When you attach an unregistered lens, “±0” is displayed. If “-” is displayed as the value, then a total of 30 lenses have been registered. When you want to register a new lens, attach a lens for which you can delete its registered value, and set that value to “±0,” or reset the values of all the lenses with [Clear].
- If you perform AF fine adjustment with a lens of other manufacturers, the adjustment values of Sony, Minolta, and Konica Minolta lenses may be affected. Do not use this function with any lens of other manufacturers.
- You cannot individually perform AF fine adjustment when using the Sony, Minolta, and Konica Minolta lenses that have the same specifications.

Object Tracking

Keeps the focusing on a moving subject while tracking it. The Object Tracking function is set to [On] in the default setting.

1 Press the center of the multi-selector on the recording information display.

A target frame appears.

- To turn off the Object Tracking function, press the Fn button, then set it to [Off].

2 Align the target frame with the subject to be tracked, and press the center of the multi-selector.

The camera starts tracking the subject.

- To cancel this tracking feature, press the center again.

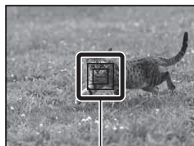

Target frame

3 Press the shutter button to shoot the subject.

Notes

- Tracking may be difficult in the following situations:
 - The subject is moving too quickly.
 - The subject is too small, or too large.
 - The contrast between the subject and the background is poor.
 - The subject is under dark lighting.
 - The ambient light changes.
- The Object Tracking function cannot be used when the exposure mode is set to Sweep Panorama, 3D Sweep Panorama, Continuous Advance Priority AE or [Hand-held Twilight] in Scene Selection, or smart teleconverter is used, the manual focus function is selected.
- The camera stops tracking a subject when the subject moves off of the screen.

When the subject to be tracked is a face

If the face disappears from the screen while the camera is tracking, and then returns to the screen, the camera focuses on that face again.

- If you trigger Smile Shutter while tracking a face, the face becomes the target of the smile detection feature.

Manual focus

When it is difficult to get the proper focus in autofocus mode, you can adjust the focus manually.

- 1 Set the focus mode switch on the lens to MF.

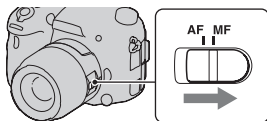

- 2 When the lens is not equipped with the focus mode switch, set the focus mode dial on the camera to MF.

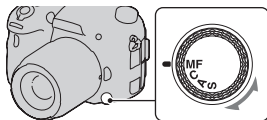

- 3 Rotate the focusing ring of the lens to achieve a sharp focus.

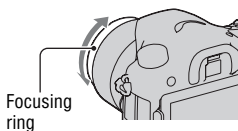

Notes

- When the Wide AF area is used, the center area is used for focusing; when the Zone AF area is used, a typical area of the selected area is used; and when the Local AF area is used, an area that is selected with the multi-selector is used.
- When using a tele converter (sold separately), etc., rotation of the focusing ring may not be smooth.
- The correct focus in the viewfinder is not achieved if the diopter is not adjusted properly in viewfinder mode (page 35).
- Make sure to set the focus mode dial to MF for manual focus. Do not rotate the focusing ring without setting to MF. Rotating the focusing ring forcibly without switching to MF may damage the focusing ring (Except for lenses that are equipped with the Direct manual focus function.).

Peaking

You can enhance the outline of in-focus ranges with a specific color in manual focus. This function allows you to confirm the focus easily.

MENU button →  **2** → [Peaking Level] → **Select the desired setting**

Notes

- Since the camera judges that sharp areas are in focus, the peaking level is different, depending on the subject, shooting situation, or on the lens used.
- The outline of in-focus ranges is not enhanced when the camera is connected using an HDMI cable.

To set the color of the peaking function

You can set the color used for the peaking function in manual focus.

MENU button →  **2** → [Peaking Color] → **Select the desired setting**

Note

- This item cannot be set when [Peaking Level] is set to [Off].

Focus Magnifier

You can check the focus by enlarging the image before shooting.

1 MENU button →  **3** → [Smart Telecon. Button] → [Focus Magnifier]

2 Press the Focus Magnifier button.

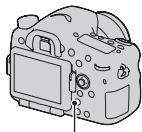

Focus Magnifier button

3 Press the Focus Magnifier button again to enlarge the image and select the portion you want to enlarge with ▲/▼/◀/▶ on the multi-selector.

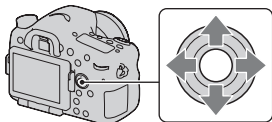

- Each time you press the Focus Magnifier button, the zoom scaling changes as follows: Full display → Approx. $\times 5.9$ → Approx. $\times 11.7$

4 Confirm and adjust the focus.

- Rotate the focusing ring to adjust the focus in manual focus mode.
- If you press the center of the multi-selector, the enlarged portion returns to the center.
- The Focus Magnifier function is canceled if you press the shutter button halfway down.

5 Press the shutter button fully down to shoot the image.

- You can record images when an image is enlarged, however the recorded image is for full display.
- The Focus Magnifier function will be released after shooting.

Direct manual focus

You can make fine adjustments after adjusting the focus in auto focus (Direct manual focus). You can assign this function to the “A” position of the focus mode dial.

You can quickly focus on a subject rather than using the manual focus from the beginning. This is convenient in cases such as macro shooting.

1 MENU button → 3 → [AF-A setup] → [DMF]

2 Set the focus mode dial to “A.”

3 Press the shutter button halfway down to lock the focus.

4 Turn the focusing ring to fine-tune the focus while pressing the shutter button halfway down.

Note

- The Direct manual focus function on the camera is not available when an SAM/SSM lens is attached.

The Direct manual focus function on the lens

When the lens is equipped with the Direct manual focus function with the focus mode set to [Single-shot AF] or [Automatic AF], you can finely adjust the focus with the focusing ring after focus lock (For example, the DT 16-50mm F2.8 SSM).

AF/MF control

You can switch between auto focus and manual focus without relaxing your position (AF/MF control).

Press the AF/MF button.

In auto focus mode: The focus mode is switched temporarily to the manual focus. Press and hold the AF/MF button and adjust the focus by rotating the focusing ring.

In manual focus mode: The focus mode is switched temporarily to the auto focus and the focus is locked.

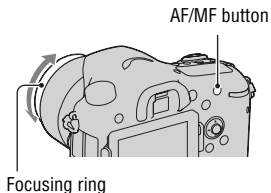

- You can maintain the selected mode without pressing and holding the AF/MF button with [AF/MF button] in the ⚙ Custom menu (page 177).

Note

- This function cannot be used with the DT 18-55mm F3.5-5.6.

Detecting faces

Face Detection

The camera detects faces, adjusts the focus, exposure, performs image processing, and adjusts flash settings.

Fn button →  **(Face Detection)** → **Select the desired setting**

Off	Turns off Face Detection.
On (Regist. Faces)	Enables Face Detection and prioritizes recognized faces that have been registered in [Face Registration] (page 128).
On	Enables Face Detection, but does not prioritize recognized faces.

The Face Detection frame

When the camera detects faces, gray Face Detection frames appear. When the camera judges that autofocus is possible, the Face Detection frames turn white.

When you press the shutter button halfway down, the Face Detection frames turn green.

- If a face is not positioned inside the AF area available when you press the shutter button halfway down, the AF area that is used for focusing turns green.
- When the camera detects multiple faces, the camera automatically selects a priority face and the single Face Detection frame turns white. A magenta frame appears on a face that is registered with [Face Registration].



Face Detection frames (gray)

Face Detection frames (white)

Shooting technique

- Compose to overlay the Face Detection frame and the AF area.

Notes

- When the exposure mode is Sweep Panorama, 3D Sweep Panorama or Continuous Advance Priority AE, the Face Detection function cannot be used.
- Up to 8 faces can be detected.
- The camera may not detect any faces, or may detect some other object, depending on the shooting conditions.
- During [Smile Shutter] shooting, [Face Detection] is temporarily set to [On (Regist. Faces)] even if it has been set to [Off].

Face Registration

The camera detects faces for which information has been registered in advance.

1 MENU button → **⚙ 5** → **[Face Registration]** → **[New Registration]**

2 Align the guide frame with the face to be registered, and press the shutter button.

3 Select [Enter] with ▲ on the multi-selector, then press the center of the multi-selector.

- Up to 8 faces of your subjects can be registered.
- Shoot the face from the front in a brightly lit place. The face may not be registered correctly if it is obscured by a hat, a mask, sunglasses, etc.

To change the priority of faces previously registered

When you have registered multiple faces, the priority order is set. You can change the priority order.

MENU button → **⚙ 5** → **[Face Registration]** → **[Order Exchanging]** → **Select a face for which you want to change the priority and the priority level**

To delete a registered face

You can delete a registered face.

MENU button → ⚙ 5 → [Face Registration] → [Delete] → Select the face you want to delete

- When you select [Delete All], you can delete all registered faces at one time.
- Even if you select [Delete], the data on registered faces remains stored in the camera. If you also want to delete this data from the camera, select [Delete All].

Smile Shutter

When the camera detects a smile, the shutter is released automatically.

1 Fn button → ☺_{OFF} (Smile Shutter) → [On] → Select the desired Smile Detection Sensitivity mode

You can set the sensitivity of the Smile Shutter function for detecting smiles to one of the following 3 options: ☺_{ON} (Slight Smile), ☺_{ON} (Normal Smile), and ☺_{ON} (Big Smile).

- When the Smile Shutter is activated, the Smile Detection Sensitivity indicator appears on the screen.

2 Wait detecting a smile.

The camera detects a smile and the focus is confirmed. When the smile level exceeds the ◀ point on the indicator, the camera records images automatically.

- When the camera detects the target faces, orange Face Detection frames appear around the faces. The Face Detection frames turn green when these subjects come into focus.

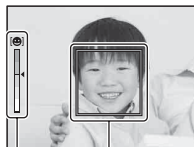

Face Detection frame
Smile Detection Sensitivity indicator

3 To stop shooting, Fn button → ☺_{ON} (Smile Shutter) → [Off]

Shooting techniques

- To focus on the smile, overlay the Face Detection frame and AF area.
- Do not cover the eyes with bangs, etc. Keep the eyes narrowed.
- Do not obscure the face with a hat, a mask, sunglasses, etc.
- Try to orient the face in front of the camera and keep it as level as possible.
- Hold a clear smile with an open mouth. The smile is easier to detect when the teeth are showing.
- If you press the shutter button while the Smile Shutter function is activated, the camera shoots the image, and then returns to Smile Shutter.

Notes

- The Smile Shutter function cannot be used when the exposure mode is set to Sweep Panorama, 3D Sweep Panorama, Continuous Advance Priority AE, Movie, or [Hand-held Twilight] in Scene Selection, or the manual focus is selected.
- The drive mode is automatically set to [Single Shooting] or [Remote Cdr.].
- The AF illuminator does not work with the Smile Shutter function.
- If the camera does not detect a smile, change the settings for Smile Detection Sensitivity.
- Smiles may not be detected correctly, depending on the shooting conditions.
- If you trigger Smile Shutter while tracking a face, the face becomes the target of the smile detection feature (page 121).

Adjusting the brightness of the image

AE Lock

When shooting into the sun or by a window, and the exposure may not be appropriate for the subject, use the light meter where the subject is bright enough and lock the exposure before shooting. To reduce the brightness of the subject, point the camera forwards a spot that is brighter than the subject and use the light meter to lock the exposure of the entire image. To make the subject brighter, point the camera forwards a spot that is darker than the subject and use the light meter to lock the exposure of the entire image.

This section describes how to shoot a brighter image of the subject using the  (Spot).

1 Fn button →  (Metering Mode) →  (Spot)

2 Adjust the focus on the portion you want to lock the exposure.

3 Press the AEL button to lock the exposure.

- * (AE lock mark) appears.
- The exposure value based on the locked exposure in the spot metering circle is also indicated on the EV scale.

AEL button

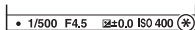
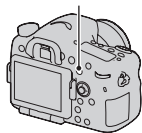



4 While pressing the AEL button, focus on the subject, and shoot the subject.

- If you continue to shoot with the same exposure value, press and hold the AEL button after the shooting. The setting is canceled when the button is released.
-

Metering Mode

Fn button →  **(Metering Mode)** → **Select the desired mode**

 (Multi segment)	This mode measures light on each area after dividing the total area into multiple areas and determines the proper exposure of the entire screen.
 (Center weighted)	While emphasizing the central area of the screen, this mode measures the average brightness of the entire screen.
 (Spot)	This mode measures light only in the spot metering circle located in the center area.

Shooting techniques

- Use [Multi segment] metering for general shooting.
- When there is a high contrast subject in the AF area, measure the light of the subject you want to shoot with the optimal exposure using the spot metering function and take advantage of an AE lock shooting (page 131).

Note

- When the exposure mode is set to AUTO, AUTO+, or Scene Selection, or when smart teleconverter is used, [Metering Mode] is fixed to [Multi segment] and you cannot select other modes.

Flash Comp.

When shooting with the flash, you can adjust the amount of flash light alone, without changing the exposure compensation. You can only change the exposure of a main subject which is within the flash range.

Fn button →  **(Flash Comp.)** → **Select the desired setting**

Toward +: Makes the flash level higher.

Toward -: Makes the flash level lower.

Notes

- This item cannot be set when the exposure mode is set to AUTO, AUTO+, Sweep Panorama, 3D Sweep Panorama, or Scene Selection.
- The higher flash effect may not be visible due to the limited amount of flash light, if the subject is outside the maximum range of the flash. If the subject is very close, the lower flash effect may not be visible.

Exposure compensation and flash compensation

Exposure compensation changes the shutter speed, aperture, and ISO sensitivity (when [AUTO] is selected) to perform the compensation.

Flash compensation only changes the amount of flash light.

Flash control

MENU button →  **2** → **[Flash control]** → **Select the desired setting**

ADI flash	This method controls the lighting of the flash, factoring in the focus distance information and light metering data from the pre-flash. This method enables an accurate flash compensation with virtually no effect from the reflection off the subject.
Pre-flash TTL	This method controls the amount of flash light depending on the data only from pre-flash light metering. This method is susceptible to the reflection off the subject.
Manual flash	Sets the amount of flash light with [Power ratio] and fires a certain amount of flash light, regardless of the brightness of a subject.

ADI: Advanced Distance Integration

TTL: Through the lens

- When [ADI flash] is selected, using a lens that is provided with a distance encoder feature can perform more accurate flash compensation by using more accurate distance information.

Notes

- When the distance between the subject and the external flash (sold separately) cannot be determined (wireless flash shooting using an external flash (sold separately), shooting with an off-camera flash using a cable, shooting with a macro twin flash, etc.), the camera automatically selects Pre-flash TTL mode.
- Select [Pre-flash TTL] in the following cases, as the camera cannot perform flash compensations with ADI flash.
 - A wide panel is attached to the HVL-F36AM flash.
 - A diffuser is used for flash shooting.
 - A filter with an exposure factor, such as an ND filter, is used.
 - A close-up lens is used.

- ADI flash is only available in combination with a lens that is provided with a distance encoder. To determine if the lens is equipped with a distance encoder, refer to the operating instructions supplied with the lens.
- This item cannot be set when the exposure mode is set to Sweep Panorama, 3D Sweep Panorama, or [Night Scene]/[Hand-held Twilight] in Scene Selection.

To adjust the amount of built-in flash light manually

You can adjust the amount of built-in flash light manually when [Flash control] is set to [Manual flash].

MENU button →  2 → [Power ratio] → Select the desired setting

The flash

Press the Fn button, select the desired flash mode, press the  button, and shoot images (page 47).

Shooting techniques

- The lens hood may block the light of the flash. Remove the lens hood when using the flash.
- When using the flash, shoot the subject at a distance of 1 m (3.3 feet) or greater.
- When shooting indoors or shooting nightscapes, you can use slow sync to shoot a brighter image of people and backgrounds.
- You can use rear sync to shoot a natural image of the trail of a moving subject such as a moving bicycle or a walking person.
- When using the HVL-F58AM/HVL-F43AM Flash (sold separately), you can shoot with the High-speed sync feature at any shutter speed. For details, refer to the operating instructions supplied with the flash.

Notes

- Do not hold the camera by grabbing the flash emitter.
- Shooting conditions required to prevent shadows from appearing on an image vary, depending on the lens.
- When the exposure mode is set to AUTO, AUTO+, or Scene Selection, the [Rear Sync.] and [Wireless] items cannot be selected and the slow sync shooting cannot be used.
- When the exposure mode is set to P, A, S, M, Continuous Advance Priority AE, the [Flash Off] or [Autoflash] items cannot be selected. If you do not want to use the flash, push the flash down.
- If you use the flash with a stereo microphone or similar device attached to the Auto-lock Accessory shoe, the flash may not pop up to the correct position and recorded images may have a shadow on their corners. Remove any device from the Auto-lock Accessory shoe.

Wireless flash

With a flash that has a wireless shooting function (sold separately), you can shoot with the flash without a cord, even when the flash is not attached to the camera. By changing the position of the flash, you can shoot an image

with a three dimensional feel by highlighting the contrast of light and shadow on the subject.

For the actual steps of shooting, refer to the operating instructions of the flash.

1 Attach the wireless flash to the Auto-lock Accessory shoe and turn both the camera and the flash on.

2 Fn button → (Flash Mode) → (Wireless)

3 Remove the wireless flash from the Auto-lock Accessory shoe and pop up the built-in flash.

- If you perform a test fire of the flash, press the AEL button.

Notes

- Turn off the wireless flash mode after wireless flash shooting. If the built-in flash is used while the wireless flash mode is still active, inaccurate flash exposures will result.
- Change the channel of the external flash when another photographer is using a wireless flash nearby and his/her flash light causes your external flash to fire. To change the channel of the external flash, refer to the operating instructions supplied with it.

Setup of the AEL button

When using a wireless flash, it is recommended that you set [Func. of AEL button] to [AEL hold] in the  Custom menu (page 176).

Wireless flash with lighting ratio control

You can use the wireless lighting ratio control in combination with the multiple flashes. For details, refer to the operating instructions supplied with the flash (HVL-F58AM, HVL-F43AM).

Slow Sync

If you use the slow sync shooting feature with a slower shutter speed, you can capture a clear image of both the subject and the background. This is convenient when you shoot a portrait at night with a dark background.

Shoot with the SLOW SYNC button pressed.

* lights up on the screen to indicate the exposure is locked.

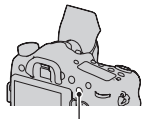

SLOW SYNC button

Notes

- When the mode dial is set to S or M, slow sync shooting is not available using the SLOW SYNC button.
- When a function other than the AEL function is selected in [Func. of AEL button], slow sync shooting is not available using the SLOW SYNC button. When the AEL function is selected in [ISO Button] or [AF/MF button], slow sync shooting is available using the ISO or AF/MF button.

Using a flash equipped with a flash sync terminal cord

Open the cover of the ⚡ (flash sync) terminal and plug the cord in.

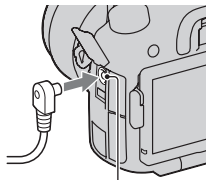

⚡ (flash sync) terminal

- You can use a flash equipped with a flash sync terminal of the opposite polarity.

Notes

- Select the manual exposure mode and set the shutter speed to 1/250 second. If the shutter speed recommended on the flash is slower than that, use the recommended speed or an even slower speed.
- If you cannot confirm your composition in dark situations, change the [Live View Display] setting so that the image is always displayed with the appropriate brightness (page 89).
- Use a flash with a flash sync voltage of 400 V or less.

- Before you connect the flash sync cord to the ⚡ (flash sync) terminal, turn off the power of the connected flash. If the power is on, it may flash when you connect the cord.
- The flash will always be full emission. Flash compensation (page 132) cannot be used.
- Using auto white balance is not recommended. Use custom white balance to gain more precise white balance.
- The flash indicator is not displayed when the ⚡ (flash sync) terminal is plugged in.

Setting ISO

Sensitivity to light is expressed by the ISO number (recommended exposure index). The larger the number, the higher the sensitivity.

1 Press the ISO button to display the ISO screen.

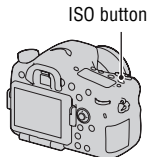

2 Select the desired setting with ▲/▼ on the multi-selector.

- The larger the number, the higher the noise level.
- If you want to select [Multi Frame Noise Reduct.], display the setup screen with ►, and select the desired value with ▲/▼.
- The number is incremented by 1/3 of a step using the rear control dial, with similar uses as the multi-selector, and it is incremented by 1 step using the front control dial.

Notes

- The recordable range of the brightness of a subject (dynamic range) is slightly narrower for areas where ISO is less than 100.
- When the exposure mode is set to AUTO, AUTO+, Sweep Panorama, 3D Sweep Panorama, or Scene Selection, ISO is fixed to [AUTO] and you cannot select other ISO numbers.
- When the exposure mode is set to P/A/S and ISO is set to [AUTO], ISO is automatically set between ISO 100 and ISO 1600.
- The [AUTO] setting is not provided in exposure mode M. If you change the exposure mode to M with the [AUTO] setting, it is switched to [100]. Set the ISO according to your shooting conditions.

To change the automatic adjustment range in [AUTO]

When [AUTO] is selected, press ►, select [ISO AUTO Maximum] or [ISO AUTO Minimum], then select the desired range.

Multi frame noise reduction

The camera automatically shoots multiple images continuously, combines the images, reduces the noise, and records 1 image. In multi frame noise reduction, you can select larger ISO numbers than the maximum ISO sensitivity.



The image recorded is 1 combined image.

Notes

- When [Quality] is set to [RAW] or [RAW & JPEG], this function cannot be used.
- The flash, D-Range optimizer, and [Auto HDR] cannot be used.

Compensating for the brightness and contrast automatically (D-Range)



Fn button → ** (DRO/Auto HDR)** → **Select the desired setting**

 (Off)	Does not use the DRO/Auto HDR functions.
 (D-Range Opt.)	By dividing the image into small areas, the camera analyses the contrast of light and shadow between the subject and the background, producing the image with the optimal brightness and gradation.
 (Auto HDR)	Shoots 3 images with different exposures, and then overlays correctly exposed image, the bright areas of an under exposed image and the dark areas of an over exposed image to create an image with rich gradation. 2 images are recorded: an image with the correct exposure and an overlaid image.

D-Range Optimizer

1 **Fn button** → ** (DRO/Auto HDR)** → ** (D-Range Opt.)**

2 **Select an optimal level with /** **** **on the multi-selector.**

 (Auto)	Corrects the brightness automatically.
 (Level)*	Optimizes the gradations of a recorded image in each area of the image. Select the optimal level between Lv1 (weak) and Lv5 (strong).

* Lv_ displayed with **** is the step currently selected.

Notes



- The setting is fixed to [Off] when the exposure mode is set to Sweep Panorama or 3D Sweep Panorama, or when [Multi Frame Noise Reduct.] or [Picture Effect] is used.
- The setting is fixed to [Off] when [Sunset], [Night Scene], [Night Portrait], or [Hand-held Twilight] is selected in Scene Selection. The setting is fixed to [Auto] when other modes are selected in Scene Selection.

- When shooting with the D-Range optimizer, the image may be noisy. Select the proper level by checking the recorded image, especially when you enhance the effect.

Auto HDR

1 Fn button →  (DRO/Auto HDR) →  (Auto HDR)

2 Select an optimal level with ◀/▶ on the multi-selector.

 (Auto HDR: Exposure Diff. Auto)	Corrects the exposure difference automatically.
 (Exposure Difference Level)*	Sets the exposure difference, based on the contrast of the subject. Select the optimal level between 1.0Ev (weak) and 6.0Ev (strong). For example: When 2.0Ev is selected, 3 images are overlaid: an image with -1.0Ev, an image with the correct exposure, and an image with +1.0Ev.

* _Ev displayed with  is the step currently selected.

Shooting technique

- Since the shutter is released 3 times for 1 shot, be careful about the following:
 - Use this function when the subject is motionless or does not blink.
 - Do not recompose.

Notes

- You cannot use this function on RAW images.
- When the exposure mode is set to AUTO, AUTO+, Sweep Panorama, 3D Sweep Panorama, Continuous Advance Priority AE or Scene Selection, or when [Multi Frame Noise Reduct.] is selected, you cannot select [Auto HDR].
- You cannot start the next shoot until the capture process is completed after you shoot.
- You may not obtain a desired effect depending on the luminance difference of a subject and the shooting conditions.
- When the flash is used, this function has little effect.

- When the contrast of the scene is low or when camera shake or subject blur is occurred, you may not obtain good HDR images. If the camera has detected a problem, **HDR**  is indicated on the recorded image to inform you of this situation. Shoot again, as necessary, paying attention to the contrast or blur.















Setting the image processing

Picture Effect

Select the desired effect filter to achieve more impressive and artistic expression.

Fn button →  (**Picture Effect**) → **Select the desired setting**

- When a mode that has a fine adjustment option is selected, select the desired setting with ◀/▶.

 (Off)	Does not use the Picture Effect function.
 (Toy Camera)	Creates the look of a Toy Camera photo with shaded corners and pronounced colors. You can set the color tone with ◀/▶.
 (Pop Color)	Creates a vivid look by emphasizing color tones.
 (Posterization)	Creates a high contrast, abstract look by heavily emphasizing primary colors, or in black and white. You can select primary colors or black and white with ◀/▶.
 (Retro Photo)	Creates the look of an aged photo with sepia color tones and faded contrast.
 (Soft High-key)	Creates an image with the indicated atmosphere: bright, transparent, ethereal, tender, soft.
    (Partial Color)	Creates an image which retains 1 specific color, but converts others to black and white. You can select a color with ◀/▶.
 (High Contrast Mono.)	Creates a high-contrast image in black and white.
 (Soft Focus)	Creates an image filled with a soft lighting effect. You can set the intensity of the effect with ◀/▶.
 (HDR Painting)	Creates the look of a painting, enhancing the colors and details. The camera releases the shutter 3 times. You can set the effect intensity with ◀/▶.
 (Rich-tone Mono.)	Creates an image in black and white with rich gradation and reproduction of details. The camera releases the shutter 3 times.
 (Miniature)	Creates an image which enhances the subject vividly, with the background defocused considerably. This effect may often be found in pictures of miniature models. You can select the area to be in focus with ◀/▶. The focus on other areas is greatly reduced.

Notes

- When Smart Teleconverter is used, the [Toy Camera] and [Miniature] effects are not available.
- When [Partial Color] is selected, images may not retain the selected color, depending on the subject or shooting condition.
- When the exposure mode is set to AUTO, AUTO+, Sweep Panorama, 3D Sweep Panorama or Continuous Advance Priority AE, or when [Quality] is set to [RAW] or [RAW & JPEG], Picture Effect cannot be used.
- When [HDR Painting], [Miniature], [Rich-tone Mono.] or [Soft Focus] is selected, you cannot confirm the effect before shooting. You cannot also set the drive mode.
- When the contrast of the scene is low or when significant camera shake or subject blur has occurred with [HDR Painting] or [Rich-tone Mono.] selected, you may not obtain good HDR images. If the camera detects such situation,  is indicated on the recorded image to inform you of this situation. Shoot again, as necessary, recomposing or paying attention to the blur.

Creative Style













You can select the desired style to be used to perform image processing, and adjust the contrast, saturation, and sharpness for each Creative Style. You can register and recall the settings of Creative Style for each style box. You can also adjust the exposure (shutter speed and aperture), unlike Scene Selection where the camera adjusts the exposure.



1 Fn button →  (Creative Style) → Select the style box you want to change the setting



2 Move the cursor to the right with  on the multi-selector, then select the desired style with .

3 When you want to adjust  (Contrast),  (Saturation), or  (Sharpness), select the desired item with , then adjust the value with .

 (Standard)	For shooting various scenes with rich gradation and beautiful colors.
--	---

 (Vivid)	The saturation and contrast are heightened for shooting striking images of colorful scenes and subjects such as flowers, spring greenery, blue sky, or ocean views.
 (Neutral)	The saturation and sharpness are lowered for capturing images in a quiet tone. This is also suitable for capturing image material to be modified with a computer.
 (Clear)	For capturing images in a clear tone with limpid colors in the highlighted area, suitable for capturing radiant light.
 (Deep)	For capturing images with deep and dense color expressions, suited to capturing the solid presence of the subject.
 (Light)	For capturing images with bright and uncomplicated color expressions, suited to capturing refreshingly light ambience.
 (Portrait)	For shooting the skin color in a soft tone, ideally suited to shooting portraits.
 (Landscape)	The saturation, contrast, and sharpness are heightened for shooting vivid and crisp scenery. Distant landscapes also stand out more.
 (Sunset)	For shooting the beautiful red of the setting sun.
 (Night Scene)	The contrast is attenuated for capturing a nightscape that is more faithful to the real view.
 (Autumn leaves)	For capturing autumn scenes, vividly highlighting the red and yellow of coloring leaves.
 (Black & White)	For shooting images in black and white monotone.
 (Sepia)	For capturing images in sepia monotone.

 (Contrast),  (Saturation), and  (Sharpness) can be adjusted for each style box item.





 (Contrast)	The higher the value selected, the more the difference of light and shadow is accentuated, thus making an impact on an image.
 (Saturation)	The higher the value selected, the more vivid the color. When a lower value is selected, the color of the image is restrained and subdued.
 (Sharpness)	Adjusts the sharpness. The higher the value selected, the more the contours are accentuated, and the lower the value selected, the more the contours are softened.

Notes

- When the exposure mode is set to AUTO, AUTO+ or Scene Selection, or the Picture Effect mode is selected, [Creative Style] is fixed to [Standard] and you cannot select other settings.
- When [Black & White] or [Sepia] is selected, you cannot adjust the saturation.

Adjusting the color tones (White balance)

The color tone of the subject changes depending on the characteristics of the light source. The table below shows how the color tone changes based on various light sources, compared with a subject that appears white under the sunlight.

Weather/ lighting	Daylight 	Cloudy 	Fluorescent 	Incandescent 
Characteristics of light	White	Bluish	Green-tinged	Reddish

Use this feature when the color tone of the image did not come out as you expected, or when you want to change the color tone on purpose for photographic expression.

Notes

- When the exposure mode is set to AUTO, AUTO+, or Scene Selection, [White Balance] is fixed to [Auto WB] and you cannot select other modes.
- If the only light source available is a mercury lamp or a sodium lamp, the camera will not be able to acquire the accurate white balance because of the characteristics of the light source. Use the flash in such cases.

WB button → Select the desired setting

- When you select a setting other than [C.Temp./Filter], press ► on the multi-selector so that the fine adjustment screen appears and you can adjust the color tone with ▲/▼/◀/▶, as necessary.

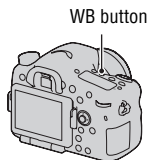

AWB (Auto WB)	The camera automatically detects a light source and adjusts the color tones.
☀ (Daylight)	If you select an option to suit a specific light source, the color tones are adjusted for the light source (preset white balance).
🏠 (Shade)	
☁ (Cloudy)	
💡 (Incandescent)	
☀⁻¹ (Fluor.: Warm White)	
☀⁰ (Fluor.: Cool White)	
☀⁺¹ (Fluor.: Day White)	
☀⁺² (Fluor.: Daylight)	
WB (Flash)	

Shooting techniques

- Use the white balance bracket function if you cannot get the desired color in the selected option (page 157).
- When you select [C.Temp./Filter], you can adjust the value to the desired value (page 150).
- When you select [Custom], you can register your setting (page 150).

The fine adjustment screen for color

You can perform a fine adjustment by combining the color temperature with the color filter.

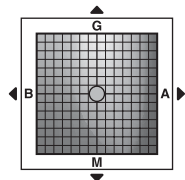

Color Temp.	Fine-tunes color in the B (blue) direction with ◀ and the A (amber) direction with ▶.
Color Filter	Fine-tunes color in the G (green) direction with ▲ and the M (magenta) direction with ▼.

Color Temp./Color Filter

1 WB button →  (C.Temp./Filter)
→ ▶

WB button

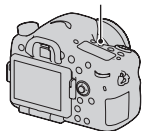

2 Set the color temperature with ▲/▼ on the multi-selector.

3 Press ▶ to display the fine adjustment screen and compensate the color to your preference with ▲/▼/◀/▶.

Note

- Since color meters are designed for film cameras, the values differ under fluorescent/sodium lamp/mercury lamps. We recommend that you use the custom white balance or perform a test shooting.

Custom white balance

In a scene where the ambient light consists of multiple types of light source, use of custom white balance is recommended in order to accurately reproduce the whiteness. 3 settings can be registered.

1 WB button → [SET] → press the center of the multi-selector

WB button

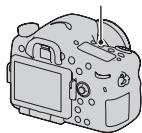

2 Hold the camera so that the white area fully covers the AF area located in the center, and then press the shutter button down.

The shutter clicks and the calibrated values (Color Temperature and Color filter) are displayed.

3 Select a register number with on the multi-selector, then press the center of the multi-selector.

The monitor returns to the recording information display with the memorized custom white balance setting retained.

- The custom white balance setting registered in this operation is effective until a new setting is registered.

Note

- The message “Custom WB error” indicates that the value is beyond the expected range. (When the flash is used on a subject in close proximity or a subject with a bright color is in the frame.) If you register this value, the  indicator turns yellow on the recording information display. You can shoot at this point, but it is recommended that you set the white balance again to get a more accurate white balance value.

To recall the custom white balance setting

WB button → Select the desired register number

- Press  on the multi-selector to display the fine adjustment screen and compensate the color to your preference.

Note

- If the flash is used when the shutter button is pressed, a custom white balance is registered with the flash light taken into account. Take pictures with the flash in later shootings.

Zooming in in one step

You can zoom in to the center of an image using the smart teleconverter (Digital zoom) and record the image.

Press the button.

- Each time you press the  button, the zoom scaling changes as follows:
Approx. $\times 1.4$ \rightarrow Approx. $\times 2$ \rightarrow Off

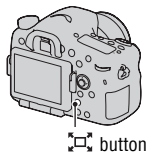

The image size is automatically set to the following regardless of the selected image size.

Zoom scaling	Image size
Approx. $\times 1.4$	M
Approx. $\times 2$	S

Notes

- The smart teleconverter is unavailable
 - When the exposure mode is set to Sweep Panorama or 3D Sweep Panorama.
 - When [Smart Telecon. Button] is set to [Focus Magnifier].
 - [Quality] is set to [RAW] or [RAW & JPEG].
 - The Smile Shutter function is set to [On].
- When the smart teleconverter is available (when in autofocus mode), [AF area] is set to [Spot].
- When the smart teleconverter is available, [Metering mode] is set to [Multi segment].
- You cannot use the smart teleconverter function with movies.

🕒 / 📷 **Selecting the drive mode**

Shooting single shot

This mode is for normal shooting.

🕒 / 📷 **(Drive) button** → 📷 **(Single Shooting)**

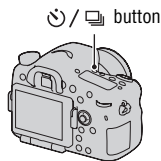

Note

- When the exposure mode is set to [Sports Action] in Scene Selection, you cannot shoot single shot.

Cont. Shooting

The camera records the images continuously.

1 🕒 / 📷 **(Drive) button** →
📷 **(Cont. Shooting)** → **Select the desired speed**

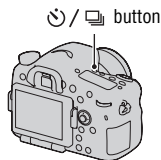

2 Adjust the focus and shoot the subject.

- When you press and hold the shutter button, the recording continues.

Shooting technique



- To shoot continuously faster, set the exposure mode to Continuous Advance Priority AE (pages 46, 101).

Notes

- When  is selected, the image recorded between the frames is displayed.
- You cannot shoot continuously when using Scene Selection modes other than [Sports Action].

Self-timer

The 10-second self-timer is convenient when the photographer appears in a photo and the 2-second self-timer is convenient to reduce the camera shake.

1  /  (**Drive**) button →  (**Self-timer**) → **Select the desired setting**

- The number after  is the number of seconds that is currently selected.

 /  button

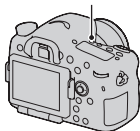

2 Adjust the focus and shoot the subject.

- When the self-timer is activated, audio signals and the self-timer lamp indicate the condition. The self-timer lamp flashes quickly and the audio signal sounds quickly right before the shooting.

To cancel the self-timer

Press the  /  (Drive) button.

Bracket: Cont./Single Bracket

Base exposure



- direction



+ direction

Bracket shooting allows you to shoot several images, each with different degrees of exposure. Specify the value of deviation (steps) from the base

exposure, and the camera shoots 3 or 5 images while automatically shifting the exposure.

- 1  (Drive) button →
BRK C (Bracket: Cont.) or
BRK S (Single Bracket) → **Select the desired bracket step and the number of images**

 button

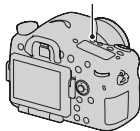

2 Adjust the focus and shoot the subject.





The base exposure is set at the first shot in the bracket.

- Press and hold the shutter button until recording stops when [Bracket: Cont.] is selected.
- Press the shutter button shot by shot when [Single Bracket] is selected.

Notes

- When the mode dial is set to M, the exposure is shifted by adjusting the shutter speed.
- When you adjust the exposure, the exposure is shifted based on the compensated value.
- The bracket cannot be used when the exposure mode is set to AUTO, AUTO+, Continuous Advance Priority AE, Sweep Panorama, 3D Sweep Panorama, or Scene Selection.
- When the flash is fired, flash bracket shooting is used to shift the amount of flash light. To shoot, press the shutter button shot by shot even when [Bracket: Cont.] is selected.

The EV scale in bracket shooting

	Ambient light* bracket 0.3 steps, 3 shots Exposure compensation 0	Flash bracket 0.7 steps, 3 shots Flash compensation -1.0
Viewfinder		
LCD monitor (When [DISP Button(Monitor)] is set to [For viewfinder])	 Shown in the top row.	 Shown in the bottom row.

* Ambient light: Any light other than the flash light that shines on the scene for an extended period of time, such as natural light, a light bulb, or a fluorescent light.

- In bracket shooting, the same number of indices as the number of recordable images is displayed on the EV scale.
- When the bracket shooting starts, the indices that indicate already recorded images start to disappear one by one.

WB bracket

Based on the selected white balance, and the color temperature/color filter, 3 images are recorded with the white balance shifted.

- 1  (Drive) button → **BRK WB (WB bracket) → Select the desired setting**

- When Lo is selected, it is shifted by 10 MK⁻¹*, and when Hi is selected, it is shifted by 20 MK⁻¹.

 button

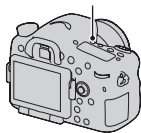

2 Adjust the focus and shoot the subject.

* MK⁻¹: a unit to indicate the color conversion quality in color temperature filters (The same value as the conventional unit, "Mired.").

DRO Bracket

3 images are recorded with the value of DRO Bracket shifted.

- 1  (Drive) button →
 (DRO Bracket) → **Select the desired setting**

- When Lo is selected, the image is recorded with DRO Lv1, Lv2, and Lv3, and when Hi is selected, the image is recorded with DRO Lv1, Lv3, and Lv5.

 button

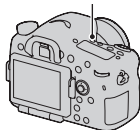

- 2 **Adjust the focus and shoot the subject.**

Remote Cdr.

You can shoot using the SHUTTER and 2SEC (the shutter is released after 2 seconds) buttons on the RMT-DSLR1 Wireless Remote Commander (sold separately). Also, refer to the operating instructions supplied with the Wireless Remote Commander.

- 1  (Drive) button →
 (Remote Cdr.)

 button

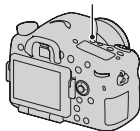

- 2 **Focus on the subject, point the transmitter of the Wireless Remote Commander to the remote sensor, and shoot the image.**

Note

- The RMT-DSLR1 Wireless Remote Commander (sold separately) cannot be used for movie recording.

The screen displayed for playback mode

Switching the screen during playback

Each time you press the DISP button, the screen changes as follows.

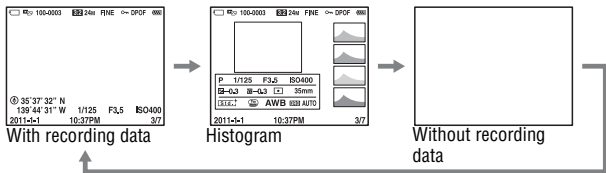

List of icons on the histogram display

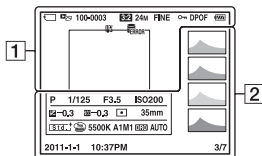

1

Display	Indication
	Memory card (27, 222)
	View mode (161)
100-0003	Folder - file number (193)
3:2 16:9	Aspect ratio of still images (172)
3D	3D Sweep Panorama (45, 99)

Display	Indication
24M 12M 6.0M 20M 10M 5.1M	Image size of still images (53)
16:9	
RAW RAW+J X.FINE FINE STD	Image quality of still images (172)
	Protect (164)
DPOF	DPOF set (198)

Display	Indication
	Remaining battery warning (28)
	Remaining battery (28)
	Database file full (213)/ Database file error (213)
	Overheating warning (16)

2

Display	Indication
	Histogram* (88)
	Exposure mode (42)
1/125	Shutter speed (105)
F3.5	Aperture (103)
ISO200	ISO sensitivity (139)
-0.3	Exposure compensation (49)
-0.3	Flash compensation (132)
	Metering mode (132)
35mm	Focal length
	Creative Style (145)
	Picture Effect (144)

Display	Indication
AWB	White balance (Auto, Preset, Color temperature, Color filter, Custom) (148)
5500K A1 M1	
D-R OFF DRO HDR HDR	D-Range Optimizer (141)/Auto HDR/Auto HDR image warning (142)
2011-1-1 10:37AM	Date of recording
3/7	File number/Number of images in the view mode

* When the image has a high-key or low-key portion, that portion is flashed on the histogram display (Luminance limit warning).

Using the playback functions

Rotating an image

- 1 Display the image you want to rotate, then press the  button.

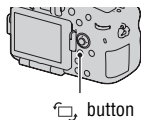

- 2 Press the center of the multi-selector.

The image is rotated counter-clockwise. When you want to do another rotation, repeat step 2.

- Once you rotate the image, the image is played back in the rotated position, even after you turn off the power.

To return to the normal playback screen

Press the  button again.

Notes

- You cannot rotate movies.
- When you copy rotated images to a computer, “PMB” contained on the CD-ROM (supplied) can display the rotated images correctly. However, the images may not be rotated depending on the software.

View Mode

Selects the unit for images to be played back.

MENU button →  **1** → **[View Mode]** → **Select the desired setting**

Folder View(Still)	Displays still images by folder.
Folder View(MP4)	Displays movies (MP4) by folder.
AVCHD View	Displays only AVCHD View movies.

Slide Show

MENU button →  **1** → **[Slide Show]** → **[Enter]**

Plays back recorded images in order (Slide Show). The slide show automatically stops after all the images have been played back.

- You can view the previous/next image with ◀/▶ on the multi-selector.
- You cannot pause the slide show.

To end in the middle of the slide show

Press the center of the multi-selector.

To choose the interval between the images in slide show

MENU button →  **1** → **[Slide Show]** → **[Interval]** → **Select the desired number of seconds**

To play back repeatedly

MENU button →  **1** → **[Slide Show]** → **[Repeat]** → **[On]**

To play back 3D-images

If you connect the camera to a 3D-compatible TV using an HDMI cable (sold separately), you can play back 3D-images recorded with the 3D Sweep Panorama mode. For details on 3D-shooting, see page 221. Also refer to the operating instructions supplied with the TV.

MENU button →  **1** → **[Slide Show]** → **[Image Type]** → **[Display 3D Only]**

Playback Display

You can set the playback orientation of images recorded in portrait orientation.

MENU button →  **2** → **[Playback Display]** → **Select the desired setting**

Scrolling panoramic images

Select a panoramic image, then press the center of the multi-selector.

- Pressing it again pauses the playback. You can scroll a panoramic image by pressing ▲/▼/◀/▶ during pause.

Note

- Scrolling playback is not available for images that were recorded with [3D Pan.: Image Size] set to [16:9].

Protecting images (Protect)

You can protect images against accidental erasure.

1 MENU button →  1 → [Protect] → [Multiple Img.]

2 Select the image you want to protect with ◀/▶ on the multi-selector, then press the center of the multi-selector.



A ✓ mark is put in the check box.

- To cancel a selection, press the center again.

3 To protect other images, repeat step 2.

- You can select all the images in the folder by selecting the bar on the left of the image index screen.

4 Press the MENU button.

5 Select [OK] with ▲, then press the center of the multi-selector.

To cancel the protection of all the images or movies

You can cancel the protection of all the images or movies by the same view mode currently displayed.

MENU button →  1 → [Protect] → [Cancel All Images], [Cancel All Movies(MP4)] or [Cancel All AVCHD view files]

Deleting images (Delete)

You can delete only unnecessary images, or all the images.

Once you have deleted an image, you cannot restore it. Check whether to delete the image or not beforehand.

Note

- Protected images cannot be deleted.

To display the desired folder

Select the bar on the left of the image index screen with the multi-selector, then select the desired folder with ▲/▼.

Delete (Multiple Img.)

1 MENU button →  1 → [Delete] → [Multiple Img.]

2 Select the images you want to delete with the multi-selector, then press the center of the multi-selector.

A ✓ mark is put in the check box.

- To cancel a selection, press the center again.



Total number

3 To delete other images, repeat step 2.

- You can select all the images in the folder by selecting the bar on the left of the image index screen.

4 Press the MENU button.

5 Select [OK] with ▲, then press the center of the multi-selector.

Deleting all the images or movies in the same view mode

You can delete all still images or movies by the same view mode currently displayed.

1 MENU button →  1 → [Delete] → [All in Folder] or [All AVCHD view files]

2 Select [Delete] with ▲ on the multi-selector, then press the center of the multi-selector.

About playback on TV

Connect the camera to a TV using an HDMI cable (sold separately) and play back images (page 57).

Notes

- Use an HDMI cable with the HDMI logo.
- Use an HDMI mini connector on one end (for the camera), and a connector suitable for connection to your TV on the other end.
- When images cannot be displayed properly, set [HDMI Resolution] in the  Setup menu to [1080p] or [1080i], according to your TV.
- Some devices may not work properly.
- Do not connect the output connector of the device with the HDMI terminal on the camera. This may cause a malfunction.

On “PhotoTV HD”

This camera is compatible with the “PhotoTV HD” standard.

By connecting Sony’s PhotoTV HD-compatible devices using an HDMI cable, a whole new world of photos can be enjoyed in breathtaking Full HD quality.

“PhotoTV HD” allows for a highly-detailed, photo-like expression of subtle textures and colors.

3D Viewing

If you connect the camera to a 3D-compatible TV using an HDMI cable (sold separately), you can play back 3D-images recorded with the 3D Sweep Panorama mode automatically. For details on 3D-shooting, see page 221. Also refer to the operating instructions supplied with the TV.

MENU button →  **1** → **[3D Viewing]**

Using “BRAVIA” Sync

By connecting the camera to a TV that supports “BRAVIA” Sync using an HDMI cable, you can operate the camera with the TV Remote Control.

1 Connect a TV that supports “BRAVIA” Sync to the camera (page 57).

The input is automatically switched and the image shot with the camera appears on the TV screen.

2 Press the SYNC MENU button on the TV Remote Control.

3 Operate with the buttons on the TV Remote Control.

The items for SYNC MENU

Slide Show	Plays back images automatically (page 162).
Single-image playback	Returns to the single-image screen.
Image Index	Switches to the image index screen.
3D Viewing	Plays back 3D-images when connected to a 3D-compatible TV.
View Mode	Switches the view mode.
Delete	Deletes images.

Notes

- The operations available are restricted when the camera is connected to a TV using an HDMI cable.
- Only TVs that support “BRAVIA” Sync can provide these operations. The SYNC MENU operations differ depending on the TV connected. For details, refer to the operating instructions supplied with the TV.
- If the camera performs unnecessary operations in response to the TV Remote Control when the camera is connected to another manufacturer’s TV using an HDMI connection, set [CTRL FOR HDMI] in the  Setup menu to [Off].





GPS setting (SLT-A77V only)

If the camera has acquired location information using the built-in GPS feature, this information is recorded in the images or movies at that location.

Using the supplied software “PMB,” you can import images recorded with location information to a computer and enjoy viewing them with a map which shows their shooting location. See “PMB Help” for details.

MENU button →  **1** → **[GPS Settings]** → **[GPS On/Off]** → **[On]**

The indicator changes according to the strength of GPS signal reception.

GPS indicators	GPS reception status
No indicator	[GPS On/Off] is set to [Off].
	Your camera cannot record the location information. Use your camera in an open area.
	Calculating the location information. Wait until the location information is recordable.
	The current location information is recordable.
	There is a problem with the GPS feature. Turn the camera off and on.

To receive a GPS signal

- Proper triangulation is not possible indoors or near tall buildings. Use your camera in an open area outside, and turn on your camera again.
- It may take several tens of seconds to several minutes to acquire the location information. You can shorten the positioning time by using GPS assist data.

Notes

- Right after you turn the camera on, it may take several tens of seconds to several minutes to acquire the location information. If you shoot images with the location information not acquired, the information is not recorded. To record the correct information, wait until the camera can receive radio signals from GPS satellites.
- During take off and landing of an airplane, turn off the camera, as you will be instructed to do by the on-board announcement.
- Use GPS in accordance with the regulations of the place or situation.
- For detailed notes on the GPS feature, see page 219.

GPS Assist Data

The time for the GPS acquiring location information can be shortened by taking in GPS assist data.

If the camera connects to the computer with the supplied “PMB” software installed, the GPS assist data can be updated automatically.

To check the state of GPS assist data

MENU button →  **1** → [GPS Settings] → [Use GPS Assist Data]

Notes

- The computer is required to connect to the Internet when updating data.
- If the term of validity of assist data has run out, the time until you can record location information cannot be shortened. It is recommended that you update the assist data regularly. The expiration date of the assist data is about 30 days.
- If [Date/Time Setup] is not set, or set time is shifted greatly, the time for the GPS acquiring location information cannot be shortened.
- The assist data service may be closed for various reasons.

To update the GPS assist data by inserting a memory card into the computer

Start up [GPS Support Tool] from  (PMB Launcher), select the memory card drive from your computer, and then update the GPS assist data. Insert the memory card that has been updated into the camera.

GPS Auto Time Cor.

Your camera maintains correct clock time by using GPS to acquire time information during starting up. The time is corrected when the power is turned off.

MENU button →  **1** → [GPS Settings] → [GPS Auto Time Cor.] → [On]

Notes

- [GPS Auto Time Cor.] is invalid if [GPS On/Off] is set to [Off].
- You must set [Date/Time Setup] on the camera before using it.

- There may be discrepancies of a few seconds.
- Depending on the area, it may not function correctly.

Setting the aspect ratio and image quality

Aspect Ratio

MENU button →  **1** → **[Aspect Ratio]** → **Select the desired ratio**

3:2	A normal ratio.
16:9	An HDTV ratio.

Note

- This item cannot be set when the exposure mode is set to Sweep Panorama or 3D Sweep Panorama.

Quality

MENU button →  **1** → **[Quality]** → **Select the desired setting**

RAW (RAW)	File format: RAW (Records using the RAW compression format.) This format does not perform any digital processing on the images. Select this format to process images on a computer for professional purposes. <ul style="list-style-type: none">• The image size is fixed to the maximum size. The image size is not displayed on the screen.
RAW+J (RAW & JPEG)	File format: RAW (Records using the RAW compression format.) + JPEG A RAW image and a JPEG image are created at the same time. This is suitable when you need 2 image files, a JPEG for viewing, and a RAW for editing. <ul style="list-style-type: none">• The image quality is fixed to [Fine] and the image size is fixed to [L].
X.FINE (Extra fine)	File format: JPEG
FINE (Fine)	The image is compressed in the JPEG format when recorded.
STD (Standard)	The compression rate is higher and the file size is smaller in the following order: [Extra fine], [Fine], and [Standard].

Note

- This item cannot be set when the exposure mode is set to Sweep Panorama or 3D Sweep Panorama.

About RAW images

You need the “Image Data Converter” software included on the CD-ROM (supplied) in order to open a RAW image recorded on this camera. With this software, a RAW image can be opened and converted to a common format, such as JPEG or TIFF, and its white balance, color saturation, contrast, etc., can be readjusted.

- The RAW format image cannot be printed using a DPOF (print) designated printer.
- You cannot set [Auto HDR] or [Picture Effect] on RAW format images.

Setting the other functions of the camera

Long Exposure NR

When you set the shutter speed to 1 second or longer (Long exposure shooting), noise reduction is turned on for the same duration that the shutter is open.

This is to reduce the grainy noise typical in a long exposure. When noise reduction is in progress, a message appears and you cannot take another picture. Select [On] to prioritize the image quality. Select [Off] to prioritize the timing of shooting.

MENU button →  2 → [Long Exposure NR] → Select the desired setting

Notes

- When the exposure mode is set to Sweep Panorama, 3D Sweep Panorama, Continuous Advance Priority AE, or continuous shooting, continuous bracketing, [Sports Action] or [Hand-held Twilight] in Scene Selection, or ISO is set to [Multi Frame Noise Reduct.], noise reduction is not performed even when it is set to [On].
- When the exposure mode is set to AUTO, AUTO+ or Scene Selection, you cannot turn off noise reduction.

High ISO NR

The camera reduces the noise that becomes more noticeable when the camera sensitivity is high. A message may be indicated during the processing and you cannot record images during this processing. Normally, set it to [Normal]. Select [High] to reduce the noise. Select [Low] to prioritize the timing of shooting.

MENU button →  2 → [High ISO NR] → Select the desired setting

Notes

- When the exposure mode is set to AUTO, AUTO+, Sweep Panorama, 3D Sweep Panorama, or Scene Selection, this item cannot be set.
- Noise reduction is not performed on RAW images.

Color Space

The way colors are represented with combinations of numbers or the range of color reproduction is called “color space.” You can change the color space, depending on your purpose.

MENU button →  **2** → **[Color Space]** → **Select the desired setting**

sRGB	This is the standard color space of the digital camera. Use sRGB in normal shooting, such as when you intend to print out the images without any modification.
AdobeRGB	This has a wide range of color reproduction. When a large part of the subject is vivid green or red, Adobe RGB is effective. <ul style="list-style-type: none"> • The file name of the image starts with “_DSC.”

Notes

- Adobe RGB is for applications or printers that support color management and DCF2.0 option color space. Using some applications or printers that do not support them may result in or print images that do not faithfully reproduce the color.
- When displaying images that were recorded with Adobe RGB on the camera or non-Adobe RGB-compliant devices, the images are displayed with low saturation.

Release w/o Lens

You can release the shutter when no lens is attached. Select this when you attach the camera on an astronomical telescope, etc.

MENU button →  **1** → **[Release w/o Lens]** → **[Enable]**

Note

- Correct metering cannot be achieved when you use lenses that do not provide a lens contact, such as the lens of an astronomical telescope. In such cases, adjust the exposure manually by checking it on the recorded image.

Grid Line

The grid line is an auxiliary line for shooting composition. You can set the grid line to on/off or select the type of grid line. The available range of movie recording is also displayed.

MENU button →  **2** → **[Grid Line]** → **Select the desired setting**

Auto Review

You can check the recorded image on the screen right after the shooting. You can change the displayed time.

MENU button →  **2** → **[Auto Review]** → **Select the desired setting**



Note

- In auto review, the image will not be displayed in the vertical position even if [Playback Display] is set to [Auto Rotate] (page 162).

Func. of AEL button

The function of the AEL button can be selected from the following 2 functions (page 132):

- Holding the locked exposure value by pressing the AEL button while the button is held down ([AEL hold]).
- Holding the locked exposure value by pressing the AEL button until the button is pressed again ([AEL toggle]).

When [ AEL hold] or [ AEL toggle] is selected, the exposure is locked in spot metering mode.

MENU button →  **3** → **[Func. of AEL button]** → **Select the desired setting**

Notes

- While the exposure value is locked,  appears on the LCD monitor and in the viewfinder. Be careful not to reset the setting.
- When [AEL toggle] is selected, be sure to press the AEL button again to release the lock.

To assign another function to the AEL button

You can assign one of the following functions to the AEL button in addition to the AEL function:

Exposure Comp./Drive Mode/Flash Mode/AF area/Face Detection/Smile Shutter/ISO/Metering Mode/Flash Comp./White Balance/DRO/Auto HDR/Creative Style/Picture Effect/Image Size/Quality/AF/MF Control Hold/AF/MF Control Toggle/Object Tracking/AF lock/Aperture Preview/Shot. Result Preview/Smart Telecon./Focus Magnifier/Memory

ISO Button, AF/MF button

You can also assign another function to the ISO button or AF/MF button. The functions available are the same as those of [Func. of AEL button] (page 176).

MENU button → **⚙ 3** → **[ISO Button] or [AF/MF button]** → **Select the desired setting**

Preview Button

You can check the approximate blurring of the background of the subject before shooting.

MENU button → **⚙ 3** → **[Preview Button]** → **Select the desired setting**

Shot. Result Preview	The aperture is narrowed to match the selected aperture value and you can check the blurring. The shutter speed value is also reflected.
Aperture Preview	The aperture is narrowed to match the selected aperture value and you can check the blurring.

Electronic Front Curtain Shutter

The electronic front curtain shutter function shortens the time lag between shutter releases.

MENU button → **⚙ 5** → **[Front Curtain Shutter]** → **Select the desired setting**

Notes

- When you shoot at high shutter speeds with a large diameter lens attached, the ghosting of a blurred area may occur, depending on the subject or shooting conditions. In such cases, set this item to [Off].
- When a Konica Minolta lens is used, set this item to [Off]. If you set this item to [On], the correct exposure will not be set or the image brightness will be uneven.

LCD Brightness

The brightness of the LCD monitor is automatically adjusted to the surrounding lighting conditions using the light sensor (page 20). You can set the brightness of the LCD monitor manually.

MENU button →  **1** → **[LCD Brightness]** → **Select the desired setting**

Notes

- When it is set to [Auto], do not cover the light sensor with your hand and so on.
- When using the camera with the AC-PW10AM AC Adaptor (sold separately), the brightness of the LCD monitor is always set to the brightest setting even if you select [Auto].

Viewfinder Bright.

The brightness of the viewfinder is automatically adjusted to the lighting conditions of the subject. You can set the brightness of the viewfinder manually.

MENU button →  **1** → **[Viewfinder Bright.]** → **[Manual]** → **Select the desired setting**

Note

- When using the camera with the AC-PW10AM AC Adaptor (sold separately), the brightness of the viewfinder is always set to the brightest setting even if you select [Auto].

Power Save

You can set different time intervals for the camera to switch to power save mode (Power Save). Pressing the shutter button halfway down returns the camera to the shooting mode.

MENU button →  **1** → **[Power Save]** → **Select the desired time**

Note

- The camera does not turn to power save mode when the camera is connected to a TV or the drive mode is set to [Remote Cdr.].

FINDER/LCD Setting

You can disable the automatic switching of the LCD monitor and the viewfinder and enable only the FINDER/LCD button to switch them.

MENU button →  **1** → **[FINDER/LCD Setting]** → **[Manual]**

Lens compensation

You can automatically compensate the following characteristics: light fall-off at the edges, chromatic aberration, and distortion (only for automatic compensation compliant lenses). For further information on automatic compensation compliant lenses, visit the Sony web site in your area, or consult your Sony dealer or local authorized Sony service facility.

Lens Comp.: Peripheral Shading

Compensates for the shaded corners of the screen caused by certain lens characteristics. This item is set to [Auto] in the default settings.

MENU button → **⚙ 5** → **[Lens Comp.: Shading]** → **Select the desired setting**

Lens Comp.: Chromatic Aberration

Reduces the color deviation at the corners of the screen caused by certain lens characteristics. This item is set to [Auto] in the default settings.

MENU button → **⚙ 5** → **[Lens Comp.: Chro. Aber.]** → **Select the desired setting**

Lens Comp.: Distortion

Compensates for the distortion of the screen caused by certain lens characteristics. This item is set to [Off] in the default settings.

MENU button → **⚙ 5** → **[Lens Comp.: Distortion]** → **Select the desired setting**

Setting the method for recording on a memory card

Format

Note that formatting irrevocably erases all data on a memory card, including protected images.

MENU button →  **1** → **[Format]** → **[Enter]**

Notes

- During the format, the access lamp lights up. Do not eject the memory card while the lamp is lit.
- Format the memory card using the camera. If you format it on a computer, the memory card may not be usable with the camera, depending on the format type used.
- Formatting may take several minutes depending on the memory card.
- When the remaining battery time is 1 percent or less, you cannot format memory cards.

File Number

MENU button →  **1** → **[File Number]** → **Select the desired setting**

Series	The camera does not reset numbers and assigns numbers to files in sequence until the number reaches “9999.”
Reset	The camera resets numbers in the following cases and assigns numbers to files from “0001.” When the recording folder contains a file, a number one higher than the largest number is assigned. <ul style="list-style-type: none">– When the folder format is changed.– When all the images in the folder are deleted.– When the memory card is replaced.– When the memory card is formatted.

Folder Name

The recorded still images are stored in automatically-created folders in the DCIM folder of the memory card.

MENU button →  **1** → **[Folder Name]** → **Select the desired setting**

Standard Form	The folder name format is as follows: folder number + MSDCF. Example: 100MSDCF
Date Form	The folder name format is as follows: folder number + Y (the last digit)/MM/DD. Example: 10010405 (Folder name: 100, date: 2011/04/05)

Note

- The MP4 movie folder form is fixed as “folder number + ANV01.”

Select REC Folder

When a standard form folder is selected and there are 2 or more folders, you can select the recording folder to be used to record images.

MENU button →  **1** → **[Select REC Folder]** → **Select the desired folder**

Note

- You cannot select the folder when you select the setting [Date Form].

New Folder

You can create a folder in a memory card for recording images.

A new folder is created with a number incremented one higher than the largest number currently used, and the folder becomes the current recording folder. A folder for still images and a folder for MP4 movies are created at the same time.

MENU button →  **1** → **[New Folder]**

Notes

- When you insert a memory card that was used with other equipment into the camera and shoot images, a new folder may be automatically created.
- Up to 4 000 images can be stored in a folder. When the folder capacity is exceeded, a new folder is created automatically.

Recover Image DB

When inconsistencies are found in the image database file, caused by processing images on computers, etc., images on the memory card will not be played back in this form. If this happens, the camera repairs the file.

MENU button →  **1** → **[Recover Image DB]** → **[Enter]**

Note





- Use a sufficiently charged battery. Low battery power during repairing can cause damage to data.

Upload Settings

Sets whether or not you use the upload function when using an Eye-Fi card (commercially available). This item appears when an Eye-Fi card is inserted in the camera.

MENU button →  **2** → **[Upload Settings]** → **Select the desired setting**



The status indicators in communication

	Standby. No images are to be sent.
	Upload standby.
	Connecting.
	Uploading.
	Error.

Notes

- Before using an Eye-Fi card, set up the wireless LAN access point and forwarding destination. For details, refer to the operating manual supplied with the Eye-Fi card.
- Eye-Fi cards are sold in the U.S.A, Canada, Japan, and some countries in the EU (as of March in 2011).
- For more information, please contact the manufacturer or vendor directly.
- Eye-Fi cards can be used only in the countries/regions where they were purchased. Use Eye-Fi cards in accordance with the law of the countries/regions where you purchased the card.
- Eye-Fi cards include a wireless LAN function. Do not insert any Eye-Fi cards in the camera when it is prohibited to do so, such as on an airplane. If there is an Eye-Fi

card inserted in the camera, set [Upload Settings] to [Off].  OFF is displayed on the screen when [Upload Settings] is set to [Off].

- When you use a brand-new Eye-Fi card for the first time, copy the install file of Eye-Fi manager recorded on the card to your computer before formatting the card.
- Use an Eye-Fi card after updating the firmware to the latest version. For details, refer to the manual that comes with the Eye-Fi card.
- The power save function of the camera does not work while it is uploading images.
- If  (error) is displayed, remove the memory card and reinsert it, or turn off then turn on the power again. If  appears again, the Eye-Fi card may be damaged.
- Wi-Fi network communication may be influenced by other communication devices. If the communication status is poor, move closer to the access point of the Wi-Fi network.
- For details on the file types that can be uploaded, refer to the operating instructions supplied with the Eye-Fi card.
- If you upload an image that was recorded with [GPS On/Off] set to [On], the location information of the image may be made available to a third party. To prevent this, set [GPS On/Off] to [Off] (page 169) (SLT-A77V only).
- This product does not support the Eye-Fi “Endless Memory Mode.” Make sure that Eye-Fi cards that you insert into this product have “Endless Memory Mode” turned off.

Registering your own settings

You can register 3 combinations of frequently used modes and settings in the memory. You can recall the registered settings with the mode dial.

1 Put the camera on the setting you want to register.

2 MENU button →  3 → [Memory]

3 Select the number you want to register with ◀/▶ on the multi-selector, then press the center of the multi-selector.

You can change the settings after you have registered them.

Items that can be registered

Exposure mode, aperture, shutter speed, drive mode, ISO, white balance, exposure compensation, metering mode, DRO/Auto HDR, Creative Style, flash mode, flash compensation, Face Detection, Smile Detection Sensitivity, object tracking, Picture Effect, the position of the local AF area, and all of the  Still shooting menu items (pages 62 to 63)

To recall the saved settings

Set the mode dial to MR and select the number you want to recall. When you want to select another number, press the Fn button, then select the desired number.

To change the saved settings

After recalling the setting, put the camera on the setting you want to register, then register the setting on the same number again.

Notes

- You cannot register the Program Shift and Manual Shift settings.
- The actual setting will not correspond to the positions of the dials on the camera. Refer to the information displayed on the LCD monitor when you take pictures.

Resetting to the default

You can reset the main functions of the camera.

MENU button →  **3** → **[Initialize]** → **Select the desired setting**
→ **[OK]**

The items to be reset are as follows.

Shooting functions (Reset Default/Rec mode reset)

Items	Reset to
Exposure compensation (49)	±0.0
Drive mode (51, 154)	Single Shooting
Flash Mode (47, 135)	Fill-flash (differs based on whether the built-in flash is open or not)
AF area (119)	Wide
Object Tracking (121)	On
Face Detection (127)	On (Regist. Faces)
Smile Shutter (129)	Off
ISO (139)	AUTO
Metering Mode (132)	Multi segment
Flash Comp. (132)	±0.0
White Balance (148)	AWB (Auto white balance)
Color Temp./Color Filter (150)	5500K, Color Filter 0
Custom white balance (150)	5500K
DRO/Auto HDR (141)	D-Range Optimizer: Auto
Creative Style (145)	1/Standard
Picture Effect (144)	Off
Scene Selection (44, 97)	Portrait
Movie (112)	P

Still shooting menu (Reset Default/Rec mode reset)

Items	Reset to
Image Size (53)	L:24M
Aspect Ratio (172)	3:2
Quality (172)	Fine



Items	Reset to
Panorama: Size (53)	Standard
Panorama: Direction (101)	Right
3D Pan.: Image Size (53)	Standard
3D Pan.: Direction (101)	Right
Long Exposure NR (174)	On
High ISO NR (174)	Normal
Flash control (133)	ADI flash
Power ratio (134)	1/1
AF Illuminator (120)	Auto
Color Space (175)	sRGB
SteadyShot (94)	On
Exposure step (63)	0.3 EV
AF-A setup (125)	AF-A
Priority setup (63)	AF
AF w/ shutter (63)	On

Movie shooting menu (Reset Default/Rec mode reset)

Items	Reset to
File Format (113)	AVCHD 60i/60p, AVCHD 50i/50p
Record Setting (114)	60i 17M(FH), 50i 17M(FH)
Audio Recording (115)	On
Wind Noise Reduct. (115)	Off
SteadyShot (94)	On

Custom menu (Reset Default/Custom reset)

Items	Reset to
Eye-Start AF (86)	Off
FINDER/LCD Setting (179)	Auto
Red Eye Reduction (64)	Off
Release w/o Lens (175)	Disable
Auto+ Cont. Shooting (96)	Auto
Auto+ Image Extract. (96)	Auto

Items	Reset to
Grid Line (176)	Off
Auto Review (176)	Off
DISP Button(Monitor) (87)	Display All Info./No Disp. Info./Level/ Histogram
DISP Button(Finder) (87)	No Disp. Info./Level/Histogram
Peaking Level (124)	Off
Peaking Color (124)	White
Live View Display (89)	Setting Effect ON
Func. of AEL button (176)	AEL hold
ISO Button (177)	ISO
AF/MF button (177)	AF/MF Control Hold
Preview Button (177)	Shot. Result Preview
Focus Hold Button (66)	Focus Hold
Smart Telecon. Button (124, 153)	Smart Telecon.
Ctrl dial setup (66)	 SS  F/no.
Dial exp.comp (50)	Off
Exp.comp.set (66)	Ambient only
Bracket order (66)	0 → - → +
AF drive speed (66)	Fast
Lens Comp.: Shading (180)	Auto
Lens Comp.: Chro. Aber. (180)	Auto
Lens Comp.: Distortion (180)	Off
Front Curtain Shutter (177)	On

Playback menu (Reset Default)

Items	Reset to
View Mode (161)	Folder View(Still)
Slide Show – Interval (162)	3 sec
Slide Show – Repeat (162)	Off
Specify Printing – Date Imprint (198)	Off
Volume Settings (67)	2
Playback Display (162)	Auto Rotate

Memory Card Tool menu (Reset Default)

Items	Reset to
File Number (181)	Series
Folder Name (181)	Standard Form

Setup menu (Reset Default)

Items	Reset to
Menu start (68)	Top
LCD Brightness (178)	Auto
Viewfinder Bright. (178)	Auto
GPS Settings – GPS On/Off (169) (SLT-A77V only)	Off
GPS Settings – GPS Auto Time Cor. (170) (SLT-A77V only)	–
Power Save (179)	1 Min
HDMI Resolution (167)	Auto
CTRL FOR HDMI (167)	On
Upload Settings (183)	On
USB Connection (191)	Auto
Audio signals (69)	On
Mode Dial Guide (69)	Off
Demo Mode (69)	Off
Delete confirm. (69)	“Cancel” first
AF Micro Adj. (121)	Off

Others (Reset Default)

Items	Reset to
Recording information display (LCD monitor) (52)	Display All Info.
Recording information display (Viewfinder) (52)	Level
Playback display (159)	Single-image screen (with recording information)

Confirming the version of the camera

Displays the version of your camera. Confirm the version when a firmware update is released.

MENU button →  **3** → **[Version]**

Note

- An update can be performed only when the battery level is  (3 remaining battery icons) or more. We recommend that you use a sufficient battery or the AC-PW10AM AC Adaptor (sold separately).

Connecting the camera to the computer

Setting the USB connection

Selects the method used for a USB connection when the camera is connected to a computer or a USB device with a USB cable.

MENU button →  **2** → **[USB Connection]** → **Select the desired setting**

Auto	Establishes a Mass Storage or MTP connection automatically, in accordance with a computer or other USB devices to be connected. Windows 7 computers are connected in MTP, and its unique functions are enabled to use.
MTP	Establishes an MTP connection between the camera, a computer, and other USB devices. Windows 7 computers are connected in MTP, and its unique functions are enabled to use. In the case of other computers (Windows Vista/XP, Mac OS X), the AutoPlay Wizard appears, and the still images in the recording folder on the camera are imported to the computer.
Mass Storage	Establishes a Mass Storage connection between the camera, a computer, and other USB devices. Standard mode.

Notes

- When this item is set to [Auto], it may take some time to establish a connection.
 - If Device Stage* is not displayed with Windows 7, set this item to [Auto].
- * Device Stage is a menu screen used to manage connected devices, such as a camera (Function of Windows 7).

Connecting to the computer

- 1** Insert a sufficiently charged battery pack into the camera, or connect the camera to a wall outlet (wall socket) using the AC-PW10AM AC Adaptor (sold separately).

2 Turn on the camera and the computer.

3 Check that [USB Connection] in 2 is set to [Mass Storage].

4 Connect the camera to your computer.

- When a USB connection is established for the first time, your computer automatically runs a program to recognize the camera. Wait for a while.

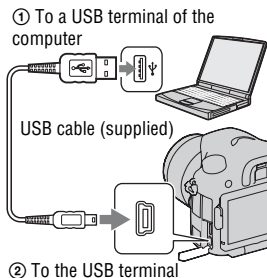

Importing images to the computer (Windows)

“PMB” allows you to easily import images.

For details on “PMB” functions, see the “PMB Help.”

Importing images to the computer without using “PMB”

When the AutoPlay Wizard appears after making a USB connection between the camera and a computer, click [Open folder to view files] → [OK] → [DCIM] or [MP_ROOT] → copy the desired images to the computer.

File name

Folder	The type of file	File name
DCIM folder	JPEG file	DSC0□□□□.JPG
	JPEG file (Adobe RGB)	_DSC□□□□.JPG
	RAW file	DSC0□□□□.ARW
	RAW file (Adobe RGB)	_DSC□□□□.ARW
MP_ROOT folder	MP4 file (1440 × 1080 12M)	MAH0□□□□.MP4
	MP4 file (VGA 3M)	MAQ0□□□□.MP4

- □□□□ (file number) stands for any number within the range of 0001 to 9999.
- When [Quality] is set to [RAW & JPEG], the numerical portions of the name of a RAW data file and its corresponding JPEG file are the same.

Notes

- For operations such as importing AVCHD View movies to the computer, use “PMB.”
- Use “PMB” to import the movies with GPS location information to a computer (SLT-A77V only).
- When the camera is connected to the computer, if you operate AVCHD View movies or folders from the connected computer, images may be damaged or cannot be played. Do not delete or copy AVCHD View movies on the memory card from the computer. Sony is not held liable for consequences resulting from such operations via the computer.

Importing images to the computer (Macintosh)

1 Connect the camera to your Macintosh computer first. Double-click the newly recognized icon on the desktop → the folder where the images you want to import are stored.

2 Drag and drop the image files to the hard disk icon.

The image files are copied to the hard disk.

3 Double-click the hard disk icon → the desired image file in the folder containing the copied files.

The image is displayed.

Note

- Use “iMovie” bundled with a Macintosh computer to import or operate AVCHD View movies.

Deleting the USB connection

Perform the procedures from step 1 to 3 below before:

- Disconnecting the USB cable.
- Removing the memory card.
- Turning off the camera.

1 Double-click the disconnect icon on the taskbar.

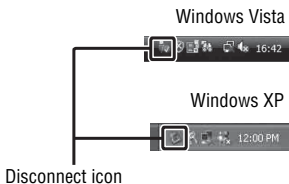

2 Click (USB Mass Storage Device) → [Stop].

3 Confirm the device on the confirmation window, then click [OK].

Note

- Drag and drop the icon of the memory card or the drive icon to the “Trash” icon beforehand when you use a Macintosh computer, and the camera is disconnected from the computer.

Creating a movie disc

You can create a disc from AVCHD View movies recorded on the camera.

- Movies recorded with the [60p 28M(PS)]/[50p 28M(PS)], [60i 24M(FX)]/[50i 24M(FX)] or [24p 24M(FX)]/[25p 24M(FX)] setting in [Record Setting] are converted by “PMB” in order to create an AVCHD disc. This conversion can take a long time. Also, you cannot create a disc with the original image quality. If you want to keep the original image quality, you must store your movies on a Blu-ray disc (page 196).

Creating an AVCHD format disc

You can create a high definition image quality (HD) AVCHD format disc from AVCHD View movies imported to a computer using the supplied software “PMB.”

1 Select the AVCHD View movies you want to write on “PMB.”

2 Click  (Create Discs) to select [Create AVCHD Format Discs (HD)].

The screen used for creating a disc appears.

- For details, see “PMB Help.”

Notes

- Install “PMB” beforehand.
- Still images and MP4 movie files cannot be recorded on the AVCHD format disc.
- It may take a long time to create a disc.

Playing back AVCHD format disc on a computer

You can play back AVCHD format discs using “Player for AVCHD” that is installed together with “PMB.”

To start the software, click on [Start] → [All Programs] → [PMB] → [PMB Launcher] → [View] → [Player for AVCHD].

For detailed operations, see the Help for “Player for AVCHD.”

Note

- Movies may not be played smoothly depending on the computer environment.

Creating a Blu-ray disc

You can create a Blu-ray disc with AVCHD View movies previously imported to a computer. Your computer must support the creation of Blu-ray discs.

BD-R (non-rewritable) and BD-RE (rewritable) media can be used to create Blu-ray discs. You cannot add contents to either type of disc once it has been created.

Click [BD Add-on Software] on the installation screen of “PMB,” and install this plug-in according to the on-screen instructions.

Connect your computer to the Internet when you install [BD Add-on Software].

See “PMB Help” for details.

Note

- When movies recorded with the [60p 28M(PS)]/[50p 28M(PS)] setting are copied to a Blu-ray disc using “PMB,” those movies can be played back only on devices that are compatible with the AVCHD Ver 2.0 format.

Creating a standard definition image quality (STD) disc

You can create a standard definition image quality (STD) disc from AVCHD View movies imported to a computer using supplied software “PMB.”

1 Select the AVCHD View movies you want to write on “PMB.”

2 Click (Create Discs) to select [Create DVD-Video Format Discs (STD)].

The screen used for creating a disc appears.

- For details, see “PMB Help.”

Notes

- Install “PMB” beforehand.
- MP4 movie files cannot be recorded on a disc.
- It will take a longer time to create a disc because AVCHD View movies are converted to standard definition image quality (STD) movies.
- An Internet connection environment is required when creating a DVD-Video (STD) disc for the first time.

Discs you can use with “PMB”

You can use 12 cm discs of following type with “PMB.” For Blu-ray disc, see page 196.

Disc type	Features
DVD-R/DVD+R/DVD+R DL	Unrewritable
DVD-RW/DVD+RW	Rewritable

- Always maintain your PlayStation®3 to use the latest version of the PlayStation®3 system software.
- The PlayStation®3 may not be available in some countries/regions.

Specifying DPOF

Using the camera, you can specify the still images before you print images at a shop or with your printer. Follow the procedure below.

DPOF specifications are left with images after printing. It is recommended that you unselect them after printing.

1 MENU button →  **1** → **[Specify Printing]** → **[DPOF Setup]**
→ **[Multiple Img.]**

2 Select the image with   **on the multi-selector.**

3 Check the  **mark by pressing the center of the multi-selector.**

- To unselect DPOF, select the image again, then press the center of the multi-selector.
-

4 Press the MENU button.

5 Select [OK] with  **, then press the center of the multi-selector.**

Notes

- You cannot specify DPOF on RAW data files.
- You cannot specify the number of images to be printed.

Date Imprint

You can date images when printing them. The position of the date (inside or outside the image, character size, etc.) depends on your printer.

MENU button →  **1** → **[Specify Printing]** → **[Date Imprint]** → **[On]**

Note

- This function may not be provided, depending on the printer.

Cleaning the camera and a lens

Cleaning the camera

- Do not touch the inside of the camera, such as lens contacts, or the mirror. Since dust on the mirror or around the mirror may affect the images or the performance of the camera, blow the dust away using a commercially available blower*. For details on cleaning the image sensor, see the next page.

* Do not use a spray blower. Using one may cause a malfunction.

- Clean the camera surface with a soft cloth slightly moistened with water, then wipe the surface with a dry cloth. Do not use the following as they may damage the finish or the casing.
 - Chemical products such as thinner, benzene, alcohol, disposable cloths, insect repellent, sunscreen or insecticide, etc.
 - Do not touch the camera with the above on your hand.
 - Do not leave the camera in contact with rubber or vinyl for a long time.

Cleaning the lens

- Do not use a cleaning solution containing organic solvents, such as thinner, or benzene.
- When cleaning the lens surface, remove dust using a commercially available blower. In case of dust that sticks to the surface, wipe it off with a soft cloth or tissue paper slightly moistened with lens cleaning solution. Wipe in a spiral pattern from the center to the outside. Do not spray lens cleaning solution directly onto the lens surface.

Cleaning the image sensor

If dust or debris enters the camera and adheres to the image sensor (the part that acts as the film), it may appear as dark spots on the photo image, depending on the shooting environment. If there is dust on the image sensor, clean the image sensor following the steps below.

Notes

- Cleaning cannot be performed when the battery level is 50% or less.
- The camera starts beeping if the battery pack becomes low during cleaning. Stop cleaning immediately and turn the camera off. The use of an AC-PW10AM AC Adaptor (sold separately) is recommended.
- The cleaning should be completed quickly.
- Do not use a spray blower because it may scatter water droplets inside the camera body.

Cleaning the image sensor automatically using the cleaning mode of the camera

1 Confirm that the battery is fully charged (page 28).

2 Press the MENU button, then select **2** with **◀/▶** on the multi-selector.

MENU button

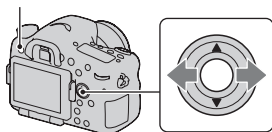

3 Select [Cleaning Mode] with **▲/▼**, then press the center of the multi-selector.

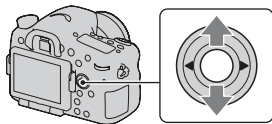

4 Select [Enter] with ▲, and press the center of the multi-selector.

The image sensor vibrates for a short time, and eliminates dust from the sensor.

5 Turn off the camera.

Cleaning the image sensor using a blower

If another cleaning is needed after using the cleaning mode, clean the image sensor using a blower following the steps below.

1 Perform the cleaning operation described in steps 1 to 4 of “Cleaning the image sensor automatically using the cleaning mode of the camera.”

2 Detach the lens (page 31).

3 Push the ▼ mark on the mirror lock lever to lift up the mirror.

- Be careful not to touch the surface of the mirror.

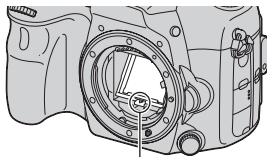

Mirror lock lever

4 Use the blower to clean the image sensor surface and the surrounding area.

- Do not touch the image sensor with the tip of the blower and do not put the tip of a blower into the cavity beyond the mount.
- Hold the camera's face downward to prevent the dust from resettling in the camera. Complete the cleaning quickly.
- Also clean the back of the mirror using a blower.

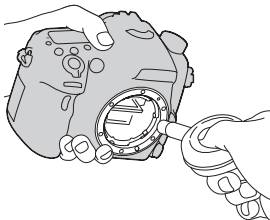

5 After the cleaning is finished, lower the mirror with a finger until it clicks.

- Lower the frame of the mirror back down with a finger. Be careful not to touch the surface of the mirror.
- Lower the mirror down until it locks firmly.

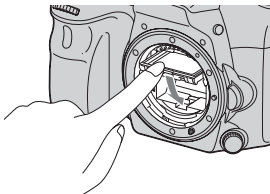

6 Attach the lens and turn the camera off.

- Confirm that the mirror is locked down firmly when you attach the lens.

Notes

- After the cleaning is finished, confirm that the mirror is locked down firmly when you attach the lens. Otherwise, the lens may be scratched or this may be the cause of additional trouble. Also, if the mirror is not locked down firmly, the autofocus does not work during shooting.
- You cannot shoot while the mirror is lifted up.

Troubleshooting

If you experience trouble with your camera, try the following solutions. Check the items on pages 203 to 211. Consult your Sony dealer or local authorized Sony service facility.

❶ Check the following items.

❷ Remove the battery pack, and insert the battery pack again after about 1 minute, and turn on the power.

❸ Reset the settings (page 186).

❹ Consult your Sony dealer or local authorized Sony service facility.

Battery pack and power

The battery pack cannot be installed.

- As you insert the battery pack, use the tip of the battery pack to push the lock lever (page 27).
- You can use an NP-FM500H battery pack only. Make sure that the battery is NP-FM500H.

The remaining battery indicator is incorrect, or sufficient remaining battery indicator is displayed but the power runs out too quickly. Cannot turn on the camera.

- This phenomenon occurs when you use the camera in an extremely hot or cold location (page 214).
- The battery pack is discharged. Install a charged battery pack (page 25).
- The battery pack is dead (page 225). Replace it with a new one.
- Install the battery pack correctly (page 27).

The power turns off suddenly.

- If you do not operate the camera for given period of time, the camera turns to power saving mode and nearly shuts down. To cancel the power save,

operate the camera, such as pressing the shutter button halfway down (page 179).

The CHARGE lamp flashes when charging the battery pack.

- You can use an NP-FM500H battery pack only. Make sure that the battery is NP-FM500H.
- If you charge a battery pack that has not been used for a long time, the CHARGE lamp may flash.
- The CHARGE lamp flashes in 2 ways, fast (about 0.15-second intervals) and slow (about 1.5-second intervals). If it is flashing fast, remove the battery pack and reattach the same battery pack securely. If the CHARGE lamp flashes fast again, it suggests that there is something wrong with the battery pack. Slow flashing indicates that charging is suspended because the ambient temperature is outside the suitable range for charging the battery pack. Charging will resume and the CHARGE lamp will be lit when the ambient temperature returns to within the suitable temperature. Charge the battery pack under the suitable temperatures between 10°C and 30°C (50°F and 86°F).

Shooting images

Nothing is displayed on the LCD monitor in viewfinder mode when the power is turned on.

- If you do not operate the camera for given period of time, the camera turns to power saving mode and nearly shuts down. To cancel the power save, operate the camera, such as pressing the shutter button halfway down (page 179).

The image is not clear in the viewfinder.

- Adjust the diopter scale properly using the diopter-adjustment dial (page 35).

No images in the viewfinder.

- [FINDER/LCD Setting] is set to [Manual]. Press the FINDER/LCD button (page 179).
- Move your eye a little closer to the viewfinder.

The shutter does not release.

- You are using a memory card with a write-protect switch, and the switch is set to the LOCK position. Set the switch to the recording position.
- Check the free capacity of the memory card.
- You cannot record images while charging the built-in flash (pages 47, 135).
- In autofocus mode, the shutter cannot be released when the subject is out of focus.
- The lens is not attached properly. Attach the lens properly (page 30).
- When the camera is attached to another device, such as an astronomical telescope, set [Release w/o Lens] to [Enable] (page 175).
- The subject may require special focusing (page 118). Use the focus-lock or manual focus function (pages 119, 123).

Recording takes a long time.

- The noise reduction function is turned on (page 174). This is not a malfunction.
- You are shooting in RAW mode (page 172). Since the RAW data file is large, the RAW mode shooting may take time.
- The Auto HDR is processing an image (page 141).

The same image is shot several times.

- The drive mode is set to [Cont. Shooting] or [Bracket: Cont.]. Set it to [Single Shooting] (pages 51, 154).
- The exposure mode is set to Continuous Advance Priority AE (pages 46, 101).
- The exposure mode is set to AUTO+ and [Auto+ Image Extract.] is set to [Off] (page 96).

The image is out of focus.

- The subject is too close. Check the minimum focal distance of the lens.
- You are shooting in manual focus mode. Set the focus mode dial to positions other than MF (page 116).
- When the focus mode switch is equipped with the lens, set it to AF.
- Ambient light is insufficient.

Eye-Start AF does not work.

- Set [Eye-Start AF] to [On] (page 86).
- Press the shutter button halfway down.

The flash does not work.

- The flash mode is set to [Autoflash]. If you want to make sure the flash fires without fail, set the flash mode to [Fill-flash] (pages 47, 135).
-

The flash takes too long to recharge.

- The flash has been fired in succession in a short period. When the flash has been fired in succession, the recharging process may take longer than usual to avoid overheating of the camera.
-

A picture taken with the flash is too dark.

- If the subject is beyond the flash range (the distance that the flash can reach), the pictures will be dark because the flash light does not reach the subject. If the ISO is changed, the flash range also changes with it. Check the flash range in “Specifications.”
-

The date and time are recorded incorrectly.

- Set the correct date and time (page 33).
 - The area selected with [Area Setting] is different from the actual area. Set up [Area Setting] again (page 33).
-

The aperture value and/or shutter speed flashes when you press the shutter button halfway down.

- Since the subject is too bright or too dark, it is beyond the available range of the camera. Adjust the setting again.
-

The image is whitish (Flare).**Blurring of light appears on the image (Ghosting).**

- The picture was taken under a strong light source, and excessive light has entered the lens. Attach a lens hood.
-

The corners of the picture are too dark.

- If any filter or hood is used, take it off and try shooting again. Depending on the thickness of the filter and improper attachment of the hood, the filter or the hood may partially appear in the image. The optical properties of some lenses may cause the periphery of the image to appear too dark (insufficient light). You may compensate for this phenomenon with [Lens Comp.: Shading] (page 180).

The eyes of the subject come out red.

- Activate the red eye reduction function (page 64).
- Get close to the subject, and shoot the subject within the flash range using the flash. Check the flash range in “Specifications.”

Dots appear and remain on the LCD monitor.

- This is not a malfunction. These dots are not recorded (page 15).

The image is blurred.

- The picture was taken in a dark location without the flash, resulting in camera shake. The use of a tripod or the flash is recommended (pages 47, 95, 135).

The EV scale ◀ ▶ is flashing on the LCD monitor or in the viewfinder.

- The subject is too bright or too dark for the metering range of the camera.

Viewing images

Your camera cannot play back images.

- The folder/file name has been changed on your computer (page 191).
- When an image file has been processed by a computer or when the image file was recorded using a model other than that of your camera, playback on your camera is not guaranteed.
- Use “PMB” to play images stored on a PC with this camera.
- The camera is in USB mode. Delete the USB connection (page 194).

Deleting images

Your camera cannot delete an image.

- Cancel the protection (page 164).

You have deleted an image by mistake.

- Once you have deleted an image, you cannot restore it. We recommend that you protect images that you do not want to delete (page 164).

GPS (SLT-A77V only)

The camera is not receiving a GPS signal.

- Set [GPS On/Off] to [On] (page 169).
- Your camera may not be able to receive radio signals from GPS satellites because of obstructions.
- To triangulate the location information correctly, bring your camera to an open area, and turn on the camera again.

Excessive error in location information.

- The margin of error can be up to several-hundred meters depending on surrounding buildings, weak GPS signals, etc.

It takes time to triangulate although GPS assist data has been taken in.

- [Date/Time Setup] is not set, or set time is shifted greatly. Set the date and time correctly (page 33).
- The term of validity of assist data has expired. Update the GPS assist data (page 170).
- As the positions of GPS satellites vary constantly, it may take longer to determine the location or the receiver may not be able to determine the location at all, depending on the location and time you use the camera.
- “GPS” is a system for determining geographic location by triangulating radio signals from GPS satellites. Avoid using the camera in places where radio signals are blocked or reflected, such as a shadowy place surrounded by buildings or trees, etc. Use the camera in open sky environments.

The location information has not been recorded.

- Use “PMB” to import the movies with GPS location information to your computer.

Computers

You do not know if the OS of your computer is compatible with the camera.

- Check “Using with your computer” (page 71).

Your computer does not recognize your camera.

- Check that the camera is turned on.

- When the battery level is low, install the charged battery pack (page 25), or use the AC Adaptor (sold separately).
- Use the USB cable (supplied) (page 191).
- Disconnect the USB cable, and connect it again firmly.
- Disconnect all equipment other than the camera, the keyboard and the mouse from the USB jacks of your computer.
- Connect the camera directly to your computer without passing through a USB hub or other devices (page 191).

You cannot copy images.

- Make the USB connection by properly connecting the camera with your computer (page 191).
- Follow the designated copy procedure for your OS (page 192).
- When you shoot images with a memory card formatted by a computer, you may not be able to copy the images to a computer. Shoot using a memory card formatted by your camera (page 181).

The image cannot be played back on a computer.

- If you are using “PMB,” refer to the “PMB Help.”
- Consult the computer or software manufacturer.

After making a USB connection, “PMB” does not start automatically.

- Make the USB connection after the computer is turned on (page 191).

Memory card

Cannot insert a memory card.

- Insertion direction of the memory card is wrong. Insert it in the correct direction (page 27).

Cannot record on a memory card.

- The memory card is full. Delete unnecessary images (pages 40, 165).
- An unusable memory card is inserted (pages 29, 222).

You have formatted a memory card by mistake.

- All the data on the memory card are deleted by formatting. You cannot restore it.

Printing

Cannot print images.

- RAW images cannot be printed. To print RAW images first, convert them to JPEG images using “Image Data Converter” on the supplied CD-ROM.

The color of the image is strange.

- When you print the images recorded in Adobe RGB mode using sRGB printers that are not compatible with Adobe RGB (DCF2.0/Exif2.21), the images are printed at a lower intensity level (page 175).

Images are printed with both edges cut off.

- Depending on your printer, the left, right, top, and bottom edges of the image may be cut off. Especially when you print an image shot with the aspect ratio set to [16:9], the lateral end of the image may be cut off.
- When printing images using your own printer, cancel the trimming or borderless settings. Consult the printer manufacturer as to whether the printer provides these functions or not.
- When having images printed at a digital print shop, ask the shop whether they can print the images without cutting off both edges.

Cannot print images with the date.

- Using “PMB,” you can print images with date (page 75).
- This camera does not have a feature for superimposing dates on images. However, because the images shot with the camera include information on the recording date, you can print images with the date superimposed if the printer or the software can recognize Exif information. For compatibility with Exif information, consult the manufacturer of the printer or the software.
- When you print images at a shop, images can be printed with the date if you ask them to do so.

Others

The lens gets fogged.

- Moisture condensation has occurred. Turn off the camera and leave it for about 1 hour before using it (page 214).

The message “Set Area/Date/Time.” appears when you turn on the camera.

- The camera has been left unused for sometime with a low battery or no battery pack. Charge the battery pack and set the date again (pages 33, 214). If the date setting is lost every time the battery pack is charged, consult your Sony dealer or local authorized Sony service facility.

The number of recordable images does not decrease or decreases 2 at a time.

- This is because the compression rate and the image size after compression change depending on the image when you shoot a JPEG image (page 172).

The setting is reset without the resetting operation.

- The battery pack was removed when the power switch was set to ON. When removing the battery pack, make sure the camera is turned off and the access lamp is not lit (pages 22, 27).

The camera does not work properly.

- Turn off the camera. Remove the battery pack and insert it again. If the camera is warm, remove the battery pack, and allow it to cool down before trying this corrective procedure.
- If an AC Adaptor (sold separately) is used, disconnect the power plug. Connect the power plug and turn on the camera again. If the camera does not work after doing these solutions, consult your Sony dealer or local authorized Sony service facility.

 is indicated on the screen.

- The SteadyShot function does not work. You can continue to shoot but the SteadyShot function will not work. Turn the camera off and on. If the SteadyShot scale continues to be indicated, consult your Sony dealer or local authorized Sony service facility.

“--E-” is indicated on the screen.

- Remove the memory card, and insert it again. If this procedure does not turn off the indication, format the memory card.

Warning messages

If the following messages appear, follow the instructions below.

Set Area/Date/Time.

- Set the area, date, and time. If you have not used the camera for a long time, charge the internal rechargeable battery (pages 33, 214).

Power insufficient.

- You tried to perform [Cleaning Mode] when the battery level is insufficient. Charge the battery pack or use the AC Adaptor (sold separately).

Unable to use memory card. Format?

- The memory card was formatted on a computer and the file format was modified. Select [Enter], then format the memory card. You can use the memory card again, however, all previous data in the memory card is erased. It may take a some time to complete the format. If the message still appears, change the memory card.

Memory Card Error

- An incompatible memory card is inserted or the format has failed.

Reinsert memory card.

- The inserted memory card cannot be used in your camera.
- The memory card is damaged.
- The terminal section of the memory card is dirty.

Memory card locked.

- You are using a memory card with a write-protect switch, and the switch is set to the LOCK position. Set the switch to the recording position.

Processing...

- When Long exposure noise reduction or High ISO noise reduction will be done for the same amount of time that the shutter was open. You cannot do any further shooting during this reduction.

Unable to display.

- Images recorded with other cameras or images modified with a computer may not be able to be displayed.

Check the lens attachment. If the lens is not supported, you can permit use of the lens in the custom menu.

- The lens is not attached properly, or the lens is not attached.
- When attaching the camera to an astronomical telescope or something similar, set [Release w/o Lens] to [Enable].

Unable to print.

- You tried to mark RAW images with a DPOF mark.

Camera overheating. Allow it to cool.

- The camera has become hot because you have been shooting continuously.
Turn the power off. Cool the camera and wait until the camera is ready to shoot again.



- Because you have been recording for a long time, the temperature inside the camera has increased to an unacceptable level. Stop recording.

Recording is unavailable in this movie format.

- Set [File Format] to [MP4].



- The number of images exceeds that for which date management in a database file by the camera is possible.



- Unable to register to the database file. Import all the images to a computer using “PMB” and recover the memory card.

**Camera Error
System Error**

- Turn the power off, remove the battery pack, then re-insert it. If the message appears frequently, consult your Sony dealer or local authorized Sony service facility.

Image Database File error. Recover?

- You cannot record or play back AVCHD View movies because the Image Database File is damaged. Follow the on-screen instructions to recover data.

**Unable to magnify.
Unable to rotate image.**

- Images recorded with other cameras may not be magnified or rotated.

Cannot create more folders.

- The folder with a name beginning with “999” exists on the memory card. You cannot create any folders if this is the case.

Precautions

Do not use/store the camera in the following places

- In an extremely hot, dry or humid place
In places such as in a car parked in the sun, the camera body may become deformed and this may cause a malfunction.
- Storing under direct sunlight or near a heater
The camera body may become discolored or deformed, and this may cause a malfunction.
- In a location subject to rocking vibration
- Near strong magnetic place
- In sandy or dusty places
Be careful not to let sand or dust get into the camera. This may cause the camera to malfunction, and in some cases this malfunction cannot be repaired.
- Humid places
These may mold on a lens.

On storing

Be sure to attach the front lens cap or body cap when not using the camera. When attaching the body cap, remove all the dust from the cap before placing it on the camera.

On operating temperatures

Your camera is designed for use under the temperatures between 0°C and 40°C (32°F and 104°F). Shooting

in extremely cold or hot places that exceed this range is not recommended.

On moisture condensation

If the camera is brought directly from a cold to a warm location, moisture may condense inside or outside the camera. This moisture condensation may cause a malfunction of the camera.

How to prevent moisture condensation

When bringing the camera from a cold place to a warm place, seal the camera in a plastic bag and allow it to adapt to conditions at the new location over about 1 hour.

If moisture condensation occurs

Turn off the camera and wait about an hour for the moisture to evaporate. Note that if you attempt to shoot with moisture remaining inside the lens, you will be unable to record clear images.

On the internal rechargeable battery

This camera has an internal rechargeable battery for maintaining the date and time and other settings regardless of whether the power is on or off, or the battery pack is charged or discharged.

This rechargeable battery is continually charged as long as you are using the camera. However, if you use the camera for only short periods, it discharges gradually, and if you do

not use the camera at all for about 3 months it becomes completely discharged. In this case, be sure to charge this rechargeable battery before using the camera.

However, even if this rechargeable battery is not charged, you can still use the camera as long as you do not record the date and time. If the camera resets the settings to the defaults each time you charge the battery, the internal rechargeable battery may be dead. Consult your Sony dealer or local authorized Sony service facility.

Charging method of the internal rechargeable battery

Insert a charged battery pack in the camera, or connect the camera to a wall outlet (wall socket) using the AC Adaptor (sold separately), and leave the camera for 24 hours or more with the power off.

On using the lenses and accessories

It is recommended that you use Sony lenses/accessories* designed to suit the characteristics of this camera.

Using the products of other manufacturers may cause the camera not to operate to its capability, or result in accidents and malfunctions of the camera.

* Konica Minolta products are included.

On memory cards

Do not attach a label, etc. on a memory card or a card adaptor. This may cause a malfunction.

On recording/playback

- When you use a memory card with this camera for the first time, it is recommended to format the card using the camera for stable performance of the memory card before shooting. Note that formatting permanently erases all data on the memory card, and is unrecoverable. Save precious data on a computer, etc.
- If you repeatedly record/delete images, fragmentation of data may occur on the memory card. Movies may not be able to be saved or recorded. In such a case, save your images to a computer or other storage location, then format the memory card (page 181).
- Before you record one-time events, make a trial recording to make sure that the camera is working correctly.
- This camera is designed to be dust- and moisture-resistant but not to be waterproof and splash-proof. When using the camera in the rain, be careful not to get the camera and lens wet. Clean the camera after use if the camera becomes dirty. With water, sand, dust, salt, etc., left on the camera, the camera may cause a malfunction.
- Do not look at the sun or a strong light through a removed lens or the

viewfinder. This may cause irrecoverable damage to your eyes. Or it may cause a malfunction of your camera.

- Do not use the camera near a location that generates strong radio waves or emits radiation. The camera may not be able to record or play back properly.
- Using the camera in sandy or dusty locations may cause malfunctions.
- If moisture condensation occurs, remove it before using the camera (page 214).
- Do not shake or strike the camera. In addition to malfunctions and an inability to record images, this may render the memory card unusable, or cause image data breakdown, damage or loss.
- Clean the flash surface with a soft cloth or something similar before use. The heat of flash emission may cause dirt on the flash surface to emit smoke or to become burned.
- Keep the camera, supplied accessories, etc., out of the reach of children. A memory card, etc., may be swallowed. If such a problem occurs, consult a doctor immediately.

To use your camera abroad — Power sources

You can use your camera and the battery charger and the AC-PW10AM AC Adaptor (sold separately) in any country or region where the power supply is within 100 V to 240 V AC, 50/60 Hz.

Note

- Do not use an electronic transformer (travel converter), as this may cause a malfunction.

On TV color systems

When you view images on a TV screen, the camera and TV must use the same TV color system.

NTSC system (1080 60i)

Bahama Islands, Bolivia, Canada, Central America, Chile, Colombia, Ecuador, Jamaica, Japan, Korea, Mexico, Peru, Surinam, Taiwan, the Philippines, the U.S.A., Venezuela, etc.

PAL system (1080 50i)

Australia, Austria, Belgium, China, Croatia, Czech Republic, Denmark, Finland, Germany, Holland, Hong Kong, Hungary, Indonesia, Italy, Kuwait, Malaysia, New Zealand, Norway, Poland, Portugal, Rumania, Singapore, Slovak Republic, Spain, Sweden, Switzerland, Thailand,

Turkey, United Kingdom, Viet Nam, etc.

PAL-M system (1080 50i)

Brazil

PAL-N system (1080 50i)

Argentina, Paraguay, Uruguay

SECAM system (1080 50i)

Bulgaria, France, Greece, Guiana, Iran, Iraq, Monaco, Russia, Ukraine, etc.

AVCHD format

The AVCHD format is a high definition digital video camera format used to record a high definition (HD) signal of either the 1080i specification*¹ or the 720p specification*² using efficient data compression coding technology. The MPEG-4 AVC/H.264 format is adopted to compress video data, and the Dolby Digital or Linear PCM system is used to compress audio data.

The MPEG-4 AVC/H.264 format is capable of compressing images at higher efficiency than that of the conventional image compressing format. The MPEG-4 AVC/H.264 format enables a high definition video signal shot on a digital video camera recorder to be recorded on 8 cm DVD discs, hard disk drive, flash memory, memory card, etc.

Recording and playback on your camera

Based on the AVCHD format, your camera records with the high definition image quality (HD) mentioned below.

Video signal*³:

1080 60i-compatible device

MPEG-4 AVC/H.264 1920 × 1080/60i, 1920 × 1080/60p, 1920 × 1080/24p

1080 50i-compatible device

MPEG-4 AVC/H.264 1920 ×

1080/50i, 1920 × 1080/50p, 1920 × 1080/25p

Audio signal: Dolby Digital 2ch
Recording media: Memory card

*1 1080i specification

A high definition specification which utilizes 1,080 effective scanning lines and the interlace system.

*2 720p specification

A high definition specification which utilizes 720 effective scanning lines and the progressive system.

*3 Data recorded in AVCHD format other than the above mentioned cannot be played on your camera.

GPS (SLT-A77V only)

This system allows you to pinpoint your exact location on the earth. The GPS satellites are located in 6 orbits, 20,000 km above the earth. The GPS system consists of 24 or more GPS satellites. A GPS receiver receives radio signals from the satellites, and calculates the current location of the receiver based on the orbital information (almanac data) and travel time of the signals, etc.

Determining a location is called “triangulating.” A GPS receiver can determine the location’s latitude and longitude by receiving signals from 3 or more satellites.

- As the positions of GPS satellites vary constantly, it may take longer to determine the location or the receiver may not be able to determine the location at all, depending on the location and time you use the camera.
- “GPS” is a system for determining geographic location by triangulating radio signals from GPS satellites. Avoid using the camera in places where radio signals are blocked or reflected, such as a shadowy place surrounded by buildings or trees, etc. Use the camera in open sky environments.
- You may not be able to record location information at locations or in situations where radio signals

from the GPS satellites do not reach the camera as follows.

- In tunnels, indoors or under the shade of buildings.
- Between tall buildings or at narrow streets surrounded by buildings.
- In underground locations, locations surrounded by dense trees, under an elevated bridge, or in locations where magnetic fields are generated, such as near high voltage cables.
- Near devices that generate radio signals of the same frequency band as the camera: near 1.5 GHz band mobile telephones, etc.

On triangulating errors

- If you move to another location right after turning on the camera, it may take a longer time for the camera to start triangulating, compared to when you stay in the same place.
- Error caused by the position of GPS satellites

The camera automatically triangulates your current location when the camera receives radio signals from 3 or more GPS satellites. The triangulating error allowed by the GPS satellites is about 30 m (98 feet). Depending on the environment of the location, the triangulating error can be greater. In this case, your actual location may not match the location on the map based on the GPS information. Meanwhile, the GPS satellites are controlled by the United States

Department of Defense, and the degree of accuracy may be changed intentionally.

- Error during the triangulating process
The camera acquires location information every about 15 seconds during triangulating. There is a slight time difference between when the location information is acquired and when the location information is recorded on an image, therefore, the actual recording location may not match exactly the location on the map based on the GPS information.

On the restriction of use of GPS on an airplane

During take off and landing of an airplane, turn off the camera, as you will be instructed to do by the on-board announcement.

On the other restriction

Use GPS in accordance with the regulations of the place or situation.

On the geographic coordinate system

The “WGS-84” geographic coordinate system is used.

3D-shootings

Notes on recording

- [3D Sweep Panorama] is not suitable when shooting:
 - Subjects are moving.
 - Subjects are too close to the camera.
 - Subjects with a repeating pattern such as tiles, and subjects with little contrast such as sky, sandy beach, or lawn.
- [3D Sweep Panorama] recording may be discontinued in the following situations:
 - You pan or tilt the camera too fast or too slow.
 - There is too much camera shake.
- If you cannot pan or tilt the camera across the entire subject within the given time, a black area occurs in the composed image. If this happens, move the camera fast to record a full panoramic image.
- Since several images are stitched together, the stitched part will not be recorded smoothly.
- Under low light conditions, images may be blurred.
- Under lights that flicker such as fluorescent light, images may not be recorded properly.
- When the whole angle of 3D panoramic shooting and the angle in which you fixed the focus and exposure with AE/AF lock are extremely different in brightness, color and focus, the shooting will not be successful. If this happens,

change the lock angle and shoot again.

- The available shooting direction is horizontal only.
- For details on the procedure used for shooting 3D-images, see page 45.

Note on playback of 3D-images

When you play back 3D-images on the LCD monitor of the camera or on a non-3D-compatible TV, the images are played back without the 3D effect.

Notes on 3D-image files

- A JPEG file and an MPO are combined to create a 3D-image. If you erase one of these files from the computer, the 3D-image may not be played back properly.
- For details on the procedure used for viewing 3D-images, see pages 162 and 167.

Memory card

Notes on using memory cards

- Do not strike, bend or drop the memory card.
- Do not use or store the memory card under the following conditions:
 - High temperature locations such as the hot interior of a car parked in direct sunlight.
 - Locations exposed to direct sunlight.
 - Humid locations or locations with corrosive substances present.
- The memory card may be hot just after it has been used for a long time. Be careful when you handle it.
- When the access lamp is lit, do not remove the memory card or the battery pack, or turn off the power. The data may be corrupted.
- Data may be damaged if you place the memory card near strongly-magnetized material or use the memory card in a static-prone or electrically noisy environment.
- We recommend backing up important data, such as to a hard disk of a computer.
- When you carry or store the memory card, put it in the case supplied with it.
- Do not expose the memory card to water.

- Do not touch the terminal section of the memory card with your hand or a metal object.
- When the write-protect switch of a memory card is set to the LOCK position, you cannot perform operations, such as recording or deleting images.
- The memory cards formatted with a computer are not guaranteed to operate with this camera. Be sure to format the memory cards using the camera.
- Data read/write speeds differ depending on the combination of the memory cards and the equipment used.
- Do not press down hard when you write down on the memo area.
- Do not attach a label on the memory cards themselves.
- Do not disassemble or modify the memory cards.
- Do not leave the memory cards within the reach of small children. They might accidentally swallow it.

Notes on the “Memory Stick” media used with the camera

The types of “Memory Stick” media that can be used with this camera are as follows. However, proper operation cannot be guaranteed for all “Memory Stick PRO Duo” media functions.

“Memory Stick PRO Duo”**media***1*2*3**“Memory Stick PRO-HG Duo”**
media*1*2

Available with your camera

**“Memory Stick Duo” media**

Unavailable with your camera

**“Memory Stick” media and “Memory Stick PRO” media**

Unavailable with your camera



- *1 This is equipped with MagicGate function. MagicGate is copyright protection technology that uses encryption technology. Data recording/playback that requires MagicGate functions cannot be performed with this camera.
- *2 Supports high-speed data transfer using a parallel interface.
- *3 When using “Memory Stick PRO Duo” media to record movies, only those marked with Mark2 can be used.

Notes on using “Memory Stick Micro” media (sold separately)

- This product is compatible with “Memory Stick Micro” media (“M2”). “M2” is an abbreviation for “Memory Stick Micro” media.
- To use a “Memory Stick Micro” media with the camera, be sure to insert the “Memory Stick Micro” media into an “M2” Adaptor as large as of Duo size. If you insert a “Memory Stick Micro” media into the camera without an “M2” Adaptor as large as of Duo size, you might not be able to remove it from the camera.
- Do not leave the “Memory Stick Micro” media within the reach of small children. They might accidentally swallow it.

Battery pack/ Battery charger

- The charging time differs depending on the remaining capacity of the battery pack or charging conditions.
- We recommend charging the battery pack in an ambient temperature of between 10 to 30°C (50 to 86°F). You may not be able to efficiently charge the battery pack outside of this temperature range.
- Connect the battery charger to the nearest wall outlet (wall socket).
- Do not try to charge the battery pack again right after it has been charged, or when it has not been used after being charged. Doing so will affect the performance of the battery pack.
- Do not charge any battery pack other than the “InfoLITHIUM” M series battery pack in the battery charger (supplied) with your camera. Batteries other than the specified kind may leak, overheat, or explode if you attempt to charge them, posing a risk of injury from electrocution and burns.
- When the CHARGE lamp flashes, this may indicate a battery error or that a battery pack other than the specified type has been installed. Check that the battery pack is the specified type. If the battery pack is the specified type, remove the battery pack, replace it with a new

one or another one and check if the battery charger operates correctly. If the battery charger operates correctly, a battery error may have occurred.

- If the battery charger is dirty, charging may not be performed successfully. Clean the battery charger with dry cloth, etc.

Notes on using the battery pack

- Use only an NP-FM500H battery pack. Note that the NP-FM55H, NP-FM50 and NP-FM30 cannot be used.
- The displayed level may not be correct under certain circumstances.
- Do not expose the battery pack to water. The battery pack is not water-resistant.
- Do not leave the battery pack in extremely hot places, such as in a car or under direct sunlight.

Effective use of the battery pack

- Battery performance decreases in low temperature surroundings. So, the time that the battery pack can be used is shorter in cold places and the speed of continuous shooting slows down. We recommend that you put the battery pack in a pocket close to your body to warm it up, and insert it in your camera immediately before you start shooting.
- The battery pack will run out quickly if you use the flash

frequently, use continuous shooting often, turn the camera on and off frequently, or set the LCD monitor brighter.

Battery life

- The battery life is limited. Battery capacity decreases little by little as you use it more and more, and as time passes. If the battery operating time seems shortened considerably, a probable cause is that the battery pack has reached the end of its life. Buy a new battery pack.
- The battery life varies according to how it is stored and the operating conditions and environment in which each battery pack is used.

How to store the battery pack

If the battery pack is not to be used for a long time, charge it and then fully use it up once a year on your camera before storing the battery pack in a dry, cool place to prolong the battery life.

The License

Notes on the License

“C Library”, “zlib”, and “libjpeg” software are provided in the camera. We provide this software based on license agreements with their owners of copyright. Based on requests by the owners of copyright of these software applications, we have an obligation to inform you of the following. Please read the following sections.

Read “license3.pdf” in the “License” folder on the CD-ROM. You will find licenses (in English) of “C Library”, “zlib”, and “libjpeg” software.

THIS PRODUCT IS LICENSED UNDER THE AVC PATENT PORTFOLIO LICENSE FOR THE PERSONAL AND NON-COMMERCIAL USE OF A CONSUMER TO

- (i) ENCODE VIDEO IN COMPLIANCE WITH THE AVC STANDARD (“AVC VIDEO”) AND/OR
- (ii) DECODE AVC VIDEO THAT WAS ENCODED BY A CONSUMER ENGAGED IN A PERSONAL AND NON-COMMERCIAL ACTIVITY AND/OR WAS OBTAINED FROM A VIDEO PROVIDER LICENSED TO PROVIDE AVC VIDEO.

NO LICENSE IS GRANTED OR SHALL BE IMPLIED FOR ANY OTHER USE.

ADDITIONAL INFORMATION MAY BE OBTAINED FROM MPEG LA, L.L.C.

SEE

[HTTP://WWW.MPEGLA.COM](http://www.mpegla.com)

On GNU GPL/LGPL applied software

The software that is eligible for the following GNU General Public License (hereinafter referred to as “GPL”) or GNU Lesser General Public License (hereinafter referred to as “LGPL”) are included in the camera.

This informs you that you have a right to have access to, modify, and redistribute source code for these software programs under the conditions of the supplied GPL/LGPL.

Source code is provided on the web. Use the following URL to download it.

<http://www.sony.net/Products/Linux/>
We would prefer you do not contact us about the contents of source code.

Read “license2.pdf” in the “License” folder on the CD-ROM. You will find licenses (in English) of “GPL”, and “LGPL” software.

To view the PDF, Adobe Reader is needed. If it is not installed on your computer, you can download it from the Adobe Systems web page:
<http://www.adobe.com/>

Checking the number of recordable images/recording time

Once you insert a memory card into the camera and set the power switch to ON, the number of images that can be recorded (should you continue to shoot using the current settings) is displayed on the screen.

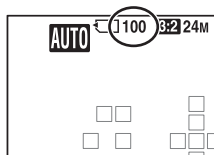

Notes

- When “0” (the number of recordable images) flashes in yellow, the memory card is full. Replace the memory card with another one, or delete images in the current memory card (pages 40, 165).
- When “NO CARD” (the number of recordable images) flashes in yellow, it means no memory card has been inserted. Insert a memory card.

The number of images that can be recorded on a memory card

The table shows the approximate number of images that can be recorded on a memory card formatted with this camera. The values are defined using Sony standard memory cards for testing. The values may vary depending on the shooting conditions and the type of memory card used.

Image Size: L 24M

Aspect Ratio: 3:2*

“Memory Stick PRO Duo”

(Units: Images)

Capacity \ Size	2GB	4GB	8GB	16GB	32GB
Standard	335	680	1350	2750	5500
Fine	205	410	830	1650	3300
RAW & JPEG	54	105	220	440	880
RAW	74	145	300	600	1200

* When [Aspect Ratio] is set to [16:9], you can record more images than the numbers shown in the table above (except when [RAW] is selected).

The number of images that can be recorded using a battery pack

The approximate number of images that can be recorded is as follows when you use the camera with the battery pack (supplied) at full capacity. Note that the actual numbers may be less than those indicated depending on the conditions of use.

	SLT-A77	SLT-A77V
LCD monitor mode	Approx. 530 images	Approx. 530 images
Viewfinder mode	Approx. 470 images	Approx. 470 images

- The number is calculated with a battery pack at full capacity and in the following situation:
 - At an ambient temperature of 25°C (77°F).
 - Using the battery pack that is charged for an hour after the CHARGE lamp goes out.
 - Using Sony “Memory Stick PRO Duo” media (sold separately).
 - [Quality] is set to [Fine].
 - [Autofocus Mode] is set to [Automatic AF].
 - Shooting once every 30 seconds.
 - The flash strobes once every 2 times.
 - The power turns on and off once every 10 times.
 - [GPS On/Off] is set to [On] (SLT-A77V only).
- The measurement method is based on the CIPA standard.
(CIPA: Camera & Imaging Products Association)

Available recording time for a movie

The table below shows the approximate total recording times using a memory card formatted with this camera.

"Memory Stick PRO Duo"

(h (hour), m (minute))

Capacity Record Setting	2GB	4GB	8GB	16GB	32GB
60i 24M(FX)/50i 24M(FX)	10 m	20 m	40 m	1 h 30 m	3 h
60i 17M(FH)/50i 17M(FH)	10 m	30 m	1 h	2 h	4 h 5 m
60p 28M(PS)/50p 28M(PS)	9 m	15 m	35 m	1 h 15 m	2 h 30 m
24p 24M(FX)/25p 24M(FX)	10 m	20 m	40 m	1 h 30 m	3 h
24p 17M(FH)/25p 17M(FH)	10 m	30 m	1 h	2 h	4 h 5 m
1440×1080 12M	20 m	40 m	1 h 20 m	2 h 45 m	5 h 30 m
VGA 3M	1 h 10 m	2 h 25 m	4 h 55 m	10 h	20 h 5 m

Notes

- The recordable time of movies varies for the reason that the camera equipped with VBR (Variable Bit Rate) which automatically adjusts image quality depending on shooting scene. When you record fast-moving subject, the image is clearer but the recordable time is shorter because it spends much memory to record. The recordable time also vary depending on the shooting condition or subject or setting of image quality/size.
- The values shown are not the continuous recording time.
- Recording time may depend on shooting conditions and the memory card used.
- When [L] is indicated, stop recording the movie. The temperature inside the camera has increased to an unacceptable level.
- For details on movie playback, see page 39.

Notes on continuous movie recording

- It requires a lot of power to perform high quality movie recording or continuous shooting using the APS-C size image sensor. Therefore, if you continue to shoot, the temperature inside the camera will rise, especially that of the image sensor. In such cases, the camera is turned off automatically since higher temperatures affect the quality of the images or burden the internal mechanism of the camera.
- The duration of time available for movie recording is as follows when the camera starts recording after the power of the camera has been turned off for a while. (The

following values indicate the continuous time from when the camera starts recording until the camera stops recording.)

Ambient temperature	Continuous recording time for movies
20°C (68°F)	About 29 minutes
30°C (86°F)	About 29 minutes
40°C (104°F)	About 13 minutes

- The duration of time available for movie recording varies with the temperature or condition of the camera before you start recording. If you frequently recompose or shoot images after the power is turned on, the temperature inside the camera rises and the recording time available is shorter than the values indicated in the table above.
- If the camera stops recording due to the temperature, leave it for several minutes with the power turned off. Start recording after the temperature inside the camera drops fully.
- If you observe the following points, the recording time is longer.
 - Keep the camera out of direct sunlight.
 - Turn the camera off when it is not being used.
 - If possible, use a tripod and disable the SteadyShot function.
- The maximum size of a movie file is about 2 GB. When the file size is about 2 GB, the recording stops automatically when [File Format] is set to [MP4], and a new movie file is created automatically when [File Format] is set to [AVCHD 60i/60p]/[AVCHD 50i/50p].
- The maximum continuous recording time is 29 minutes.

Specifications

Camera

[System]

Camera Type	Interchangeable Lens Digital Camera
Lens	A-mount lens

[Image sensor]

Image format	23.5 mm×15.6 mm (APS-C format) CMOS image sensor
Total pixel number of image sensor	Approx. 24 700 000 pixels
Effective pixel number of camera	Approx. 24 300 000 pixels

[SteadyShot]

For still images	System: Image sensor-shift mechanism Effect: Approx. 2.5 EV to 4.5 EV in shutter speed (depending on shooting conditions and the attached lens)
For movies	System: Electronic

[Anti-Dust]

System	Charge protection coating on Low-Pass Filter and image sensor-shift mechanism
--------	---

[Auto focus system]

System	TTL phase-detection system, 19 points (11 points cross type)
Sensitivity Range	-1 EV to 18 EV (at ISO 100 equivalent)
AF illuminator	Approx. 1 m to 7 m (3.3 feet to 23 feet)

[Electronic viewfinder]

Type	Electronic viewfinder (Organic Electro-Luminescence)
Screen size	1.3 cm (0.5 type)
Total number of dots	2 359 296 dots
Frame coverage	100%
Magnification	1.09 × with 50 mm lens at infinity, -1 m ⁻¹ (diopter)

Eye Point	Approximately 27 mm from the eyepiece, 22 mm from the eyepiece frame at -1 m^{-1}
Diopter Adjustment	-4.0 m^{-1} to $+3.0 \text{ m}^{-1}$ (diopter)

[LCD monitor]

LCD panel	7.5 cm (3.0 type) TFT drive
Total number of dots	921 600 (640 × 3 (RGB) × 480) dots

[Exposure control]

Metering Cell	“Exmor” CMOS sensor
Metering method	1 200-zone evaluative metering
Metering Range	-2 EV to $+17 \text{ EV}$ on Multi segment, Center weighted, Spot modes (at ISO 100 equivalent with F1.4 lens)
ISO sensitivity (Recommended exposure index)	Still images: AUTO, ISO 50 to 16 000 (1 EV step) Movies: AUTO, ISO 100 to 1 600 (1 EV step)
Exposure compensation	$\pm 5.0 \text{ EV}$ (switchable between 1/3 and 1/2 EV steps)

[Shutter]

Type	Electronically-controlled, vertical-traverse, focal-plane type
Speed range	Still images: 1/8 000 second to 30 seconds, bulb Movies: 1/8 000 second to 1/4 second (1/3 step), up to 1/60 in AUTO mode
Flash sync speed	1/250 second

[Built-In-Flash]



Flash G.No.	GN 12 (in meters at ISO 100)
Recycling time	Approx. 3 seconds
Flash coverage	Covering 16 mm lens (focal length that the lens indicates)
Flash compensation	$\pm 3.0 \text{ EV}$ (switchable between 1/3 and 1/2 EV steps)

Flash range

Aperture		F2.8	F4.0	F5.6
ISO setting	100	1 m – 4.2 m (3.3 feet – 14 feet)	1 m – 3 m (3.3 feet – 9.8 feet)	1 m – 2.1 m (3.3 feet – 6.9 feet)
	200	1.4 m – 6 m (4.6 feet – 20 feet)	1.4 m – 4.2 m (4.6 feet – 14 feet)	1.4 m – 3 m (4.6 feet – 9.8 feet)
	400	2 m – 8.4 m (6.6 feet – 28 feet)	2 m – 6 m (6.6 feet – 20 feet)	2 m – 4.2 m (6.6 feet – 14 feet)
	800	2.8 m – 12 m (9.2 feet – 39 feet)	2.8 m – 8.4 m (9.2 feet – 28 feet)	2.8 m – 6 m (9.2 feet – 20 feet)

[Continuous shooting]

Continuous shooting speed

Continuous Advance Priority AE: Maximum 12 images per second/ Hi: Maximum 8 images per second/ Lo: Maximum 3 images per second

- Our measurement conditions. The speed of continuous shooting is slower, depending on shooting conditions.

The maximum number of continuous shots

In Continuous Advance Priority AE mode

Extra fine: 13 images/Fine: 17 images/Standard: 17 images/RAW & JPEG: 11 images/RAW: 13 images

In Continuous shooting

Extra fine: 13 images/Fine: 18 images/Standard: 18 images/RAW & JPEG: 11 images/RAW: 13 images

[Image zooming playback]

Scaling range

Image size: L: Approx. $\times 1.0$ – $\times 13.6$ /M: Approx. $\times 1.0$ – $\times 9.9$ /S: Approx. $\times 1.0$ – $\times 6.8$ **[Recording format]**

File format

JPEG (DCF Ver. 2.0, Exif Ver. 2.3, MPF Baseline) compliant, DPOF compatible

3D still images

MPO (MPF Extended (Disparity Image)) compliant

Movie (AVCHD format)

AVCHD Ver. 2.0 compliant

Video: MPEG-4 AVC/H.264

Audio: Dolby Digital 2ch, equipped with Dolby Digital Stereo Creator

	<ul style="list-style-type: none"> • Manufactured under license from Dolby Laboratories.
Movie (MP4 format)	Video: MPEG-4 AVC/H.264 Audio: MPEG-4 AAC-LC 2ch

[Recording media]

“Memory Stick PRO Duo” media, SD card

[Input/output terminals]

USB	miniB, Hi-Speed USB (USB 2.0)
HDMI	HDMI minijack
Mic Terminal	∅ 3.5 mm Stereo minijack
REMOTE Terminal	

[Power, general]

Used battery pack	Rechargeable battery pack NP-FM500H
-------------------	-------------------------------------

[Others]

Microphone	Stereo
Speaker	Monaural
Exif Print	Compatible
PRINT Image Matching III	Compatible
Dimensions	Approx. 142.6 mm × 104.0 mm × 80.9 mm (5 3/4 inches × 4 1/8 inches × 3 1/4 inches) (W/H/D, excluding protrusions)
Mass	Approx. 732 g (1 lb 9.8 oz) (with battery and “Memory Stick PRO Duo” media) Approx. 653 g (1 lb 7.0 oz) (body only)
Operating temperature	0°C to 40°C (32°F to 104°F)

On image data compatibility

- This camera conforms with DCF (Design rule for Camera File system) universal standard established by JEITA (Japan Electronics and Information Technology Industries Association).
- Playback of images recorded with your camera on other equipment and playback of images recorded or edited with other equipment on your camera are not guaranteed.

Design and specifications are subject to change without notice.

Battery charger/Battery

BC-VM10A Battery charger

Input rating	100 V - 240 V AC, 50/60 Hz, 9 W
Output rating	8.4 V DC, 0.75 A
Operating temperature range	0°C to 40°C (32°F to 104°F)
Storage temperature range	-20°C to +60°C (-4°F to +140°F)
Maximum dimensions	Approx. 70 mm × 25 mm × 95 mm (2 7/8 inches × 1 inch × 3 3/4 inches) (W/H/D)
Mass	Approx. 90 g (3.2 oz)

Rechargeable battery pack NP-FM500H

Used battery	Lithium-ion battery	
Maximum voltage	DC 8.4 V	
Nominal voltage	DC 7.2 V	
Maximum charge voltage	DC 8.4 V	
Maximum charge current	2.0 A	
Capacity	Typical	11.8 Wh (1 650 mAh)
	Minimum	11.5 Wh (1 600 mAh)
Maximum dimensions	Approx. 38.2 mm × 20.5 mm × 55.6 mm (1 9/16 inches × 13/16 inches × 2 1/4 inches) (W/H/D)	
Mass	Approx. 78 g (2.8 oz)	

Lens

Name (Model name)	DT 18-55mm F3.5-5.6 SAM (SAL1855)	DT 16-50mm F2.8 SSM (SAL1650)	DT 18-135mm F3.5-5.6 SAM (SAL18135)
Equivalent 35mm-format focal length* (mm)	27-82.5	24-75	27-202.5
Lens groups-elements	7-8	13-16	11-14
Angle of view*	76°-29°	83°-32°	76°-12°
Minimum focus** (m (feet))	0.25 (0.82)	0.3 (1)	0.45 (1.48)

Name (Model name)	DT 18-55mm F3.5-5.6 SAM (SAL1855)	DT 16-50mm F2.8 SSM (SAL1650)	DT 18-135mm F3.5-5.6 SAM (SAL18135)
Maximum magnification (X)	0.34	0.2	0.25
Minimum f-stop	f/22-36	f/22	f/22-36
Filter diameter (mm)	55	72	62
Dimensions (maximum diameter × height) (approx., mm (in.))	69.5×69 (2 3/4 × 2 3/4)	81×88 (3 1/4 × 3 1/2)	76×86 (3 × 3 1/2)
Mass (approx., g (oz.))	210 (7 4/8)	577 (20 3/8)	398 (14)

* The values for equivalent 35mm-format focal length and angle of view are based on Interchangeable Lens Digital Camera equipped with an APS-C sized image sensor.

** Minimum focus is the shortest distance from the image sensor to the subject.



- This lens is equipped with a distance encoder. The distance encoder allows more accurate measurement (ADI) by using a flash for ADI.
- Depending on the lens mechanism, the focal length may change with any change of the shooting distance. The focal length assumes the lens is focused at infinity.
- The infinity position provides for some adjustment to compensate for focus shift caused by change in temperature. To shoot a subject at infinite distance in MF mode, use the viewfinder and set focus.

On focal length

The picture angle of this camera is narrower than that of a 35 mm-format camera. You can find the approximate equivalent of the focal length of a 35 mm-format camera, and shoot with the same picture angle, by increasing the focal length of your lens by half.

For example, by using a 50 mm lens, you can get the approximate equivalent of a 75 mm lens of a 35 mm-format camera.

Trademarks

- **α** is a trademark of Sony Corporation.
- “Memory Stick,” , “Memory Stick PRO,” **MEMORY STICK PRO**, “Memory Stick Duo,” **MEMORY STICK DUO**, “Memory Stick PRO Duo,” **MEMORY STICK PRO DUO**, “Memory Stick PRO-HG Duo,” **MEMORY STICK PRO-HG DUO**, “Memory Stick Micro,” “MagicGate,” and **MAGICGATE** are trademarks of Sony Corporation.
- “InfoLITHIUM” is a trademark of Sony Corporation.
- “PhotoTV HD” is a trademark of Sony Corporation.
- “AVCHD Progressive” and “AVCHD Progressive” logotype are trademarks of Panasonic Corporation and Sony Corporation.
- Blu-ray Disc TM and Blu-ray TM are trademarks of the Blu-ray Disc Association.
- Dolby and the double-D symbol are trademarks of Dolby Laboratories.
- Microsoft, Windows, DirectX, and Windows Vista are either registered trademarks or trademarks of Microsoft Corporation in the United States and/or other countries.
- HDMI, the HDMI logo and High-Definition Multimedia Interface are trademarks or registered trademarks of HDMI Licensing LLC.
- Macintosh and Mac OS are trademarks or registered trademarks of Apple Inc.
- PowerPC is a registered trademark of IBM Corporation in the United States.
- Intel, Intel Core, MMX, and Pentium are trademarks or registered trademarks of Intel Corporation.
- SDXC Logo is a trademark of SD-3C, LLC.
- Eye-Fi is a trademark of Eye-Fi Inc.
- MultiMediaCard is a trademark of MultiMediaCard Association.
- “” and “PlayStation” are registered trademarks of Sony Computer Entertainment Inc.
- Adobe is a registered trademark or a trademark of Adobe Systems Incorporated in the United States and/or other countries.
- In addition, system and product names used in this manual are, in general, trademarks or registered trademarks of their respective developers or manufacturers. However, the TM or ® marks are not used in all cases in this manual.



- Add further enjoyment with your PlayStation 3 by downloading the application for PlayStation 3 from PlayStation Store (where available.)
- The application for PlayStation 3 requires PlayStation Network account and application download.

Accessible in areas where the PlayStation Store is available.



Index

Numerics

3D..... 45, 100, 221

A

Adobe RGB..... 175

AE Lock..... 131

AEL button 174

AF area..... 119

AF drive speed..... 66

AF illuminator..... 120

AF Micro Adj..... 121

AF w/ shutter 63

AF/MF button 177

AF/MF control 126

AF-A setup..... 125

Ambient light 157

Anti-dust function 200

Aperture 103

Aperture Priority 103

Area Setting 34

Aspect ratio 172

Audio signals 69

Auto HDR..... 142

Auto review..... 176

AUTO+ 43, 96

Auto+ Cont. Shooting 96

Auto+ Image Extract..... 96

Autoflash..... 47, 135

Autofocus..... 116

AVCHD 77, 114, 218

B

Battery pack 25, 27, 224

Bracket 155

Bracket order..... 66

“BRAVIA” Sync..... 167

BULB shooting 109

C

Center weighted 132

Charging battery pack 25

Cleaning mode 200

Color filter..... 150

Color Space 175

Color temperature 150

Compression ratio 172

Computer..... 71

Continuous Advance Priority AE
..... 46, 101

Continuous bracket 155

Continuous shooting 154

Contrast 145

Creative Style..... 145

Ctrl dial setup 66

CTRL FOR HDMI..... 167

Custom white balance 150

D

Date imprint 198

Date/Time setup 33

DC IN terminal..... 22

- Delete.....40, 165
- Delete confirm.....69
- Dial exp.comp.....50, 66
- Digital level gauge.....89
- Diopter-adjustment35
- Direct manual focus.....125
- Disc creation77, 195
- Display panel93
- DPOF Setup.....198
- D-Range Optimizer141
- Drive mode51, 154
- DRO Bracket158
- E**
- Enlarged image55
- EV scale.....108, 157
- Exp.comp.set66
- Exposure compensation.....49
- Eyecup86
- Eye-Fi183
- Eyepiece sensor20
- Eye-Start AF.....64
- F**
- Face Detection127
- Face Registration128
- File Number.....181
- Fill-flash47, 135
- Flash bracket.....155
- Flash compensation132
- Flash control133
- Flash mode.....47, 83, 135
- Flash Off47, 135
- Fn button.....58, 60
- Focal length236
- Focus.....116
- Focus Hold Button.....66
- Focus indicator.....118
- Focus Magnifier.....124
- Focus-lock.....119
- Folder Name181
- Format.....181
- Front control dial55
- Func. of AEL button176
- G**
- GPS169, 219
- GPS assist data.....170
- GPS Auto Time Cor.....170
- Grid Line.....176
- H**
- Hand-held Twilight.....44, 97
- HDMI Resolution167
- High ISO NR174
- High-speed sync.....135
- Histogram88
- I**
- Image Data Converter.....74
- Image Index56
- Image quality172
- Image size53
- ISO sensitivity139

- J**
- JPEG 172
- L**
- Landscape 44, 97
 - Language 69
 - LCD brightness 178
 - LCD monitor 79, 90, 159
 - Lens 30
 - Lens Comp.: Chromatic Aberration 180
 - Lens Comp.: Distortion 180
 - Lens Comp.: Peripheral Shading 180
 - Live View Display 89
 - Long exp.NR 174
- M**
- Macro 44, 97
 - Manual Exposure 107
 - Manual focus 123
 - Memory 185
 - Memory card 27, 222
 - Memory recall 185
 - Menu 62
 - Metering mode 132
 - Moisture condensation 214
 - Movie Audio Recording 115
 - Movie File Format 113
 - Multi frame noise reduction 140
 - Multi segment 132
 - Multi-selector 58
- N**
- New Folder 182
 - Night Portrait 44, 97
 - Night Scene 44, 97
 - Number of recordable images 227, 228
- O**
- Object Tracking 121
- P**
- Picture Effect 144
 - PlaybackDisplay 162
 - PMB 75
 - PMB Launcher 74
 - Portrait 44, 97
 - Power ratio 134
 - Power Save 179
 - Preset white balance 149
 - Pressing halfway down 37
 - Preview 105
 - Preview Button 177
 - Print 198
 - Priority setup 63
 - Program Auto 102
 - Protect 164
- Q**
- Quality 172
- R**
- RAW 172

- Rear control dial55
- Rear sync.47, 135
- Record Setting114
- Recording movies38, 111
- Recover Image DB183
- Red Eye Reduction64
- Reducing camera shake94
- Release w/o Lens175
- Remote Commander22, 158
- Reset186
- Rotate.....161
- S**
- Saturation.....145
- Scene Selection.....44, 97
- Select REC Folder182
- Self-timer155
- Set the clock33
- Sharpness145
- Shooting.....36
- Shoulder strap22
- Shutter Priority105
- Shutter speed105
- Single Bracket155
- Slide show162
- Slow Sync136
- Smart teleconverter.....153
- Smile Shutter129
- Software.....73
- Specifications231
- Sports Action44, 97
- Spot.....132
- SteadyShot function..... 94
- Sunset..... 44, 97
- Sweep Panorama..... 45, 53, 99
- Sweep Shooting 45, 99
- U**
- USB connection 191
- V**
- Version..... 190
- View Mode 161
- Viewfinder 179
- Viewing image..... 39, 161
- Viewing images on a TV screen
..... 57, 167
- W**
- White balance 148
- White balance bracket..... 157
- Wind Noise Reduc. 115
- Wireless flash..... 135
- Wireless Remote Commander
..... 158