

CONTENTS



	Page
PARTS LIST & DRAWING	
GENERAL OUTLINE AND MECHANICAL FEATURES	1
CHECK POINTS (INSPECTION STANDARDS)	26
ORDER OF DISASSEMBLY	48
OUTLINE OF REPAIRS	61
PARTS WHERE OIL, GREASE, ETC. SHALL BE USED	128
SPECIAL TOOLS	148
OTHERS	150



C O R R I G E N D A

Page	Column, Box & Line	Incorrect	Correct
37	Right C. 7th L. from bottom	without no friction	without friction
59	in Fig.	2.5 teeth	1.5 or 2.5 teeth
61, 70	16	CA9072 titled	CA9072 tilted
74	Right C. 2nd B. 3rd L.	by a 6V tester with	by a 3V tester with
77	Center C. bottom L.	0.7mm or more	0.4mm or more
95	3rd L. from bottom bottom L.	instead of V in 6 Defective Normal	instead of ∇ in $\textcircled{6}$ Normal Defective
104	Center C. bottom L.	Approx. 8mV--12mV	Approx. 8mA--12mA
108	Right C 1st L. Right C. 9th L.	Disconnect the black (2 wires of . . .	Disconnect the blue (2 index lines of ..
109	Center C. in Fig.	R305 R304	R306 R305
120	Center C. Fig.	Cemedine 3000RS	Concave (die casting)
121	Left C. 3rd L. Center C. 1st L. Center C. Fig.	R306 R306 $\approx 2.4 \text{ K}\Omega$	R305 R305 $\approx 68.3 \text{ K}\Omega$
122	Left C. 2nd B. 6th L.	2.5 teeth	1.5 or 2.5 teeth
15 76, 92, 94, 98, 99, 102, 103, 104, etc.	3rd L. in Fig.	Off Set OFF set "	Offset " "



OUTLINE OF REPAIRS

Complimentary Copy
Not for Resale

PRECAUTIONS FOR REPAIRS

The Model OM-2 is designed for very weak electricity in its electronic parts of the automatic exposure device so that it can measure and control an extremely low level of luminance (-5.5EV at ASA 100).

The electronic parts thus tend to be affected by static electricity or a voltage larger than that of the batteries used, and to suffer easily performance degradation or breakage due to the static electricity that a human body usually possesses. (The OM-2, however, is designed so as not cause such disadvantage in a completed state.)

Because of the above reason, if you should handle the OM-2 in the same way as with other cameras in repairs, the electric parts may be broken causing serious trouble that requires replacement of the shutter amplifier (M circuit board).

Take particularly the following cautions in repairs.

1. For the troubleshooting of the shutter amplifier and related mechanism, be sure to ground all materials that come into contact with the electronic parts including the human body, repair tools and work bench, and commence repair work after making sure the condition free from static electricity is achieved. (The ICs of MOS FET and IR024 are particularly delicate.)
2. For the soldering work, use a three-wire type soldering iron with the tip grounded.

3. The electronic parts are weak against heat. Thus, the soldering work must be made securely in a short time, 3 seconds for one place as a rule.
4. The shutter amplifier (M circuit board) requires very high insulation resistance on its every part, and must be kept free from dust, smudges, etc.
5. For the soldering of the shutter amplifier (M circuit board), use solder containing silver. If ordinary solder should be used, the silver in the circuit pattern may be absorbed by the solder causing unstuck soldering.
6. When a constant-voltage power supply is used in the shutter amplifier (M circuit board) repair work, do not turn on and off the main switch of the power supply leaving it connected to the M circuit board. Back electromotive force may break the electronic parts.
7. When a continuity test is made in the shutter amplifier (M circuit board) repair work, avoid to use the 3V tester for the case other than specified in the OUTLINE OF REPAIRS. The electronic parts may be broken.
8. For other cautions, see each item in the OUTLINE OF REPAIRS.



PARTS LIST & DRAWING

Complimentary Copy
Not for Resale

EXPLANATORY NOTES ON VARIOUS MARKS &
NUMBERS USED IN IMPROVED PARTS TABLE &
PARTS LIST

- ★ Only Body Die-Cast is not available in case of overseas.
 - ① An assembled parts is supplied including parts marked with ①
 - ① Single parts is supplied.
 - () Not to be supplied in single parts, but as an assembled parts.
 - ↺ Left-handed screw. (the mate screw hole is not marked particularly).
All right-handed screws have no special indication.
 - < > Improved parts. Number shows INDEX in IMPROVED PARTS TABLE where more
details are explained.
 - == No more available parts.
 - ➡ The place where parts have been improved.
 - [] Dimensions of improved parts and improved points.
 - ♥♠♦♣ Replacing parts of no more available parts marked with ==.
 - ※ How to replace parts or how to repair.
 - Original parts are also usable instead of improved parts.
 - ✕ Printing error. No parts are built-in cameras.
- Clarify HOUSE CODE, PARTS NUMBER and QUANTITY in your ORDER SHEETS.

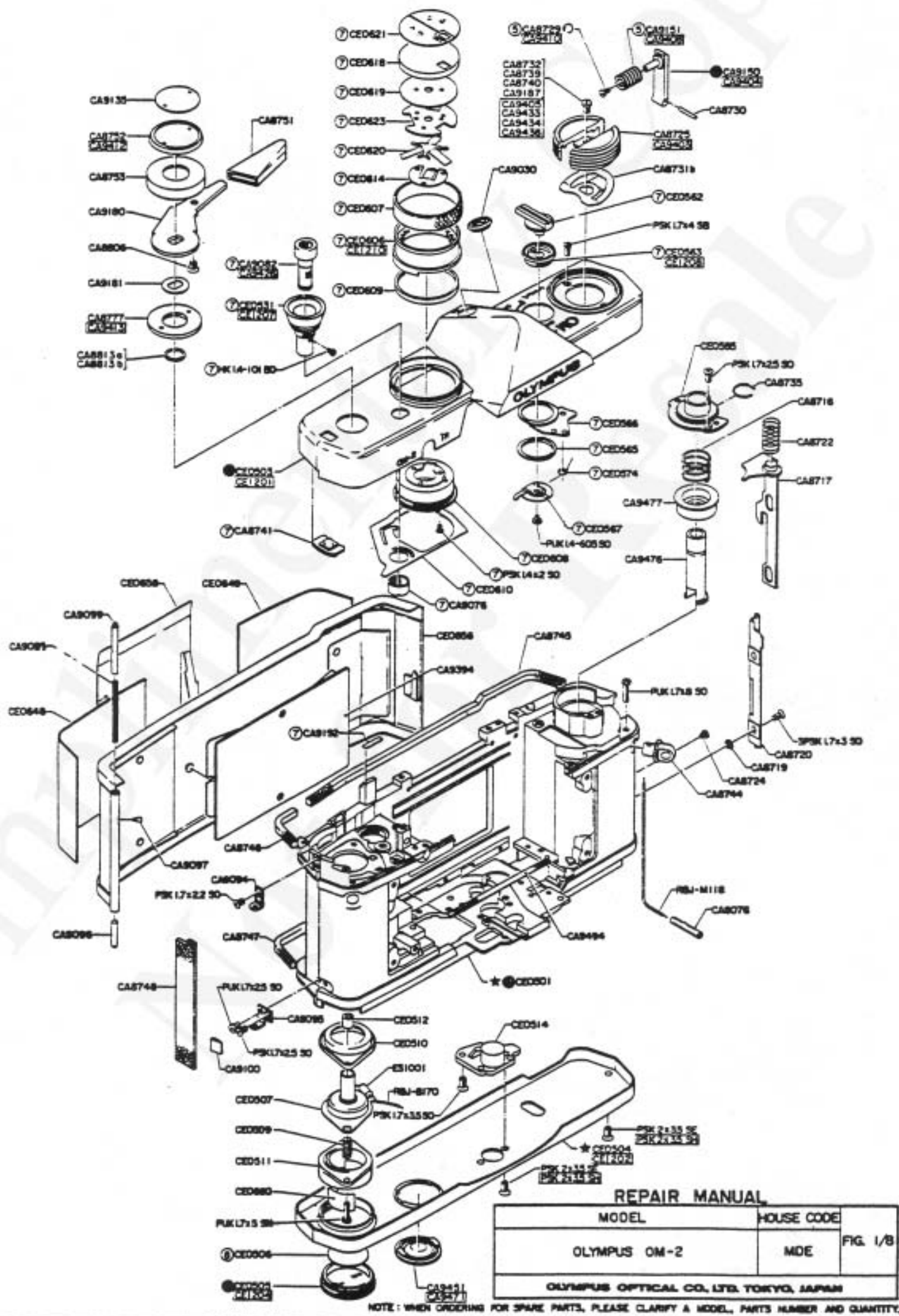

REPAIR MANUAL

MODEL	HOUSE CODE	
OLYMPUS OM-2	MDE	FIG. 1/8
OLYMPUS OPTICAL CO., LTD. TOKYO, JAPAN		

NOTE: WHEN ORDERING FOR SPARE PARTS, PLEASE CLARIFY A MODEL, PARTS NUMBER AND QUANTITY.

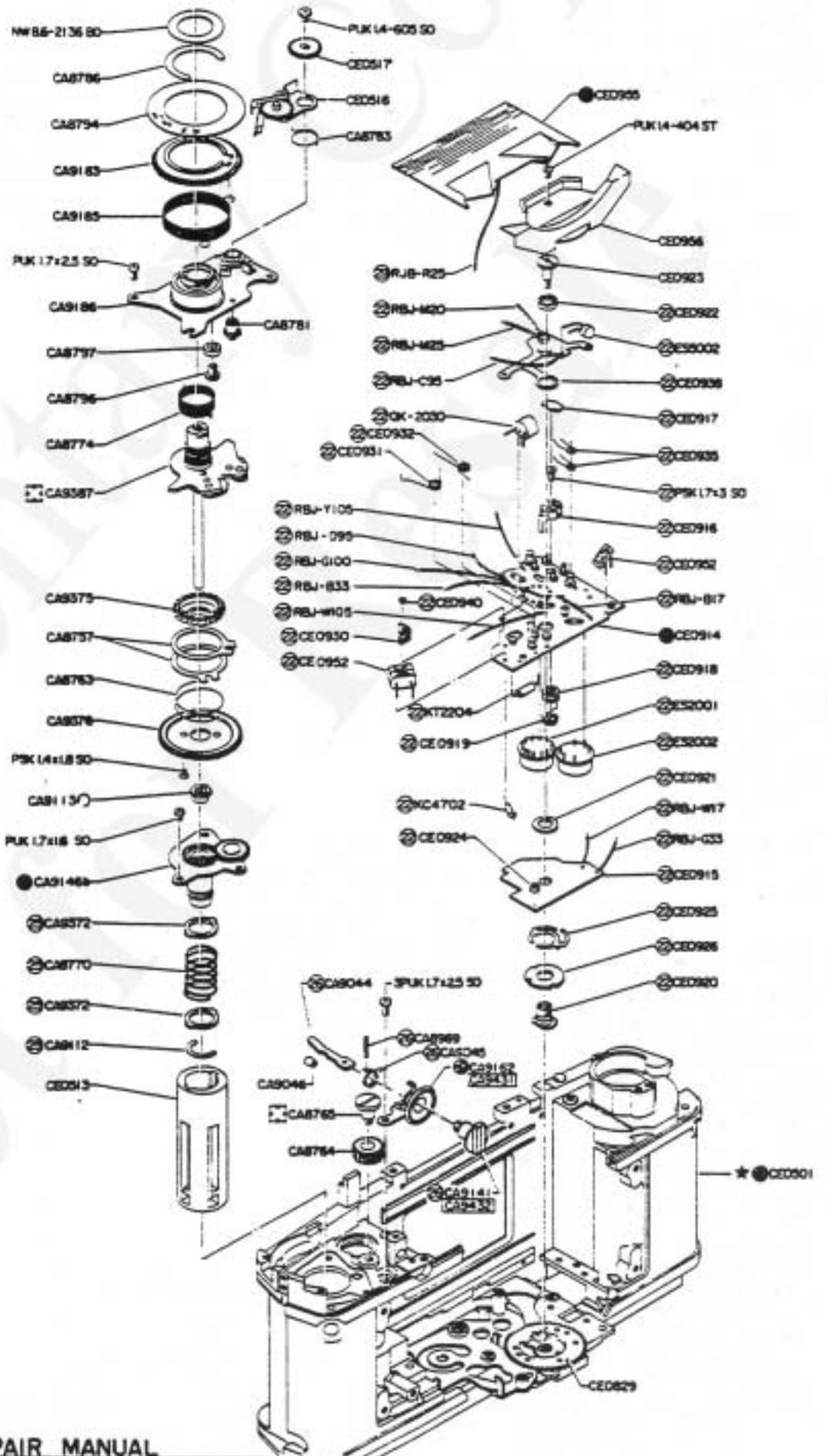

REPAIR MANUAL

MODEL	HOUSE CODE	FIG. 2/8
OLYMPUS OM-2	MDE	
OLYMPUS OPTICAL CO., LTD. TOKYO, JAPAN		

NOTE: WHEN ORDERING FOR SPARE PARTS, PLEASE CLARIFY A MODEL, PARTS NUMBER AND QUANTITY.

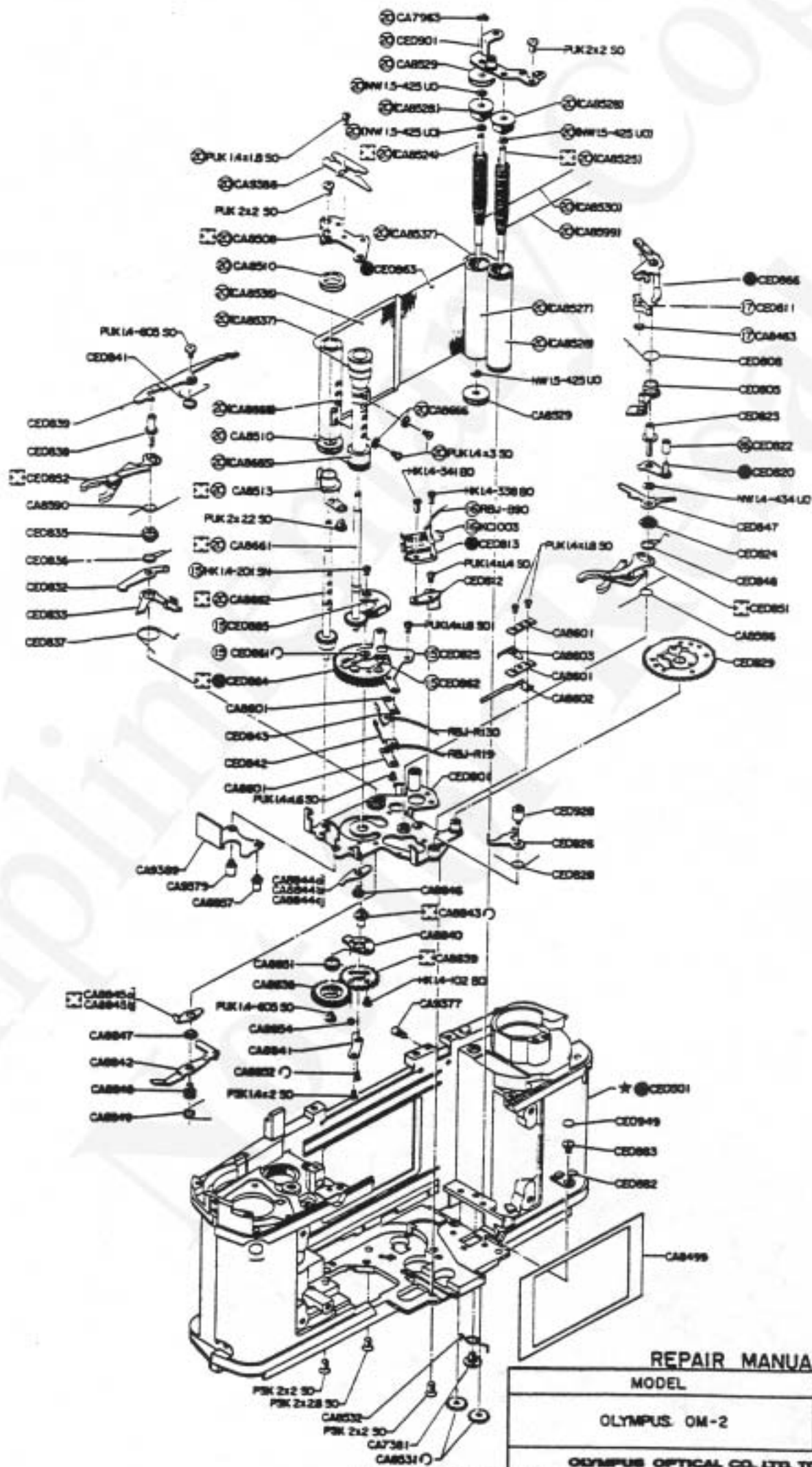

REPAIR MANUAL

MODEL	HOUSE CODE	
OLYMPUS OM-2	MDE	FIG. 3/8
OLYMPUS OPTICAL CO., LTD. TOKYO, JAPAN		

NOTE: WHEN ORDERING FOR SPARE PARTS, PLEASE CLARIFY A MODEL, PARTS NUMBER AND QUANTITY.

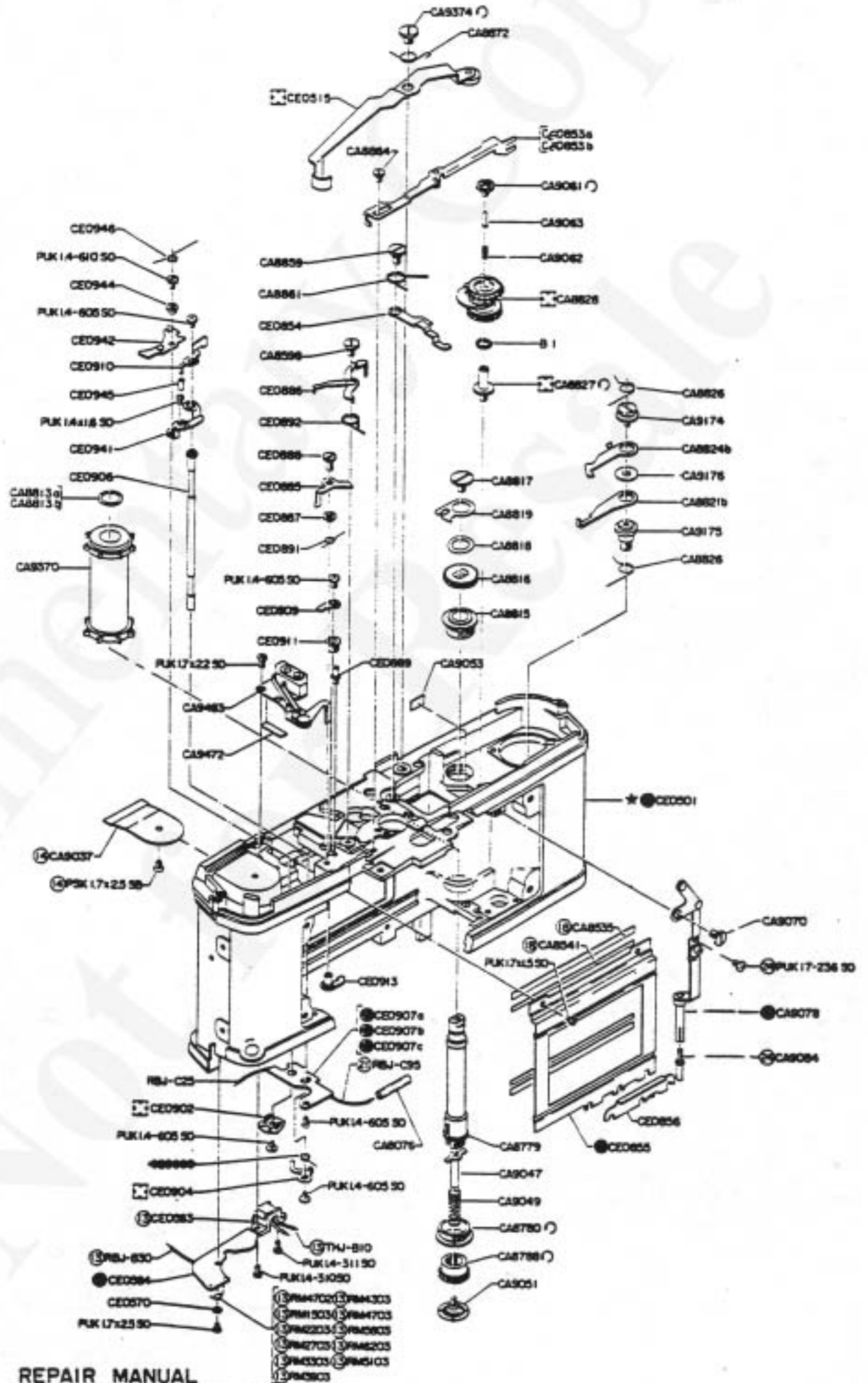

REPAIR MANUAL

MODEL	HOUSE CODE	FIG. 4/8
OLYMPUS OM-2	MOE	

OLYMPUS OPTICAL CO. LTD. TOKYO, JAPAN

NOTE: WHEN ORDERING FOR SPARE PARTS, PLEASE CLARIFY A MODEL, PARTS NUMBER AND QUANTITY.

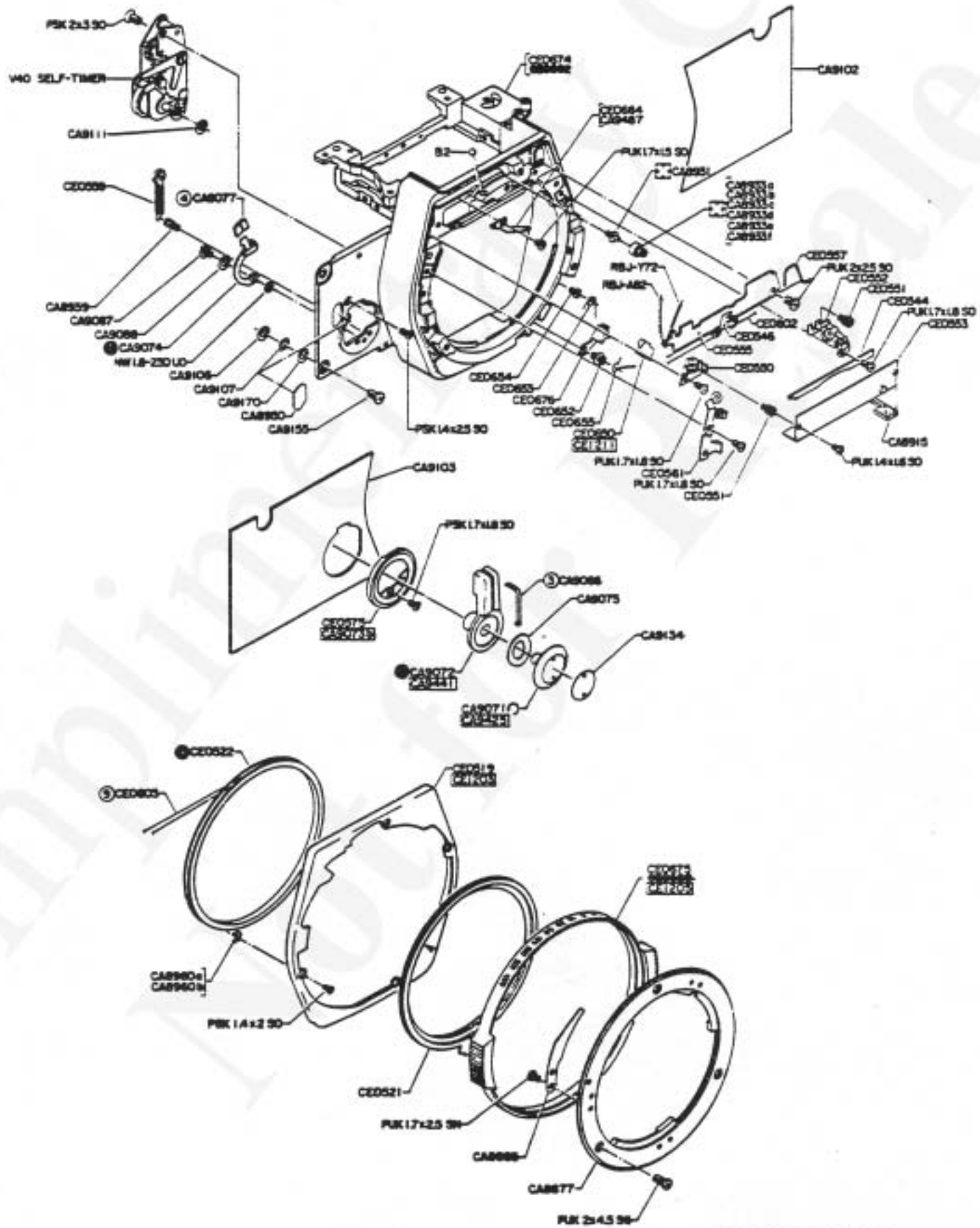

REPAIR MANUAL

MODEL	HOUSE CODE	FIG. 5/8
OLYMPUS OM-2	MOE	
OLYMPUS OPTICAL CO., LTD. TOKYO, JAPAN		

NOTE: WHEN ORDERING FOR SPARE PARTS, PLEASE CLARIFY A MODEL, PARTS NUMBER AND QUANTITY.

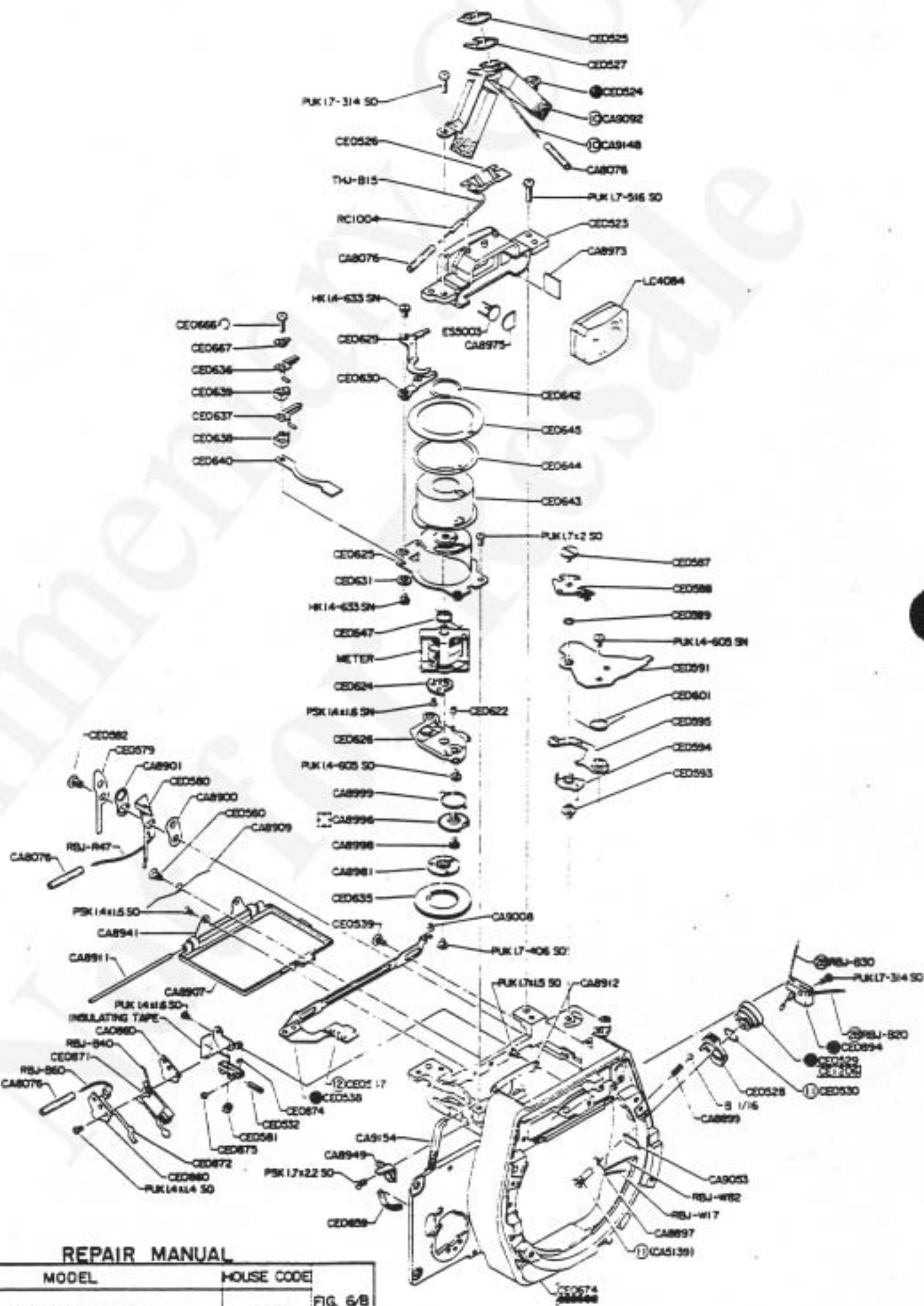

REPAIR MANUAL

MODEL	HOUSE CODE	FIG. 6/B
OLYMPUS OM-2	MDE	
OLYMPUS OPTICAL CO., LTD. TOKYO, JAPAN		

NOTE: WHEN ORDERING FOR SPARE PARTS, PLEASE CLARIFY A MODEL, PARTS NUMBER AND QUANTITY.

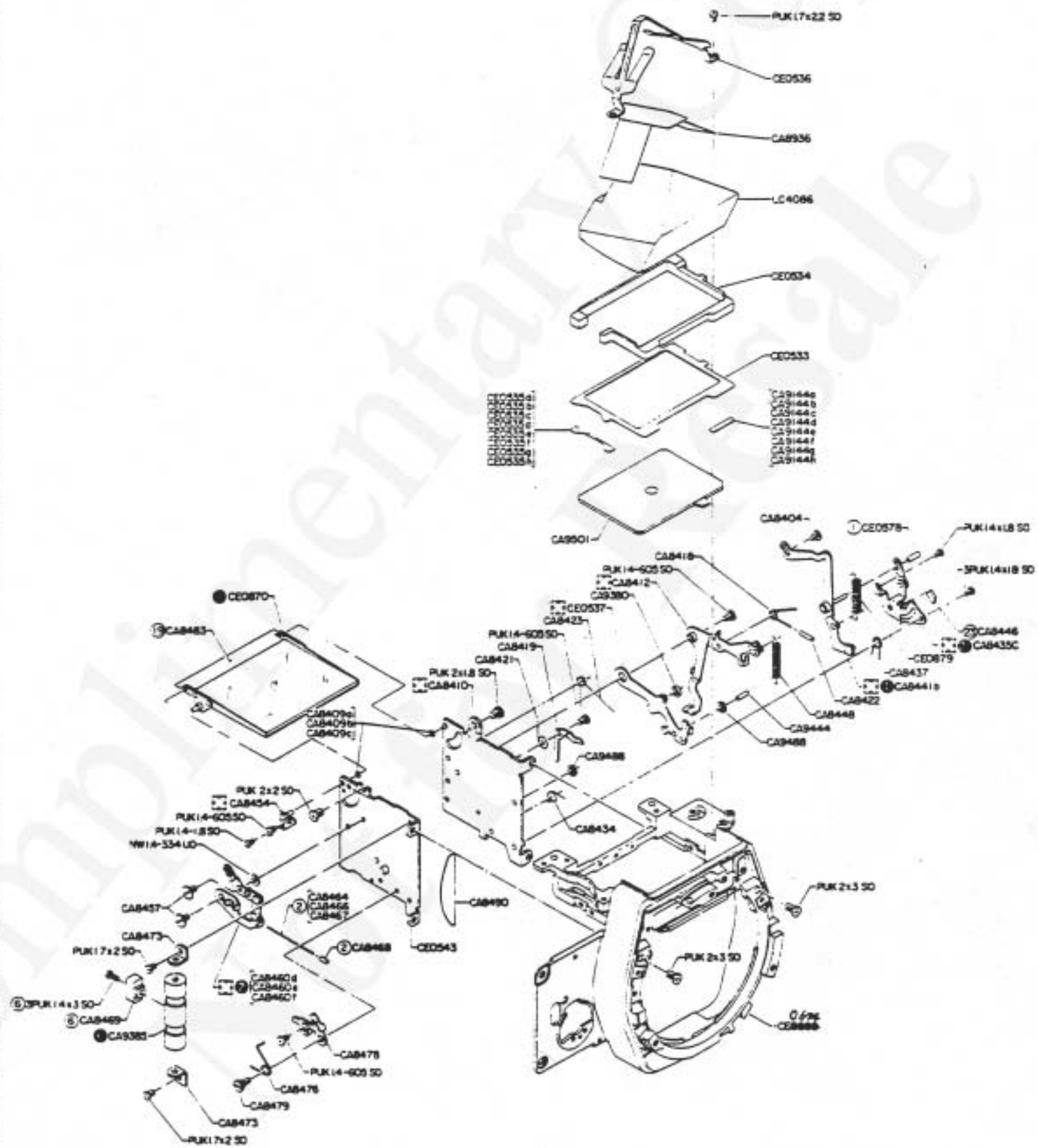

REPAIR MANUAL

MODEL	HOUSE CODE	
OLYMPUS OM-2	MDE	FIG. 7/8
OLYMPUS OPTICAL CO., LTD. TOKYO, JAPAN		

NOTE: WHEN ORDERING FOR SPARE PARTS, PLEASE CLARIFY A MODEL, PARTS NUMBER AND QUANTITY.

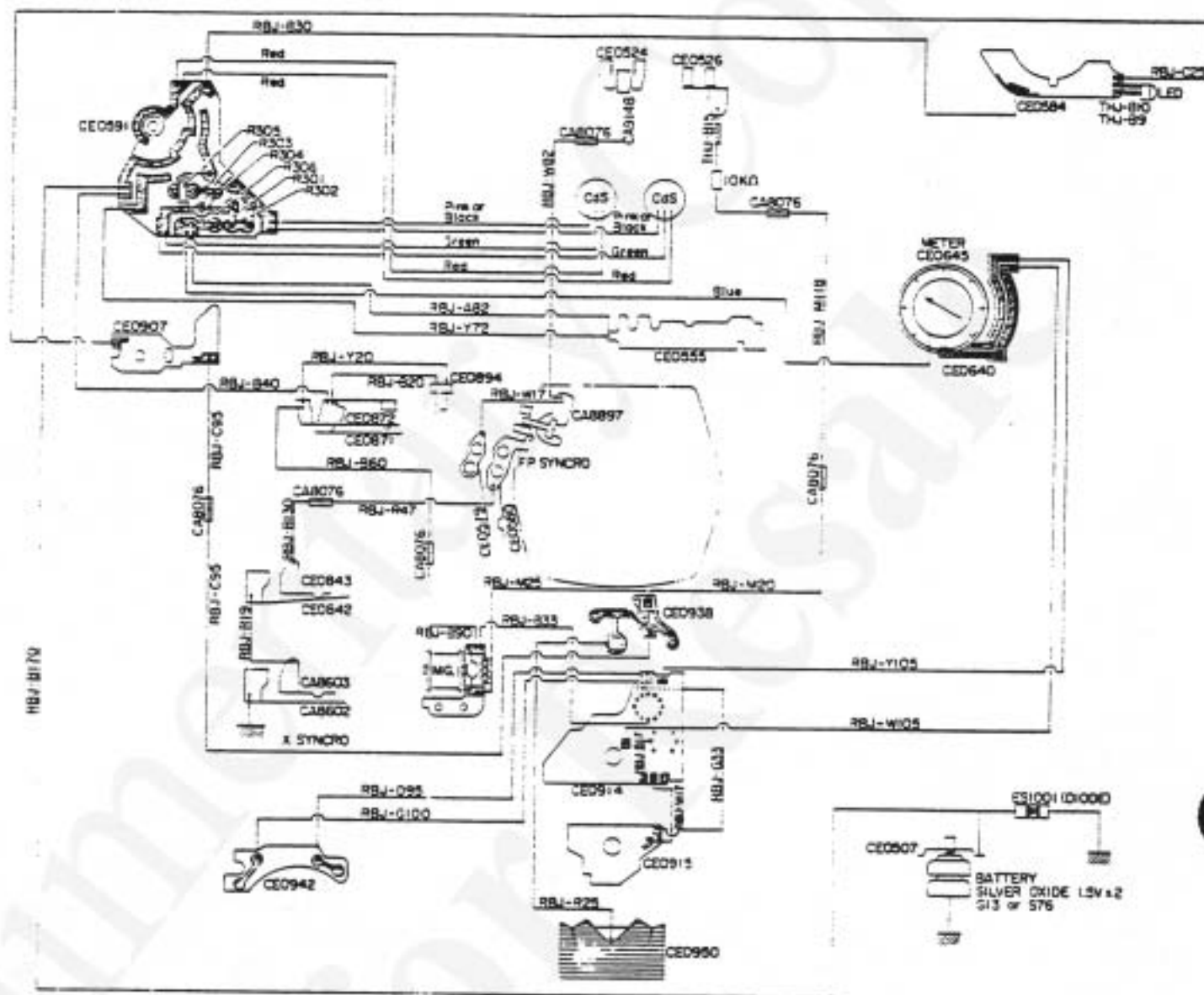

Shutter Circuit Diagram

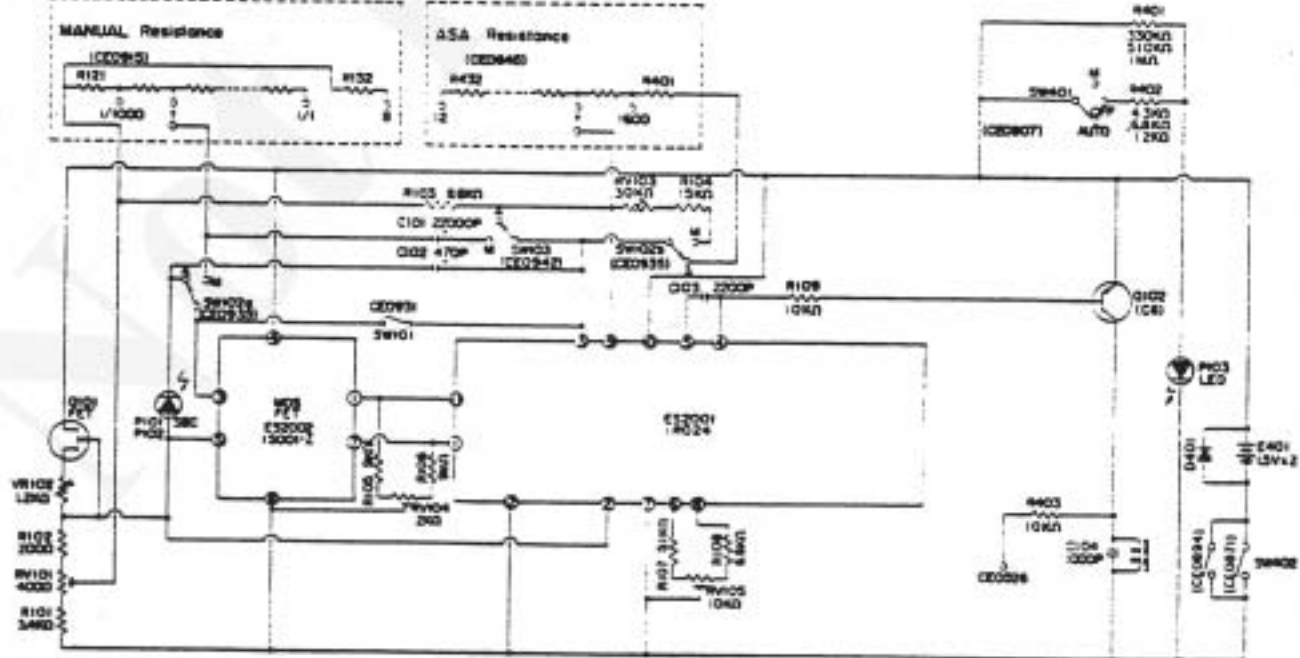

REPAIR MANUAL

MODEL	HOUSE CODE	
OLYMPUS OM-2	MOE	FIG. 8/B
OLYMPUS OPTICAL CO. LTD. TOKYO, JAPAN		

NOTE: WHEN ORDERING FOR SPARE PARTS, PLEASE CLARIFY A MODEL, PARTS NUMBER AND QUANTITY.

PARTS LIST

OM-2

PARTS NO.	NAME OF PARTS	PARTS NO.	NAME OF PARTS
CA 7381	STOPPER SCREW	CA 8586	A LEVER SPRING
7963	RING E	8590	B LEVER SPRING
8076	TUBE	8598	S LEVER WASHER
		8601	STOPPER PLATE
8404	M LEVER SCREW	8602	"X" SYNCHRO CONTACT POINT
8409a	ADJUSTING WASHER a	8603	"FX" SYNCHRO CONTACT POINT
8409b	ADJUSTING WASHER b	8661	TUBE SHAFT A
8409c	ADJUSTING WASHER c	8662	TUBE SHAFT B
8410	LEFT SIDE PLATE	8666	ADJUSTING WASHER
8412	M CHARGING LEVER	8716	R COLLAR SPRING
8418	STOPPER SPRING	8717	KEY A
8419	M HOOKING LEVER	8719	KEY COLLAR
8421	HOOKING LEVER SPRING	8720	KEY COVER
8422	TUBE 2	8722	KEY SPRING
8423	RETURNING SPRING	8724	KEY POSITIONING SCREW
8434	HOOK SPRING	8725	R KNOB
8435c	M BASE PLATE c	8729	R PINCH SET SCREW
8437	MS SPRING	8730	R LEVER PIN
8441b	M LEVER b	8731	R LEVER SPRING
8446	M RING	8732	R LEVER WASHER
8448	CONNECTING LEVER SPRING	8735	R SPRING
8454	M PIVOT	8739	R LEVER WASHER 2
8457	LEVER SHAFT	8740	R LEVER STOPPER 3
8460d	LINK d	8741	FILM COUNTER COVER
8460e	LINK e	8744	STRAP EYELET
8460f	LINK f	8745	LIGHT PROOF L
8463	E RING 08	8746	LIGHT PROOF R
8464	SPRING 1	8747	LIGHT PROOF (LOWER)
8466	SPRING 2	8748	LIGHT PROOF (SIDE)
8467	SPRING 3	8751	FW LEVER COVER
8468	SPRING COVER	8752	FW LEVER HOLDER
8469	PIPE CONNECTOR	8753	FW LEVER DECORATION
8473	PIPE HOLDER (UPPER)	8757	F PLATE
8476	M POSITIONING SPRING	8763	F SPRING
8478	M POSITIONING PLATE	8764	ST IDLE
8479	M POSITIONING SHAFT	8765	IDLE SHAFT
8483	LIGHT PROOF PLATE	8770	SPOOL SPRING
8490	RIGHT COVERING PLATE	8774	FW SPRING
8499	B MASK	8777	FASTENING RING
8508	CURTAIN BASE R	8778	FC RETURNING LEVER
8510	ROLLER A	8779	ST SHAFT
8513	ROLLER HOLDER	8780	SPROCKET HOLDER (UPPER)
8529	ROLLER B	8781	FC GEAR SHAFT
8531	TENSION NUT	8783	FC RETURNING SPRING
8532	TENSION NUT STOPPER	8786	C RING
8535	FELT B	8788	ST GEAR
8541	FELT A	8794	FC PLATE

PARTS LIST

OM-2

PARTS NO.	NAME OF PARTS	PARTS NO.	NAME OF PARTS
CA 8796	L STOPPER	CA 8915	DAMPER #2
8797	WASHER (RUBBER)	8931	PULLEY SHAFT
8806	FW LEVER COVER STOPPER	8933a	RETURNING ROLLER a
8813a	WASHER 1a	8933b	RETURNING ROLLER b
8813b	WASHER 1b	8933c	RETURNING ROLLER c
8815	SPROCKET HOLDER (LOWER)	8933d	RETURNING ROLLER d
8816	GEAR #1	8933e	RETURNING ROLLER e
8817	GEAR #1 SCREW	8933f	RETURNING ROLLER f
8818	GEAR #1 SPRING	8936	P COVER
8819	K CLAW	8939	B SPRING SHAFT
8821b	CHECKING LEVER b	8941	F HINGE
8824b	LOCK LEVER b	8949	B SPRING PLATE
8826	LOCK SPRING	8950	COVERING PLATE
8827	SHAFT #2	8960a	COVERING PLATE WASHER a
8828	GEAR #2 SHAFT	8960b	COVERING PLATE WASHER b
8836	GEAR #3	8969	STOPPER 61
8839	GEAR #4	8973	C LIGHT PROOF
8840	S WINDING PLATE	8975	C COVER
8841	GEAR #4 BASE	8981	M PULLEY HOLDER
8842	KS LEVER	8996	M LOWER PLATE GEAR
8843	SHAFT #4	8998	GEAR SHAFT
8844a	LEVER 1a	8999	GEAR SPRING
8844b	LEVER 1b	9008	PULLEY SCREW
8844c	LEVER 1c	9030	T NUT
8845a	LEVER #2a	9037	P PLATE
8845b	LEVER #2b	9044	K INNER PLATE
8846	LEVER STOPPER	9045	K LEVER SPRING
8847	KS HOLDER	9046	K PLATE HOLDER
8848	KS SHAFT	9047	ST CLAW
8849	KS SPRING	9049	ST SPRING
8851	GEAR #3 SPRING	9051	ST SCREW
8852	SHAFT #4 SCREW	9053	LEVER CUSHION
8854	S RING	9061	ME GUIDE
8857	BASE PLATE SHAFT	9062	COVER SPRING
8859	BULB PLATE SCREW	9063	COVER PIN
8861	RETURNING SPRING	9070	C SCREW
8864	KL SHAFT	9071	S LEVER STOPPER
8872	KM SPRING	9072	ST LEVER
8877	B MOUNT	9074	START LEVER
8888	B MOUNT SPRING	9075	F SPRING
8897	FP SYNCHRO CONTACT POINT	9076	RELEASE BASE NUT
8899	FX SYNCHRO CONTACT SPRING	9077	START LEVER CAP
8900	INSULATING PLATE	9078	S RELEASE PLATE
8901	INSULATING PLATE	9082	S RELEASE BUTTON
8907	F FRAME	9084	SR BUTTON SHAFT
8909	F SPRING	9086	S LEVER PLATE
8911	F SHAFT	9087	D SCREW
3912	F LOCK SCREW	9088	W SPRING

PARTS LIST

OM-2

PARTS NO.	NAME OF PARTS	PARTS NO.	NAME OF PARTS
CA 9092	SM COVER	CA 9375	FW LC
9093	SR BUTTON WASHER	9376	FW GEAR
9094	HINGE PIN HOLDER (UPPER)	9377	FILM GUIDE SCREW
9095	HINGE PIN HOLDER (LOWER)	9378	(COVERING PLATE NO. 3)
9097	HINGE PIN SCREW	9379	3G HOOK SCREW
9098	HINGE PIN A	9380	LEVER COLLAR (RUBBER)
9099	HINGE PIN B	9385	A PIPE
9100	COVERING PLATE	9387	FW SHAFT
9102	LEFT SIDE LEATHER	9388	STOPPER PLATE (UPPER)
9103	RIGHT SIDE LEATHER	9389	STOPPER PLATE (LOWER)
9106	ADJUSTING WASHER NO. 1	9394	PRESSURE PLATE
9107	ADJUSTING WASHER NO. 2	9444	TUBE 3
9111	ST WASHER	9451	M COVER
9112	C WASHER	9472	SW WASHER
9113	GEAR FASTENER	9476	R SHAFT
9134	COVERING PLATE NO. 1	9477	R COLLAR
9135	COVERING PLATE NO. 2	9483	SW BASE PLATE
9141	K PINCH	9487	CLICK SPRING
9144a	FRONT ADJUSTING PLATE a	9488	RUBBER RING 3
9144b	FRONT ADJUSTING PLATE b	9494	FELT C
9144c	FRONT ADJUSTING PLATE c	9501	FOCUSING SCREW
9144d	FRONT ADJUSTING PLATE d		
9144e	FRONT ADJUSTING PLATE e	CE 0501	(DIE CAST BODY)
9144f	FRONT ADJUSTING PLATE f	0502	FRONT CASTING
9144g	FRONT ADJUSTING PLATE g	0503	TOP COVER
9144h	FRONT ADJUSTING PLATE h	0504	BOTTOM PLATE
9146b	SPOOL SHAFT b	0505	BATTERY COMPARTMENT LID
9148	LEAD WIRE (45mm long, BLACK)	0506	COVERING SEAL
9150	R LEVER	0507	B COVER
9151	R PINCH	0509	B CONTACT POINT
9154	LIGHT PROOF PADDING (UPPER)	0510	INSULATION COVER
9155	FRONT CASTING SET SCREW	0511	B HOUSING
9156	LIGHT PROOF PADDING M	0512	COLLAR
9162	K BASE PLATE	0513	SPOOL B
9170	ADJUSTING WASHER 3	0514	TRIPOD BASE
9174	LEVER SHAFT	0515	KM LEVER
9175	M HOLDER	0516	FC RETURNING LEVER
9176	LEVER SHAFT WASHER	0517	FC GEAR
9180	FILM WINDING LEVER	0519	FRONT COVERING PLATE
9181	LEVER WASHER	0520	SHUTTER DIAL
9183	FILM COUNTER GEAR	0521	DIAL GEAR
9185	COUNTER SPRING	0522	CONNECTING RING
9186	FC BASE PLATE	0523	S FRAME
9187	R LEVER WASHER	0524	S BASE
9192	ADJUSTING PLATE	0525	S INSULATING WASHER
9370	SPROCKET	0526	S CONTACT POINT
9372	SPOOL HOLDER	0527a	T WASHER a
9374	M LEVER SHAFT	0527b	T WASHER b

PARTS LIST

OM-2

PARTS NO.	NAME OF PARTS	PARTS NO.	NAME OF PARTS
CE 0528	FX SINCHRO KNOB	CE 0587	SLIDE SCREW
0529	SINCHRO SOCKET	0588	SLIDE PLATE
0530	P STOPPER SPRING	0589	SLIDE HOLDER
0531	BUTTON COVER	0591	SW CIRCUIT BOARD
0532	FP SCREW	0593	CAM SHAFT
0533	MASK	0594	CAM S
0534	PRISM WASHER	0595	CHENGE LEVER
0535a	REAR ADJUSTING PLATE a	0601	RETURNING SPRING
0535b	REAR ADJUSTING PLATE b	0602	B STRING 1
0535c	REAR ADJUSTING PLATE c	0603	B STRING 2
0535d	REAR ADJUSTING PLATE d	0604	SPRING HOLDER
0535e	REAR ADJUSTING PLATE e	0606	A DIAL
0535f	REAR ADJUSTING PLATE f	0607	RUBBER RING
0535g	REAR ADJUSTING PLATE g	0608	CLICK RING
0535h	REAR ADJUSTING PLATE h	0609	L NUT
0536	P STOPPER	0610	LOCK SPRING
0537	CONNECTING LEVER	0614	CAM SPRING
0538	SLIDER	0618	A CAP
0539	SL SHAFT	0619	A PLATE
0543	RIGHT SIDE PLATE	0620	MK PLATE
0544	GUIDE PLATE	0621	EV PLATE
0546	SL CONTACT	0622	INSULATION SHAFT
0547	INDICATION PLATE	0623	COVERING PLATE
0550	ROLLER	0624	M GEAR 2
0551	ROLLER SCREW	0625	M BASE
0552	RIGHT SIDE PLATE	0626	M LOWER PLATE
0553	COVERING PLATE.	0629	A LEVER 1
0555	CIRCUIT BOARD B	0630	A LEVER 2
0557	SPRING	0631	WASHER
0559	B SPRING	0635	PULLEY M
0560	F SPRING SHAFT	0636	A CONTACT 1
0561	STOPPER	0637	A CONTACT 2
0562	S LEVER	0638	CONTACT BASE 1
0563	SW WASHER	0639	CONTACT BASE 2
0565	NUT	0640	BASE PLATE A
0566	C BASE PLATE	0642	C WASHER
0567	K LEVER	0643	A CAM
0570	INSULATING WASHER	0644	WASHER
0574	C SPRING	0645	AR BASE PLATE
0575	S BASE COVER	0647	ST SPRING
0578	SR TUBE	0648	REAR RIGHT SIDE LEATHER
0579	F CONTACT (UPPER)	0649	REAR RIGHT SIDE LEATHER
0580	F CONTACT (LOWER)	0650	RESET BUTTON
0581	F NUT	0652	HOOK SHAFT
0582	F SCREW	0653	HOOK SPRING
0583	CL HOUSE	0654	BL SPRING HOLDER
0584	C CIRCUIT BOARD	0655	BL SPRING
0585	R SHAFT HOLDER	0656	REAR COVER ASS'Y

PARTS LIST

OM-2

PARTS NO.	NAME OF PARTS	PARTS NO.	NAME OF PARTS
CE 0658	HOLDING SPRING	CE 0863	CURTAIN ASS'Y
0659	LIGHT PROOF PADDING (LOWER)	0864	GEAR AB
0660	B NAME PLATE	0865	GEAR PLATE B
0663	SL INSULATING PLATE	0866	REAR CLAW A
0664	CLICK SPRING	0870	M FRAME
0665	INSULATION PLATE	0871	M CONTACT 1
0666	A SCREW	0872	M CONTACT 2
0667	INSULATION PLATE	0874	M INNER PLATE
0674	FRONT CASTING	0875	M TUBE
0675	S DIAL	0879	M SPRING
0676	BL LEVER	0882	M RELEASE
0801	S BASE PLATE	0883	MR SHAFT
0805	HOOK LEVER	0885	TURN PLATE A
0808	SPRING A	0886	TURN PLATE B
0811	HOLDING PLATE	0887	TURN COLLAR
0812	MG BASE	0888	TURN SCREW
0813	MG PLATE	0889	SPRING STOPPER
0819	SPRING B	0891	TURN SPRING A
0820	TR PLATE	0892	TURN SPRING B
0822	T TUBE	0894	M2 WASHER
0823	REAR SHAFT	0901	PLATE L
0824	REAR NUT	0902	C CAM
0825	S PLATE (UPPER)	0904	C LEVER
0826	B LEVER	0906	C SHAFT
0828	B SPRING	0907a	C BASE a
0829	SPEED GEAR	0907b	C BASE b
0832	FIRST CLAW A	0907c	C BASE c
0833	FIRST CLAW B	0909	C PLATE 1
0835	FIRST SHAFT	0910	C PLATE 2
0836	FIRST SPRING A	0911	C BOSS
0837	FIRST SPRING B	0913	C PLATE 3
0838	B LEVER SCREW	0914	M CURCUIT BOARD
0839	M LEVER	0915	S CURCUIT BOARD
0841	M SPRING	0916	CAM SHAFT
0842	X CONTACT A	0917	PLASTIC CAP
0843	X CONTACT B	0918	CAM NUT
0847	LOCK LEVER	0919	C SPRING 2
0848	SL LEVER	0920	BASE TUBE
0851	A LEVER 2	0921	INSULATING PLATE
0852	B LEVER 2	0922	PLASTIC NUT
0853a	KL PLATE a	0923	SCREW
0853b	KL PLATE b	0924	STOPPER
0854	B PLATE	0925	SPEED PLATE
0855	F MASK	0926	POSITION NUT
0856	MASK STOPPER	0928	B SCREW
0860	STOPPER PLATE	0930	T FASTENER
0861	GEAR SCREW	0931	T CONTACT A
0862	B STOPPER RING	0932	T CONTACT B

PARTS LIST

OM-2

PARTS NO.	NAME OF PARTS	PARTS NO.	NAME OF PARTS
CE 0935	K CONTACT		<u>RESISTOR</u>
0938	SUB CIRCUIT BOARD		RM 1704
0940	STOPPER		1804
0941	C BASE PLATE		1805
0942	C BASE		1904
0944	C COLLAR		2004
0945	C TUBE		2203
0946	C SPRING 3		2204
0949	RM PLATE		2304
0952	L BASE		2403
0955	COVERING PLATE		2404
0956	LOWER COVER		2504
LC 4084	EYE PIECE LENS		2604
4086	PENTAPRISM		2703
	EXPOSURE METER ASS'Y		2704
			2705
V 40	SELF TIMER		2804
			2904
			3004
ES 1001	DIODE		3104
2001	IR-024		3204
2002	IS-001Z		3303
5002	L E D		3304
5003	C d S		3404
QK 2030	F E T		3504
			3604
			3903
	<u>CONDENSER</u>		4303
	KC 1003		4702
	KC 4702		4703
	KT 2204		4705
			5103
			5603
	<u>RESISTOR</u>		6203
	RC 1004		9103
	RC 7174		
	RM 1004		<u>LEAD COIL</u>
	1005	RBJ-A82	Blue
	1104	-B17	Black
	1204	-B20	Black
	1304	-B30	Black
	1404	-B33	Black
	1503	-B40	Black
	1504	-B60	Black
	1604	-B90	Black
		-B170	Black

PARTS LIST

OM-2

PARTS NO.	NAME OF PARTS	PARTS NO.	NAME OF PARTS
	<u>LEAD COIL</u>		<u>SET SCREW</u>
RBJ-C25	Brown		PUK1.7x 2.5SN
-C95	Brown		PUK1.7x 5 SN
-D95	Orange		PUK1.7x 8 SO
-G100	Green		PUK1.7-236SO
-M20	Purple		PUK1.7-314SO
-M25	Purple		PUK1.7-406SO
-M118	Purple		PUK1.7-516SO
-R19	Red		
-R25	Red		PUK2x1.8SO
-R47	Red		PUK2x2 SO
-R130	Red		PUK2x2.2SO
-G33	Green		PUK2x2.5SO
-W17	White		PUK2x3 SO
-W82	White		PUK2x4.5SG
-W105	White		
-Y20	Yellow		PSK1.4x1.6SO
-Y25	Yellow		PSK1.4x1.6SN
-Y72	Yellow		PSK1.4x2 SO
-Y105	Yellow		PSK1.4x2.5SO
	<u>TUBE</u>		PSK1.7x1.8SO
THJ-B9	Black		PSK1.7x2.2SO
-B10	Black		PSK1.7x2.5SO
-B18	Black		PSK1.7x2.5SB
	<u>SET SCREW</u>		PSK1.7x3 SO
	PUK1.4x 1.4SO		PSK1.7x3.5SO
	PUK1.4x 1.6SO		PSK1.7x4 SB
	PUK1.4x 1.8SO		
	PUK1.4x 3 SO		PSK2x2 SO
	PUK1.4-310SO		PSK2x2.2SO
	PUK1.4-311SO		PSK2x2.8SO
	PUK1.4-404ST		PSK2x3 SO
	PUK1.4-605SO		PSK2x3.5SE
	PUK1.4-605SN		
	PUK1.4-609SO		3 PUK1.4x1.8SO
	PUK1.4-610SO		3 PUK1.4x3 SO
			3 PUK1.7x2.5SO
	PUK1.7x 1.5SO		3 PUK1.7x5 SN
	PUK1.7x 1.6SO		3 PUK1.7x3 SO
	PUK1.7x 1.8SO		
	PUK1.7x 2 SO		<u>BALL</u>
	PUK1.7x 2.2SO		B 1
	PUK1.7x 2.5SO		B 1/16
			B 2

PARTS LIST

OM-2

PARTS NO.	NAME OF PARTS	PARTS NO.	NAME OF PARTS
	<u>SET SCREW</u>		<u>BLACK FINISH</u>
	HK1.4-101BO	CA 9073b	S BASE COVER
	HK1.4-102BO	9403	R KNOB
	HK1.4-201SN	9404	R LEVER
	HK1.4-338BO	9405	R LEVER WASHER
	HK1.4-341BO	9408	R PINCH
	HK1.4-633SN	9410	R PINCH SCREW
		9412	LEVER FASTENER
		9413	FASTENER
	<u>WASHER</u>	9425	S LEVER STOPPER
	NW1.4-334UO	9426	SR BUTTON
	NW1.4-434UO	9431	KT HOLDER
	NW1.5-425UO	9432	K PINCH
	NW1.8-230UO	9433	R LEVER WASHER
	NW1.8-325BO	9434	R LEVER WASHER
	NW2.1-240PO	9436	R LEVER WASHER
	NW8.6-2136BO	9441	ST LEVER B
		9471	M CAP
		CE 1201	TOP COVER
		1202	BOTTOM PLATE
		1203	FRONT CASTING
		1204	B COMPARTMENT LID
		1205	SHUTTER DIAL
		1206	SYNCHRO SOCKET
		1207	BUTTON WASHER
		1208	SW WASHER
		1210	A DIAL
		1211	RESET BUTTON
			<u>SET SCREW</u>
			PSK 2x3.5 SH



GENERAL OUTLINE AND MECHANICAL FEATURES

Complimentary Copy
Not for Resale

GENERAL OUTLINE AND MECHANICAL FEATURES

1. GENERAL OUTLINES

HOUSE CORD: MDE

MODEL NAME: OM-2

2. MAIN SPECIFICATIONS

System: OLYMPUS OM System

Camera type: 35mm Single Lens Reflex with automatic exposure control electronic focal plane shutter.

Film format: 24mm x 36mm.

Lens mount: OLYMPUS OM Mount, bayonet type; rotation angle 70°, flange back 46mm.

Shutter: Focal plane shutter, automatic exposure control from several tens of seconds to 1/1,000 second (ASA 100, F1.2, at normal temperature and humidity). Manual exposure: B, 1-1/1,000 sec., ring mounted control.

Synch.: FP.X switch type contact, incorrect flash prevention.

Automatic exposure control: Aperture-preferred automatic exposure control electronic shutter type. TTL Direct Light Measuring System, center-weighted for bright, and averaging for dark conditions. Measuring range: ASA 100 F1.2 from several tens of seconds to F16, 1/1,000 seconds. (about EV-5.5 - EV 18) (at normal temperature and humidity). Light sensors: 2 SBC sensors. Large fine-exposure adjustment dial: ±2EV (within the ASA film speed range). Automatic flash exposure: Direct contacts for TTL Auto Flash.

Manual exposure: TTL type. Measuring system: Full aperture center-weighted metering. Measuring range: EV1.5 - EV17 (ASA 100 with F1.2 standard lens). Light sensors: 2 CdS sensors. Zero-method with needle visible in viewfinder.

Film speed setting: ASA 12 — 1600, set by lifting and rotating film speed dial.

Auto/Manual selection: By switching lever.

Battery check: 3-stage battery check lamp (light emitting diode) indicates full voltage, depleted charge, and exhaustion of batteries. Shutter lock to limit drainage.

Power source: Two 1.5V silver oxide batteries (Eveready (or UCAR) S-76 or equivalents).

Viewfinder: Pentaprism type wide-vision finder.

Focusing screens: Wide selection of interchangeable screens.
Standard type Focusing Screen 1-1 (microprism-matte type).

Finder view-field: 97% of actual picture field.

Apparent field view: Vertical 23°30', horizontal 35°.

Indicators in: 3-stage selector lever. (Auto: Shutter speed indicator. — Manual: exposure index. — Off: nothing).

Reflex mirror: Oversize, quick return type (without lock-up).

Film loading: OLYMPUS easy loading.

Manual film advance: Lever type with 150° angle for one long or several short strokes, pre-advance angle 30°, self cocking, double advance and double exposure prevention.

Motor drive: With Motor Drive 1 unit attached, single frame and continuous advance at speed of 5-frame per second (at exposures above 1/500 sec., with fresh batteries and at normal temperature and humidity).

Exposure counter: Progressive type with automatic reset.

Film rewind: Crank type, with rewind clutch setting, automatic return.

Self-timer: 4 - 12 second delay lever type with 180° maximum angle. stopped and reset after actuation.

Camera back: Removable hinge type. with memo holder.
Interchangeable with Recordata Back 1 and 250 Film Back 1.

Hot shoe socket: OLYMPUS accessory shoe (optional) attachable.

Dimensions and weights:

Body only:	136 x 83 x 50mm (5.35" x 3.27" x 1.97")	520g (18.3 oz)
With F1.8 lens:	136 x 83 x 81mm (5.35" x 3.27" x 3.19")	690g (24.3 oz)
With F1.4 lens:	136 x 83 x 86mm (5.35" x 3.27" x 3.39")	750g (26.5 oz)
With F1.2 lens:	136 x 83 x 97mm (5.35" x 3.27" x 3.82")	830g (29.3 oz)

3. CAUTION

AUTO: At "AUTO", the shutter speed varies automatically in response to the f/stop preselected and lighting conditions regardless of the shutter dial setting, except "B".

To release the shutter lock: When the shutter is locked due to improper battery condition, the lock can be released by resetting the shutter dial. (Align the reset marks, * and arrow, while depressing the reset button. At this point, the shutter dial is set to "B".)

When trouble occurred: If the shutter is locked, the battery shall be depleted quickly. Therefore, release the lock immediately.

4. MECHANICAL FEATURES

CONTENTS

- 1 WX Mechanism
- 2 Shutter Lock and Lock Release
- 3 Automatic Synchronization
- 4 Battery Checker (3-level indication)
- 5 Light Measuring Method
- 6 Shutter Speed Adjusting Mechanism
- 7 Shutter Circuit Diagram
- 8 Description of Each Component
- 9 AUTO Circuit Diagram
- 10 Operation Sequence at AUTO
- 11 Supplementary Description of AUTO Circuit
- 12 Operation Sequence of M Circuit Board at AUTO
- 13 ASA Conversion and Decision Level
- 14 Shutter Curtain and "Off" timing of MG
- 15 MANUAL Circuit Diagram
- 16 Operation Sequence at MANUAL
- 17 Shutter Speed Circuit Board
- 18 Outline of Exposure Meter
- 19 Coupling Mechanism of Aperture Ring and Exposure Meter
- 20 Coupling Mechanism of Shutter Dial and Exposure Meter
- 21 ASA Conversion
- 22 F/stop Conversion

[1] WX Mechanism (Prevention of flashing at 1/125 sec. and faster)

The mechanism, in which the X contact is not turned on for the shutter speeds faster than 1/125 of a second, is called "WX mechanism".

The principle lies in the structure comprising two contact pieces; X₂ coupling with opening curtain and X₁ coupling with closing curtain, wired in series each other. When the shutter is charged, the contact piece X₂ is OFF, while X₁ is ON.

1/60 sec. or slower ----- When the opening curtain fully run, X₂ is turned ON; at this point, the closing curtain doesn't start for a certain time (X₁ remains ON). Both contacts are thus ON at the same time.

1/125 sec. or faster ----- The closing curtain runs before X₂ is turned on. (X₁ is OFF.) Both contacts are thus OFF at the same time.

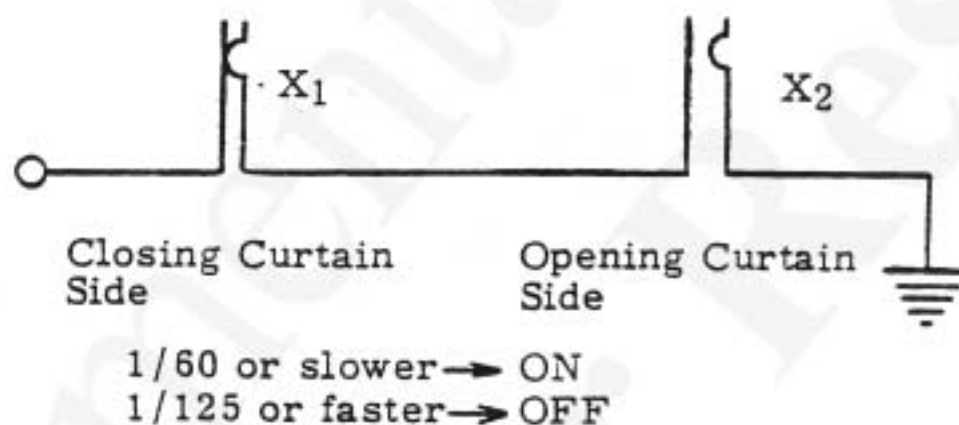

[2] Shutter Lock and Lock Release

When the shutter cannot operate due to battery voltage drop and other battery troubles, the shutter lock is activated and the mirror is locked up midway. To return the mirror to the original position, turn the shutter dial to "B". Thereafter, load fresh batteries correctly. (See CAUTION at the top of this chapter.)

[3] Automatic Synchronization

The shutter of OM-2 is of an electric control type for both auto and manual. Whenever the closing curtain has run, MG (magnet) is turned from ON to OFF.

Since the MG takes a coil form, back electromotive force (caused by self-induction) is generated for the change in the current.

This back electromotive force is utilized to control a special electronic flash unit. Both the OM-2 and the special electronic flash unit are provided with an exclusive synch contact in addition to the conventional direct contact.

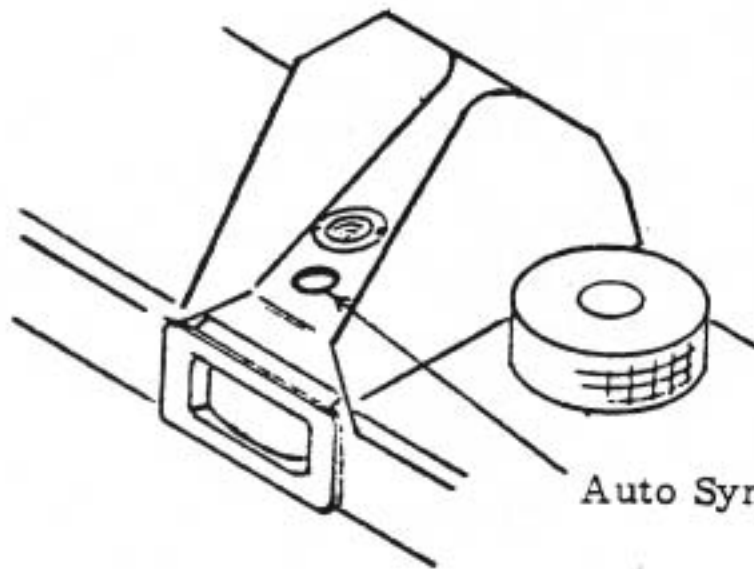

Merit: The flash light is measured based on the TTL method to control amounts of light. This assures real time light measurement and offers an ideal type of automatic flash.

{4} Battery Checker (3-level indication)

When the switching lever is pressed to the "CHECK" position (the lever is automatically returned by releasing the finger), the red light-emitting diode provides three indications of ON, BLINK and OFF depending upon battery voltage.

- QN Normal (battery voltage 2.75V or higher)
- BLINK Better to replace ($2.75V \pm 0.04V$ or lower)
(Still provides about 20 rolls of 36-frame film.)
- OFF Replace ($2.45V \pm 0.04V$ or lower)

{5} Light Measuring Method

The light measurement is performed through two CdSs in the eyepiece section and two SBCs (Silicon Blue Cell) in the mirror box, making a total of four light sensors.

The CdSs in the eyepiece section are connected only to the exposure meter visible in the viewfinder, and plays a role of controlling the pointer of the exposure meter.

The SBCs in the mirror box are used to measure the light at AUTO to control the shutter speed.

The SBCs face the film plane to measure the reflected light from the film surface (from shutter curtain at high shutter speeds).

Since the SBCs measure substantially the reflected light from the opening curtain at high shutter speeds, the shutter curtain is printed with a "random pattern" designed to achieve correct exposures. (Take care not to leave finger marks, nor smudge the curtain.)

The main switch of the SBCs is turned on when the shutter button is depressed and the mirror is being flipped up. The SBC's quick reaction speed (μ sec order) amply assures the control of shutter speed which is about 1/1000 sec. at the highest.

Therefore, unlike other single-lens reflex cameras with electronic shutter, the conventional memory device is needless; hence, correct exposures can always be obtained even when the subject or scene varies its brightness at the moment of shutter opening.

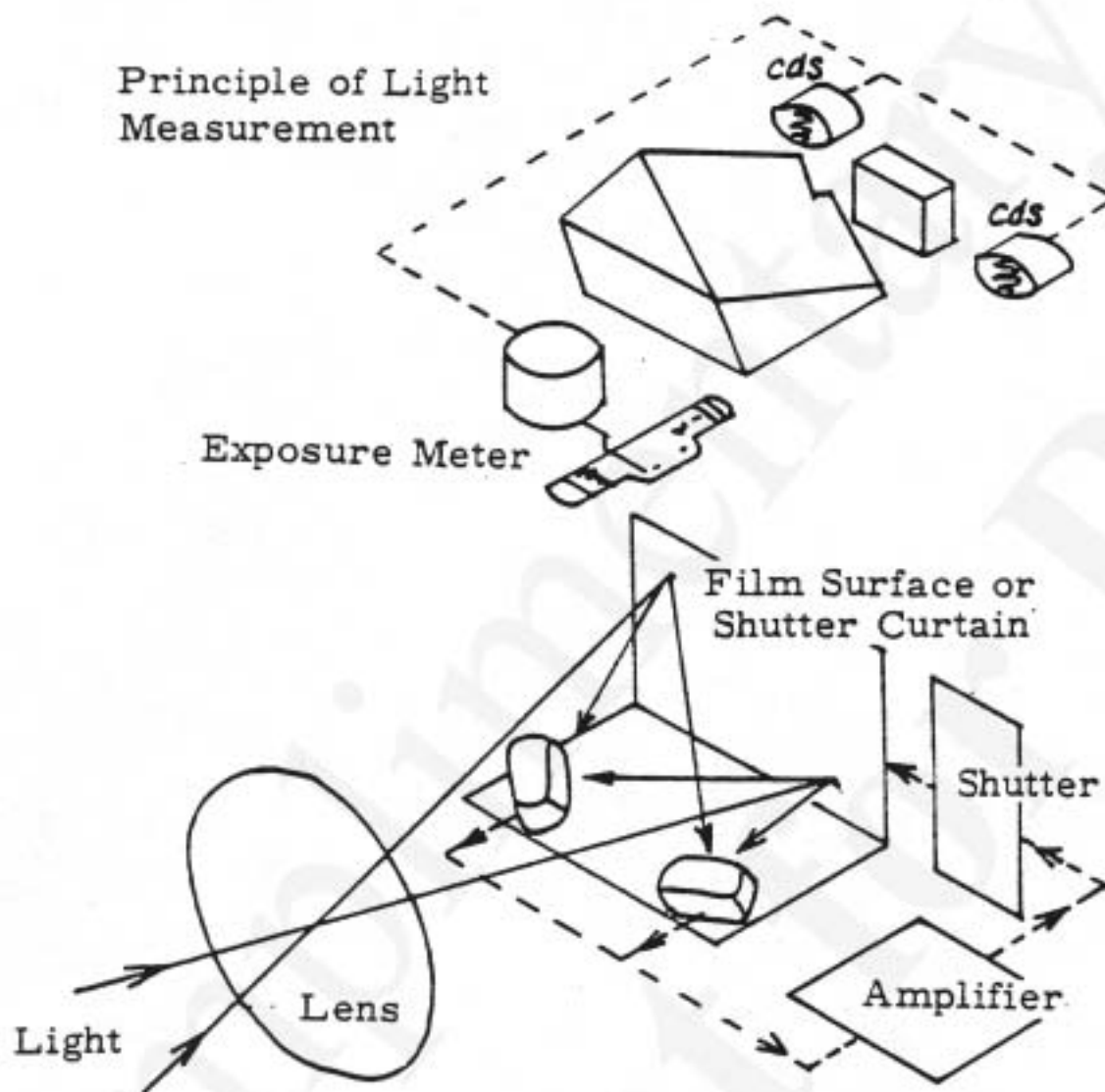

Reflectance variations of various types of film is approximately $\pm 0.3\text{EV}$.

From among a number of patterns, the random pattern was selected which was found to yield best exposures.

[6] Shutter Speed Adjusting Mechanism

The shutter speed adjustment is done with a mechanical governor in OM-1. but is done with an electric governor (MG + Amplifier) in OM-2. The operation principle of the opening and closing curtains is as follow.

Opening Curtain ... Winding and running are performed with CA8547 (Gear A), same as in OM-1.

Closing Curtain ... The curtain is wound with CE0802 (Gear B). the gear is engaged by MG attractive force and the shutter speed is adjusted by amplifier. The OM-1 governor is replaced by MG and amplifier; others are same as in OM-1.

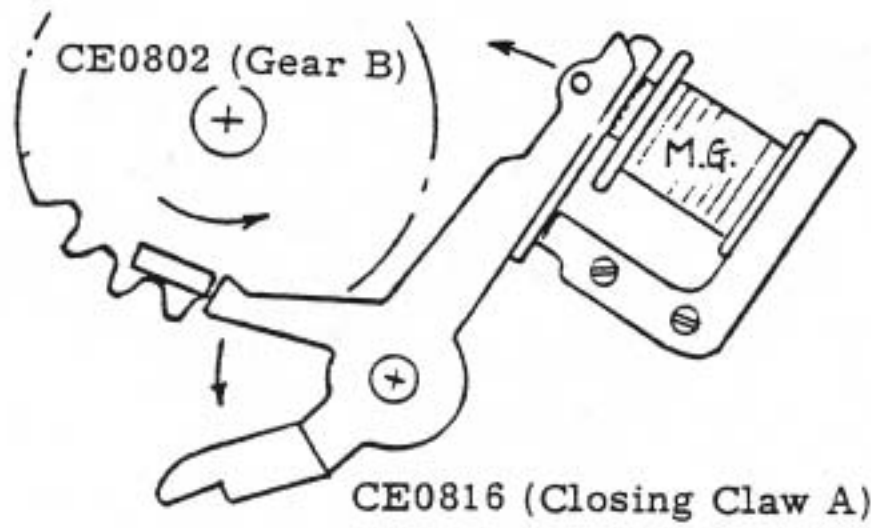

When MG is turned off, CE0816 (Closing Claw A) is disengaged from CE0802 (Gear B), CE0802 rotates in the arrow direction due to the tension of the closing curtain and the closing curtain starts running.

[7] Shutter Circuit Diagram

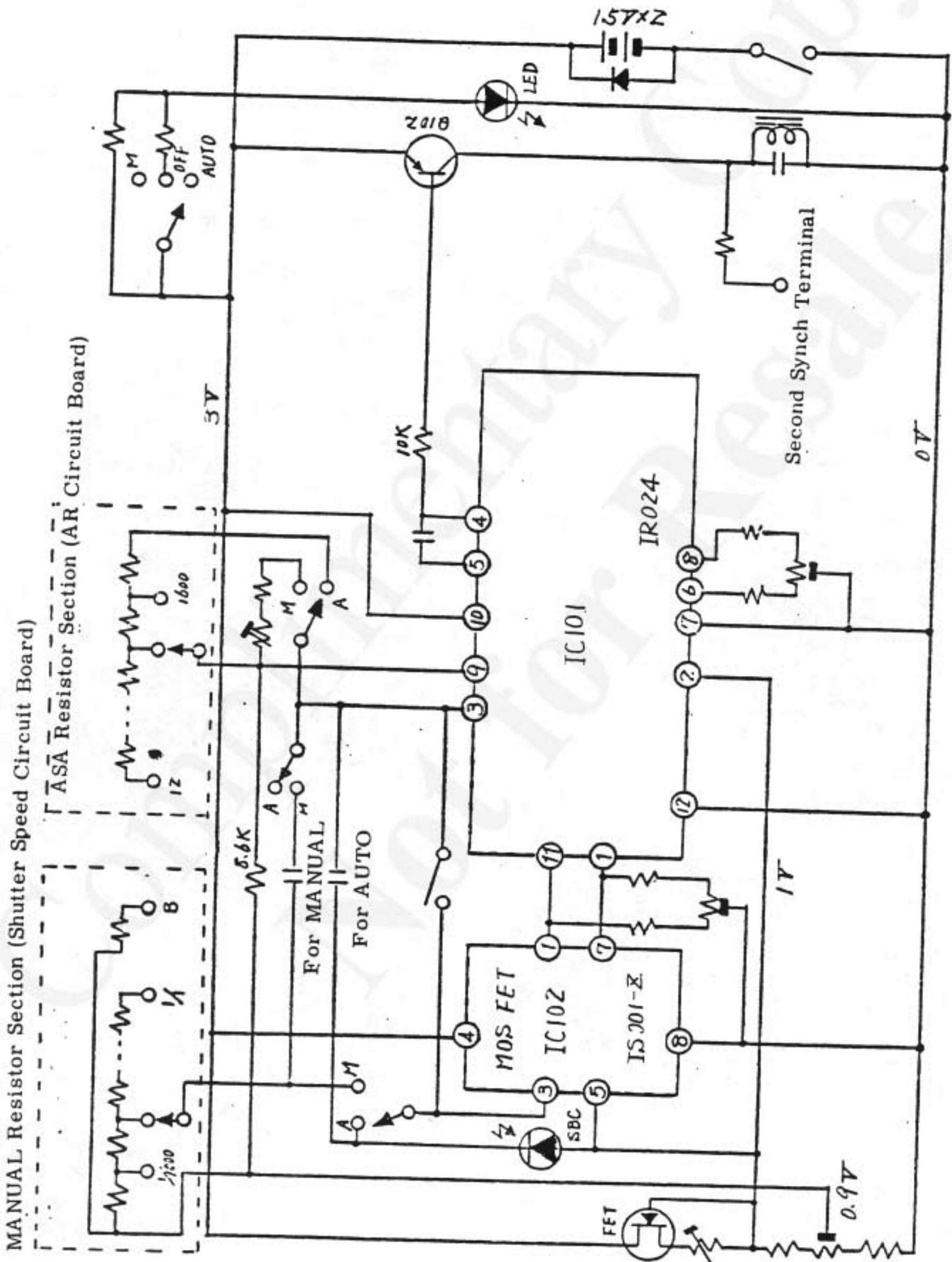

[8] Description of Each Component

(1) IR 024 (IC 101)

This IC includes four circuits: a) integration circuit, b) comparator, c) sub circuit and d) limiter.

a) Integration Circuit

 This is also called an operational circuit. It makes the condenser to charge at a rate such that the relation between charging quantity and time can be expressed in a linear formula (straight line if expressed graphically). ($i = i'$; if i is constant, i' will also be constant.) When connected as in the illustration below, it acts to flow the current to the output pin ③ so that potential difference between two input pins ① and ② shall always becomes zero.

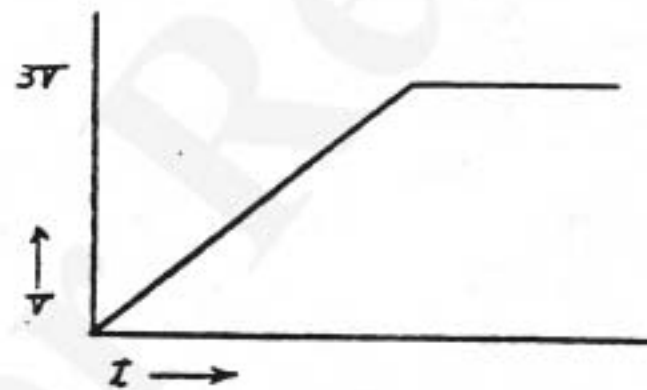
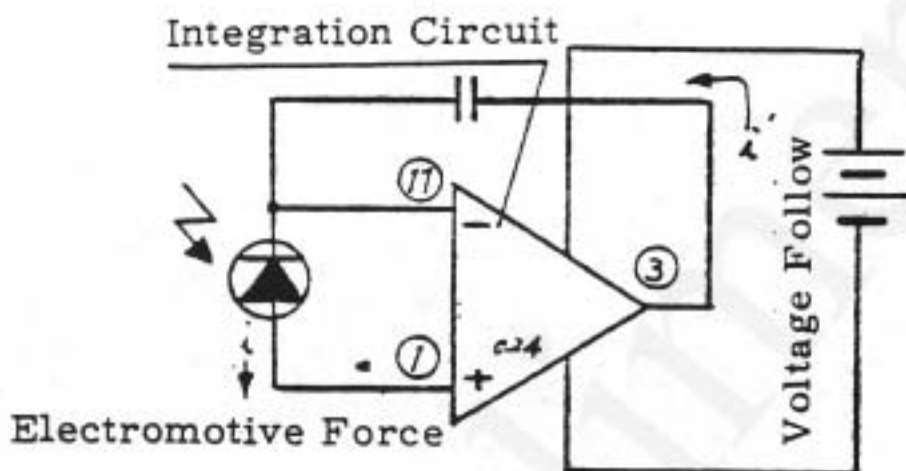

Relation between V and t of condenser is expressed by a straight line because of integration circuit.

b) Comparator

This is connected next to the integration circuit. The comparator acts to decide whether the electric signal transmitted has a potential greater than the rated voltage, and switches its output from 0V to 3V if the potential is greater than the rated voltage. The terminals for input electric signal consist of pins ⑨ and ②, while the output terminal of ④. (As the potential difference of 3V is generated between the base (B) and emitter (E) of the switch transistor Q102 at a 0V output. MG is turned on. When the output is switched to 3V, MG is turned off because potential difference between B and E becomes zero.)

See Shutter Circuit Diagram in the preceding page.

c) Sub circuit

When battery power is depleted, the limiter described below operates to turn off the MG and the shutter is locked. However, if this condition were left as it is, the battery would recover and MG would repeat turning on and off. To prevent this, the sub circuit operates to shunt large current.

d) Limiter

When battery voltage drops below the rated value, the limiter operates to eliminate the potential difference between base and emitter to prevent turning on of MG.

(2). MOS FET (Metal-Oxide-Semiconductor Field-Effect-Transistor)



This is connected between SBC and IC 024. Insulation resistance* on the input side of the integration circuit of IC 024 cannot be made due to structural reason. Thus, extremely weak currents like SBC's (approx. 10^{-11} A) cannot be dealt with accurately. MOS FET has a very high insulation resistance on its input interface, so that it can accurately catch the extremely weak currents and amplifies and sends them to the integration circuit.

* Correctly, input impedance
MOS FET is destroyed with static electricity of 100V, so must be grounded.

(3) FET



This functions to make flow of electric current constant even when the battery voltage fluctuates, and makes the voltage constant. It is provided with 3 pins: source (S), drain (D) and gate (G). When the voltage between S and G is changed, the current flowing from D to S is changed.

(4) SBC (Silicon Blue Cell)



This is a photo-sensitive element, which generates electromotive force when receiving light.

Features

1. Very quick response speed (10^{-5} - 10^{-6} sec.) enables real time and unremitting light measurement.
2. Dark current is weak and accuracy on the low luminance level is high.
3. Electromotive current caused by incident light changes linearly ($\gamma = 1$).

therefore easy to compute.

4. Blue filter applied lowers the infrared-ray rate to below 14%.

(5) Condenser

This plays an important role of deciding the exposure time. The potential between its electrodes is 0V before charging, and is increased in proportion to charging. When the charging current is large (i.e. when the subject or scene is bright), the voltage increase is rapid. Due to the integration circuit, the relation between the charging voltage increase and time is linear. Two condensers are provided for the following reason. In the AUTO mode, the current to be handled is weak because of SBC, so the condenser capacity is small. Whereas, in the MANUAL mode, the current value is designed large for safety purposes and the condenser capacity is made larger.

Condenser for AUTO 470 pF

Condenser for MANUAL 22000 pF

In addition to the above, two condensers are used; one for the prevention of comparator oscillation and the other for voltage adjustment of second synchro circuit.

(6) LED (Light-Emitting Diode)



When the shutter is released in a dark place, the LED (positioned underneath SBC) illuminates the SBC to prevent the shutter from being left opened.

Connect (+) side to the anode (A) and (-) side to the cathode (K), respectively.



When the AUTO/MANUAL switching lever is set to the OFF position, the LED is lit brightly and the shutter can be released at about 1/15 sec. and faster even at OFF.

(7) Diode

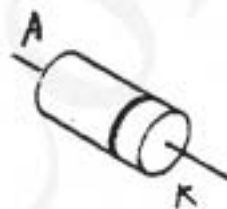

This is connected in the shortest distance between the batteries to prevent current flow when batteries are loaded upside down.



(8) Transistor

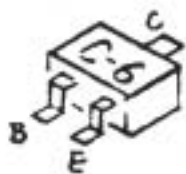

The transistor used in the M circuit board is for turning on and off of the magnet.

