

order manuals online at: realeasybay.com/manuals

Minolta Co., Ltd.	3-13, 2-Chome, Azuchi-Machi, Chuo-Ku, Osaka 541-8556, Japan
Minolta Europe GmbH Reparatur/Repair	Minolaring 11, D-30855 Langenhagen, Germany Senator-Helmken-Strasse 1, D-28197 Bremen, Germany
Minolta France S.A.	365 Route de Saint-Germain, F-78420 Carrières-Sur-Seine, France
Minolta (UK) Limited	7 Tamers Drive, Blakeslands, Milton Keynes, MK14 5BU, England
Minolta Austria Ges. m.b.H.	Amalienstrasse 59-61, A-1131 Wien, Austria
Minolta Camera Benelux B.V.	Zonnebaan 39, P.O. Box 6000, NL-3600 HAMaarsse, The Netherlands
Belgium Branch	Prins Boudewijnlaan 1, B-2590 Kontich, Belgium
Minolta (Schweiz) AG	Riedstrasse 6, CH-8953 Dietikon, Switzerland
Minolta Svenska AB	Albygatan 114, S-171 54 Solna, Sweden
Finland Branch	Nilttykatu 6 PL37, SF-02201 Espoo, Finland
Minolta Portugal Limitada	Av. do Brasil 33-A, P-1700 Lisboa, Portugal
Minolta Corporation Head Office	101 Williams Drive, Ramsey, New Jersey 07446, U.S.A.
Los Angeles Branch	11150 Hope Street Cypress, CA90630, U.S.A.
Minolta Canada Inc. Head Office	369 Britannia Road East, Mississauga, Ontario L4Z 2H5, Canada
Vancouver Branch	230-3771 Jacombs Road, Richmond, B.C. V6V 2L9, Canada
Minolta Hong Kong Limited	Room 208, 2/F, Eastern Center, 1065 King's Road, Quarry Bay, Hong Kong
Minolta Singapore (Pte) Ltd.	10, Teban Gardens Crescent, Singapore 608923
Shanghai Minolta Optical Products Co., Ltd.	368 Minolta Road, Songjiang, Shanghai, China

© 2000 Minolta Co., Ltd. under the Berne Convention and universal Copyright Convention

Printed in Malaysia

9222-2162-21 MM-C009



E INSTRUCTION MANUAL

BASIC OPERATION

DETAILED OPERATION

APPENDIX

order manuals online at: realeasybay.com/manuals



order manuals online at: realeasybay.com/manuals

FOR PROPER AND SAFE USE

Thank you for purchasing a Minolta camera. A valuable tool for photographers, the Maxxum/Dynax 7 has been designed with precision in mind to help you capture your photographic vision. As you use the Maxxum/Dynax 7, you will find that its performance and reliability complement your own photographic expertise and raise your skills to a higher level.

The Maxxum/Dynax 7 features a newly developed 9-point AF system with center dual cross-hair sensors to give great flexibility when composing photographs, and the ability to switch between AF and MF, using the AF/MF control button, without changing holding positions.

This is the first camera ever to incorporate a Navigation display which gives easy to understand information on camera operation and Custom functions, available in 5 languages. Combined with the conventional lever and dial controls, the Navigation display provides flexible and clear operation.

This manual has been designed to help you understand the operation of your camera and its functions. Please familiarize yourself with the names of the controls and their locations on the camera, then read the Basic Operation section. Once you've mastered basic operation, move on to the Detailed Operation section to expand your expertise.

This camera is designed to work specifically with lenses and accessories manufactured and distributed by Minolta. Using incompatible accessories with this camera may result in unsatisfactory performance or damage the camera and accessories.

2

Read and understand all warnings and cautions before using this product.

WARNING

- Batteries may become hot or explode due to improper use.
- Use only the batteries specified in this instruction manual.
 - Do not install the batteries with the polarity (+/-) reversed.
 - Do not subject batteries to fire or high temperatures.
 - Do not attempt to recharge, short, or disassemble.
 - Do not mix batteries of different types, brands, or ages.
 - Tape over lithium battery contacts to avoid short-circuit when disposing of batteries, and follow local regulations for battery disposal.

Keep batteries and other things that could be swallowed away from young children. Contact a doctor immediately if an object is swallowed.

- Immediately remove the batteries and discontinue use if...
- the camera is dropped or subjected to an impact in which the interior is exposed.
 - the camera emits a strange smell, heat, or smoke.

Do not disassemble. Electric shock may occur if a high voltage circuit inside the camera is touched. Take your camera to a Minolta Service Facility when repairs are required.

Do not look directly at the sun through the viewfinder.

CAUTION

Do not allow a camera lens to point directly at the sun. Fire may occur if sunlight comes to focus on a flammable surface. Replace the lens cap when the product is not being used.

3

order manuals online at: realeasybay.com/manuals

TABLE OF CONTENTS

Table of Contents	4	Metering	
Name of Parts	8	Selectable Metering	74
Quick Operation	14	Exposure Compensation	77
BASIC OPERATION		Automatic Exposure Lock (AEL).....	81
Batteries	17	Setting the ISO Manually.....	86
Loading Film.....	20	Drive	
Handling the Camera	23	Continuous	88
Taking Pictures in Full-Auto	24	Self-Timer.....	90
Focusing.....	28	Exposure Bracketing.....	92
Using the Built-in Flash	31	Multiple Exposure	96
Rewinding the Film.....	33	Flash	
DETAILED OPERATION		Flash Mode Switch	99
Navigation Display	36	Red-eye Reduction	100
Display Selection	37	Rear flash Sync	101
When Upper Part Turns Black	43	Slow-shutter Sync.....	102
Display Brightness/Contrast	44	Flash Compensation.....	103
Focusing		Flash Bracketing.....	104
Focus Mode	46	Accessory Flash	107
AF/MF Control Button.....	50	Flash Metering	108
Focus Area.....	53	High Speed Sync	110
AF Illuminator.....	59	Wireless/Remote Off-camera Flash.....	112
Exposure		PC Terminal.....	118
P Mode.....	61	Additional Features	
A Mode.....	63	Date/Time Imprinting.....	120
S Mode	66	Eye-Start	125
M Mode.....	69	Time Exposures (Bulb)	126
		Depth-of Field Preview	128
		Diopter Adjustment	130
		Setting/Canceling the Audio.....	131

order manuals online at: realeasybay.com/manuals

TABLE OF CONTENTS

Memory		18	Exposure compensation control with rear control dial in P, A, and S mode
Storing memory	135		
Recalling settings in memory.....	137	19	Control dial - exchanged control
Data memory		20	Flash-metering
Storing the data	141	21	AF illuminator
Film area and data number	143	22	Tasking on the focus-mode switch - AF-A position
Data recall.....	146	23	AF using shutter-release button
Deleting stored data.....	151	24	Full-auto mode of the exposure-mode dial
Custom Functions		25	Tasking on exposure mode dial - position "3"
1	AF priority/Shutter-release priority	26	Flash burst with exposure compensation
2	Film rewind start	27	Detailed display
3	Film tip	28	Operation display
4	DX memory	29	Large icon display
5	Release lock (film)	30	Meter index display
6	Lens focus-hold button	31	Exposure-history display
7	Eyepiece sensor activation	32	Vertical display
8	Frame counter	33	Imprint intensity
9	AF/MF control button	34	Camera's ID number
10	AE-lock button	35	Language on navigation display
11	Exposure bracketing/Flash bracketing sequence		
12	Film rewind speed		
13	Meter display duration		
14	AF area display		
15	Front and rear control dial Lock		
16	Release lock (lens)		
17	AF drive speed		

APPENDIX	
Accessory information	189
Trouble shooting	192
Care and Storage	196
Specifications.....	198
Index	202

order manuals online at: realeasybay.com/manuals

NAMES OF PARTS

For information on specific parts, refer to the page numbers shown in parenthesis.

Camera Body

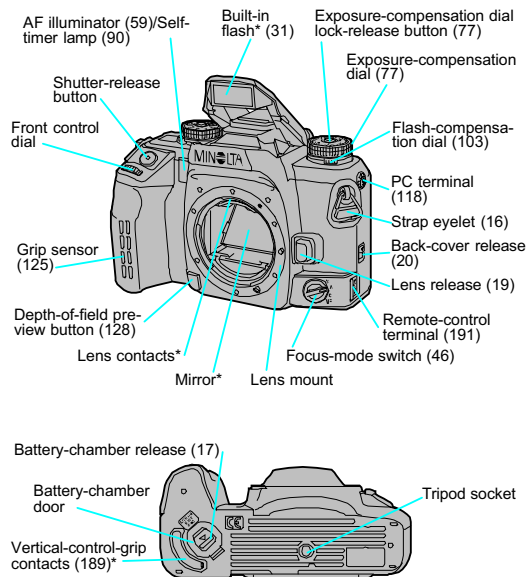

* Do not touch
8

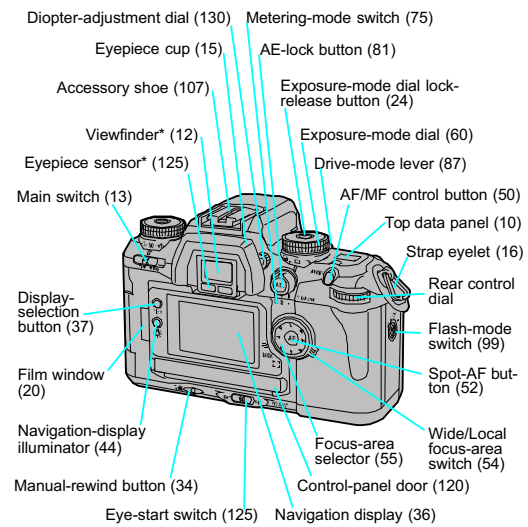

9

order manuals online at: realeasybay.com/manuals

NAMES OF PARTS

Control Panel

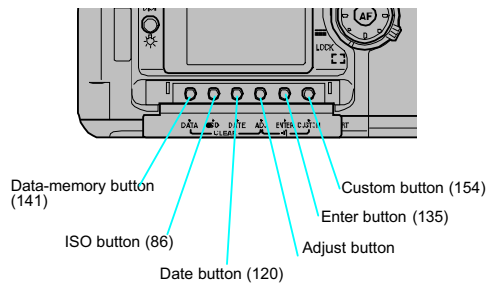

Top Data Panel

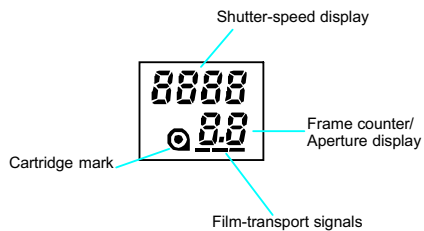

10

Navigation Display

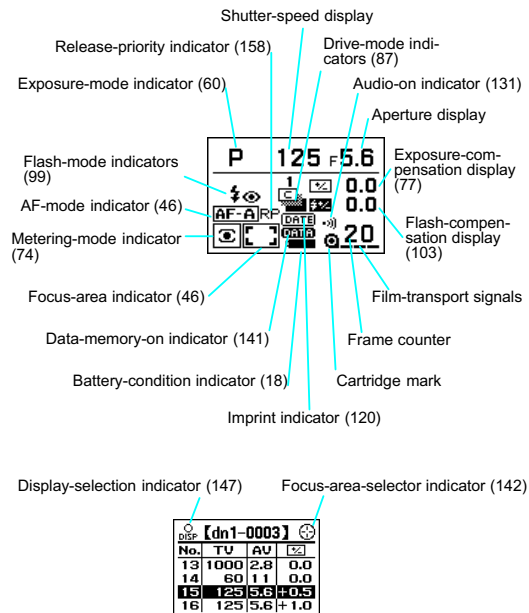

11

order manuals online at: realeasybay.com/manuals

NAMES OF PARTS

Viewfinder

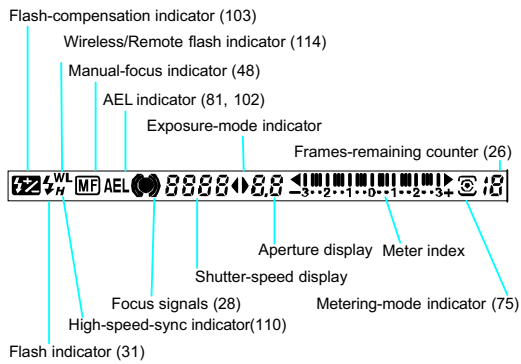
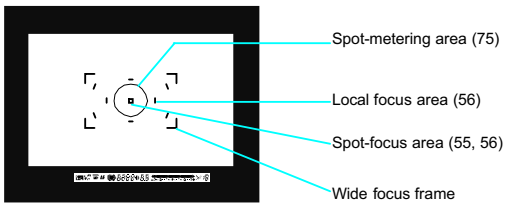

QUICK OPERATION

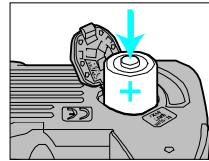

- 1. Insert the batteries.**
 - The camera uses two CR123A batteries.

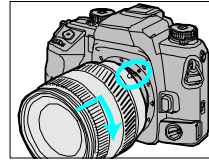

- 2. Attach a lens.**
 - Align the red marks, then turn it gently clockwise until it clicks.

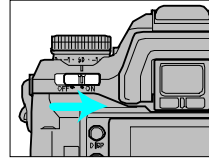

- 3. Turn the camera on.**
 - Turn the main switch to ON.

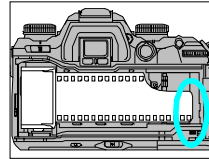

- 4. Load the film**
 - Align the film-tip with the red mark, then close the back cover.

order manuals online at: realeasybay.com/manuals

QUICK OPERATION

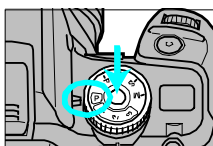

5. Set the camera for automatic operation.

- While pressing the exposure-mode dial lock-release button, set the exposure-mode dial to **P**.

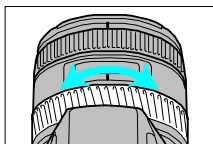

6. If using a zoom lens, rotate the zooming ring to frame your subject as desired.



7. Center your subject in the focus frame, then press the shutter-release button partway down.

- Focus is set automatically.

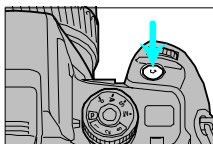

8. Take the picture.

- Gently press the shutter release button all the way down.

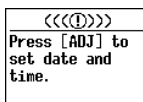

If the camera is turned on and the date and time have not been set, this message appears. See page 121 for instructions for setting the date and time.



The navigation display panel can provide information in any one of five languages (Japanese, English, German, French, or Spanish). To select the language you wish to use, see Custom 35 (p. 187).

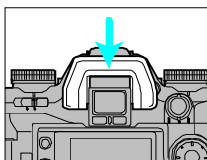

Attach the eyepiece cup for comfortable viewing.

order manuals online at: realeasybay.com/manuals

BASIC OPERATION

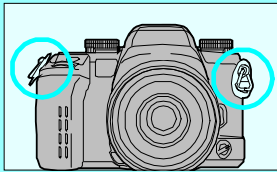

Attach the strap as shown.

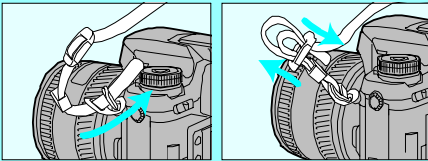

• If you have Remote Cord RC-1000S or RC 1000L, you can use the cord holder on the strap. Attach the strap so that the holder comes to the side of the remote-control terminal (p. 191).

16

BATTERIES

Installing the Batteries

Your camera uses two 3V CR123A lithium batteries to supply power for all camera operations.

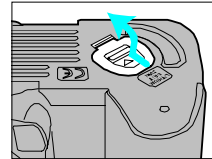

1. Turn the main switch off. Then slide the battery chamber release as shown, and open the door.

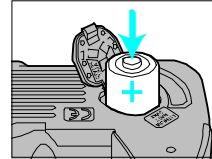

2. Insert the batteries as indicated by the + and - marks.
3. Close the battery-chamber door.

((()))
Press [ADJ] to set date and time.

If the camera's batteries are removed for a long period of time, the date and time settings will be lost. When this happens, this message appears, and the date/time information will not be imprinted. See page 121 for instructions for setting the date and time.

BASIC OPERATION

17

BATTERIES

Battery Condition Indicators

The battery condition indicator displays the power status of the batteries when the main switch is set to ON.

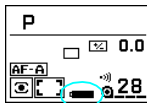

Full-battery indicator

Power is sufficient for all camera operations.

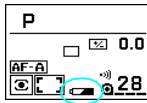

Half-battery indicator

Power is low, but all functions are operational. Keep a fresh battery handy.

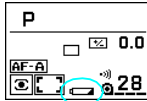

Low-battery indicator

Power is extremely low. The batteries will need to be replaced soon. Flash recycling time may be slow.

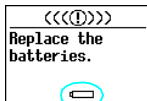

Batteries are exhausted

Power is insufficient for camera operation. Replace the batteries.

- If no display appears, power is too low for the camera to operate. Replace the batteries or make sure they have been inserted correctly.

LENS

Attaching the Lens

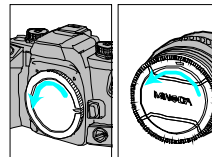

1. Remove the body and rear lens caps.

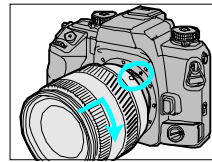

2. Align the red bead on the lens with the red dot on the camera's lens mount. Press the lens against the lens mount, and turn the lens clockwise until it clicks in the locked position.

- Do not press the lens release when mounting the lens. The lens will not couple properly.

Removing the Lens

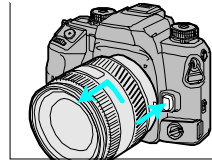

1. While pressing the lens release, turn the lens counter-clockwise until it stops.
2. Remove the lens and replace the caps, or attach another lens.

Caution

- Do not force the lens if it does not turn smoothly.
- Do not touch the inside of the camera, especially the lens contacts and mirror.

LOADING FILM

Remove and discard the protective cover on the film gate before loading film for the first time.

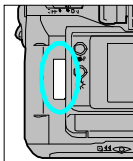

Check the film window before loading film. If film is already loaded, refer to Manual Rewind on page 34 to remove a partially exposed roll.

- Load film in the shade to reduce the chances of fogging the film.

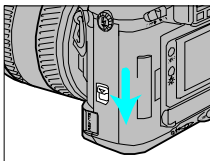

1. Slide the back-cover release and open the back cover.

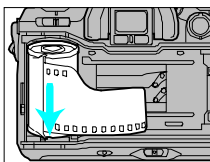

2. Insert film cartridge into the film chamber.

- Refer to page 159 to reload a partially exposed roll.

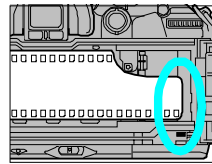

3. Extend the leader between the guide rails to the index mark.

- If the film tip extends beyond the index mark, push the excess film back into the cartridge.



4. Close the back cover.

- The camera automatically advances the film to the first frame. 1 will appear in the frame counter.

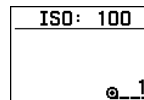

- The ISO is shown in the navigation display for 5 seconds after loading.

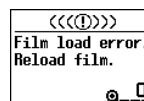

- If loading was unsuccessful, this message appears in the navigation display. Repeat steps 1-4.

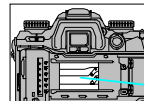

The shutter curtain's precision design makes it extremely sensitive to pressure. Never touch it with your fingers or the film tip.

shutter curtain

order manuals online at: realeasybay.com/manuals

LOADING FILM

- Once the film is loaded, the back cover will lock until film rewinding is complete, preventing accidental opening.
- ISO is set automatically if DX-coded film is loaded. See page 86 for changing ISO manually.
- Non-DX-coded film is automatically rewound at the end of the roll or after 36 exposures.
- Non-DX-coded film is set to the ISO from the previous roll. Refer to page 86 to set the film speed manually.
- Do not use Polaroid Instant 35mm film. Winding problems may occur.
- Do not use infrared film in this camera. The camera's frame counter sensor will fog infrared film.

HANDLING THE CAMERA

Holding the Camera



Grip the camera firmly with your right hand, while supporting the lens with your left. Keep your elbows at your side and your feet shoulder-width apart to hold the camera steady. Keep the camera strap around your neck or wrist in the event you accidentally drop the camera.

- Do not touch the end of the lens barrel while taking a picture.
- Do not block the AF illuminator.
- Use a tripod when using slow shutter speeds or a telephoto lens.
- When taking vertically aligned photographs, the use of the vertical control grip, allows for easy access to all camera functions.

Pressing the Shutter-Release Button

Press the shutter-release button partway down to activate the camera's autofocus and auto-exposure systems. Gently press the shutter-release button all the way down to take the picture.

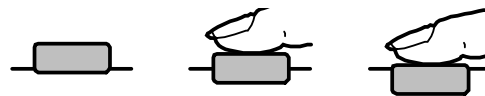

📷 TAKING PICTURES IN FULL-AUTO

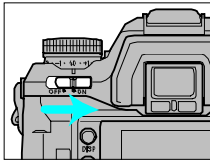

1. Turn the main switch to ON.

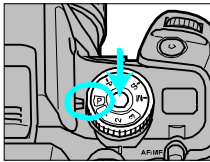

2. While pressing the exposure-mode dial lock-release button, set the exposure-mode dial to **P** full-auto.



Full-auto is shown in the display. When the upper part is black, as shown, the position of the dials and levers may not match the actual camera control.

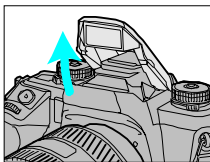

3. Raise the built-in flash.

- If the flash is raised, it will automatically fire when needed.
- For details on using the built-in flash, see page 31.

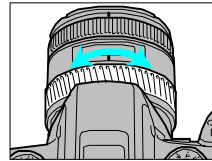

4. If using a zoom lens, rotate the zooming ring to frame your subject as desired.



5. Center your subject in the focus frame.



6. Press the shutter-release button partway down.

- Focus will be set automatically.
- Audio sounds and the local focus area LED appears briefly indicating the focus area selected by the camera.

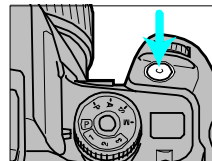

7. When **●** or **⦿** appears in the viewfinder, press the shutter-release button all the way down to take the picture.

- Use focus lock (p.29) if your subject is outside the focus frame.

TAKING PICTURES IN FULL-AUTO



The number of frames remaining is displayed in the viewfinder for the last 19 frames on the roll. This countdown does not appear for non-DX-coded film.

- You can not take more pictures on a roll than what is stated on the film cartridge.
- Audio sound can be canceled (p 131).

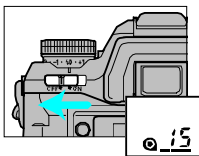

- After taking picture, turn the camera off.
- After the camera is turned off, the frame counter remains displayed in the top data panel, but not in the rear navigation display.
- The frame counter in the top data panel disappears when the main switch is turned on.

Full-Auto Basic Settings





When the exposure-mode dial is set to , the functions in the table below are reset to the full-auto mode, and locked in order not to be changed.

Function	Full-Auto Settings	Page No.
Exposure mode	Program (P)	61
Metering mode	14-segment honeycomb-pattern	74
Flash mode	Autoflash, if the built-in flash is up. (Pre-flash for red-eye reduction fires in accordance with the position of the flash-mode switch).	99
Focus mode	AF-A, Autofocus priority	46
AF area	Wide focus area	54
Drive mode	Single frame advance	87

26

Function	Full-Auto Settings	Page No.
Exposure compensation	+/- 0.0EV	77
Flash compensation	+/- 0.0EV	103
P/PPs creative program mode	Cleared	62
Flash-metering method	ADI (Advanced Distance Integration) 4-segment metering	108

BASIC OPERATION

- When the exposure-mode dial is set to , the functions in the table above are reset to full-auto mode, and locked in order not to be changed. However, if Custom 24-2 (p. 178) is selected, these settings can be changed after the dial is set to .
- The following items will not be reset when the exposure-mode dial is set to . Additional changes to these can be made after selecting .
 - Whether built-in flash fires or not
 - Red-eye reduction
 - Date and time imprinting
 - Data memory
 - Eye-start
 - ISO setting
 - Audio sound setting
 - Custom function settings, except for custom functions 1, 20, 21, 22 and 23.

27

FOCUSING

Focus Signals



The following signals appear in the viewfinder to indicate the focus status when the shutter-release button is pressed partway down.

- **Focus is confirmed.**
 - Continuous autofocus – **Focus is confirmed.**
 - Continuous autofocus – **Lens focusing.** Shutter is locked.
 - (Blinks) **Focus cannot be confirmed** – Shutter is locked.
 - Subject is too close or is one of the special focus situations described on page 30.
- In the above chart, the shutter is locked when the lens is focusing or when focus cannot be confirmed. To change so that the shutter can be released, even if focus has not been confirmed, select Custom1-2.
 - If eye-start is on, it is possible to activate focus by bringing the camera to your eye. See eye-start for more information (p. 125).

Focus Lock



Use focus lock when your subject is outside the focus frame or when autofocus is difficult to confirm.

- The focus lock method described on this page, is used for stationary subjects. For moving subjects, see page 47.

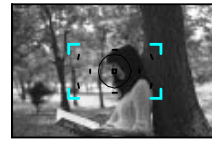

1. **Center your subject in the focus frame, then press the shutter-release button partway down.**

- ● appears in the viewfinder when focus is confirmed.
- Focus lock also locks the exposure settings when 14 segment honeycomb-pattern metering is selected (p. 74).

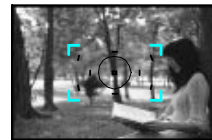

2. **Continue to hold the shutter-release button partway down while you compose your picture.**

3. **Press the shutter-release button the rest of the way down to take the picture.**

- If the shutter-release button is raised partway up, focus lock will not be cancelled. If you want the camera to refocus, remove your finger from the shutter-release button.
- Focus lock is not possible unless ● appears in the viewfinder.

FOCUSING

Special Focus Situations

The camera may not be able to focus in situations like those described below. When the focus signal blinks, use focus lock (p. 29) or manual focus (p. 48). See page 28 for an explanation of the focus signals.



If the subject within the focus frame is very bright, or low in contrast.



If two subjects at different distances overlap in the focus frame.

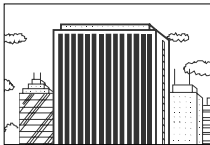

If a subject composed of alternating light and dark lines completely fills the focus frame.



If your subject is near a very bright object or area.

USING THE BUILT-IN FLASH

The built-in flash provides coverage for focal lengths as wide as 24mm.

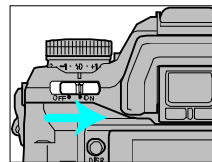

1. Turn the main switch to ON and set the exposure-mode dial to .

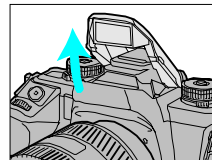

2. Raise the built-in flash.
3. Press the shutter-release button to take the picture.

- When the exposure mode dial is set to , the built-in flash will fire only when necessary.
- For red-eye reduction, turn the flash-mode switch to the red-eye reduction position.
- To cancel the flash, push the flash down.

Flash Signals



The following signals appear in the viewfinder to indicate the flash status when the shutter-release button is pressed partway down.



Flash is charged.



(Blinks) Previous exposure was correct.

USING THE BUILT-IN FLASH

Flash Range

The range of the built-in flash depends on the speed of the film and the selected aperture. Make sure your subject is within the flash range specified in the table below.

Aperture	ISO 100	ISO 200	ISO 400
f/2.8	1.0 ~ 4.3m (3.3 ~ 14.1 ft.)	1.0 ~ 6.1m (3.3 ~ 20.0 ft.)	1.0 ~ 8.6m (3.3 ~ 28.2 ft.)
f/3.5	1.0 ~ 3.4m (3.3 ~ 11.2 ft.)	1.0 ~ 4.8m (3.3 ~ 15.7 ft.)	1.0 ~ 6.8m (3.3 ~ 22.3 ft.)
f/4	1.0 ~ 3.0m (3.3 ~ 9.8 ft.)	1.0 ~ 4.2m (3.3 ~ 13.8 ft.)	1.0 ~ 6.0m (3.3 ~ 19.7 ft.)
f/5.6	1.0 ~ 2.1m (3.3 ~ 6.9 ft.)	1.0 ~ 3.0m (3.3 ~ 9.8 ft.)	1.0 ~ 4.3m (3.3 ~ 14.1 ft.)

Lens Shadowing

Lens shadowing occurs when the lens or lens hood blocks part of the output from the built-in flash. Lens shadowing appears as semi-circular shaded area at the bottom (horizontal) or side (vertical) of your image.

- Make sure you are at least 1m (3.3 ft.) from your subject when using the built-in flash.
- Remove the lens hood before using the built-in flash.
- Lens shadowing may occur with the following lenses at shorter focal lengths.

AF Zoom 17-35mm f/3.5G	AF Zoom 28-70mm f/2.8G
AF Zoom 28-85mm f/3.5-4.5	AF Zoom 28-135mm f/4-4.5
- The built-in flash can not be used with the following lenses:

AF 300mm f/2.8 (APO tele)	AF 600mm f/4 (APO tele)
AF 300mm f/4 (APO tele)	

REWINDING THE FILM

Automatic Rewind

The film is automatically rewound after the last frame is exposed.

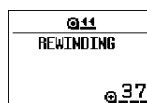

1. Wait until the film is completely rewound.

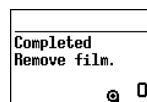

- Do not open the back cover until this message appears in the navigation display. Never use force.

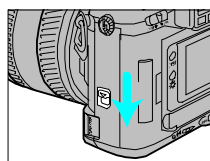

2. When the film is completely rewound, open the back cover and remove the film.

- If the manual rewind button is pressed while the film is rewinding, the rewind speed will change.

order manuals online at: realeasybay.com/manuals

REWINDING THE FILM

Manual Rewind

Use manual rewind to rewind the film before the roll is finished.

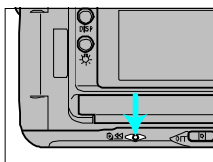

Gently press the manual-rewind button.

- Use a blunt object. A sharp object may cause damage.

Custom Function Notes

Custom 2, 3 and 12 refer to the rewinding of film.

Custom 2 - Automatic (1) or manually initiated (2) rewind start.

Custom 3 - Rewind the leader into the cartridge (1) or leave the leader out (2).

Custom 12 - Fast (1) or slow/silent (2) rewind.

DETAILED OPERATION

Once you have mastered the basic operation, you can move on to the Detailed Operation section to expand your expertise. Read those pages pertaining to the areas of your interest and need.

DETAILED OPERATION

Navigation Display	36
Focusing.....	45
Exposure	60
Metering	73
Drive.....	87
Flash.....	98
Additional Features.....	119
Memory Functions.....	132
Data Memory.....	140
Custom Functions	153

NAVIGATION DISPLAY

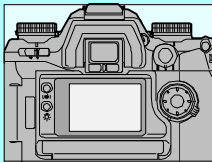

Your camera uses the navigation display (a dot-matrix presentation in the large LCD panel on the back of the camera) to provide you with useful photographic information.

- Only general information is included in this section. Please refer to each specific section for more detailed information.
- Display will be slow in cold weather, but it normalizes when it warms up.
- If the camera is not operated for more than 1 hour, with the main switch on, the display will disappear. Press the shutter-release button partway down, or turn the main switch off and then back on, for the display to re-appear.

DISPLAY SELECTION

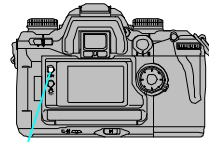

Display-selection button

When the camera is first turned on, the detailed display is shown. Pressing the display-selection button causes the displays to change as follows:

Detailed display
↓
Large icon display
↓
Meter-index display
↓
Exposure-history display

- The horizontal detailed display is used for explanations throughout this manual.

DISPLAY SELECTION

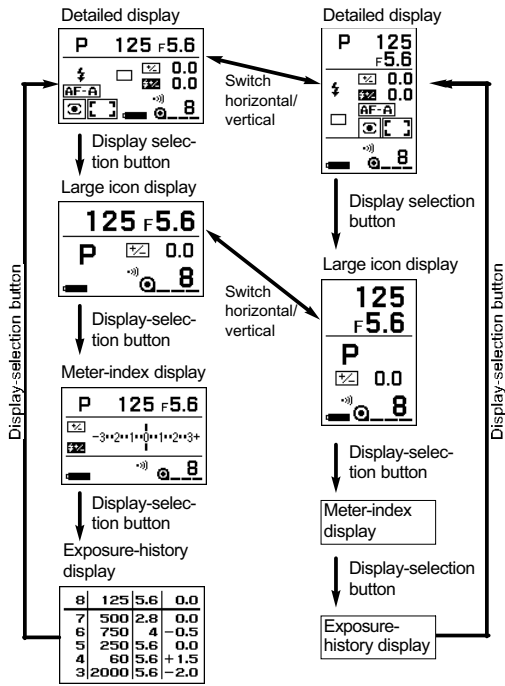

38

Detailed Display

The detailed display shows all the settings.

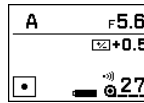

• By selecting Custom 27-2 (p. 182), you can show only those settings which differ from the standard settings.

Large Icon Display

For easier viewing of only a few items, select the large-icon display option.

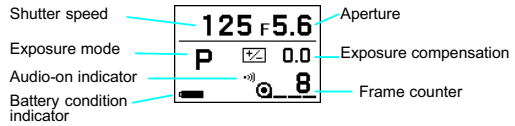

• To cancel this display, select Custom 29-2 (p. 184).

NAVIGATION DISPLAY

39

DISPLAY SELECTION

Meter-Index Display

The meter index display shows the values of compensation and bracketing that you have selected. The lower part shows compensation/bracketing with flash. The upper part of the display is shown in both the viewfinder and the navigation display.

Current exposure information

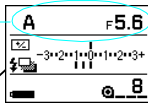

The metering index display contains the following:

- Exposure compensation (p. 77)
- Flash compensation (p. 103)
- Metered manual value (p. 71)
- Exposure bracketing (p. 92)
- Flash bracketing (p. 104)
- When AEL appears, EV difference between the AE locked and current exposure value. (p. 83)

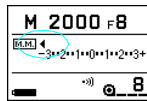

• ◀ or ▶ appears if the index is more than +/- 3.0 EV.

• To cancel this display, select Custom 30-2 (p. 185).

Exposure-History Display

The exposure data for the next frame appears in the top of the display, followed by the those of the last 5 frames.

Top left part usually shows frame counter, but changes when multiple exposure drive mode or STF is selected:

- M1, M2 ...: When in multiple-exposure mode.
- STF: When in STF mode.

Shutter speed
Aperture
Exposure compensation

8	125	5.6	0.0
7	500	2.8	0.0
6	750	4	-0.5
5	250	5.6	0.0
4	60	5.6	+1.5
3	2000	5.6	-2.0

- Displays present frame count.
- If there is no film in the camera, there will be no display.

- In this display, the imprint indicator , data memory ON indicator and the audio indicator will not appear.
- After 5 exposures, whenever the shutter is released, the oldest exposure data is deleted.
- For multiple exposures, the history shows the data of every exposure.
- Exposure-history is cleared by the replacement of the battery.
- To cancel this display, select Custom 31-2 (p. 185).

DISPLAY SELECTION

Vertical Display

The horizontal/vertical operation automatically changes the orientation of the navigation display, when the camera's position is changed to a vertical or horizontal position.

- Only the detailed and large-icon display are able to be displayed vertically. All others remain in the horizontal orientation.
- If you want the display to remain in the horizontal orientation, regardless of the camera's position, choose Custom 32-2 (p. 186).

Operation Display

The operation display appears whenever you operate a camera dial or function that is not currently on the display. The new settings will appear for 5 seconds. When the detailed display has been selected, the operation display will not appear.

Example below shows the large icon display. When continuous (high-speed) drive mode is selected, the display changes to the operation display showing the new change, and then returns to the large icon display 5 seconds later.

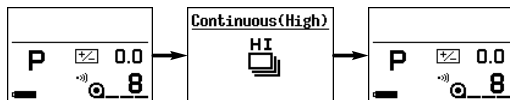

- During the display's 5 second period, pressing the shutter-release button partway down will return the display to the previous display.
- To cancel this display, select Custom 28-2 (p. 184).

DISPLAY (WHEN UPPER PART TURNS BLACK)

When the exposure-mode dial is turned to P, A, S, or M, the upper part of the display remains normal. But when , 1, 2, or 3 is selected, the upper part turns black.

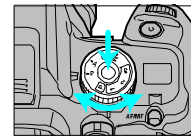

When the dial is set to full-auto or to one of the memory settings, the upper part of the display turns black and the position of the dials and levers may not match the actual camera control. The camera recalls the full-auto settings or the settings saved in the selected memory function, and these are correctly shown on the navigation display.



Example 1: Exposure-mode dial set to P. (Normal)



Example 2: Exposure-mode dial set to , full-auto mode. Top part of display has turned black.

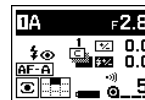

Example 3: Exposure-mode dial set to 1. (memory setting). Top part of display has turned black.

DISPLAY BRIGHTNESS AND CONTRAST

Display Illumination

If desired, the display can be illuminated.

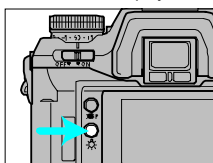

Press the navigation display illuminator.

- The display illuminator shuts off approximately 5 seconds after the last camera operation.
- If the button is pressed again before the 5 seconds, it will shut off.

Display Contrast

The contrast level of the display is adjustable.

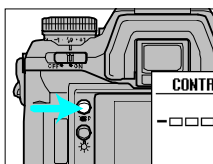

1. Press the display selection button for 3 seconds to select the contrast set display.

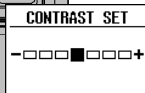

- The contrast set display appears.

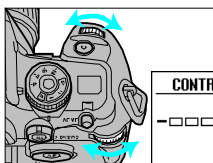

2. Turn either the front or rear-control dial to adjust the contrast intensity.

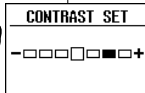

- Turning the dial in the + direction increases the intensity.

• The contrast display will disappear when the shutter-release button is pressed partway down.

FOCUSING

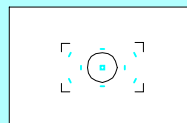

Your camera features complete focus control, utilizing a newly developed 9-point autofocus system with center dual cross-hair sensors to give great flexibility when composing photographs, and the ability to switch between AF and MF using the AF/MF control button without changing holding positions.

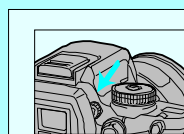

The location of the film plane is indicated by the arrow.

FOCUS MODE

Your camera has 3 autofocus modes plus manual focus. With the camera set to other than **P**, you can select one of the following modes.

- Automatic autofocus (A)
- Continuous autofocus (C)
- Single-shot autofocus (S)
- Manual focus (MF)

Automatic Autofocus (A)

Designed to work well in almost any situation, automatic autofocus is especially suited to moving subjects that stop suddenly. When the subject is moving, continuous autofocus is set. When not moving, single-shot autofocus is set.

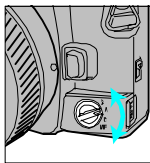

1. Turn the focus-mode switch to **A**.
2. Press the shutter-release button partway down to activate autofocus.

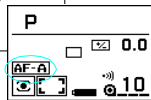

- The camera will continue to focus as long as the subject is moving, then lock focus when the subject is still.
- **AF-A** appears in the display.

- When the exposure-mode dial is set to **P**, automatic autofocus is set.
- Using custom functions, you can choose to select direct manual focus (DMF) when the focus-mode switch is in the A position (p. 176).

Continuous Autofocus (C)

Use continuous autofocus when shooting sporting events or when you know the subject will be in constant motion.

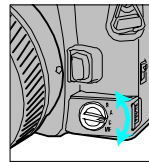

1. Turn focus-mode switch to **C**.
2. Press the shutter-release button partway down to activate autofocus.

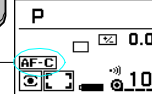

- **AF-C** appears in the display.

- The camera continues to focus as long as the shutter-release button is pressed partway down.
- Audio doesn't sound and the local focus area LED doesn't appear in the viewfinder in this mode.

Single-Shot Autofocus (S)

Use single-shot AF when photographing non-moving subjects or to lock focus on subjects outside the focus area.



FOCUS MODE

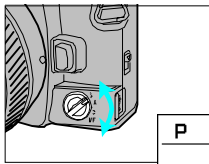

1. Turn the focus-mode switch to **S**.
2. Press the shutter-release button partway down to activate autofocus.

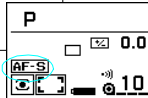

- **AF-S** appears in the display.

- Once confirmed, focus remains locked until your finger is removed from the shutter-release button.

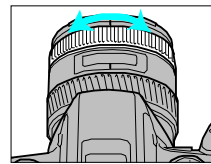

2. Turn the focusing ring until your subject appears sharp and focused.

- **AF** appears in the viewfinder when the subject in the focus frame is in focus.
- Even though manual focus has been selected, it is possible to utilize autofocus by pressing the AF/MF control button (p. 51).
- When the focus ring doesn't turn smoothly (for example when using a teleconverter) see page 52.
- This camera uses distance information, even when in manual focus mode, to obtain a proper exposure. In order to get precise information, the focus position is at infinity when the camera's main switch is moved to the ON position.

Manual Focus (MF)

Focus the lens manually when autofocus is not suitable and focus lock is not possible. The autofocus system will monitor focus and indicate when a subject in the focus frame is in focus.

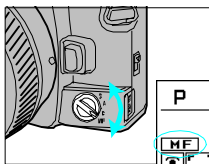

1. Turn the focus-mode switch to **MF**.

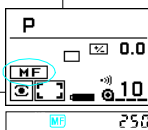

- **MF** is displayed in both the viewfinder and navigation display.

AF Power Zoom and xi Series Lenses

Pull and turn the zoom ring until your subject appears sharp.

order manuals online at: realeasybay.com/manuals

AF/MF CONTROL BUTTON

The AF/MF control button is located on the back allowing an instant selection of focus mode with the right thumb without changing the holding position.

- AF/MF control button cannot be used with xi series and AF Power zoom lenses.

AF to MF

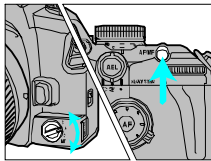

In AF mode (focus-mode switch set to C, A, or S), the AF mode is switched to MF mode while pressing the AF/MF control button.

- Turn the focusing ring while pressing the AF/MF control button.

- **MF** will appear in the viewfinder while the AF/MF control button is pressed. However, the AF-mode indicator in the navigation display (AF-A, AF-C, AF-S) doesn't change.
- If you don't change the focus, the focus will remain locked while pressing the AF/MF control button.
- If Custom 9-2 is selected, autofocus and manual focus are automatically switched over by every push of the AF/MF control button, instead of while pressing the AF/MF control button (p. 167).

MF to AF

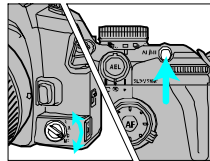

In MF mode (focus-mode switch set to MF), when the AF/MF control button is pressed, the MF mode is switched to AF-S, autofocus is activated, and then focus is locked.

- When you release the AF/MF control button, the camera returns to MF mode, and now re-focusing is possible using the focusing ring.
- When the AF/MF control button is pressed, the camera will also meter the subject.
- While pressing the AF/MF control button, **MF** disappears in the viewfinder, but will remain in the navigation display.
- If Custom 9-2 is selected, autofocus and manual focus are automatically switched over by every push of the AF/MF control button, instead of while pressing the AF/MF control button (p. 167).

FOCUS AREA

Smooth Focusing

The advance total focus control system has many advantages over the conventional system. However, when used with certain lenses, such as a teleconverter, the lens may have a heavier feel than conventional models, when focusing manually. If desired, users can temporarily select a conventional manual focus operation.

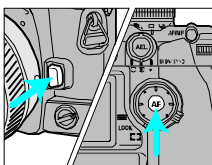

1. Set the focus-mode switch to MF.
2. Simultaneously press the spot-AF button and lens release.
3. Release your finger from the lens release first, then from the spot-AF button.

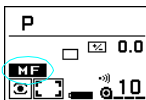

- MF appears instead of the normal AF.

- The AF/MF control button is inactive when the reversed MF appears on the navigation display.
- Some benefits, such as improved exposure metering and flash-metering accuracy in manual focus, will now be the same as with a conventional camera.
- 14-segment honeycomb-pattern (p. 74) is changed to metering similar to center-weighted average when this option is selected.
- To return to the usual camera operation, set the focus-mode switch to C, A, or S, or set the exposure-mode dial to full-auto.
- AF Power zoom and xi Series lenses cannot be used.

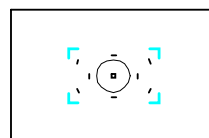

Wide focus area

The camera's standard focus mode, wide focus area, covers the entire center area making it easier for the camera to focus on moving subjects. Nine sensors are located in the wide focus area, which are shown by the local focus area in the viewfinder. When you press the shutter-release button partway down, the camera automatically decides which sensor to be used, and the corresponding local focus area LED lights in the viewfinder.

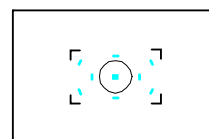

Local focus area

The local focus area mode also utilizes 9 point sensors, resulting in greater flexibility when photographing still objects. When you select any of these local focus areas, the corresponding sensor is shown in the viewfinder.

- When continuous autofocus (C) or automatic AF (A) with continuous focus is selected, the local-focus area LED will not be illuminated in the viewfinder.
- The display time of the local focus area can be selected by using Custom 14 (p. 170).

FOCUS AREA

Choose the wide or local focus area as desired. By simply pressing the spot-AF button, the center spot-focus area is selected.

Wide Focus Area

The camera automatically decides which sensor to be used.

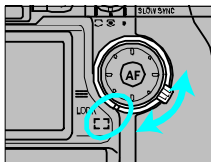
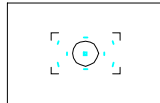

1. Set the wide/local focus-area switch to wide.

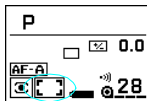

• Wide focus area appears in the display.

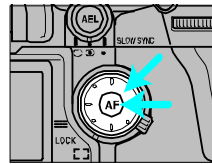

2. Press the focus-area selector to focus using the wide focus area. Press the spot-AF button to use the center spot-focus area.



- Viewfinder shows which sensor is being used for focusing.
- While pressing the spot-AF button or the focus-area selector, the focus is locked.

3. While pressing either the focus-area selector or the spot-AF button, press the shutter-release button and take the picture.

- When the exposure-mode dial is set to **P**, wide focus area is set.
- After taking the picture, as long as the spot-AF button or the focus-area selector remains pressed, focus remains locked, and additional pictures may be taken.
- If 14-segment honeycomb-pattern is selected, the exposure is locked when the focus is locked.
- When **P** is selected, autofocus is not activated by pressing the focus-area selector or the spot-AF button.

FOCUS AREA

Local Focus Area

Any one of the 9 local focus areas can be selected.

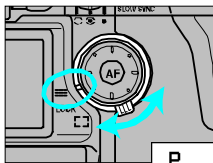
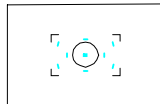

1. Set the wide/local focus-area switch to local.

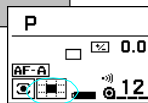

• The local focus-area appears in the navigation display.

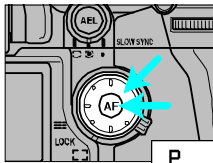

2. Press the focus-area selector to select the local focus area you want. Press the spot-AF button to use the center spot-focus area.

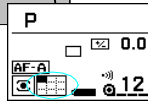

- Viewfinder shows which sensor is being used for focusing.
- While pressing the spot-AF button or the focus-area selector, the focus is locked.

3. While pressing either the focus-area selector or the spot-AF button, press the shutter-release button and take the picture.

- After taking the picture, as long as the spot-AF button or the focus-area selector remains pressed, focus remains locked, and additional pictures may be taken.
- If you release your finger from the focus-area selector or the spot-AF button, locked focus (position) is canceled, but local focus area remains.
- If 14-segment honeycomb-pattern is selected, the exposure is locked when the focus is locked.
- The same local focus area can be used to adjust focus (see p. 58).
- Only the center spot-focus area can be used with the AF Reflex 500mm f/8 lens and AF Power zoom 35-80mm, f/4-5.6.

FOCUS AREA

How to Lock the Local/Spot Focus Area

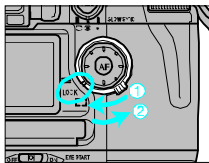

1. Turn the wide/local focus area switch to local, and select the focus area you want to lock.
2. Turn the wide/local focus-area switch to lock.

How to Lock the Wide Focus Area

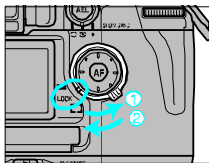

1. Turn the wide/local focus area switch to wide.
2. Turn the wide/local focus-area switch to lock.

- After taking the picture, the focus area remains locked.
- When the wide/local focus-area switch is locked, pressing the focus-area selector or the spot-AF button doesn't activate the focus.

AF ILLUMINATOR

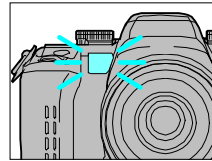

In low-light/low subject contrast situations, the AF illuminator automatically projects a pattern of lines onto the subject for the camera's AF sensors to focus on.

- Do not obstruct the AF illuminator.
- AF illuminator works for the center focus area only.
- The range of the AF illuminator is 0.7 – 7.0 meters (2.3 – 23.0 ft.).
- The AF illuminator will not fire in continuous autofocus mode.
- The AF illuminator may not operate with 300mm or longer single focal length lenses.
- The AF illuminator will not operate with 3x-1x Macro Zoom.
- When an accessory flash is attached, its AF illuminator may be active in place of the camera's AF illuminator.
- AF illuminator can be canceled by Custom 21-2 (p. 176).

EXPOSURE

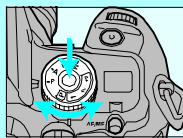

Your camera's exposure-mode dial has 8 positions:

- Full-auto
- P, A, S, and M modes
- 1, 2, and 3 memory modes

This section of the manual covers the P, A, S, and M modes.

- For the **P** full-auto mode, see pages 24-27.
- For memory modes, see page 132.

P MODE

Select P mode (Programmed AE) when you want to give your full attention to your subject and composition. The P mode software analyzes the subject's size, motion, and magnification as well as the focal length of your lens, then sets the shutter speed and aperture according to the requirements of the scene.

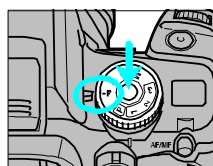

- While pressing the exposure-mode dial lock-release button, turn the exposure-mode dial to P.
- Compose your scene, focus, and take the picture.



- When the shutter-release button is pressed partway down, metering occurs and the shutter speed and aperture are shown on the navigation, top data panel, and viewfinder displays.

Comparison of **P** (full-auto) mode to P (program) mode:

In the **P** (full-auto mode), all the camera settings are set automatically.

In the P (program mode), the camera sets the shutter-speed and aperture, but all other camera settings are changeable.

P MODE

P-Mode Flash

When the built-in flash is up or an attached accessory flash is on, it will fire each time the shutter is released. The camera's automatic flash metering system will ensure proper exposure.

- Make sure your subject is within the flash range (p. 32).

PA/Ps Mode

After the AE system has been activated, you can change the shutter speed or aperture selected by the camera. Creative program remains active until the display disappears.

While the aperture/shutter speed are displayed in P mode...

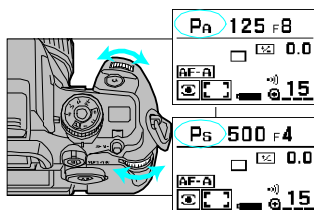

Turn the front control dial to change the shutter speed.

- Aperture is adjusted automatically.

Turn the rear control dial to change the aperture.

- Shutter speed is adjusted automatically.

- The aperture and shutter speed change in 1/2 or 1/3 EV increments depending on the position of the exposure compensation dial.
- Flash can not be used with the PA and Ps modes.
 - Built-in and accessory flashes will not fire when the PA and Ps modes are active.
 - PA and Ps modes can not be selected when the built-in flash is up or the accessory flash is on.
- To cancel PA / Ps mode, press the exposure-mode dial lock-release button. It will also be cancelled 5 seconds after the display disappears, or immediately when the built-in flash is raised.

A MODE

In A mode (aperture priority), you select the aperture and the camera automatically sets the shutter speed required for proper exposure. Set the camera to A mode when you want to control the range of focus (depth-of-field) in an image.

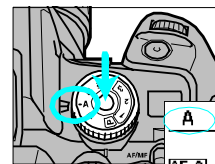

1. While pressing the exposure-mode dial lock-release button, turn the exposure-mode dial to A.

- A appears in the navigation display.

- ▶ appears in the viewfinder, next to the aperture display, indicating that the aperture can be changed.

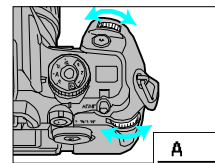

2. Turn either control dial to select the aperture.

- The aperture setting changes in 1/2 or 1/3 EV increments depending on the position of the exposure compensation dial. See page 77.

A MODE

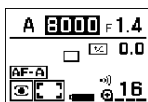

• When pressing the shutter-release button part-way down, if 8000 or 30" blinks or the printing reverses, the required setting is beyond the camera's shutter speed range. Turn the control dial until the blinking/reversing stops.

A-Mode Flash

1. Follow the steps on the previous page.
2. Raise the built-in flash, or turn the accessory flash on.
 -  appears in the viewfinder when the flash is charged.
 - The shutter speed is automatically set to 1/200 or slower.
 - When the built-in flash is up or an attached accessory flash is on, it will fire each time the shutter is released. The camera's automatic flash metering system will ensure proper exposure.
 - The use of a large aperture is recommended for a longer flash range.

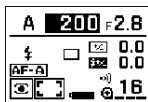

• When pressing the shutter-release button part-way down, if 200 blinks or the printing reverses, the required setting is beyond the camera's shutter speed range. Turn the control dial until the blinking/reversing stops.

Aperture Control



Large Aperture
(small f-number)



Small Aperture
(large f-number)

The size of the aperture (lens opening) determines the depth-of-field in the final image as well as the intensity of the light falling on the film. Depth-of-field is the area in front of and behind the point where the lens is focused which will appear sharp.

Large apertures (small f-numbers) limit the depth-of-field to a narrow range. Choose a large aperture if you want a defocused background so your main subject stands out, such as with portraits.

Small apertures (large f-numbers) provide greater depth-of-field. Choose a small aperture when you want maximum focus range, such as in a landscape photograph.

- In general, wider lenses provide more depth-of-field and longer (telephoto) provide less depth-of-field.
- There is less depth-of-field when your subject is close to the lens.

S MODE

In S mode (shutter priority), you select the shutter speed and the camera automatically sets the aperture for the proper exposure. Use S mode when you want to control the blur caused by subject movement.

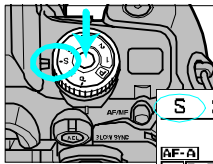

1. While pressing the exposure-mode dial lock-release button, turn the exposure-mode dial to S.

- S appears in the navigation display.
-  appears in the viewfinder, next to the shutter speed, indicating that the shutter-speed can be changed.

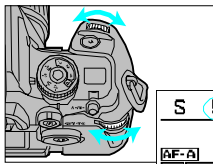
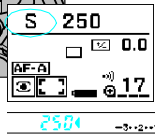

2. Turn either control dial to select the shutter speed.

- The aperture setting changes in 1/2 or 1/3 EV increments depending on the position of the exposure compensation dial. See page 77.

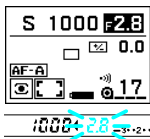
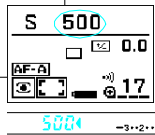

- When pressing the shutter-release button part-way down, if the aperture value blinks or the printing reverses, the required setting is beyond the camera's aperture range. Turn the control dial until the blinking/reversing stops.

- BULB (Time exposure) should be used when in the M mode.

S-Mode Flash

1. Follow the steps on the previous page.
2. Raise the built-in flash, or turn the accessory flash on.

-  appears in the viewfinder when the flash is charged.
- Shutter speeds of 1/200 or slower can be selected. However, shutter speeds greater than 1/200 can be achieved using high speed sync 5600HS(D), 3600HS(D), or 5400HS (p. 110).
- When the built-in flash is up or an attached accessory flash is on, it will fire each time the shutter is released. The camera's automatic flash metering system will ensure proper exposure.

S MODE

Shutter Control



Fast Shutter Speed



Slow Shutter Speed

Because the shutter speed controls the duration of exposures, it also determines how moving subjects will appear in the final image. Use a slow shutter speed to blur the motion of your subject. Use a fast shutter speed to stop the motion of your subject. In addition to stopping action, fast shutter speeds can help prevent blur caused by camera movement during the exposure.

M MODE

M mode (Manual) gives you full control of the exposure. The camera's meter index displays how your settings compare to the exposure determined by the camera's metering system.

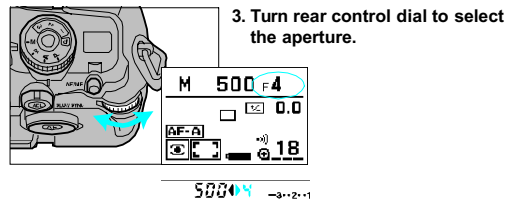
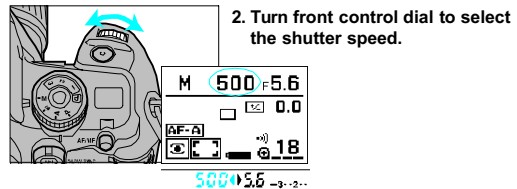
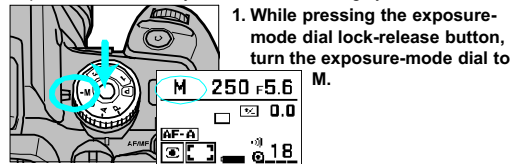

M MODE

- ◀ ▶ appears in the viewfinder, next to the shutter-speed and aperture display, indicating that both can be changed.
- The aperture setting changes in 1/2 or 1/3 EV increments depending on the position of the exposure compensation dial.

M-Mode Flash

1. Follow the steps on the previous page.
2. Raise the built-in flash, or turn the accessory flash on.
 -  appears in the viewfinder when the flash is charged.
 - The shutter speeds of 1/200 or slower are selectable. However, shutter speeds greater than 1/200 can be achieved using high speed sync flash 5600HS(D), 3600HS(D), or 5400HS (p. 110).
 - When the built-in flash is up or an attached accessory flash is on, it will fire each time the shutter is released. The camera's automatic flash metering system will ensure proper exposure.

Metering in M Mode

The meter index displays the EV difference between your settings and the 'correct' exposure determined by the camera. The 0 position (null point) represents the recommended exposure using the currently selected metering pattern (pp.82-83). (Metered manual).

◀-3•2•1•0•1•2•3▶
Your settings match the recommended exposure.

◀-3•2•1•0•1•2•3▶
Your settings will underexpose the metered area by 1.5EV.

◀-3•2•1•0•1•2•3▶
Your settings will overexpose the metered area by 1EV.

◀-3•2•1•0•1•2•3▶
Your settings will overexpose the metered area by 1.3EV.

- The EV scale is marked in 1/2 or 1/3 EV increments depending on the current setting of the exposure compensation dial (p. 77).

- ◀ or ▶ will blink in the meter index if the settings will over or underexpose the subject by more than 3.0 EV.

◀-3•2•1•0•1•2•3▶

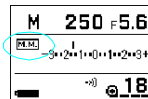

- If you press the display-selection button, the meter-index display appears in the navigation display. Index in M mode (Metered manual) is shown in the upper mid- area with M.M..

order manuals online at: realeasybay.com/manuals

M MODE

Manual Shift

Manual shift lets you shift to equivalent aperture/shutter speed combinations without changing the exposure value (EV).

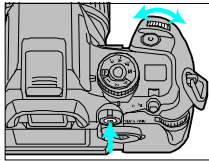

1. Select a desired shutter speed and aperture.
2. Press the AE-lock button and turn the front control dial until the desired aperture/shutter speed combination appears in the display.

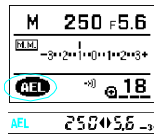

• While pressing the AE-lock button, AEL appears in the viewfinder and **AEL** appears in the navigation display.

- The operation of the AE-lock button can be changed by custom function 10 (p. 168).
- When you select the 1/3 EV increments setting, the locked exposure may change if the maximum aperture of 1/2 EV increments is chosen.

METERING

SELECTABLE METERING

Your camera takes meter readings of the light in the scene to determine the correct exposure. It has three methods of taking meter readings. Use the method most appropriate for your subject.

14-Segment Honeycomb-Pattern Metering

Fourteen-segment honeycomb-pattern metering uses information from the autofocus system to set the metering pattern according to the position of the main subject. The light metered by each applicable segment is then evaluated to determine the degree of spot-lighting or backlighting present in your scene. The local focus-area (LED) momentarily displays the sensor being used when the shutter release button is pressed partway down.

Fourteen-segment honeycomb-pattern metering is the camera's standard metering mode and is appropriate for most photographic situations.

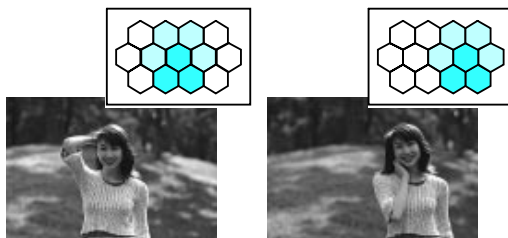

Centered subject

Subject on the right

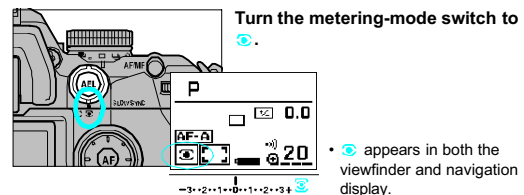

Spot Metering

Spot metering uses only the center honeycomb segment to meter the image. The center honeycomb segment is shown by the spot metering area in the viewfinder.

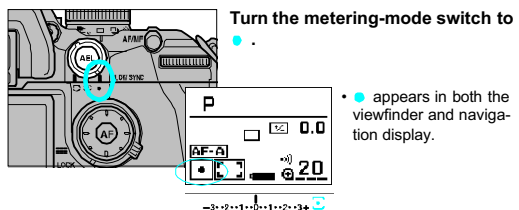
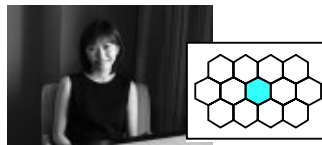



SELECTABLE METERING

Center-Weighted Average Metering

Center-weighted average mode bases the exposure on an average of the readings from each of the honeycomb segments - with emphasis placed on the center of the image.

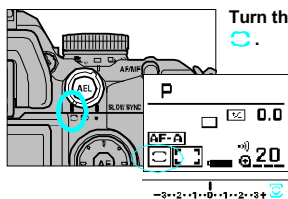
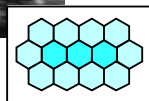
Care should be taken when photographing backlit, spotlighted, or off-center subjects, as non-subject areas may be included in the exposure calculation.



Turn the metering-mode switch to .

-  appears in both the viewfinder and navigation display.

EXPOSURE COMPENSATION



Under exposure



Proper exposure



Over exposure

Especially helpful when using the spot or center weighted metering patterns, exposure compensation lets you manually adjust the metered exposure ± 3 EVs in $1/2$ or ± 2 EVs in $1/3$ EV increments. This function is especially useful when shooting with slide film, because of the film's low tolerance for exposure error.

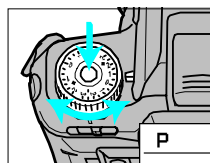

While pressing the exposure-compensation dial lock-release button, turn the exposure-compensation dial to the desired compensation value.



- Selected compensation value appears in the navigation display.

- Dial is locked only when you go from the 0.0 compensation setting.
- Select Custom 18 (p. 173) to change the exposure compensation value using the rear control dial in P, A, and S modes.

EXPOSURE COMPENSATION

Changing to 1/3 Increments

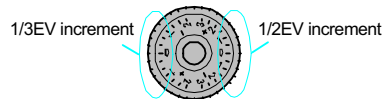

Example below shows changing from 1/2EV to 1/3EV increment.

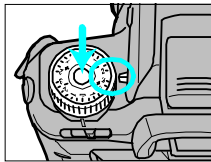

1. Set the exposure-compensation dial to the edge of the 1/2EV increment (ie; +/-3.0EV).
2. While pressing the exposure-compensation dial lock-release button, turn the exposure-compensation dial to the edge of the 1/3EV increment (ie; +/- 2.0EV).

- When going from 1/3EV increment to 1/2EV increment, use the same procedure as described in steps 1 and 2 above.
- If you select 1/3EV increment, aperture, shutter speed, and the value on the meter index will change to 1/3EV increment.
- If 1/3EV increments are selected, the lens' maximum/minimum aperture may not appear correctly, but the camera will be set correctly.

Meter Index

The meter index displays the exposure compensation value you set.

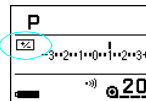
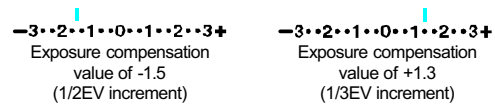

- If you press the display-selection button, the meter-index display appears in the navigation display. Exposure compensation index is shown in the upper mid-area with .

EXPOSURE COMPENSATION

Comparison between exposure compensation and flash compensation.

1. For exposure compensation, when the flash doesn't fire, the picture will be compensated by changes in both the shutter speed and the aperture.

2. For exposure compensation, when the flash does fire, compensation will be due to changes in shutter speed, aperture, and the flash burst.

3. For flash compensation, only the flash burst changes.

- Specifically for 1 and 2 above, when in;
 - P-mode - both shutter speed and aperture change.
 - A-mode - only the shutter speed changes.
 - S-mode - only the aperture changes.
- See page 103 for additional information regarding flash compensation.
- If you desire a fixed flash burst for exposure compensation with flash, select Custom 26-2 (p. 181).

AUTOMATIC EXPOSURE LOCK (AEL)

Press the AE-lock button to lock the exposure using the currently selected metering pattern without locking the focus. The exposure remains locked until the AE-lock button is released.



1. Select the desired metering pattern (pp. 74-76), and focus on subject.

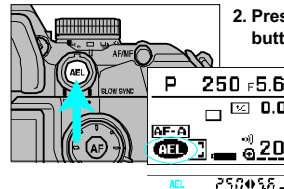

2. Press and hold the AE-lock button.

- **AEL** appears in the viewfinder and navigation display.

- Meter index also appears in the viewfinder (p. 83).



3. While pressing the AE-lock button, recompose the scene as desired.
4. While still pressing the AE-lock button, press the shutter-release button all-the-way down to take the picture.

AUTOMATIC EXPOSURE LOCK (AEL)

- If you keep pressing the AE-lock button after taking the picture, the exposure remains locked.
- Pressing the AE-lock button sets the flash to slow-shutter sync mode (p. 102).
- If Custom 10-2 is selected, pressing the AE-lock button once activates automatic exposure lock. Pressing again cancels.

Meter Index When AE-Lock Button is Pressed

The meter index displays the EV difference between the locked exposure and the exposure for the subject area currently inside the spot-metering area. Using the AE-lock button function, you can compare the difference between the locked (actual) exposure and the exposure in each part of the image. If the difference is more than +2.3EV, that part of the picture will be washed out. If the difference is more than -2.7EV, the picture will be dark and the details will be gone. Depending on the type of film, these values may change. Without taking the picture, you can measure the brightness and predict the results.

Example: Recompose the picture from ① to ②, while pressing the AE-lock button.

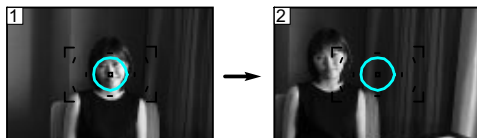

82

14-Segment Honeycomb-Pattern and Center-Weighted Average Metering

Press AE-lock button ①. → Keep pressing AE-lock button while recomposing picture ②.

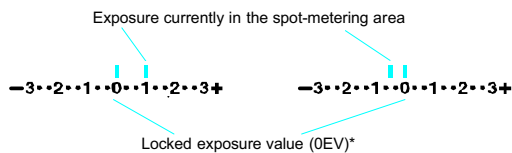

*Locked exposure will always be 0EV unless exposure compensation is set.

Spot Metering

Press AE-lock button ①. → Keep pressing AE-lock button while recomposing picture ②.

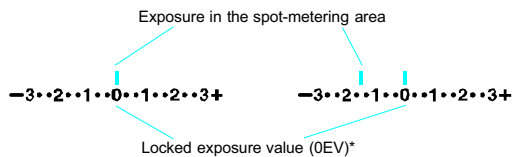

METERING

83

AUTOMATIC EXPOSURE LOCK (AEL)

- The EV scale is marked in 1/2 or 1/3EV increments depending on the current setting of the exposure compensation dial (p. 77).
- ◀ or ▶ will blink in the meter index if the settings will over or underexpose the subject by more than 3.0EV.

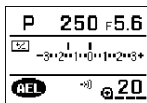

- If you press the display-selection button, the meter-index display appears in the navigation display. When you press the AE-lock button, the index shows the differences between the locked exposure and the exposure currently in the spot-metering area.

Brightness-Distribution Display

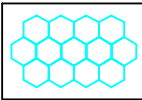

The display shows the difference between the locked value "0" and the output from each of the 14-honeycomb segments.

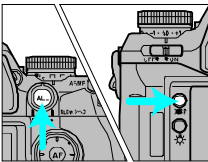

While pressing the AE-lock button, press the display-selection button. Each segment will be shaded and a value indicated.

- The shading appears as;
 - White : +1EV or more.
 - Gray : when between -1EV and +1EV. (No value given when gray)
 - Black : -1EV or less.

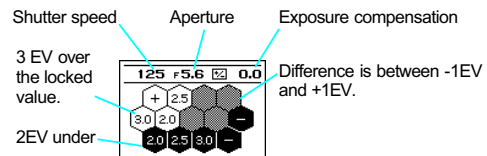

- If more than 3.0EV, only + or - will appear, instead of a value.
- Press the display-selection button once again to cancel the brightness-distribution display while still pressing the AE-lock button.
- If you release your finger from the AE-lock button, both brightness distribution and locked exposure will be canceled.
- Shutter speed, aperture, and exposure compensation appear in the top portion of the display.
- If a non-displayed setting is changed, the operation display appears.
- This feature is useful for monitoring which areas of the picture are under or over-exposed, and allows the user to also confirm the variation on the brightness distribution with the exposure-compensation dial.
- If bracketing is selected, the normal position (+/- 0) of the bracketing series will be displayed in the brightness-distribution display.
- Brightness-distribution display shows values without flash. When flash fires, displayed values may be slightly lower than the values without flash.
- The EV scale is marked in 1/2 or 1/3EV increments depending on the current setting of the exposure compensation dial (p. 77-78).

SETTING THE ISO MANUALLY

Set the ISO manually to override the DX-coded ISO or when using non-DX coded film.

- Film must be loaded before the ISO can be changed.
- Non-DX coded film is initially set to the previous roll's ISO.

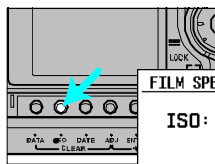

1. Open the control-panel door and press the ISO button.

- The current ISO is shown in the display.

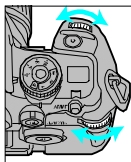

2. Turn either control dial to set the desired ISO value.

- The ISO can be changed manually from 6 to 6400 in 1/3 EV increments.

3. Press the shutter-release button partway down to enter the new ISO.

Custom 4-2 DX Memory ON (p. 164).
Applies ISO changes to future rolls with the same DX-coded ISO.



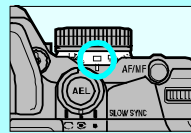

DRIVE

Continuous drive, exposure bracketing, multiple exposures, and other options can be selected using the drive-mode lever.



The standard drive-mode setting for this camera is single-frame (drive-mode lever set to ).

The selectable modes are represented by;

-  (Single-frame advance)
-  (Continuous advance)
-  Bracketing
 - S (Single frame advance)
 - C (Continuous advance)
-  Self-timer
-  Multiple Exposure

- The drive-mode lever can not be changed while pressing the exposure-mode dial lock-release button.

CONTINUOUS

This camera has both single-frame and continuous advance drive modes. Select single-frame advance to expose and advance the film one frame at a time. Switch to continuous drive to photograph dynamic action sequences at up to 4 frames per second in high speed mode (3.7 when AF-A or AF-C is selected) or 2 frames per second in low speed mode.

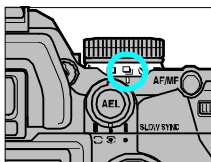

1. Turn the drive-mode lever to the desired drive mode.

- Single-Frame Advance
- Continuous Advance

If continuous advance is selected...

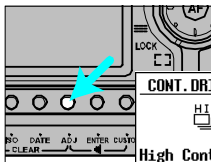

2. Open the control-panel door, then press the adjust button.

- The display will switch to the setting display.

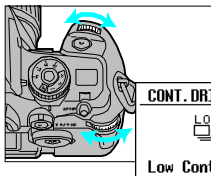

3. Turn either control dial to select high or low speed continuous drive.

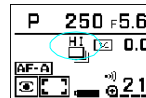

- Press the shutter-release button partway down to enter the setting. HI remains for high continuous, LO remains for low continuous mode.

4. Keep pressing the shutter-release button to take the pictures.

- The high or low setting will remain selected until you change it.
- When the built-in flash is up or an accessory flash is on, the shutter can not be released until the flash is charged.
- The shutter can not be released until the camera has focused on your subject.
- If AF-S (Single-shot autofocus) is selected, focus will be locked until the series of continuous frames is finished.
- Return the drive-mode lever to to cancel the continuous drive mode.
- AF Zoom xi and Power zoom lenses cannot be zoomed when continuous-advance mode is selected.
- When the battery power is low or in low temperatures, the maximum drive speed may temporarily drop. Continued operation with low battery power may even cause a complete stoppage.

SELF-TIMER

Use the self-timer to delay the shutter release for 2 or 10 seconds (approx.) after the shutter-release button is pressed all the way down. In addition to delaying release of the shutter, the 2 second delay pops the mirror up two seconds before the shutter opens to reduce blur caused by camera vibration.

- Attach the eyepiece cap (p.127) when there is a bright light source behind the camera.

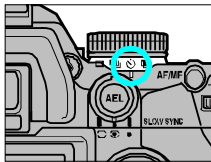

1. Place the camera on a tripod, then turn the drive-mode lever to .

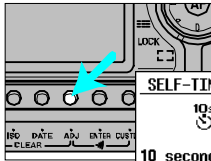

2. Open the control panel door and press the adjust button.

- Self-timer set display appears.

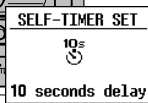

10 seconds delay

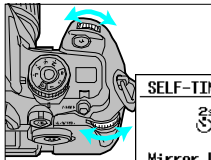

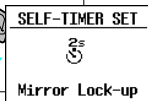

3. Turn either control dial until the desired delay appears in navigation display.

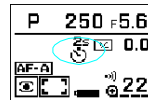

Mirror Lock-up



- Press the shutter-release button partway down to enter the setting.  2s remains for 2 second delay,  10s remains for 10 second delay.

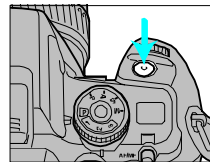

4. Center your subject in the focus frame, then press the shutter-release button partway down to confirm the focus.

5. Press the shutter-release button all the way down to start the timer.

- 10 seconds (10 s) –The self-timer lamp on the front of the camera will blink slowly, then blink rapidly just before the shutter releases.
- An audio sound will also be heard for the 10 second self-timer. It can be canceled if desired (p. 131).
- Turn the camera off or select another drive mode to cancel the 10 second self-timer.
- 2 seconds (2 s) –The mirror pops up when the shutter-release button is pressed all-the-way down. The shutter is released two seconds later.
- The 2 second self-timer cannot be cancelled.
- The red-eye reduction flash mode is not effective when the 2 second self-timer is selected.

EXPOSURE BRACKETING

Exposure bracketing automatically exposes a series of frames with exposures above and below the metered exposure value. Bracket your exposures when shooting slides and other films with a low tolerance for exposure error. A larger bracketing increment is recommended when shooting negative film.

- This camera can expose a 3, 5, or 7 frame brackets in increments of 0.3, 0.5, 0.7, or 1.0 EV.

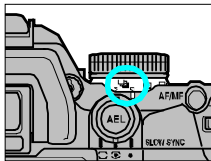

1. Turn the drive-mode lever to the desired bracketing mode.
 - S - Single Frame Advance
 - C - Continuous Advance

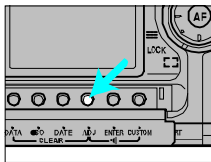

2. Open the control-panel door, then press the adjust button.
 - The current bracketing increment and size of the bracket is shown in the display.

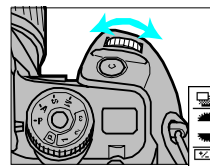
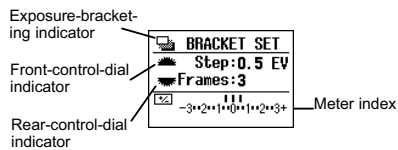

3. Turn the front control dial to set the bracketing increment (0.3, 0.5, 0.7, 1.0 EV).

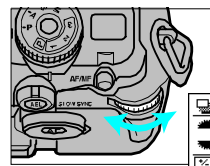
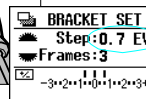

4. Turn the rear control dial to set the size of the bracket (3, 5 or 7 frames).

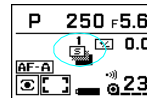
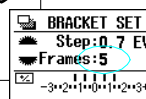

- Press the shutter-release button partway down to enter the setting. remains for single frame advance, remains for continuous frame advance mode.

5. Compose (and meter) your subject, then press the shutter-release button all the way down to start the bracketing.

- In S - Single-frame advance, press the shutter-release button for each exposure.
- In C - Continuous advance, hold the shutter-release button until the series is finished.

EXPOSURE BRACKETING

- To cancel, move the drive-mode lever to a different mode.
- The normal sequence (for a 5 frame bracket in 1/2 increments) is:
Normal → -0.5EV → +0.5EV → -1.0EV → +1.0EV
 However by selecting Custom 11-2, the following sequence is possible; (p 169.)
-1.0EV → -0.5EV → Normal → +0.5EV → +1.0EV
- Exposure is locked on the first frame of the series.
- P mode (programmed autoexposure) exposures are bracketed by changing both the aperture and shutter speed.
- S (shutter priority) mode and Ps mode exposures are bracketed by changing the aperture.
- M mode (manual), A mode (aperture priority) and PA mode exposures are bracketed by changing the shutter speed.
- Press the AE-lock button when the shutter is released to bracket using the aperture in manual (M) mode.

Single Frame Advance

- The number above the bracket indicator in the display and also in the viewfinder, increases each time you take a picture.
- Film can be changed in the middle of the bracketed series.
- Turn the camera off, or select another drive mode to cancel single frame advance bracketing.

Continuous Advance

- Removing your finger from the shutter-release button before the series is complete resets the camera to the first frame of the bracket.
- Continuous advance bracketing is cancelled at the end of the roll.

Meter Index

When bracketing is selected, the meter index appears in the viewfinder.

- If exposure compensation is also selected, the whole bracketing series will be shifted.
- Meter index doesn't appear in the viewfinder while adjusting the increment and size of the bracketing.
- Every time the picture is taken, the corresponding bar will disappear.

 -3••2••1••0••1••2••3+	 -3••2••1••0••1••2••3+
Bracketing increment - 0.7EV Size of bracket - 3 frames	Bracketing increment - 0.5EV Size of bracket - 5 frames Exposure compensation - +1.0EV

- If a 1/2EV exposure increment is selected with a 0.3 or 0.7EV exposure bracketing increment, or if a 1/3EV exposure increment is selected with a 0.5EV exposure bracketing increment, then the position of the bar in the meter index shown in the viewfinder will be slightly shifted. However, the exposure will be exactly as set.



- If you press the display-selection button, the meter-index display appears in the navigation display. Exposure bracketing index is shown in the upper mid-area with .

With the exposure history display, the next exposure value is reversed printed to tell you that camera setting is different.

23		3.5	0.0
22	125	3.5	+0.5
21	200	3.5	0.0
20	250	3.5	-0.5
19	350	3.5	-1.0
18	90	8	0.0

Dial setting only. The actual bracketing value may not be as indicated in the reverse printed area.

Actual exposure values for the previous 5 exposures.

MULTIPLE EXPOSURE



The multiple exposure function makes it possible to expose 2 or more images on the same frame.

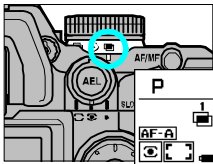

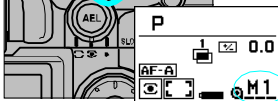

1. Turn the drive-mode lever to .

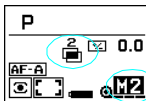

• M.1 appears in the display's frame counter.

2. Compose the scene, then press the shutter-release button all the way down to take the first exposure.



- After the first exposure, **M.2** appears in the display and is reverse printed telling you that the next exposure will be overlapped.
- Take additional exposures as desired.
- Additional exposures are counted only up to **M.9**, but an unlimited number of exposures can be taken.
- The number on the  also increases up to 9.

3. Select another drive mode to cancel multiple exposure mode and to advance the film to the next frame.

The meter in your camera determines exposure (EV) based on the assumption that only one exposure will be made on each frame. When making multiple exposures, the EV for each additional exposure may need to be reduced or over exposure can result.

Compensate the exposures as follows:

Number of Exposures	1	2	3	4	6	8
Exposure Adjustment	0	-1	-1 1/2	-2	-2 1/2	-3

- The above corrections are intended as a general guideline. Some testing may be necessary to produce the desired results.
- Compensation may not be necessary if all of the exposures have dark backgrounds and the subjects of the exposures will not overlap.
- Exposure can be compensated in 1/2 or 1/3 EV increments using the exposure compensation function (p. 77).
- The camera can be turned off and back on during a multiple exposure series.
- When date/time imprinting is selected, the date/time will be printed when the film is wound.
- When using negative film, tell your photofinisher there are multiple exposures on the roll. Some photofinishers may not automatically print multiple exposure.
- If Custom 3-2 is selected, you can partially rewind the film and overlap an exposure on a previously exposed frame (p. 161-163).

FLASH

This section of your manual covers the operation of accessory flashes as well as the built-in flash.

The high accuracy of your camera's flash metering is realized by ADI (Advanced Distance Integration) flash metering in combination with the newly developed D flash units and D lenses. Flash metering is controlled by the guide number in addition to pre-flash metering. Compared with the conventional TTL flash metering, flash output is less influenced by the background conditions or the subject's reflectance in ADI flash metering, offering optimum flash metering.

Your camera's built-in flash provides coverage for a 24mm angle of view, with a flash guide number of 12.



ADI flash metering



Conventional TTL metering

FLASH MODE SWITCH

Flash pictures can be taken using the built-in flash or with separately sold accessory flash units.

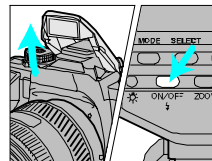

Built-in flash - Raise the built-in flash.

Accessory flash - Turn the accessory flash on.

- In **P** full-auto mode, the flash will automatically fire when necessary. $\frac{1}{2}$ will appear in the navigation display.
- When you are not in **P** full-auto mode, the flash will fire every time. $\frac{1}{2}$ will appear in the navigation display.

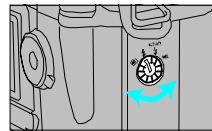

- The flash-mode switch has four positions.

	Built-in flash	Program Flash
	Red-eye reduction (p. 100)	Normal flash
	Normal flash (p. 31)	Normal flash
REAR	Rear flash sync (p. 101)	Rear flash sync (p. 101)
WL	Wireless/remote flash (p.112)*	Normal flash

* If you use the built-in flash with the flash-mode switch set to WL, the exposure will not be correct.

RED-EYE REDUCTION

When photographing people or animals at night or in other low-light situations, the effect called red-eye may occur due to the flash reflecting off the inside of the subject's eyes. To reduce this effect, the flash fires a series of small bursts before the main flash burst. This causes the subject's pupils to close, greatly reducing the amount of light which will reflect off the retina.

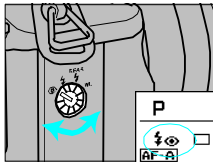

1. Raise the built-in flash and turn the flash-mode switch to .

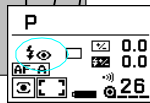

•  appears in the navigation display.

2. Press the shutter-release button to take the picture.

- Warn your subject that the flash will fire a few short bursts just before the picture is taken.
- Red-eye reduction can only be used with the built-in flash.
- Red-eye reduction is not effective when used with self-timer, mirror lock-up function (p. 90).

REAR FLASH SYNC





With rear flash sync

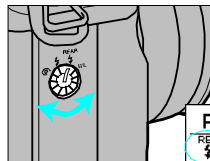

Without rear flash sync

Slow sync flash exposures can appear unnatural because the motion blur precedes the subject in the final image. Use rear flash sync to create more natural looking slow shutter speed flash exposures that leave a blur of motion behind the subject.



1. Raise the built-in flash, or turn the accessory flash on, and turn the flash-mode switch to REAR .



• REAR  appears in the display.

2. Press the shutter-release button to take the picture.

- Flash synchronization returns to front sync (standard operation) when shutter speeds faster than 1/60 are selected.
- Rear flash sync cannot be used with red-eye reduction or wireless flash.

SLOW-SHUTTER SYNC



Slow-shutter sync



Conventional flash

In P and A-modes, slow-shutter sync sets a slower shutter speed to increase the background or ambient exposure in a flash picture. Flash output is automatically decreased to maintain correct subject exposure.

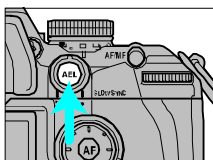

1. Raise the built-in flash or turn the accessory flash on.
2. While pressing the AE-lock button, press the shutter-release button all the way down to take the picture.

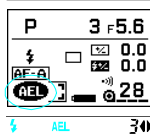

- AE-L and the locked exposure will be displayed in the display and the viewfinder.
- The shutter speed may not be reduced if the background is bright or a large aperture is set (A-mode).
- Use a tripod if the shutter speed becomes too slow to allow sharp, hand-held pictures.
- Custom 10-2 lets you press the AE-lock button once to activate slow-shutter sync. Press again to cancel (p. 168).

FLASH COMPENSATION

Use flash compensation to increase or decrease the output of the built-in or an attached accessory flash up to ± 2 EV in 1/2EV increments. This function is especially useful when shooting with slide film, because of the film's low tolerance for exposure error.

Flash compensation changes the flash exposure by the amount set relative to the ambient exposure.

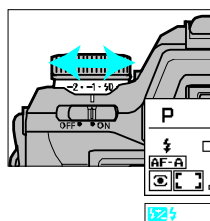

Rotate the flash-compensation dial to the desired compensation value.

- Selected compensation values appear in the navigation display.
-  appears in the viewfinder.

- Flash compensation does not modify the output of a flash set to manual flash or connected to the PC terminal.
- Flash compensation has no effect on the ambient light exposure.
- Flash compensation and exposure compensation can be used together. See page 80 for their comparison.
- Over exposure, using flash compensation, may not be possible with the built-in flash.

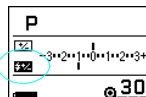

- If you press the display-selection button, the meter-index display appears in the navigation display. The flash compensation index is shown in the lower mid-area with .

FLASH BRACKETING

Flash bracketing lets you expose a series of frames with exposures below and above the normal metered exposure while using flash. You can choose a series of 3, 5, or 7 frame flash exposure brackets in 0.3, 0.5, 0.7, or 1.0 EV increments. Exposures are bracketed by controlling the flash output.

- A larger bracketing increment is recommended when shooting negative film.

1. Raise the built-in flash or turn the accessory flash on.

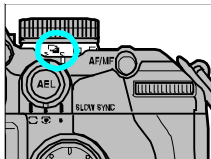

2. Turn the drive-mode lever to single-frame advance (S) or continuous-frame advance (C) bracketing mode.

- The shutter-release button must be pressed for each exposure, even when the lever is in the (C) position.

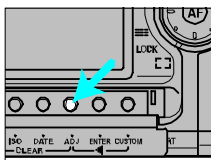

3. Open the control-panel door, then press the adjust button.

- The set display appears in the navigation display.

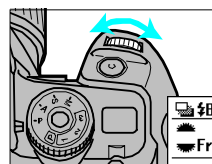
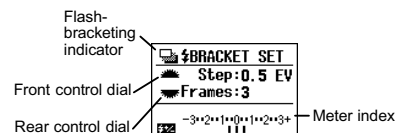

4. Turn the front control dial to set the bracketing increment (0.3, 0.5, 0.7, 1.0 EV).

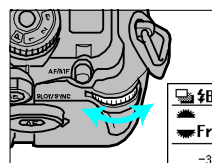
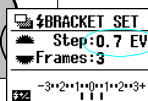

5. Turn the rear control dial to set the size of the bracket (3, 5 or 7 frames).

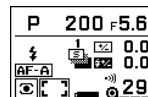
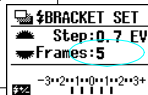

- Press the shutter-release button partway down to enter the settings. \square or \square remains in the display while flash bracketing is set.

6. Compose your subject and press the shutter-release button all the-way-down to take the picture.

7. Repeat step 6 until the series is complete.

- Turn the camera off, change the drive mode, push the built-in flash down to cancel the bracketed series.

order manuals online at: realeasybay.com/manuals

FLASH BRACKETING

- The normal sequence (for a 5 frame bracket in 1/2 increments) is:
Normal → -0.5EV → +0.5EV → -1.0EV → +1.0EV
However by selecting Custom 11-2, the following sequence is possible; (p 169.)
-1.0EV → -0.5EV → Normal → +0.5EV → +1.0EV
- The number above the bracket indicator in the display and also in the viewfinder, increases each time you take a picture.
- Film can be changed in the middle of the bracketed series.
- Bracketing towards overexposure may not be possible with the built-in flash.

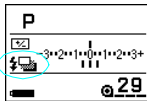

- If you press the display-selection button, the meter-index display appears in the navigation display. The flash bracketing index is shown in the lower mid-area with .

ACCESSORY FLASH

By using an optional accessory flash, such as the 5600HS(D), you can get improved flash performance over the built-in flash. The accessory flash units fit in the shoe located on the top of your camera.

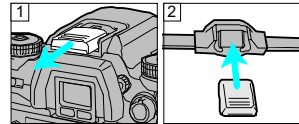

- Your camera comes with an accessory shoe cap which protects the accessory shoe contacts. When using a flash or other accessory, remove the accessory shoe cap (1) and store the shoe cap into the eyepiece cap for safekeeping (2).
- The flash signals for the accessory flash are the same as those for the built-in flash (p. 31).
- Refer to the specific instruction manual for each accessory flash to obtain the flash range. For the 5600HS(D), 5400HS, and 5400xi, the flash range will also appear in their data panels.

FLASH

FLASH METERING

Flash metering changes according to the flash unit and lens being used.

	D lens	Other lenses
5600HS(D) 3600HS(D)	ADI metering (HSS on, with pre-flash)	Pre-flash metering (HSS on)
5400HS	Pre-flash metering (HSS on)	Pre-flash metering (HSS on)
Other accessory flashes	TTL metering	TTL metering
Built-in flash	ADI metering (without pre-flash)	TTL metering

- When the shutter speed is faster than 1/200 sec, flash metering will be HSS-TTL. If Wireless/Remote flash is set, metering will be Wireless/Remote-TTL.

TTL metering (Through-the-lens):



The TTL flash metering system determines the flash exposure automatically.

Pre-flash metering:

A pre-flash fires before the main exposure. The preflash is metered (14 segment) and fed back to the flash exposure system to more accurately determine the flash exposure.

ADI metering (Advanced Distance Integration):

Flash metering is controlled by the guide number in addition to TTL metering. Flash output is less influenced by the background conditions or the subjects reflectance.



When using an accessory flash with HSS function, and if HSS is turned on, then pre-flash fires and ADI/Pre-flash metering will occur (blue area of the chart ). When using a D lens, ADI metering is also done using the built-in flash ( area).

- TTL 4-segment flash metering will be used instead of ADI/Pre-flash metering, when HSS is off, bounce flash is set, or when an off-camera cable is used to connect multiple flash units. TTL average metering will be used instead of ADI/Pre-flash metering when rear flash or the mirror lock-up function is selected.

Use of a Flash/Color Meter with Pre-Flash

When pre-flash fires, a flash/color meter cannot meter accurately. This is because the purpose of pre-flash is to assist ADI/Pre-flash-metering, not to provide illumination for the picture. Cancel HSS (see flash manual) or eliminate the influence on metering using Custom 20-2/3 (p. 175). Those items affected are in  in the chart on page 108. However, if you use the test-flash button on the flash, the pre-flash will not fire.

When Using a Close-up Diffuser, Certain Filters and Lenses

When close-up diffuser CD-1000, or a filter whose stop's increase is not 0 (i.e., ND) is used, or when the focus-range limiter or macro release of certain lenses are used, the proper exposure will not be obtained by ADI or Pre-flash metering. For those items in  (p. 108), cancel the HSS or choose Custom 20-2/3. When using the built-in flash , you must choose Custom 20-2/3.

- Custom 20 gives you the choice of (1) ADI 4-segment flash metering, (2) TTL 4-segment flash metering, (3) TTL average flash metering (p. 175).

order manuals online at: realeasybay.com/manuals

HIGH-SPEED SYNC



High-speed sync



Conventional-fill flash

The maximum sync speed for this camera is 1/200. However, with the 5600HS(D), 5400HS, and 3600HS(D) accessory flashes (sold separately) shutter speeds up to 1/8000 can be used. High-speed sync (HSS) allows faster shutter speeds when fill flash is used on moving subjects outdoors. HSS also lets you use large aperture/high shutter-speed combinations to separate your subject from the background by limiting the depth-of-field.

Attach the 5600HS(D), 5400HS or 3600HS(D) and set it to HSS mode.

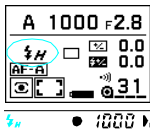

- **H** automatically appears in the viewfinder and the navigation display at shutter speeds faster than 1/200 sec when the 5600HS(D), 5400HS, or 3600HS(D) is attached.

- When using flash and color meters, high-speed sync is not possible. Turn the flash's HSS off or use a shutter speed of 1/200 second or slower.
- Shutter speeds faster than 1/200 second are not available when the 2 second self-timer or rear flash sync has been selected.

FLASH

WIRELESS/REMOTE OFF-CAMERA FLASH



Normal Flash

Wireless/Remote Flash is available with the Minolta 5600HS(D), 5400HS, 3600HS(D), 5400xi, and 3500xi accessory flashes. Wireless/Remote flash lets you experience the creative control available with an accessory flash.

In Wireless/Remote flash mode, the off-camera flash is triggered by a coded signal from the camera's built-in flash when you press the shutter-release button. When proper exposure has been received, another signal cuts the accessory flash off.



Wireless/Remote Flash

You can also achieve a 2:1 lighting ratio automatically. When remote ratio flash is selected, the off-camera flash provides 2/3 of the full exposure while the built-in flash provides the remaining 1/3.



Wireless/Remote Ratio Flash

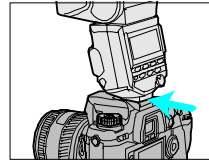

1. Attach the accessory flash to the camera, then turn the camera and the flash on.

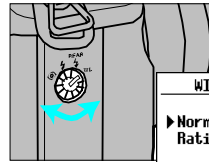

2. Turn the flash-mode switch to WL.

• The wireless set display appears in the navigation display.

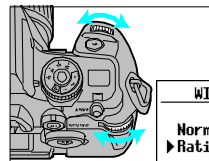

3. Turn either control dial and select normal wireless or ratio.

- Normal Wireless : When selected, only the accessory flash fires.
- Ratio: When selected, the built-in flash will provide 1/3 and the accessory flash will provide 2/3 of the total exposure.

WIRELESS/REMOTE OFF-CAMERA FLASH

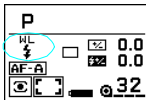

4. Press the shutter-release button partway down.

- Navigation display returns to the previous display.
- WL appears in the display.

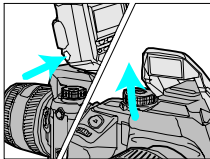

5. Detach the accessory flash, then raise the built-in flash.

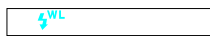

- WL appears in the viewfinder.

6. Position your camera and flash unit using the information on this page.

- Wireless/Remote flash is most effective when used in dark or poorly lighted areas.
- Refer to your flash instruction manual for more detailed flash to subject distance information.

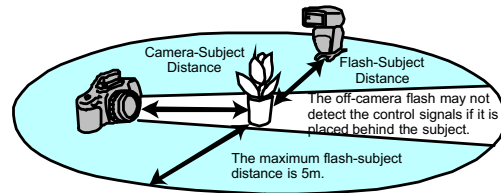

	Camera - subject	Flash - subject			
		Non HSS		HSS	
Shutter speed	All shutter speeds	- 1/60	1/60 - 1/200	1/250	1/1000
Aperture					
2.8	1.4 - 5m 4.6 - 16 ft.	1.4 - 5 m 4.6 - 16 ft.	1 - 5 m 3.3 - 16 ft.	1 - 5 m 3.3 - 16 ft.	1 - 2.5 m 3.3 - 8 ft.
4	1 - 5m 3.3 - 16 ft.	1 - 5 m 3.3 - 16 ft.	1 - 5 m 3.3 - 16 ft.	1 - 3.5m 3.3 - 11.5 ft.	1 - 1.7m 3.3 - 5.5 ft.
5.6	1 - 5m 3.3 - 16 ft.	1 - 5 m 3.3 - 16 ft.	1 - 5 m 3.3 - 16 ft.	1 - 2.5m 3.3 - 8 ft.	1 - 1.2 m 3.3 - 3.9 ft.

- The table above is for ISO 100 film. Distance will be double if you are using ISO 400 film (maximum 5m/16 ft).
- HSS is possible only with D flash.

WIRELESS/REMOTE OFF-CAMERA FLASH

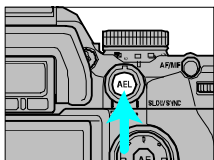
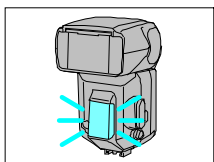
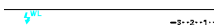

7. Wait until both flash units are fully charged.
 - appears in the viewfinder when the built-in flash is charged.
 - When the off-camera flash is charged, its AF illuminator will blink.

8. Press the AE-lock button to test fire the accessory flash.
 - Caution; Test firing the flash will activate slow-shutter sync (p. 102) if Custom 10-2 (p. 168) is selected. Custom setting 10-1 is recommended.
 - If unsuccessful, change the position of the camera or the flash.

9. Press the shutter-release button all the way down to take the picture.

• There is no limit for shutter speed when using 5600HS(D)/3600HS(D) in normal wireless, as these have high-speed sync capability in wireless/remote off camera flash mode. However, in wireless ratio mode or when using 5400HS, 5400xi, or 3500xi in wireless/remote flash mode, the shutter speed should be 1/60 second or slower.

Switching Between Normal WL Flash and Ratio WL Flash

1. Turn flash-mode switch to a position other than WL and then back to WL.
2. The wireless set display appears in the navigation display. Select normal or ratio-flash by turning either the front or rear control dial.

Canceling the Wireless/Remote Flash

1. Attach the accessory flash to the camera, and turn both the camera and flash on.
2. Turn the flash-mode switch to a position other than WL.

Wireless/Remote Flash Using more than one flash

Wireless/remote flash with two or more accessory flashes is also possible. If you use both a D series flash and a non-D series flash, attach a non-D flash to the camera and set wireless mode. Otherwise, the non-D flash doesn't fire.

Additional Wireless/Remote Flash Options

In addition to the procedure described on p. 112-116, where the built-in flash acts as the controller, there are two other ways in which wireless/remote flash can be used;

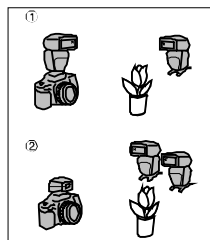

- ① Using 2 accessory flashes with one (5600HS(D), 5400HS, or 5400xi) attached to the camera acting as the controller, the other accessory flash acting as an off-camera flash.
- ② Using a Wireless/Remote Flash Controller as the controller, and one or more accessory flash as an off-camera flash.

order manuals online at: realeasybay.com/manuals

PC TERMINAL

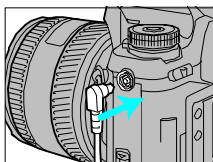

Flash units which can not be connected to the accessory shoe can be connected to the camera via the PC terminal.

- Set the exposure mode dial to M.
- Set the shutter speed to 1/200 or slower.

- The flash unit may fire unexpectedly if it is on when the sync. cord is plugged into the PC terminal.
- TTL flash metering does not function when the flash is connected to the PC terminal.
- Flash compensation is not possible. However, flash bracketing is possible if you press the AE-lock button while taking a picture.
- The PC terminal is compatible with both center positive (normal polarity) and center negative (positive polarity) flash units.
- When using the PC terminal, rear flash sync can not be used.

ADDITIONAL FEATURES

ADDITIONAL FEATURES

DATE/TIME IMPRINTING

The Quartz-data function lets you record the date or time onto the lower left-hand corner of the photograph. The automatic calendar is good through the year 2039.



Approximate location of print area.

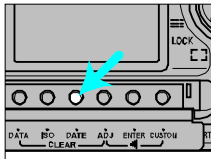

1. Open the control-panel door and press the DATE button.

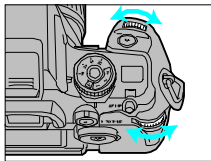

2. Turn the front or rear control dial to select the date you want.

• The display changes as follows;

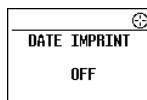

No printing

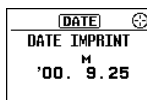

Date printing

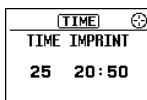

Time printing

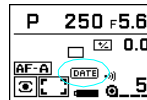

- When you press the shutter-release button partway down, the display returns to the previous display.
- If the printing option is selected, **DATE** or **TIME** remains in the navigation display.
- "M" appears over the month.

- Imprinted data may be difficult to read if the lower left area of the photograph is bright or non-uniform.
- Printing intensity can be changed using Custom 33 (p. 186).
- Imprinting may not be done or it may be overlapped on the last frame of a roll.
- The sequence of the date off, date on, and time imprint displays can also be controlled using the focus-area selector.

Setting the Date/Time

- If the camera batteries are removed for a long period of time, the date/time may have to be reset.

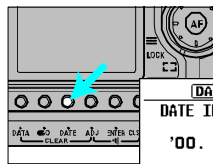

1. Open the control-panel door and press the DATE button.

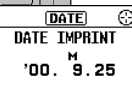

- The date imprint window appears in the navigation display.

DATE/TIME IMPRINTING

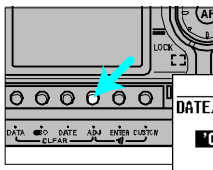

2. Press the ADJ button.

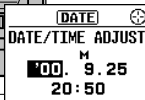

• The date adjust window appears and the year is high-lighted.

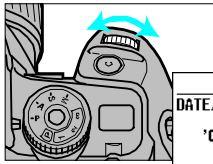

3. Turn the front control dial to selected the item you wish to change.

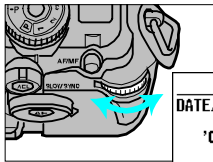
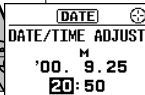

4. Turn the rear control dial to change the value.

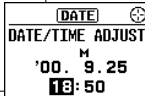

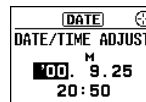

- Repeat steps 3 and 4 until the correct date/time is set.
- After all items are set, press the shutter-release button partway down. The normal display returns.

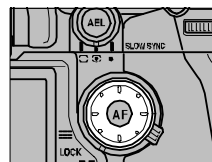

When  appears at the top right side, it is possible to use the focus-area selector instead of the dial.



 If you press the right/left side of the selector, the high-lighted area moves.

 If you press the top/bottom side of the selector, the high-lighted value changes.

• Display returns to normal when you press the shutter-release button partway down.

After the camera batteries have been installed for two days, a second battery (non-accessible) will have been charged. This second battery will be able to provide power to retain the date/time settings for approximately 6 months should the camera's batteries be removed. After that, this message appears and the date/time information will not be imprinted, and must be set. See pages 121-122 for instructions for setting the date and time.

((()))
Press [ADJ] to set date and time.

DATE/TIME IMPRINTING

Changing the Format

The order of the year/month/day can be changed.

1. Open the control-panel door and press the DATE button.
 - The date imprint window will appear in the navigation display.
2. Hold the ADJ button for 3 seconds. The year, month, and day will appear high-lighted.
3. Turn either the front or rear control dial to select the desired format.
4. Press the shutter-release button partway down to save the desired format.

EYE-START

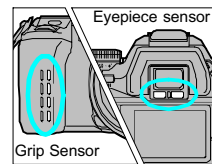

Eye-start automatically activates the camera's focus and exposure systems as you bring the camera to your eye. When an object is detected near the viewfinder, the camera's systems are activated to set the focus and exposure as you frame your subject.

Using Eye-Start

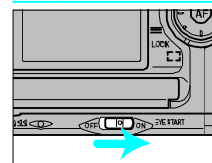

1. Slide the eye-start switch to ON.
 - The grip sensor is activated.
2. Turn the main switch to ON.
 - Touching the grip sensor activates the eyepiece sensor.
3. When an object is detected near the viewfinder, the camera's systems are activated to set the focus and exposure as you frame your subject.
 - Autofocus and exposure systems shut down approx. five seconds after eye or grip sensor contact is broken.
 - Eye-start may not work properly when using a tripod, gloves, or if your hands are dry. In these cases, press the shutter-release button partway down to activate focus and metering.
 - Infrared absorbing sunglasses may affect eye-start operation.
 - Choose Custom 7- 2 to activate the eyepiece sensor when the main switch is in the ON position (ie; grip sensor is not used) (p.166).

ADDITIONAL FEATURES

TIME EXPOSURES (BULB)



Set the shutter speed to bulb when you want to take time exposures. When selected, the shutter remains open as long as the shutter-release button is held down.

- Mount the camera on a tripod.

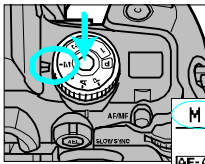

1. While pressing the exposure-mode dial lock-release button, turn the exposure-mode dial to M.

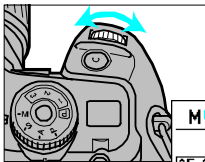

2. Turn the front control dial until BULB appears in the navigation display.

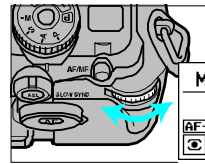
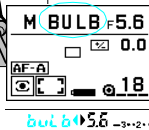

3. Turn the rear control dial to select the aperture.

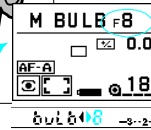

4. Compose your picture.

- If the scene is too dark for autofocus to operate, turn the focus-mode switch to MF and focus the lens manually (p. 48).

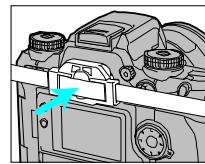

5. Cover the viewfinder with the eyepiece cap.

- The eyepiece cap prevents light from entering through the viewfinder and affecting the metered exposure.

6. Press and hold the shutter-release button to take the picture.

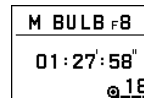

- During the time exposure, the exposure time will be shown on the navigation display.

- To reduce camera blur, attach a remote cord (p. 191).

DEPTH-OF-FIELD PREVIEW

When the lens is focused on a subject, there is a range behind and in front of the subject that appears sharp. This is the depth-of-field. To check how much of your scene will appear in focus, press the depth-of-field preview button. The lens is stopped down to the aperture that appears in the display.

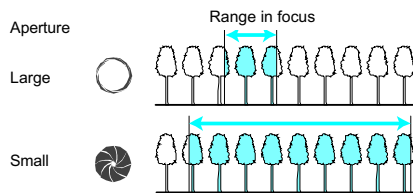

Depth-of-field can be increased by:

1. Using smaller apertures (larger f=stop numbers).
2. Using short focal length (wider angle) lenses.
3. Moving farther away from your subject.

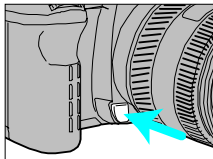

Press the depth-of-field preview button.

- The lens will stop down to the currently selected aperture.
- The viewfinder will appear darker at larger f#s (smaller lens opening).
- The aperture can be changed while the depth-of-field preview button is pressed.

- If you press the depth-of-field preview button after pressing the shutter-release button partway down, the shutter can still be released.
- Cancel by removing your finger from the depth-of-field preview button.

128

- If ∞ blinks or ∞ glows in the viewfinder (ie; focus not confirmed), then the shutter cannot be released.

When using a D lens, and the depth-of-field preview button is pressed, the following information is presented in the navigation display.

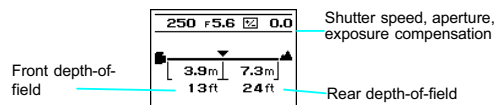

Will be shown if magnification is greater than 1:10 when using a D macro lens.

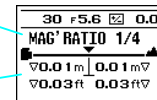

If the D.O.F. is less than 0.01m, ∇ appears.
If more than 20m (66ft), Δ appears.
If near infinity, ∞ appears.

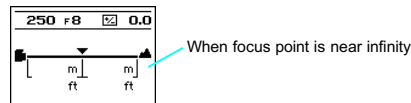

When focus point is near infinity

The magnification ratio is the ratio of the actual size of an object to the size of its image on the film plane. If an object is actually 12 mm in size, and the image is also 12mm in size, then the magnification ratio is 1:1. If the image size is 6mm, then the magnification ratio is 1:2.

ADDITIONAL FEATURES

129

DIOPTER ADJUSTMENT

Turn the diopter adjustment dial to compensate the eyepiece for near or far sighted vision problems. The adjustment range is from -2.5 to +0.5 diopters.

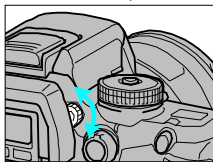

Turn the diopter-adjustment dial until the focus frame appears sharpest.

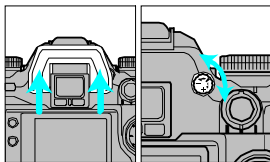

- It may be easier to adjust if the eyepiece cup is removed. Farsighted users – turn the dial clockwise. Nearsighted users – turn the dial counter-clockwise.

- For easier adjusting, before attaching the lens, look through the viewfinder at a well illuminated blank wall or clear blue sky.
- If additional correction is needed, attach a Minolta Eyepiece Corrector (optional accessory) to the camera's eyepiece. There are 4 types available for near sighted and 5 types for far sighted vision.

SETTING/CANCELLING THE AUDIO

Your camera has the capability of producing an audio tone to let you know when focus is confirmed and locked. It can also sound when using the self-timer mode.

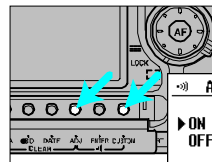

1. Open the control-panel door and simultaneously press the ADJ and CUSTOM buttons.

- The audio set display will appear.

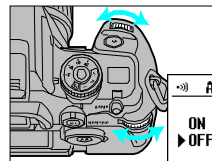

2. Turn either the front or rear control dial to select audio ON or OFF.

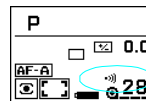

- The navigation display returns to the previous display when the shutter-release button is pressed partway down. «)» appears when audio is selected.

- When audio ON is selected, a tone will be heard when: Focus is confirmed - 2 short beeps, except when the subject is moving, or when AF-C is set. Self-timer countdown - will beep slowly at first, then rapidly, and finally a solid tone just before the shutter releases.

MEMORY

The memory function allows you to store a variety of camera settings as a group and recall them at any time. Three different set of camera function settings can be stored.

- Each of the following can be stored in memory. See the appropriate section for details.
 - Exposure mode
 - Focus mode/Focus area
 - Metering mode
 - Exposure compensation/Flash compensation
 - Drive mode
 - Flash mode
 - AF priority/Release priority

MEMORY

The following settings will be stored in your camera by using the memory function.

- Exposure mode (P, A, S, M)
- Shutter speed in S mode, aperture in A mode, shutter speed and aperture in M mode
- Focus mode (AF-A, AF-C, AF-S, Manual focus)
- Focus area (wide focus area, local focus area)
- Metering mode (14-segment honeycomb-pattern, spot, center-weighted average)
- Exposure compensation value
- Flash compensation value
- Film drive mode (single-frame, continuous, bracketing, self-timer, multiple exposures)
- The adjust button settings for the drive mode (continuous and bracketing). Increment and size will be stored independently for the exposure bracketing and flash bracketing.
- Flash mode with the built-in flash (normal, red-eye reduction, rear flash sync, wireless/remote flash). However, whether the built-in flash was on or off will not be stored.
- AF/Release priority (Custom 1 setting)
- Tasking on focus mode dial, AF-A position (Custom 22 setting)

When using the memory function, you cannot choose to have only part of the above settings stored. All of them will be stored automatically. No other settings will be stored in memory. eg: date imprinting, display contrast, custom function settings (other than #1 or #22), etc.

MEMORY

Your camera is capable of storing three different sets of camera function settings. This feature is convenient when you will be repeating the same shooting conditions and want to use the same settings each time.

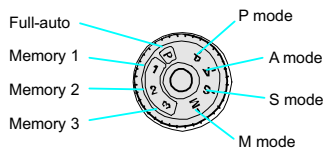

When positions 1, 2, 3, or full-auto are selected, the settings of the controls do not necessarily correspond to the actual camera settings. The upper part of the display turns black to let you know.

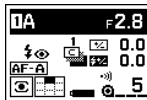

- Beautifully defocused images can be produced using the STF (Smooth Trans Focus) mode, which can be used instead of memory 3 . See page 180.

STORING MEMORY

When first purchased, standard settings are stored in memory 1, 2, and 3. This section shows you how to store new settings into memory.

- It is not necessary to use all three memory settings.
- The stored memory settings are not affected by turning the camera off or by removing the batteries.

Storing New Settings In Memory

1. Set the camera with all the function settings you want to store. See page 133.

- Full-auto [P] settings can not be stored.

2. Open the control-panel door and press the enter button.

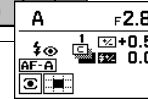
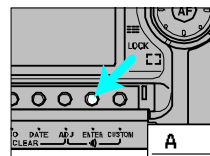

- While pressing the enter button, the display shows only the settings to be stored.

- This display will appear when your finger is removed from the enter button.

STORING MEMORY

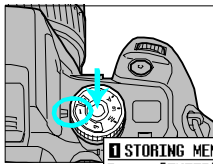

STORING MEMORY
Press [ENTER] again to store settings in memory [1].

3. While pressing the exposure-mode dial lock-release button, turn the exposure-mode dial to 1, 2, or 3.

- If the exposure-mode dial is turned to 1, this display appears.
- Memory position 3 is not available if STF mode has been selected by Custom 25-2 (p. 180).

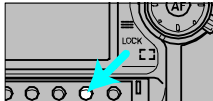

STORING MEMORY
Settings have been stored in memory [1].

4. Press the enter button again.

- This display appears for 5 seconds. Settings are now stored.

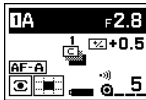

RECALLING SETTINGS IN MEMORY

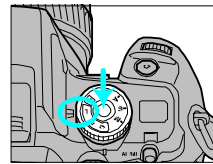

1. While pressing the exposure-mode lock-release button, turn the exposure-mode dial to positions 1, 2, or 3.

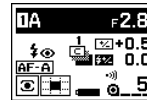

- Stored settings will be displayed for 5 seconds.
- Upper part of the display turns black indicating that the control settings may not match the actual camera settings.

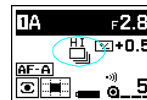

Additional changes are still possible after recalling.
Example: Changing the drive mode setting to continuous mode.

- Pressing the enter button after the change overwrites the previous setting.
- The additional changes will be cancelled if the exposure-mode dial is turned or the main switch is turned to OFF.

CHANGING THE STORED SETTINGS

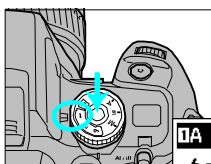

1. While pressing the exposure-mode dial lock-release button, turn the exposure-mode dial to positions 1, 2, or 3.

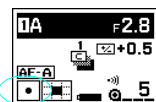

2. Change the camera settings using dials or levers.
Example: Going from 14-segment honeycomb-pattern metering to spot metering.
 - It is possible to take a picture at this point.

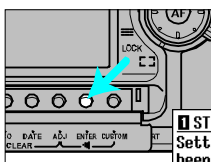

3. Press the enter button.

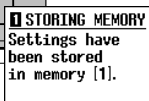

- This display appears for 5 seconds. Settings are now stored.

- If only the exposure mode is to be changed, follow these steps.
1. Turn the exposure-mode dial to positions 1, 2, or 3.
 2. While pressing the exposure-mode dial lock-release button, turn the front or rear control dial until the desired mode appears.
 3. Press the enter button.

Returning to Standard Settings

Clearing the memory in 1, 2, and 3, will result in the settings returning to the default settings.

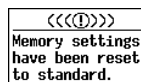

1. Turn main switch to OFF.
2. While pressing the enter button, turn the main switch back to ON.
 - Display shows that the settings have been reset to standard settings.
 - If STF mode had been selected, using Custom 25-2 for memory 3 position, it will not be cancelled.

DATA MEMORY

When selected, the data memory function stores the following information for up to 7 rolls of 36 exposure film.

Data number* (including the body ID number)
ISO value*
Shutter-speed
Aperture
Lens focal length
Smallest f-number
Exposure mode
Metering mode
Exposure compensation value (including exposure bracketing value)
Flash compensation value (including flash bracketing value)
Year/month/date/hour/minute of photograph

Data is recorded for every exposure, except for (*) items which are recorded for every roll.

STORING THE DATA

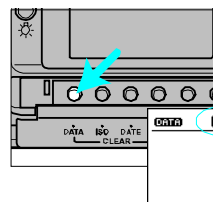

1. Open the control-panel door and press the DATA button.

• Display shows current data memory settings.

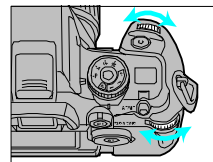

2. Turn the front or rear control dial to select ON.

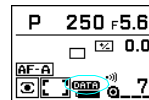
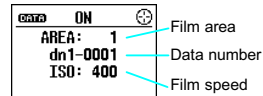

3. Press the shutter-release button part-way down to select data memory function.

• Display shows data-memory-on indicator.

- When you do not want to store data, repeat the above and select off in step 2.
- The stored data memory is not affected by turning the camera off or by removing the batteries.

STORING THE DATA

- Data is not stored unless film is loaded.
- When multiple exposure is selected, only the data of the last exposure will be stored.

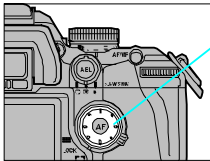
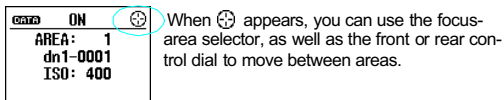

Focus-area selector

- Pressing the selector to the right or up direction, causes the areas to move as follows:
- OFF → On → Area 1 → Area 2 → ... → Area 7 → OFF

- Pressing the selector to the left or down direction, causes the areas to move in the reverse direction as follows:
- OFF → Area 7 → Area 6 → ... Area 1 → ON → OFF

FILM AREA AND DATA NUMBER

The film area and data number are useful in identifying a roll of film and its corresponding data.

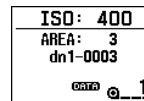

- If data memory is on, this display appears for 5 seconds, when a roll of film is loaded.

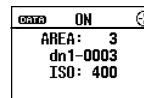

- If you press the data-memory button, you can confirm the current film area.

Film Areas

The data from each of 7 rolls is stored separately in 7 different areas called "film areas". The first roll of film is stored in film area 1, the second in film area 2, and so on. When all the data areas are full, information from the next roll of film will be stored in film area 1, erasing the previous data.

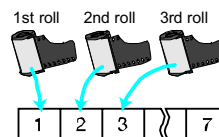

- Data area assignments are not user selectable.

- When the data is deleted, the film area is reset to area 1.

order manuals online at: realeasybay.com/manuals

FILM AREA AND DATA NUMBER

Data Number

In order to identify the photographic data with the developed film, the data number is exposed on the "0" frame when the film cartridge is loaded into the camera (providing data memory has been selected). Each time another roll of film is loaded, the data number increases by 1.

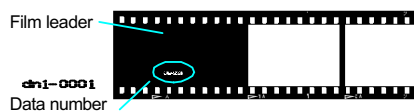

The data number starts at dn1-0001 and increases by 1 for each additional roll of film loaded.

- If data memory is off, the data number will not be printed, but the counter will count up each time a roll of film is loaded.
- To reset the data number, see page 152.
- The third character of the data number (ie; the 1 in "dn1") is changeable and can be used to identify an individual camera body. You can select a number from 1 to 9 by using Custom 34 (page 187).

Comparison of Film Area and Data Number

The 7 film areas indicate where the data is stored and are useful when you want to know how many rolls of film data is stored in the camera.

The data number is used to match the data to the corresponding roll of film. It is printed automatically when a new roll of film is loaded.

Overwriting the film areas

When all 7 film areas are full, the 8th roll of film will be recorded in film area 1, erasing what was previously stored there.

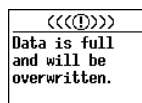

- This warning appears only when the film area changes from 7 to 1. The warning disappears after the first exposure is made.

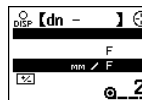

- The old information in the data area is overwritten one frame at a time. A frame between the old and the new information is erased and left blank.

- Data can be transferred to external storage devices by using the Data Saver DS-100. This accessory, which can be purchased separately, attaches to the lens mount for downloading the data.

DATA MEMORY

DATA RECALL

Recorded data is shown on camera display.

Data Readout

1. Open the control-panel door and press the DATA button.

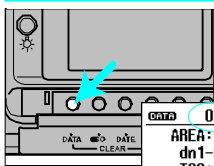

• Display shows current data memory settings.

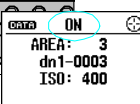

2. Turn the front or rear control dial to select READ, and then the desired film area and data number.

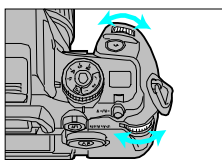
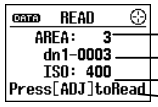

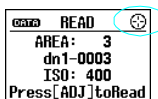

AREA: 3 — Film area
 dn1-0003 — Data number
 ISO: 400 — Film speed
 Press [ADJ] to read — Press the adjust button to recall the data.

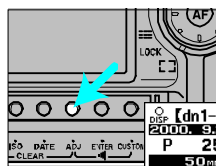

• If  appears, the focus-area selector and spot-AF button can also be used to select the film area (p. 150).

3. Press the ADJ button.





• The 1st frame's data will be shown.

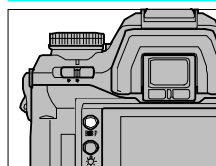

Selecting the Display and Frame

4. Press the display selection button to choose between showing a single frame's data and four frames' data.



• When  appears, switching between the single and four frames data display can be done using the display selection button.

Single frame display



[dn1-0003]			
2000 9.23 10.38			
P 250 F3.5			
50mm / F3.5			
0.0			
0.5			
1			

4-frame display

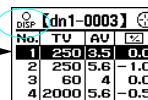

[dn1-0003]			
No.	TU	AU	L2
1	250	3.5	0.0
2	250	5.6	-1.0
3	60	4	0.0
4	2000	5.6	-0.5

DATA RECALL

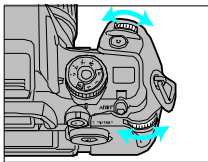

5. Turn the front or rear control dial to select the desired frame.

The single frame display will appear as:

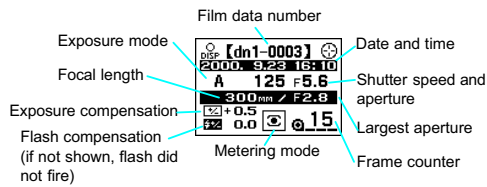

The 4-frame display will appear as:

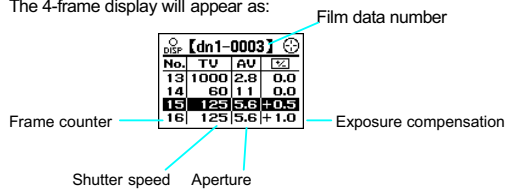

- Every exposure and flash compensation value will include exposure bracketing and flash bracketing values.
- PA, Ps, and STF will be stored as P mode.

Cancelling Data Recall

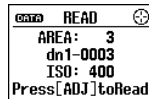

To see other film data, press DATA or ADJ button, then follow step 2 on page 146.

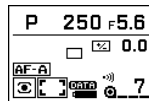

To finish recalling, press the shutter-release button partway down.

- The standard display returns.

DATA RECALL

Using the Focus-Area Selector and Spot-AF Button

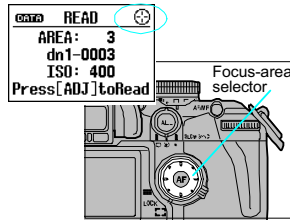

When appears, it is possible to use the focus-area selector and the spot-AF button to select the film areas and data number.

- If the wide/local focus-area switch is at the locked position, the focus-area selector does not work.

Pressing in the directions indicated:

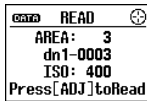

- Moves to the areas as follows:
OFF → ON → Area 1 → Area 2 → ... Area 7 → OFF
- OFF → Area 7 → Area 6 → ... Area 1 → ON → OFF
- If you press the center spot-AF button, when "READ" appears, data can be recalled. This is the same as pressing the ADJ button.

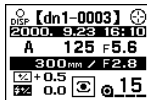

- For the single frame display;
 - Frame number will increase.
 - Frame number will decrease.
- For 4-frame display;
 - Display changes one-by-one.
 - Display changes every 4-frames.
 - The display returns to the data selection display.

DELETING STORED DATA

The data in all of the film areas will be deleted. Film areas cannot be cleared individually.

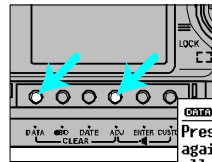

1. Open the control panel door and simultaneously press the DATA and ADJ buttons.

• This display will appear.

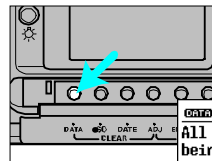

2. Press the DATA button again.

• This display appears while all the data is being deleted.

- Do not operate the camera while data is being deleted.
- The display returns to the standard display after the data in the film area has been cleared.

order manuals online at: realeasybay.com/manuals

DELETING STORED DATA

Film Area and Data Number Reset

Everytime film is loaded, both the film area and data number increases by 1. When you first buy your camera, both are set to 1.

Film area reset:

When the data is deleted (p. 151), the film area returns to 1.

- The data number is not reset when the film area is reset.

Data number reset:

1. Turn the main switch to OFF.

2. While pressing the DATA button, turn the main switch from OFF to ON.

- The last four digits are reset to 0001.
- Data number cannot be reset if the film is in the camera.
- Resetting the data number does not delete the data or reset the film area.

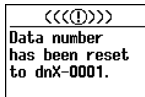

CUSTOM FUNCTIONS

Custom functions let you tailor the camera to your shooting style or preferences. There are 35 custom functions. These are explained on pages 158-187.

CUSTOM FUNCTIONS

CUSTOM FUNCTIONS

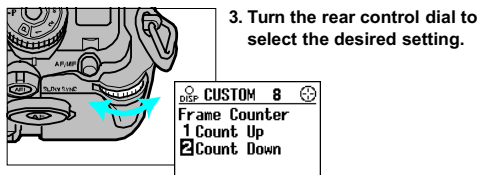
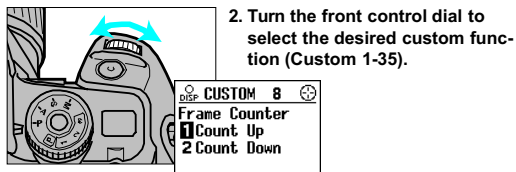
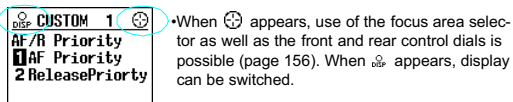
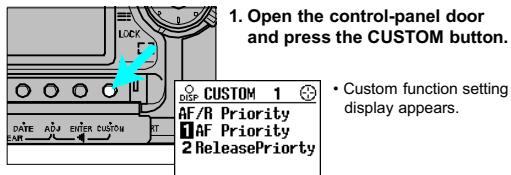

154

4. Press the shutter-release button partway down to enter the settings.

- When you first buy the camera, all custom functions are set to the number 1 setting, except for Custom 33 and 35.
- This manual's explanations assume that these settings have not been changed.
- The custom functions' settings are not affected by turning the camera off or by removing the batteries.

Selecting the Display

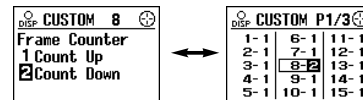
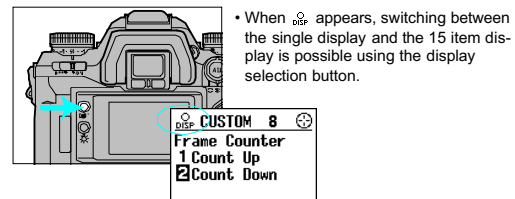

- In either display, select the desired custom function (Custom 1-35) by using the front control dial. Select the desired setting using the rear control dial.

CUSTOM FUNCTIONS

155

CUSTOM FUNCTIONS

Using the Focus-Area Selector and Spot-AF Button

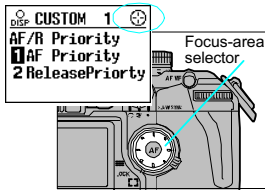

When  appears, it is possible to use the focus-area selector and the spot-AF button to choose the desired custom function and its setting.

- If the wide/local focus-area switch is at the locked position, the focus-area selector does not work.

When the single display appears:

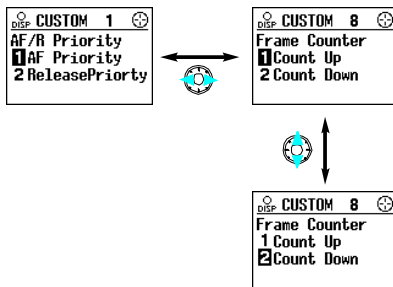

Press the shutter-release button partway down to store the settings.

When the 15 item display appears:

Use both the focus-area selector and the spot-AF button to move between displays and to make selections.

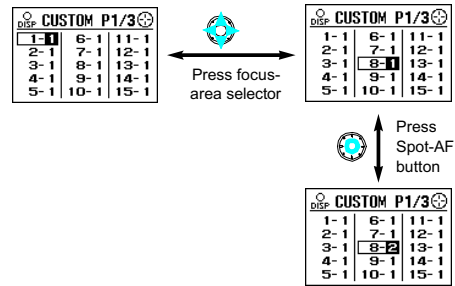

Press the shutter-release button partway down to store the settings.

Resetting Custom Functions to Their Default Settings

This procedure will reset Custom 1 through 32 to setting 1.

• Custom 33, 34, and 35 will not be reset.

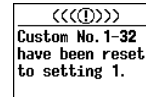

1. Turn the main switch to OFF.
2. While pressing the CUSTOM button, turn the main switch to ON.

CUSTOM 1, 2, 3

Custom 1 - AF/Release Priority

- Custom 1 will be stored in memory if you use the memory function.
- When full auto [P] is selected, focus is always AF priority, even if Custom 1-2 is selected.

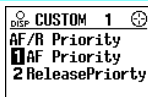

1. AF priority

Shutter will not release unless ● or (M) appears in the viewfinder.

2. Release priority

Shutter releases even if the focus cannot be confirmed. Use release priority when photographing moving subjects.

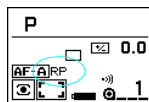

• RP will appear in the display.

Custom 2 - Film Rewind Start

1. Automatic

Film is automatically rewound at the end of the roll.

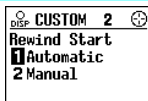

2. Manual

User must press the manual-rewind button to initiate rewind.

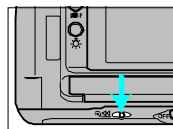

To set custom functions;

1. Open control-panel door and press the CUSTOM button.
2. Turn the front control dial to select the desired custom function.
3. Turn the rear control dial to select the setting.
4. Press the shutter-release button partway down to enter the settings. Refer to pages 154-157 for additional information.

Custom 3 - Film Tip

1. Film is completely rewound into the cartridge.



2. Leader left out after rewind. Camera setup for select-frame film transport.



Select-Frame Film Transport (When partially-exposed film is reloaded)

This custom function allows you to reload a partially exposed roll of film and wind to a desired specified frame.

- Convenient when you want to switch to a different type of film, and the film presently in the camera is only partially exposed.
- The camera cannot detect the beginning of an unexposed frame, so you must remember.
- To avoid overlapping exposures, select 2 frames past the last previously exposed frame.



CUSTOM 3

Example where the roll was previously exposed to the 12th frame. It was rewound, but now the photographer wants to reload and continue shooting. In this example, the film should now be wound to the 14th frame.

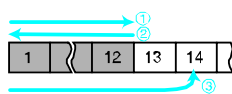

1. Set Custom 3 to setting 2.

2. Load the roll of film that had previously been exposed up through the 12th frame.

- When the roll is loaded, the film will advance to the first frame, and the frame counter will show 1.

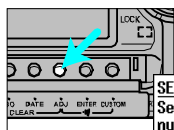

3. Open the control-panel door and press the ADJ button for 3 seconds.

SEL FRAME TRANS
Select frame number by dial and press [ADJ]. 1

- The select-frame film transport display appears.

SEL FRAME TRANS
Select frame number by dial and press [ADJ]. +13 14

4. Turn either the front or rear control dial and select 14.

- When 14 is selected, [+13] will appear in the display, indicating that the film will advance 13 frames.

5. Press the ADJ button.

- The film now advances to the 14th frame.

- Reloading a partially exposed roll increases the risk of film damage (scratches) caused by dust and grit.
- If you keep data memory on, the data number will be overprinted. The data number will not be printed if the data memory is turned off before film is loaded.

160

Select-Frame Film Transport - Rewinding for Multiple Exposures

This feature is useful when shooting multiple exposures with bracketing.

Example showing frame 11 having been exposed and the film advanced to frame 12. A multiple exposure of frame 10 is desired. Using the select-frame transport, the film will be rewound back to frame 10 for the multiple exposure.

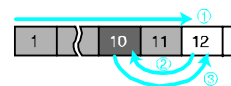

1. Set Custom 3 to setting 2.

2. Open the control-panel door and press the ADJ button for 3 seconds.

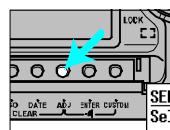

SEL FRAME TRANS
Select frame number by dial and press [ADJ]. 12

- The select-frame film transport display appears.

SEL FRAME TRANS
Select frame number by dial and press [ADJ]. -2 10

3. Turn either the front or rear control dial and select 10.

- When 10 is selected, [-2] will appear in the display, indicating that the film will go back 2 frames.
- The frame counter turns black indicating that you are selecting an exposed frame.

161

CUSTOM 3

Select-Frame Film Transport - Rewinding for Multiple Exposures (continued)

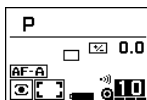

- 4. Press the ADJ button.**
- Film will rewind back to frame 10.



- 5. Take the picture in the 10th frame.**
- Film will advance by one frame and the frame counter remains black indicating that frame 11 is also an exposed frame.

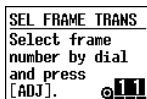

- 6. Press the ADJ button for 3 seconds.**
- The select-frame film transport display appears.

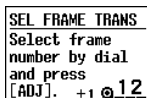

- 7. Turn either the front or rear control dial and select 12.**
- The display shows [+1] indicating that the film will be advanced by 1 frame.
 - Since the 12th frame has not been exposed, the frame counter is no longer black.



- 8. Press the ADJ button.**
- The camera will automatically advance the film to the 12th frame.

- When rewound, subjects may not be positioned exactly as in the previous exposure, as the frame may be shifted a maximum of 1/2 of a perforation hole.
- In the above example, a multiple exposure could also have been taken with frame 11 before going to frame 12.
- Date imprint should be cancelled so as not to overlap the imprints.
- When custom 2-2 is selected, partial rewind is not possible after taking the last picture on the roll.

CUSTOM 4, 5, 6

Custom 4 - DX Memory

1. DX Memory Off

Film speed is always set to the DX-coded ISO. Non-DX-coded film is set to the previous roll's ISO.

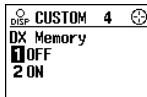

2. DX Memory On

Changes to the film speed for a DX-coded roll are saved and applied to future rolls with the same DX coded ISO. Use to consistently over/under-expose a specific film type.

- Film must be loaded before the ISO can be changed.
- Once you load a roll with a different ISO number, the saved ISO will be cancelled.

Custom 5 - Release Lock (Film)

1. Release Lock Off

Shutter can be released even if there is no film in the camera.

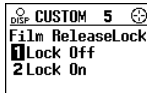

2. Release Lock On

Shutter cannot be released unless film is loaded.

- If the shutter-release button is pressed when film is not loaded, 0 blinks in the viewfinder and this message appears in the display.
- While the back cover is open, the shutter can be released.

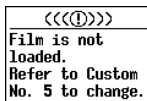

To set custom functions;

1. Open control-panel door and press the CUSTOM button.
2. Turn the front control dial to select the desired custom function.
3. Turn the rear control dial to select the setting.
4. Press the shutter-release button partway down to enter the settings. Refer to pages 154-157 for additional information.

Custom 6- Focus-Hold Button (Lens)

This custom function changes the operation of the focus hold button on the lens. (The mounted lens must have a focus hold button).

1. Focus Hold

Pressing the focus-hold button on the lens locks the focus.

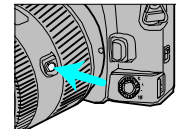

Focus-hold button

2. Continuous Bracketing

Continuous bracketing is set if the focus hold button is pressed while taking the picture.

- Increment and size of bracketing will be the same as that set in exposure bracketing mode (p. 92).
- Flash does not fire.
- If the self-timer or multiple exposure mode is selected, continuous drive will not work.

3. Depth-of-Field Preview

You can confirm the depth-of-field while pressing the focus hold button.

- If not using a D lens, you must press both the focus-hold button and the shutter-release button partway down to confirm the depth-of-field.



CUSTOM 7, 8, 9

Custom 7 - Eyepiece Sensor Activation

When an object is detected near the viewfinder, the camera's systems are activated to set the focus and exposure as you frame your subject.

- Eye-start switch must be on (p. 125).

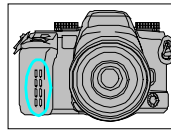

Grip sensor

1. By main switch and grip sensor

Eyepiece sensor is activated when the grip sensor is tripped.

2. By main switch only

Eyepiece sensor is activated when the main switch is in the ON position. Use this setting when the grip sensor is not being tripped (user wearing gloves).

- Slide the main switch to OFF when the camera is not being used.

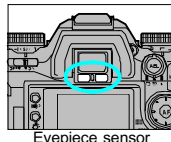

Eyepiece sensor

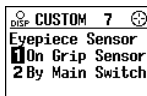

Custom 8 - Frame Counter

1. Frame counter in data panel counts up.
2. Frame counter in data panel counts down.

- The frame counter counts up when non-DX-coded film is loaded.

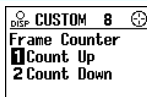

To set custom functions;

1. Open control-panel door and press the CUSTOM button.
2. Turn the front control dial to select the desired custom function.
3. Turn the rear control dial to select the setting.
4. Press the shutter-release button partway down to enter the settings. Refer to pages 154-157 for additional information.

Custom 9 - AF/MF Control Button

This custom function changes the operation of the AF/MF control button.

- Whenever the camera is in the manual focus mode, **MF** appears in the viewfinder.

1. Press to activate, release to cancel. When in autofocus mode, manual focus is set while pressing the AF/MF control button.

When in manual focus mode (MF), autofocus is set and focus is locked while pressing the AF/MF control button.

2. Press once to activate, press again to cancel.

When in autofocus mode, press once to select manual focus. Press again to return to autofocus.

When in manual focus mode (MF), press once to select AF. Press again to return to MF mode.

- Changing the focus mode or turning the camera off and on, cancels the temporary manual or autofocus setting.

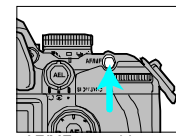

AF/MF control button

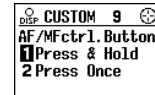

CUSTOM 10, 11, 12

Custom 10 - AE-Lock Button

- AEL appears in the viewfinder and **AEL** appears in the display when AE-lock button is active (down).
- Slow sync is selected when the built-in flash is up or an attached accessory flash is on.
- Manual shift is selected when the exposure mode is set to manual.

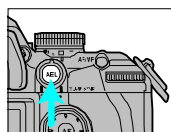

AE lock button

1. Press to activate, release to cancel.
 2. Press once to activate, press again to cancel.
- Turning the built-in flash on or off cancels AE lock.



To set custom functions;

1. Open control-panel door and press the CUSTOM button.
2. Turn the front control dial to select the desired custom function.
3. Turn the rear control dial to select the setting.
4. Press the shutter-release button partway down to enter the settings. Refer to pages 154-157 for additional information.

Custom 11 - Bracketing Sequence

1. **Metered exposure, Underexposure(s), Overexposure(s)**

- A 5 frame bracket in 1/2EV increments is exposed in the following order...

Normal → -0.5EV → +0.5EV → -1.0EV → +1.0EV

2. **Underexposure(s), Metered exposure, Overexposure(s)**
- A 5 frame bracket in 1/2EV increments is exposed in the following order...

-1.0EV → -0.5EV → Normal → +0.5EV → +1.0EV

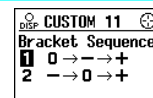

Custom 12 - Film Rewind Speed

1. **Fast Rewind**

Rewinds a 36-exposure roll in approximately 7 seconds.

2. **Slow (silent) Rewind**

Rewinds a 36-exposure roll in approximately 15.5 seconds.

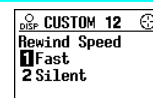

CUSTOM 13, 14, 15

Custom 13 - Metering Display Duration

- Selecting longer display durations reduces battery performance.

1. 5 seconds
2. 10 seconds
3. 30 seconds

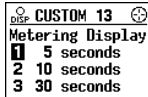

Custom 14 - AF Area Display

- Pressing the lens focus-hold button does not display the focus area LEDs.

- 1 - Focus area LEDs display the active focus area for 0.3 sec after the focus locks.
- 2 - Focus area LEDs display the active focus area for 0.6 sec after the focus locks.
- 3 - Focus area LED's don't display the active focus area by pressing the shutter-release button partway down.

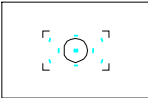

Focus area LEDs

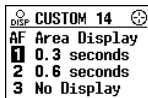

- Pressing the focus area selector or the spot AF button displays the active focus area.

To set custom functions;

1. Open control-panel door and press the CUSTOM button.
2. Turn the front control dial to select the desired custom function.
3. Turn the rear control dial to select the setting.
4. Press the shutter-release button partway down to enter the settings. Refer to pages 154-157 for additional information.

Custom 15 - Front and Rear Control Dial Lock

Use dial lock to prevent the settings from being changed by accidental turning of the dial while carrying the camera. If dials are locked, the settings cannot be changed by rotation of the front or rear control dials.

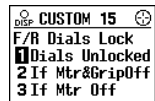

1. Off

- Front/rear control dials are functional.

2. Dials are not functional when the camera is not metering and the grip sensor is not activated.

- If metering (ie; the shutter speed and aperture appear) or if you grip the grip sensor, then the dials are functional.
- Front/rear control dials are functional for the operations which use buttons inside the control panel (eg; changing the date, reading stored data, custom functions, etc).
- If you turn the front/rear control dials when dials are locked this message appears.

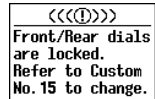

3. Dials are not functional only when not metering.

- Refer to above note for metering explanation.
- If metering is activated, dials are functional.

CUSTOM 16, 17, 18

Custom 16 - Release Lock (Lens)

1. Shutter cannot be released if a lens is not attached.

- [- -] appears when the shutter button is pressed partway down, and then this message appears when all the way down.

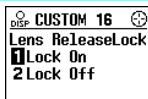

2. Shutter can be released if a lens is not attached.

- Use when mounting the lens to a non-coupling lens mount (telescope, microscope etc).

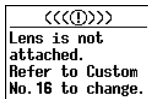

Custom 17 - AF Drive Speed

1 - Fast

- AF will operate at the maximum speed.

2 - Slow

- For use in close-up or low light conditions.

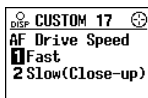

Custom 18 - Exposure Compensation Using the Rear Control Dial in P, A, and S Mode

You can compensate the exposure using the rear control dial. This is convenient when you are using a heavy lens and want to use your left hand to support it.

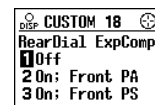

1. Default operation

Exposure compensation is not possible using the rear control dial.

Exposure Mode	Control Dial Tasking	
	Front Control Dial	Rear Control Dial
P - Mode	P _S - shutter speed	P _A - aperture
A - Mode	Aperture	Aperture
S - Mode	Shutter speed	Shutter speed

2. Exposure compensation using rear control dial (P_A - aperture in P mode)

In P/A/S mode, exposure compensation is possible using the rear control dial.

- If you turn the front control dial in P mode, you can select aperture.

Exposure Mode	Control Dial Tasking	
	Front Control Dial	Rear Control Dial
P - Mode	P _A - aperture	Exposure compensation
A - Mode	Aperture	Exposure compensation
S - Mode	Shutter speed	Exposure compensation

- The exposure compensation value is displayed in the meter index and the display.
- Exposure-compensation dial must be set to +/- 0.
- Compensation range is +/- 3 EV for both 1/2 and 1/3 EV increments.

CUSTOM 19, 20

3. Exposure compensation using rear control dial (Ps - shutter speed in P mode)

In P/A/S mode, exposure compensation is possible using the rear control dial.

- If you turn the front control dial in P mode, you can select the shutter speed.

Exposure Mode	Control Dial Tasking	
	Front Control Dial	Rear Control Dial
P - Mode	Ps - shutter speed	Exposure compensation
A - Mode	Aperture	
S - Mode	Shutter speed	

- Exposure compensation, using the rear control dial, is the same as for setting 2. Please refer to the notes in setting 2.

Custom 19 - Control Dial - Exchanged Control

This custom function allows you to switch the operations of the front and rear control dials.

1. Unchanged from Custom 18.

2. Front and rear control dial functions exchanged.

- Control dial tasking does not change for bracketing, data memory, and custom functions.

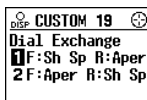

To set custom functions;

1. Open control-panel door and press the CUSTOM button.
2. Turn the front control dial to select the desired custom function.
3. Turn the rear control dial to select the setting.
4. Press the shutter-release button partway down to enter the settings. Refer to pages 154-157 for additional information.

Custom 20 - Flash Metering

Your camera uses ADI flash metering as the standard flash metering mode, but it can be changed.

- This applies to both the built-in and accessory flash.
- When full auto [P] is selected, if possible, flash metering is always ADI, even if Custom 20-2/3 is selected. If not possible, due to a flash/lens combination, TTL 4-segment flash will be used.

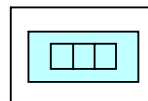
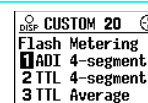

4-segment metering

1. ADI 4-segment

When flash fires, ADI 4-segment or pre-flash metering will be used.

- For more information see page 108.

2. TTL 4-segment

When flash fires, TTL 4-segment metering will be used.

- Recommend TTL 4-segment metering if using a flash/color meter, close-up diffuser, or filter.

3. TTL Average

When flash fires, TTL average metering will be used.

CUSTOM 21, 22

Custom 21 - AF Illuminator

In low-light/low subject contrast situations, the AF illuminator automatically projects a pattern of lines onto the subject for the camera's AF sensors to focus on.

- When full auto [P] is selected, the AF illuminator always fires, even if custom 21-2 is selected.

1. Fires if necessary.

2. Canceled

- Both the camera's and accessory flash's AF illuminator will not fire under any circumstance.
- Focusing may be difficult without AF illumination under low-light or low contrast conditions.

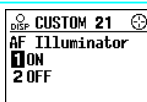

Custom 22 - Tasking on the Focus-Mode Switch - AF-A Position

The A (automatic autofocus) position on the focus-mode switch can be changed to DMF (direct manual focus) using this custom function.

- When full auto [P] is selected, this position is always automatic autofocus, even if Custom 22-2 is selected.

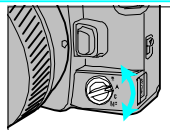

Focus-mode switch

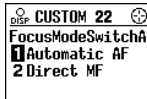

1. AF-A (Automatic autofocus) mode

Focus-mode switch positions:	
S	Single shot autofocus
A	Automatic autofocus
C	Continuous autofocus
M	Manual focus

2. DMF (Direct manual focus) mode

- After focus is confirmed, you can manually adjust the focus by turning the focusing ring.

Focus-mode switch positions:	
S	Single shot autofocus
A	Direct manual focus
C	Continuous autofocus
M	Manual focus

How to use DMF

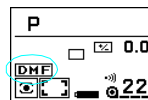

1. Set custom 22 to 2.

2. Turn the focus-mode switch to A.

- [DMF] appears in the display.

3. Press the shutter-release button partway down to focus.

- [MF] glows and [MF] appears in the viewfinder.
- DMF can also be selected when focusing by pressing the focus area selector or the AF/MF control button.

4. While pressing the shutter-release button, turn the lens focusing ring to adjust focus.

5. Press the shutter-release button all the way down to take the picture.

- If you remove your finger from the shutter-release button, autofocus will be activated again when the shutter-release button is pressed partway down.
- To cancel DMF, turn the focus-mode switch to a position other than A.
- DMF is not possible with xi series lenses and the AF power zoom lens.

CUSTOM 23, 24, 25

Custom 23 - AF Using Shutter-Release Button

1. AF works when you press the shutter-release button partway down.

- AF does not work when MF is selected.
- When full auto  is selected, AF works when you press the shutter-release button partway down, even if Custom 23-2 is selected.

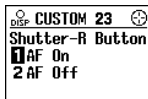

2. AF does not work when you press the shutter-release button partway down.

- Press the focus-area selector or the spot-AF button to activate AF.

Custom 24 - Full-Auto mode of the Exposure-Mode Dial

1. When the exposure mode is set to , full-auto, changes to camera functions are not possible.

- See page 26 for the full-auto settings.

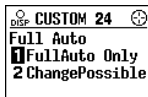

2. Even after selecting , changes are acceptable.

- When Custom 24-2 is selected, "Full Auto" will not appear in the display.
- Auto-flash is not possible.
- Flash always fires if the built-in flash is up, or the accessory flash is on.
- When the main switch is turned off, the additional changes will be cancelled.
- Custom 1, 20, 21, 22, and 23 settings are effective.

To set custom functions;

1. Open control-panel door and press the CUSTOM button.
2. Turn the front control dial to select the desired custom function.
3. Turn the rear control dial to select the setting.
4. Press the shutter-release button partway down to enter the settings. Refer to pages 154-157 for additional information.

Custom 25 - Tasking on Exposure-mode Dial - Position 3

The exposure-mode dial has 3 memory positions. You can choose to have position 3 used for the STF mode.

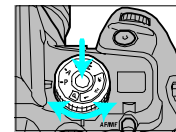

1. Memory mode

This setting uses position 3 for memory.

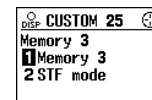

CUSTOM 25, 26

2. STF mode

- Beautifully defocused images can be produced using the STF (Smooth Trans Focus) mode. The images are reproduced faithfully as to shape, with softened edges.



Effect using STF



STF not used

- Because your camera's STF mode triggers a continuous multiple exposure, it should only be used with a tripod and a still subject.



- Set Custom 25-2.
- Turn the exposure-mode dial to 3.
 - STF appears in the display.
- Press the shutter release button all the way down to take the picture.
 - 7 exposures occur.
 - To cancel STF mode, turn the exposure-mode dial to a position other than 3, or set Custom 25-1.
 - Shutter speed and aperture will be set automatically.
 - Flash doesn't fire.
 - Exposure compensation is possible.

To set custom functions;

- Open control-panel door and press the CUSTOM button.
- Turn the front control dial to select the desired custom function.
- Turn the rear control dial to select the setting.
- Press the shutter-release button partway down to enter the settings. Refer to pages 154-157 for additional information.

- When in STF mode, aperture will be displayed in T-numbers, not f-numbers. T-numbers are practical aperture values which take into account the f-number as well as the light lost by absorption in the optical system. In this case, it indicates the aperture of a single exposure. Use in place of f-numbers for determining exposure.
- When the subject is bright, STF is not possible. The aperture's background will appear white.
- If you use the 135mm f/2.8 [T4.5], you can get a STF effect with a single exposure. In this case, don't use Custom 25-2.
- STF mode is not possible if you are using the AF Reflex 500mm f/8.



CUSTOM FUNCTIONS

Custom 26 - Flash Burst with Exposure Compensation

You can control the flash burst when exposure compensation is selected.

- This applies only for exposure compensation, and not for flash compensation. Please refer to page 80 for explanation of the difference.

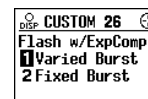

CUSTOM 26, 27

1. Varied burst

When the flash fires and exposure compensation is set, both the flash burst and the aperture and shutter-speed change to compensate the exposure.

- Exposure compensation is done for subjects both in and outside the flash range area.

2. Fixed burst

When the flash fires and exposure compensation is set, only the aperture/shutter-speed change to compensate the exposure. The flash burst is fixed. Exposure within the flash range remains almost the same.

Custom 27 - Detailed Display

1. Show all settings.

Select this setting if you want all the settings to be shown in the display.

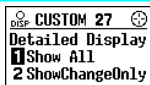

2. Show only the changes from the standard settings.

Use this setting when you feel that the display is too crowded with all settings shown.

- The standard settings will not be shown, only those that have been changed.
- The standard settings are shown on the next page.

182

To set custom functions;

1. Open control-panel door and press the CUSTOM button.
2. Turn the front control dial to select the desired custom function.
3. Turn the rear control dial to select the setting.
4. Press the shutter-release button partway down to enter the settings. Refer to pages 154-157 for additional information.

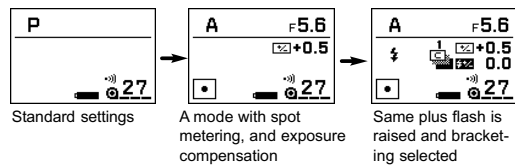

Standard settings

A mode with spot metering, and exposure compensation

Same plus flash is raised and bracketing selected

- When Custom 27-2 is selected, an exposure compensation of 0.0 will not appear in the large icon display.
- The exposure-mode indicator and battery-condition indicator appear all the time.

The camera's standard settings are shown in the chart below.

Item	Standard Settings
Focus	AF-A (Autofocus priority)
Focus area	Wide focus area
Metering	14 Segment honeycomb
Exposure compensation	+/- 0
Flash compensation	+/- 0
Drive	Single frame advance

CUSTOM FUNCTIONS

183

CUSTOM 28, 29, 30, 31

Custom 28 - Operation Display

The operation display appears whenever a camera dial or function is operated that is not already on the display. The new settings remain displayed for 5 seconds. See page 42 for more information.

1. On
2. Off

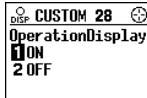
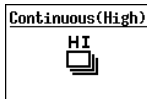

Custom 29 - Large Icon Display

For easier viewing of only a few items, the large-icon display can be selected by pressing the display-selection button. See page 39 for more information.

1. On
2. Off

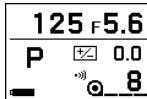

To set custom functions;

1. Open control-panel door and press the CUSTOM button.
2. Turn the front control dial to select the desired custom function.
3. Turn the rear control dial to select the setting.
4. Press the shutter-release button partway down to enter the settings. Refer to pages 154-157 for additional information.

Custom 30 - Meter Index Display

The meter index displays the values of compensation and bracketing that you have selected. Select Custom 30-2, if you want to have it shown only in the viewfinder. See page 40 for more information.

1. On
 - Meter index will be shown in both the viewfinder and the navigation display.
2. Off
 - Meter index will only be shown in the viewfinder.



Custom 31 - Exposure History Display

When the display-selection button is pressed, the exposure data for the next frame appears in the upper part of the display, followed by those of the last 5 frames below it. See page 41 for more information.

1. On
2. Off

8	125	5.6	0.0
7	500	2.8	0.0
6	750	4	-0.5
5	250	5.6	0.0
4	60	5.6	+1.5
3	2000	5.6	-2.0

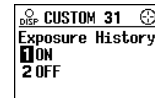

CUSTOM, 32, 33, 34, 35

Custom 32 - Vertical Display

1. On

The navigation display automatically changes orientation, depending on whether the camera is in a horizontal or vertical position.

- The change occurs when the shutter-release button is pressed partway down.

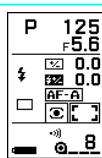

Vertical display

2. Off

The display remains in the horizontal orientation, regardless of the camera's position.

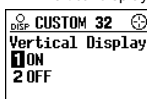

Custom 33 - Imprint Intensity

You can adjust the imprint intensity for the date/time. Turn the rear control dial to set the desired imprint intensity level.

- If the ISO is lower than 100 or higher than 800, all of the intensity settings are not always effective.

1 to 7

- 1 - 3 Low intensity
- 4 Standard
- 5 - 7 High intensity

0

When 0 is selected, the printing is off.

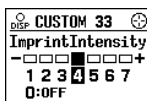

To set custom functions;

1. Open control-panel door and press the CUSTOM button.
2. Turn the front control dial to select the desired custom function.
3. Turn the rear control dial to select the setting.
4. Press the shutter-release button partway down to enter the settings. Refer to pages 154-157 for additional information.

Custom 34 - Camera's ID Number

The data number starts at dn1-0001 and increases each time another roll of film is loaded. This custom function allows you to change the 3rd character (ie; the 1 in "dn1") to be used to identify an individual camera body.

Turn the rear control dial to select number 1 to 9.

- Whenever the ID number is changed, the change takes effect when the next roll of film is loaded.

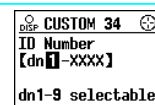

Custom 35 - Language

The navigation display is capable of giving information in any one of the following five languages.

1. Japanese
2. English (Eng)
3. German (Deu)
4. French (Fra)
5. Spanish (Esp)



order manuals online at: realeasybay.com/manuals

APPENDIX

ACCESSORY INFORMATION

The information in this manual is relevant for products introduced before August 2000. Contact the nearest authorized Minolta Service Facility to obtain information for products released after this date.

Lenses

- All Minolta AF lenses can be used with this camera.
- MD and MC series lenses (manual focus) cannot be used with this camera.
- "D lens" in this manual indicate the lenses whose name include "D".

Flash Units

- All Minolta i, si, and HS series flash units, and the Vectis SF-1 flash, are compatible with this camera.
- The Flash Shoe Adapter FS-1100 is required to mount AF series flash units (4000AF, 2800AF, 1800AF, and Macro flash 1200AF).
- The AF illuminator will not activate when the FS-1100 is attached.
- X-series flashes cannot be used with this camera.
- "D flash" in this manual indicate the flashes whose name include "D".



Vertical Control Grip VC-7

The Vertical Control Grip VC-7 offers the same comfort and security as when the camera is operated horizontally. It has duplicate controls (shutter-release button, control dials, grip switch, etc.) for improved vertical operation. There are three battery types to choose from for extended shooting sessions.

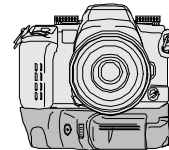

APPENDIX

ACCESSORY INFORMATION

Data Saver DS-100

Using the camera's data memory mode, photographic data for 400~1900 rolls of film can be saved on 3.3v 2-32 MB Smart Media card. The saved data can be viewed on the camera's navigation panel or accessed by a PC.

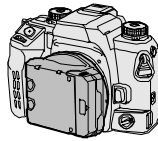

Focusing Screen 7 II

Four focusing screens can be used with your camera.

Designed for users of large aperture lenses, the M type screen uses the super spherical acute matte surface for greater light dispersion and sharper focus control.

- The edges of the viewfinder may appear dark when some telephoto lenses are used with the type G, S, and L focusing screens. The final image will not be affected.
- Screens can only be changed at an authorized Minolta Service Facility.

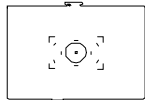

Type G/M

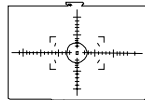

Type S

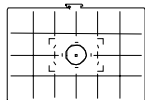

Type L/ML

Remote Cord

Attach either Remote Cord RC-1000S or RC-1000L to reduce blur when taking long exposures.

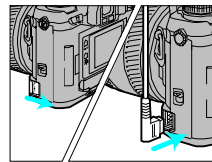

1. Slide the remote-control terminal cover open.
2. Insert the plug into the terminal.

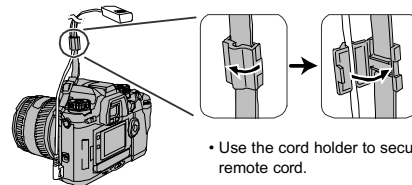

- Use the cord holder to secure the remote cord.

Others

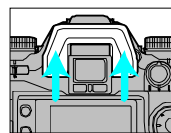

- Remove the eyepiece cup, when attaching a finder accessory (AngleFinder, etc).
- Push up to remove the eyepiece cup.

The following accessories are not compatible with this camera:

- Control Grip CG-1000
- Data Receiver DR-1000

TROUBLE SHOOTING (DISPLAY)

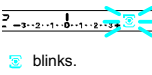
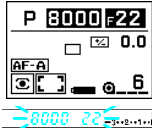
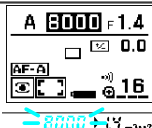
Display	Cause	Solution
 <p>Upper part of display turns black</p>	When full-auto [P] or one of the memory positions is selected, the position of the controls may not match the camera settings.	Take picture using the information presented in the navigation display.
 <p>Scene or subject brightness is beyond the camera's metering range.</p>	Scene or subject brightness is beyond the camera's metering range.	Bright Light Use slower speed film, a neutral density (ND) filter, or reduce the light level of your surroundings.
 <p>Shutter speed and aperture turns black or blinks.</p>	Light level is beyond the range of available shutter speeds and apertures.	Low Light Use higher speed film or a flash.
 <p>Shutter speed turns black or blinks.</p>	The required shutter speed is beyond the range of the camera (A mode only)	Select a larger or smaller aperture until the display returns to normal.

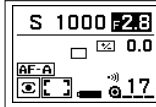
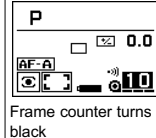
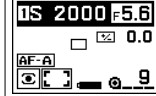
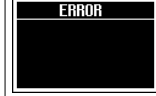
Display	Cause	Solution
 <p>Aperture turns black or blinks.</p>	The required aperture is beyond the range of the lens. (S mode only)	Select a faster or slower shutter speed until the display returns to normal.
 <p>Frame counter turns black</p>	This indicates that a multiple exposure is about to be made. Either multiple exposure has been selected by the drive mode lever, or the film has been partially rewound using the select-frame film transport function.	
 <p>A combination of causes has occurred.</p>	A combination of causes has occurred.	
	Remove and reinstall the batteries. If normal camera operation does not resume or the camera malfunctions repeatedly, contact an authorized Minolta Service Facility.	

order manuals online at: realeasybay.com/manuals

TROUBLE SHOOTING (OTHERS)

Problem	Cause	Solution	Page
No display appears when camera is switched on	Batteries are loaded incorrectly or exhausted.	Remove and reinstall the batteries, or install new batteries.	17
Autofocus does not work when shutter-release button is pressed partway down.	Situation is unsuitable for autofocus.	Use focus lock or manual focus.	29/ 48
	Camera is set to manual focus mode.	Turn the focus-mode switch to AF.	46
	Subject is too close.	Check the minimum focus distance for your lens.	–
Shutter cannot be released.	Custom 23 set to setting 2.	Set Custom 23 to setting 1.	178
	Focus cannot be confirmed.	Use focus lock or manual focus.	29/ 48
	Camera is attached to a microscope or telescope.	Set Custom 16 to setting 2.	172
Picture is blurred.	Flash didn't fire and shutter speed was slow.	Use flash or a tripod.	–
	Custom Function 5 set to setting 2.	Set Custom 5 to setting 1.	164

194

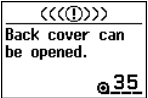
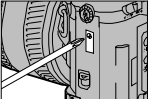
Problem	Cause	Solution	Page
Flash picture is too dark	Subject is beyond flash range	Make sure the subject is within the flash range.	32
Lower part of the flash picture is dark	Lens hood attached	Remove lens hood. The distance between the subject and the camera must be at least 1m (3.3ft.) when the built-in flash is used.	–
Cannot open the back cover to remove the film.	<p>This camera has a safety-lock feature and you cannot open the back-cover when film is loaded. In case of trouble, it can be opened by following these steps.</p> <ol style="list-style-type: none"> 1. Turn the main switch to OFF. 2. While pressing the ISO and AE-lock buttons, turn the main switch to ON. 3. This message will appear and the back-cover can now be opened. <p>If you change your mind and don't want to open the back-cover, repeat steps 1 and 2. No message will appear and you can continue to take pictures.</p> <p>If the back cover still won't open,</p> <ol style="list-style-type: none"> 1. Remove the screw and small panel, located below the PC terminal. 2. Place the camera in a dark (light tight) box. 3. Slide the inside lever down to open the cover. 		 

APPENDIX

195

order manuals online at: realeasybay.com/manuals

CARE AND STORAGE

Operating Temperature and Conditions

- This camera is designed for use from -20 to 50 °C (4 to 122 °F).
- Never leave your camera where it may be subjected to extreme temperatures such as the glove compartment of a car.
- Data panel response time will be slow at colder temperatures. The display will temporarily darken at higher temperatures, but will restore when the temperature normalizes.
- This camera is not waterproof or splashproof. When using the camera in the rain, protect the camera and the lens.
- Never subject the camera to extreme humidity.
- To prevent condensation from forming, place the camera in a sealed plastic bag when bringing it from cold environment to a warm environment. Allow it to come to room temperature before removing it from the bag.
- A low-battery indicator may appear even with fresh batteries depending on the storage conditions. To restore camera power, repeat turning the camera on and off.
- Battery capacity decreases at colder temperatures. A half or low-battery indicator may appear even with fresh batteries, so keep your camera and spare batteries in a warm inside pocket when shooting in cold weather. Batteries will regain some of their capacity when warmed to normal operating temperature.

Before Important Events

- Check the camera's operation carefully, or take test photographs.
- Minolta is not responsible for any loss that may occur due to an equipment malfunction.

196

Cleaning

- If the camera or lens barrel is dirty, wipe it gently with a soft, clean, dry cloth. If the camera or lens comes in contact with sand, gently blow away loose particles - wiping may scratch the surface.
- To clean the lens surface, first brush away any dust or sand then, if necessary, moisten a lens tissue with lens cleaning fluid and gently wipe the lens in a circular motion, starting from the center.
- Never place lens fluid directly on the lens.
- Never touch the interior of the camera, especially the shutter and mirror, doing so may impair their alignment and movement.
- Dust on the mirror will not affect the exposure but may affect the focus. Use a blower brush to remove dust from or around the mirror.
- Never use compressed air to clean the camera's interior, it may cause damage to sensitive interior parts.
- Never use organic solvents to clean the camera.
- Never touch the lens surface with your fingers.

Storage

When storing your camera for extended periods,

- Always attach the protective caps.
- Store in a cool, dry, and well-ventilated area away from dust and chemicals such as moth balls. For long periods, place the camera in an airtight container with a silica gel drying agent.
- Periodically release the camera's shutter to keep it operating properly.
- Before using after prolonged storage, check the camera's operation to make sure it is functioning properly.

Questions and Service

- If you have questions about your camera, contact your local camera dealer or write to the Minolta distributor in your area.
- Before shipping your camera for repair, please contact an authorized Minolta Service Facility for details.

197

order manuals online at: realeasybay.com/manuals

SPECIFICATIONS

Camera Type: 35mm SLR with built-in flash, autoexposure (AE)

Focus Type: 9 point TTL phase-detection system, multi metering with dual cross-hair type CCD line sensor metering cell. Multi-dimensional predictive focus control is available for moving subjects.

AF Sensitivity Range: EV -1 to 18 (ISO 100)

AF Illuminator: Built-in LED. Automatically activated in low-light/ low-contrast situations. Range: 0.7 - 7m (With a standard 50mm lens.)

AF Control: Single-shot, continuous, automatic AF-mode selection. DMF mode is possible.

Exposure Modes: P, A, S, M (PA/Ps available)

Type: TTL metering; direct TTL metering for flash

Metering Cell: 14-segment honeycomb-pattern SPC, 4-segment flash-metering SPC for flash

Metering Range : 14-segment metering: EV 0 - 20, Center weighted average: EV 0 - 20, Spot metering: EV 3 - 20

Film-speed Setting: Automatic: ISO 25 to 5000 for DX-coded film. Manual: ISO 6 to 6400 in 1/3 EV increments. Flash: ISO 25 - 1000.

Shutter Type: Electronically-controlled, vertical-traverse, focal-plane type

Speeds: 30 sec. - 1/8000 sec., bulb (approximately 7 hours with fresh batteries).

Flash sync speed: 1/200 or slower (synchronizes with all speeds in HSS mode).

Built-in Flash GN: 12 (ISO 100 in meters)

Coverage: 24mm angle of view

Recycling Time: Approx. 2 sec. (3.5 sec when red-eye reduction or wireless/remote flash is used) - (according to Minolta test methods)

Modes: Fill-flash, Fill-flash with red-eye reduction, Flash Cancel, Wireless flash, Slow-sync, and Rear-flash sync., Autoflash when full-auto is set.

Viewfinder Type: Eye level fixed pentaprism

Field of view: Approx. 92% x 94% (with 50mm f/1.4 at ∞)

Magnification: 0.8X (with 50mm lens f/1.4 at ∞)

Focusing Screen: Spherical acute matte

Eye-Relief: 22.5 mm from the eyepiece, 18.5 mm from the eyepiece frame.

Diopter: -1 diopter, Adjustment: -2.5 - +0.5

Film Transport Drive Modes: Single frame advance, Continuous advance (Low 2 frames/sec., High 4 frames/sec, 3.7 in AF mode), Self-timer (10 or 2 second), Exposure bracketing (single-frame or continuous advance), Multiple exposure. Auto load

Loading: Auto load

Rewind: Auto rewind, manual start
Rewind time (24 exposure film): High speed: 5.5 sec., Silent: 12 sec.

order manuals online at: realeasybay.com/manuals

SPECIFICATIONS

Additional

Power: Two CR123A lithium batteries

Battery Performance:

Flash Use (%)	24 Exposure Rolls		36 Exposure Rolls	
	20 °C	-20 °C	20 °C	-20 °C
0	45 rolls	13 rolls	30 rolls	9 rolls
50	21 rolls	6 rolls	14 rolls	4 rolls
100	13 rolls	4 rolls	9 rolls	2 rolls

Test Conditions : Lens (24-85 f/3.5-4.5) is focused from infinity to 2m three times and the shutter-release button held partway down for ten seconds before each exposure.

- Battery performance will vary with usage conditions.
- Exposures taken at a rate of 3 rolls/month for 24 exposure rolls, 2 rolls/month for 36 exposure rolls (starting with fresh batteries).

Dimensions (WxHxD): 143.5 x 97.5 x 65.5mm (WxHxD)

Weight : 575g (w/o camera battery)

Specifications are based on the latest information available at the time of printing and are subject to change without notice.

This device complies with Part 15 of the FCC Rules. Operation is subject to the following two conditions: (1) This device may not cause harmful interference, and (2) this device must accept any interference received, including interference that may cause undesired operation. Changes or modifications not approved by the party responsible for compliance could void the user's authority to operate the equipment. This equipment has been tested and found to comply with the limits for a Class B digital device, pursuant to Part 15 of the FCC Rules. These limits are designed to provide reasonable protection against harmful interference in a residential installation. This equipment generates, uses and can radiate radio frequency energy and, if not installed and used in accordance with the instructions, may cause harmful interference to radio communications. However, there is no guarantee that interference will not occur in a particular installation. If this equipment does cause harmful interference to radio or television reception, which can be determined by turning the equipment off and on, the user is encouraged to try to correct the interference by one or more of the following measures:

- Reorient or relocate the receiving antenna.
- Increase the separation between the equipment and the receiver.
- Connect the equipment to an outlet on a circuit different from that to which the receiver is connected.
- Consult the dealer or an experienced radio/TV technician for help.

This Class B digital apparatus complies with Canadian ICES-003.



This mark on the bottom of your camera is there to inform you that this camera meets the requirements of the EU (European Union) concerning interference causing equipment regulations. CE stands for Conformit  europ enne (European Conformity).

APPENDIX

order manuals online at: realeasybay.com/manuals

INDEX

Subject	Page No.
Accessory flash	107
ADI flash metering	98
AF illuminator	59
AF/MF control button.....	50
Audio	131
Automatic autofocus (A).....	46
Automatic exposure lock (AEL).....	81
Batteries	17
Brightness distribution display.....	85
Continuous advance drive mode.....	88
Continuous autofocus (C).....	47
Custom functions	153-187
Display illumination.....	44
Display contrast.....	44
Data memory.....	140-152
Data saver DS-100.....	190
Diopter adjustment	130
Depth-of-field preview	128
Detailed display	39
Display - When upper part turns black.....	43
Exposure bracketing	92-95
Exposure compensation.....	77-80
Exposure history display	41
Exposure modes	60-69
Eye-start	125
Focus lock	29
Film - loading.....	20-22
Film - rewinding.....	33-34
Flash bracketing.....	104-106
Flash - built-in.....	31
Flash compensation	103
Flash metering.....	108
Flash - PC terminal.....	118

202

Subject	Page No.
Flash range	32
Flash units compatibility	189
Focus areas	53-58
Focus signals	28
Full auto mode	24-27
High-speed sync.....	110
ISO - manually set.....	86
Large icon display	39
Lens - attaching/removing.....	19
Manual focus	48
Manual shift	72
Memory	132-139
Meter index display	40
Metering methods	74-76
Multiple exposure	96
Navigation display	36
Operation display	42
Pre-flash metering	108
Rear-flash sync	101
Red-eye reduction	100
Remote cord.....	191
Select-frame film transport	161
Self-timer	90
Single-shot autofocus.....	47-48
Slow-shutter sync	102
Special focus situations.....	30
STF mode.....	180
Strap - attaching	16
Time exposures (bulb)	126-127
TTL metering	108
Vertical control grip.....	189
Wireless/Remote Off-camera flash.....	112-118
Vertical display	42

203

APPENDIX