

E INSTRUCTION MANUAL

DYNAX™
MAXXUM®
800si



MINOLTA

BASIC
OPERATION

FOCUS
BASICS

FLASH
BASICS

SUBJECT
PROGRAM
MODES

EXPOSURE
BASICS

ADVANCED
AUTOFOCUS

ADVANCED
EXPOSURE

ADVANCED
FLASH

ADDITIONAL
FEATURES

APPENDIX

FOR PROPER AND SAFE USE

Thank you for purchasing the Minolta Dynax/Maxxum 800si. The 800si features Minolta's highly acclaimed 14-Segment Honeycomb Pattern Metering, a built-in high-power zoom flash, and built-in Intelligent Card functions. The built-in flash covers focal lengths from 24 to 80mm and has a guide number of up to 20. A screw-type PC terminal and Rear-flash sync function give you maximum control over flash exposures.

The High-Speed Autofocus, Predictive Focus Control functions, and top shutter speed of 1/8000 second mean the 800si responds quickly, accurately, and flexibly to virtually any motion, composition, or lighting condition in the moment of a shutter release.

The 800si also offers full control over all camera systems. In addition, you can select any of the four local focus areas, take spot meter readings, lock exposure and focus separately or together, and use Memory to save and later recall three groups of your most often used camera settings.

This manual has been designed to help you understand the operation of your camera and its functions. Please familiarize yourself with the names of the controls and their locations on the camera, then read this manual thoroughly.

 This mark on your camera certifies that this camera meets the requirements of the EU (European Union) concerning interference causing equipment regulations. CE stands for Conformité Européenne (European Conformity).

This device complies with Part 15 of the FCC Rules. Operation is subject to the following two conditions: (1) This device may not cause harmful interference, and (2) this device must accept any interference received, including interference that may cause undesired operation. Changes or modifications not approved by the party responsible for compliance could void the user's authority to operate the equipment. This equipment has been tested and found to comply with the limits for a Class B digital device, pursuant to Part 15 of the FCC Rules. These limits are designed to provide reasonable protection against harmful interference in a residential installation. This equipment generates, uses and can radiate radio frequency energy and, if not installed and used in accordance with the instructions, may cause harmful interference to radio communications. However, there is no guarantee that interference will not occur in a particular installation. If this equipment does cause harmful interference to radio or television reception, which can be determined by turning the equipment off and on, the user is encouraged to try to correct the interference by one or more of the following measures:

- Reorient or relocate the receiving antenna.
- Increase the separation between the equipment and the receiver.
- Connect the equipment to an outlet on a circuit different from that to which the receiver is connected.
- Consult the dealer or an experienced radio/TV technician for help.

This Class B digital apparatus meets all requirements of the Canadian Interference-Causing Equipment Regulations.

Read and understand all warnings and cautions before using this product.

WARNING

Batteries may become hot or explode due to improper use.

- Use only the batteries specified in this instruction manual.
- Do not install the batteries with the polarity (+/-) reversed.
- Do not subject batteries to fire or high temperatures.
- Do not attempt to recharge, short, or disassemble.

Use caution, accidents may occur when using this product near young children.

Keep batteries or things that could be swallowed away from young children. Contact a doctor immediately if an object is swallowed.

Immediately remove the batteries and discontinue use if...

- the camera is dropped or subjected to an impact in which the interior is exposed.
- the product emits a strange smell, heat, or smoke.

Do not disassemble. Electric shock may occur if a high voltage circuit inside the camera is touched. Take your camera to a Minolta Service Facility when repairs are required.

Do not look directly at the sun through the viewfinder.

Fire may occur if the camera is subjected to focused sunlight. Replace the lens cap when the product is not being used.

TABLE OF CONTENTS

	For Proper and Safe Use.....1	Names of Parts.....4	Quick Operation8
BASIC OPERATION	Standard Accessories11 Installing the Batteries12 Battery Condition Indicators.....13 Attaching and Removing the Lens.....14	Loading the Film.....16 Handling the Camera18 Diopter Adjustment19	Eye-Start.....20 Shooting in Full-Auto Mode.....22 Rewinding the Film.....24
FOCUS BASICS	Focus Signals26 Focus Lock27	Special Focusing Situations30 Manual Focus.....31	AF Illuminator32
FLASH BASICS	Using the Built-in Flash.....34 Flash Signals35	Flash Range36 Red-Eye Reduction38	Fill Flash39
SUBJECT PROGRAM MODES	Subject Program Selection41 Portrait Mode42	Landscape Mode43 Close-up Mode44	Sports Mode45 Night Portrait Mode46
EXPOSURE BASICS	Exposure Modes.....49 P: Programmed Autoexposure Mode51	A: Aperture Priority Mode53 S: Shutter Priority Mode56	M: Manual Exposure Mode59 Bulb62
ADVANCED AUTOFOCUS	Autofocus Modes64 Changing the Autofocus Mode66	Focus Frame67 Wide Focus Area67	Local Focus Area.....68 Release Priority69
ADVANCED EXPOSURE	Metering71 Selecting a Metering Method.....73 Exposure Compensation74	AE Lock75 Exposure Bracketing77 Flash Bracketing.....79	Multiple Exposure81 Metering Index.....84
ADVANCED FLASH	High-speed Flash Sync.....87 Slow-shutter Sync.....88 Rear-flash Sync89	Flash Compensation91 Wireless/Remote Off-camera Flash Control92	PC Terminal.....97
ADDITIONAL FEATURES	Memory99 Customized Settings.....102 Data Memory106	For Owners of the Quartz Date Model.....112 Depth-of-Field Preview.....114	Setting Film Speed Manually115 Self-timer117 Film-drive Modes.....118
APPENDIX	Program-reset button120 Accessory Information121	Troubleshooting.....123 Care and Storage126	Technical Details129

NAMES OF PARTS

For information on specific parts, refer to the page numbers shown in parenthesis.

BODY

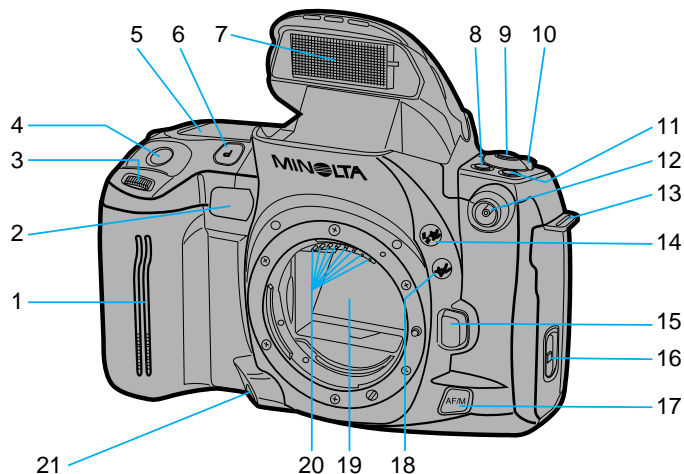

- | | |
|---|---|
| 1. Grip sensor (20) | 12. PC terminal (97) |
| 2. AF illuminator/Self-timer lamp (32, 117) | 13. Strap eyelet (11) |
| 3. Front control dial | 14. Flash-compensation button (91) |
| 4. Shutter-release button | 15. Lens release (14-15) |
| 5. Data panel (6) | 16. Back-cover release (16) |
| 6. Program-reset button (9, 120) | 17. Focus-mode button (31) |
| 7. Built-in flash (34-39) | 18. Exposure-compensation button (74) |
| 8. Subject program button (41-47) | 19. Mirror* |
| 9. Memory-recall button (101) | 20. Lens contacts* |
| 10. Memory-number lever (100) | 21. Depth-of-field preview button (114) |
| 11. Exposure-mode button (50) | |

* Do not touch.

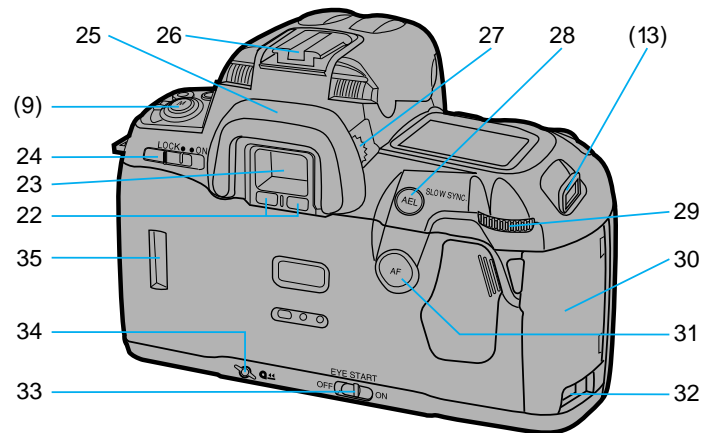

- | | |
|------------------------------------|----------------------------------|
| 22. Eyepiece sensor* (20) | 29. Rear control dial |
| 23. Viewfinder* | 30. Control panel door |
| 24. Main switch | 31. AF button (28-29, 68) |
| 25. Eyepiece cup (11) | 32. Remote-control terminal (62) |
| 26. Accessory shoe | 33. Eye-start switch (21) |
| 27. Diopter-adjustment dial (19) | 34. Rewind button (24) |
| 28. AE-lock button (75-76, 88, 95) | 35. Film window (16) |

CONTROL PANEL

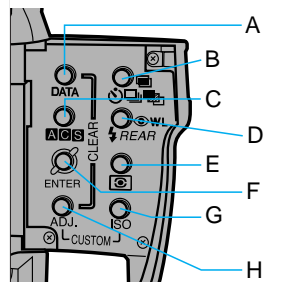

- | |
|---|
| A. Data-memory button (108, 111) |
| B. Self-timer/drive-mode button (77-83, 117, 118) |
| C. AF-mode button (66) |
| D. Flash-mode button (38, 89, 92-96) |
| E. Metering-mode button (73) |
| F. Enter button (100) |
| G. ISO button (115) |
| H. Adjust button (69, 77, 81, 104-105, 109-111) |

NAMES OF PARTS

DATA PANEL

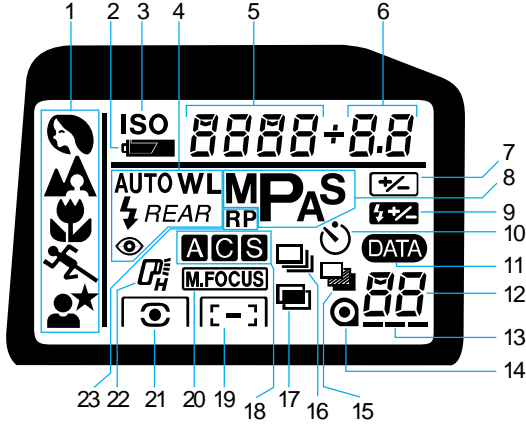

- | | |
|--|-----------------------------------|
| 1. Subject Program Selection icons | 11. Data-memory indicator |
| 2. Battery-condition indicator | 12. Frame counter |
| 3. Film-speed mark | 13. Film-transport signal |
| 4. Flash-mode indicators | 14. Film-cartridge mark |
| 5. Shutter-speed/Film-speed/Focus-area display | 15. Exposure-bracketing indicator |
| 6. Aperture/Exposure-compensation/Flash-compensation display | 16. Drive-mode indicator |
| 7. Exposure-compensation indicator | 17. Multiple-exposure indicator |
| 8. Exposure-mode indicator | 18. AF-mode indicator |
| 9. Flash-compensation display | 19. Focus-area indicator |
| 10. Self-timer indicator | 20. Manual-focus indicator |
| | 21. Metering-mode indicator |
| | 22. High-speed sync indicator |
| | 23. Release-priority indicator |

VIEWFINDER

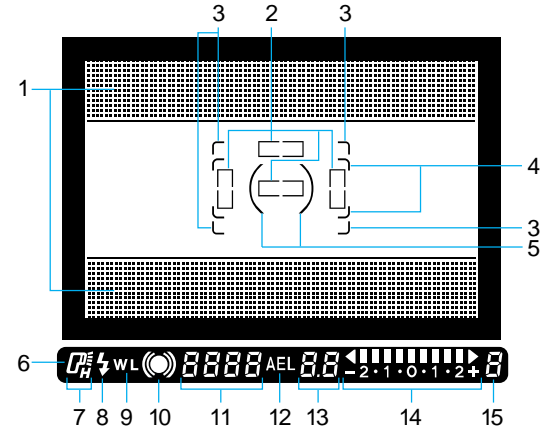

- | | |
|------------------------------------|---|
| 1. Panorama frame | 10. Focus signals |
| 2. Local-focus areas | 11. Shutter-speed/Focus-area display |
| 3. Horizontal wide-focus frame | 12. AEL indicator |
| 4. Vertical wide-focus frame | 13. Aperture/Exposure-compensation/Flash-compensation display |
| 5. Spot-metering area | 14. Metering index |
| 6. Flash-on indicator | 15. Frame counter |
| 7. High-speed sync flash indicator | |
| 8. Flash signals | |
| 9. Wireless-flash indicator | |

QUICK OPERATION

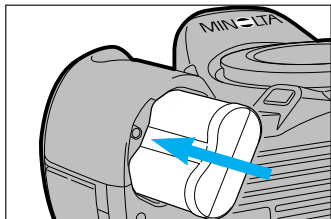

- 1** Insert the batteries.
- The camera uses one 2CR5 cell.

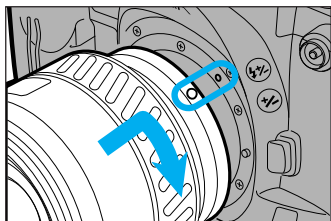

- 2** Attach a lens.
- Align the red marks, then turn it gently clockwise until it clicks.

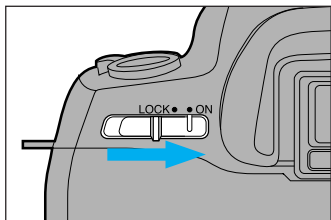

- 3** Turn the camera on.
- Set the main switch to ON.

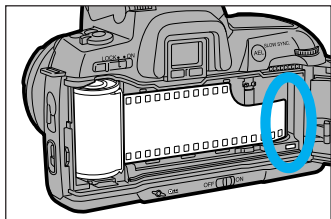

- 4** Load the film.
- Line the film-tip with the red mark, then close the back cover.

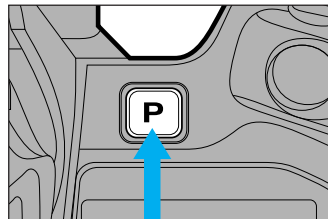

- 5** Set the camera to full-auto operation.
- Press the program-reset button.

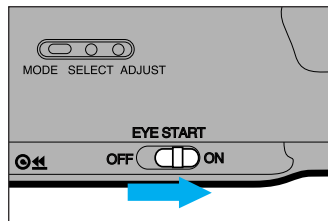

- 6** Turn eye-start on.

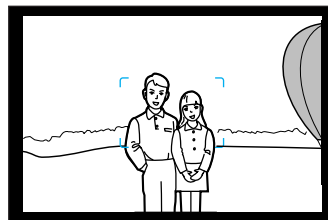

- 7** Frame the picture.
- Align your subject in the focus frame and the camera will automatically focus.

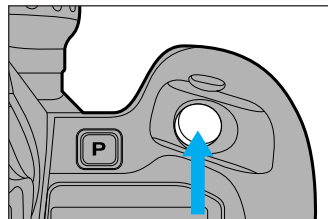

- 8** Take the picture.
- Gently press the shutter release button all the way down.

BASIC OPERATION

STANDARD ACCESSORIES

NECKSTRAP

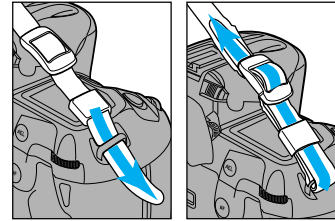

Attach the neckstrap as shown.

EYEPIECE CUP

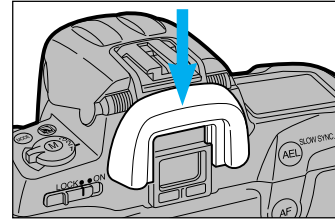

Attach the eyepiece cup as shown.

EYEPIECE AND ACCESSORY SHOE CAPS

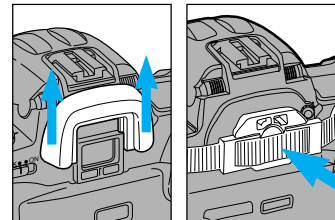

An eyepiece cap is attached to the strap. Before using the self-timer or making long exposures, remove the the eyepiece cup and attach the cap to the viewfinder eyepiece to prevent stray light from entering the camera and affecting exposure.

The camera also comes with an accessory-shoe cap which protects the accessory-shoe contacts. When using a flash or other accessory, slide the accessory-shoe cap into the eyepiece cap for safekeeping.

INSTALLING THE BATTERIES

Your camera uses one 6-volt 2CR5 battery to supply power for all camera operations. Please read all warnings in the For Proper and Safe Use section of this manual, as well as warnings supplied by the battery manufacturer.

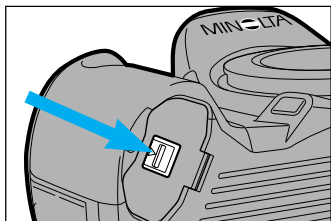

- 1** Set the main switch to LOCK. Slide the battery-cover release in the direction indicated to open the cover.

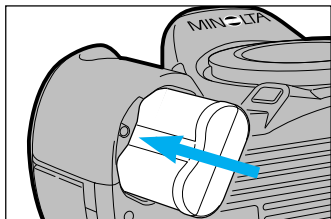

- 2** Insert the battery according to the marks on the inside of the chamber cover. Snap the cover closed.

BATTERY CONDITION INDICATORS

A battery-condition indicator will appear in the data panel for 5 seconds each time the camera is turned on. This mark signifies the power status of the battery.

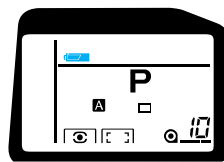

Full-battery symbol:

Power is sufficient for all camera operations.

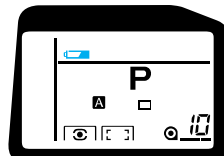

Low-battery symbol:

Power is low, but all functions are operational. Keep a fresh battery ready.

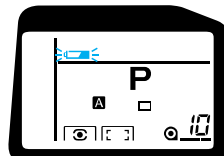

Blinking low-battery symbol:

Power is extremely low. The battery will need to be replaced very soon.

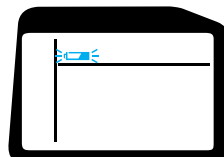

Blinking low-battery symbol only:

Power is too low for normal camera operations. Replace the battery.

- This indicator will appear even while the main switch is set to LOCK.

No display: Power is too low for any camera operations. Replace the battery or check that it is inserted correctly.

ATTACHING AND REMOVING THE LENS

ATTACHING THE LENS

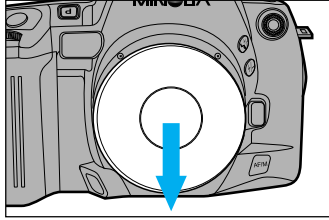

- 1** Remove the camera body cap and the rear lens cap as shown.

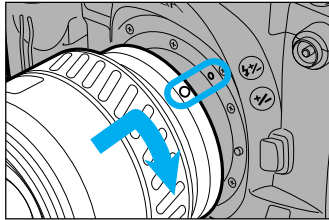
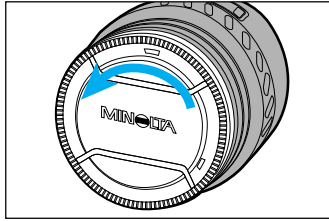

- 2** Align the red bead on the lens with the red dot on the camera's lens mount.
- 3** Gently insert the lens into the mount and turn it clockwise until it clicks into the locked position.

- Do not press the lens-release button while attaching the lens. The lens will turn past its mark and will not work.

REMOVING THE LENS

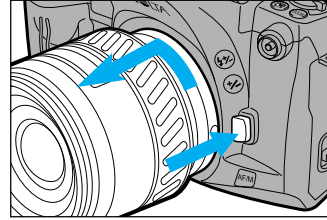

- 1** While pressing the lens release, turn the lens counterclockwise until it stops.
- 2** Gently remove the lens from the mount.

Attach the body cap or another lens to the camera and replace the rear lens cap.

- This will protect the camera interior, lens contacts, and lens elements.

- Do not force the lens onto the body if it does not turn smoothly.
- Do not touch the inside of the camera, especially the lens contacts and mirror.
- Touching or lifting the mirror may impair the mirror's alignment or scratch it. Dust on the mirror will not affect meter readings or picture quality. If it is distracting, have the camera cleaned at an authorized Minolta Service Facility.
- Remove dust, dirt, and moisture from the lens mount before attaching or removing the lens.
- The use of a lens hood is recommended to reduce flare and ensure maximum image quality when the flash will not be used.

LOADING FILM

Remove and discard the protective cover in the film gate before loading film for the first time.

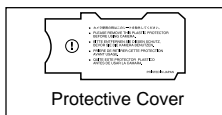

Check the film window before loading film. If a film cartridge is loaded, do not open the back cover. See page 24 for instructions on rewinding a partially exposed roll of film.

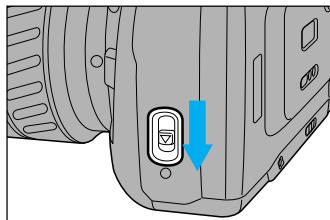

1 Slide the back-cover release down to pop open the back cover.

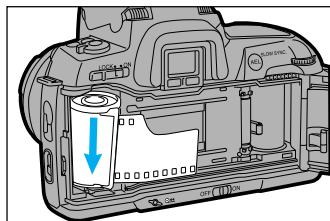

2 Place the film cartridge in the film chamber as shown.

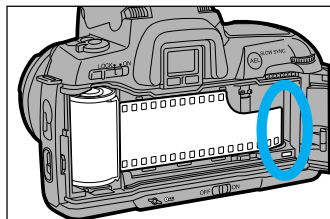

3 Extend the leader between the guide rails to the film-leader index.

- If the film tip extends beyond the red mark, gently push the excess film back in the cartridge.

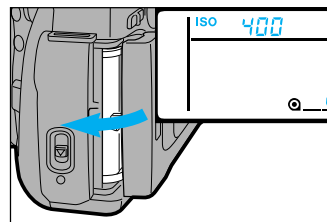
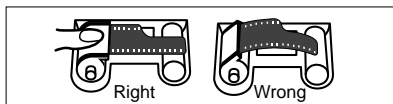

4 Close the back cover and slide the main switch to ON.

- The camera will automatically advance the film to the first frame and 1 will appear in the frame counter in the data panel.
- If DX-coded film is used, the camera will automatically set the correct film speed and display it in the data panel for 5 seconds after loading.

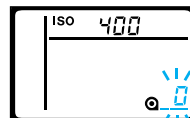

- 1 will blink in the frame counter and the shutter will remain locked if the film is loaded incorrectly. Open the back cover and repeat steps 2 through 4.

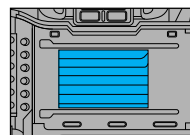

- Never touch the shutter curtain with your fingers or with the film tip. Its precision design makes it extremely sensitive to pressure.

- Always load film in subdued or shaded light to reduce the chances of fogging the film.
- Do not use Polaroid instant 35mm film. Winding problems may occur.
- Non DX-coded film:
If non-DX-coded film is used, the ISO setting of the previous roll of film will be used.
The camera assumes the number of frames is no more than 36. If a roll of non-DX-coded film with more than 36 exposures is loaded, please change the Film Rewind Start customized setting to manual start (p 102).

HANDLING THE CAMERA

HOLDING THE CAMERA

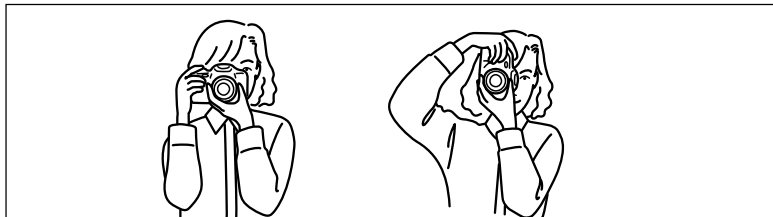

Hold the camera grip firmly with your right hand while supporting the lens with your left hand. Keep your elbows at your side and your feet shoulder-width apart to hold the camera steady. Always keep the camera strap around your neck or wrist in the event you accidentally drop the camera.

- Do not touch the focusing ring of an AF lens or the end of the lens barrel of an xi-Series Autozoom lens.
- Do not block the AF illuminator when autofocus is in use.
- Use a tripod when shooting with long shutter speeds or a telephoto lens.

PRESSING THE SHUTTER RELEASE BUTTON

Press the shutter-release button partway down to activate the camera's autofocus and autoexposure systems. Gently press the shutter-release button all-the-way down to take the picture - never use a quick jab.

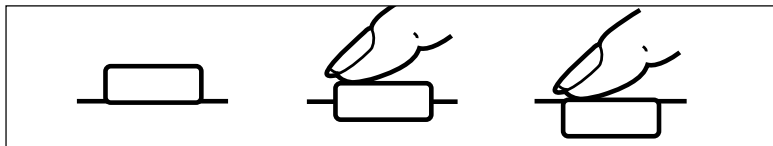

DIOPTRER ADJUSTMENT

If you are near or far sighted, use the diopter adjustment to adjust the eyepiece for your eyesight. The diopter adjustment range is from -2.5 to +0.5 diopters.

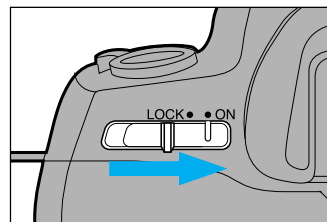

- 1 Slide the main switch to on.

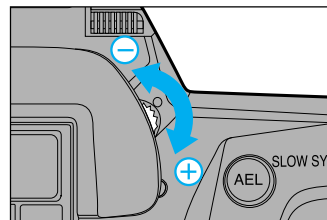

- 2 Look through the viewfinder and turn the diopter-adjustment dial until the focus frame outlines appear the sharpest.

- If the focus frame does not appear, press the shutter-release button partway down.
- Turn the dial in the + direction if you are farsighted. Turn the dial in the - direction if you are nearsighted.

- ✎ If additional correction is needed, a Minolta Eyepiece Corrector can be attached to the camera's eyepiece.
- ✎ The diopter adjustment dial is easier to turn if the eyepiece cup is removed.

EYE-START

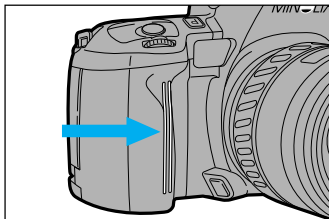

Grip sensor

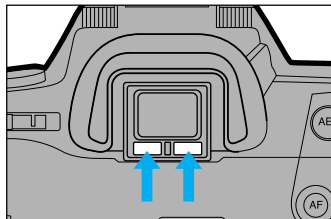

Eyepiece sensor

The eye-start system automatically activates the 800si's main systems as soon as you bring the camera to your eye. When you set the main switch to ON, the data panel and grip sensor activate. Touching the grip sensor activates the infrared emitter detector located beneath the eyepiece. When an object is detected near the viewfinder, autofocus and autoexposure immediately activate so the camera is already operating by the time you frame your subject.

- When an object is no longer detected near the eyepiece or you break contact with the grip sensor while looking through the viewfinder, autofocus and autoexposure will remain active for an additional five seconds.
- Wearing sunglasses that absorb infrared light or gloves may affect the operation of eye-start.

TURNING EYE-START ON/OFF

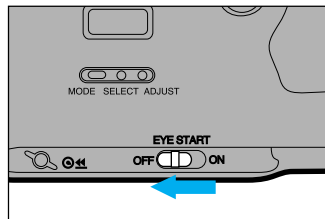

Slide the eye-start switch to ON or to OFF.

- When eye-start is off, activate the camera by pressing the shutter-release button partway down.
- When the camera is on, the focus frame will appear in the viewfinder even with eye-start off.

Customize Function #15 - Eye-start Switch

The function of eye-start switch can be changed to add a dial lock. Dial lock is convenient when you are shooting in M, P_A, or P_s mode, so an accidental turn of the control dials does not change your shutter speed or aperture setting. Custom settings:

- 1 - Normal. Eye-start switch ON - Eye-start on.
Eye-start switch OFF - Eye-start off.
- 2 - Eye-start always on. Eye-start switch ON - dial lock on.
Eye-start switch OFF - dial lock off.
- 3 - Eye-start always off. Eye-start switch ON - dial lock on.
Eye-start switch OFF - dial lock off.

Customize Function #7 - Eyepiece Sensor Activation

The eyepiece sensor can be activated by the grip (standard method) or can be activated with only the main switch set to ON. This is convenient when you are wearing gloves or won't be touching the grip sensor. See page 102.

SHOOTING IN FULL-AUTO MODE

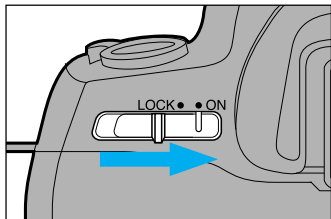

1 Turn the camera on.

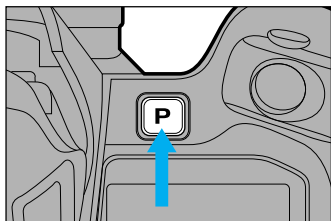

2 Press the program-reset button.

- The camera will return to the default settings.

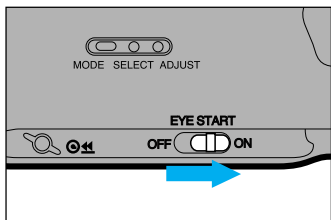

3 Turn eye-start on.

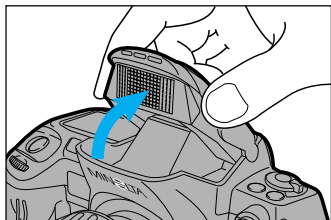

4 Raise the flash if flash is desired. Put the flash down if no flash is to be used.

- The flash always fires when up.

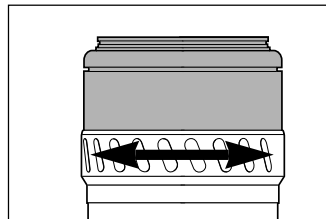

5 Rotate the zooming ring, if using a zoom lens, until your subject is framed as desired.

- For AF Zoom xi or AF Power Zoom lenses, slide the lens' AZ/MZ switch to AZ.

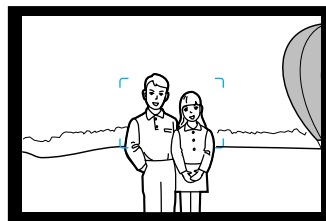

6 Align the subject within the focus area and press the shutter-release button partway down to lock focus and exposure.

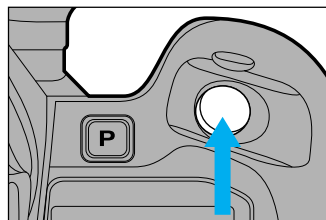

7 Gently press the shutter-release button all the way down to take the picture.

- The film automatically advances to the next frame.

When there are only nine frames remaining on the roll of film, the camera will start a countdown.

The number remaining will appear in the viewfinder.

- The countdown will not appear for non-DX-coded film.

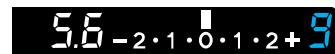

REWINDING THE FILM

After you have exposed the last frame, the camera will automatically rewind the film silently. When the film is completely rewound, the motor will stop and  will blink in the data panel, indicating it is safe to open the back cover.

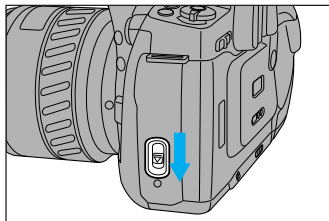

- 1** Wait until rewind is complete.
- 2** Slide the back-cover release down to pop open the back cover.

MANUAL REWIND

Use manual rewind to rewind the film before the roll is finished.

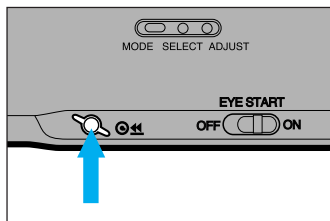

Press the rewind button.

- To rewind the film in high-speed, press the rewind button twice.

Customized Function #12 - Film Rewind Speed

The camera is set for slow/silent rewind when shipped. This can be changed to high-speed rewind with the customize function.

High-speed rewind setting takes about 8 seconds to rewind a 24-exposure roll of film. See page 102.

Customized Function #2 - Film Rewind Start

Automatic rewind start (the default setting) will rewind the film when it reaches the end of the roll (or exposure 36 in non-DX-coded film).

Change the setting to Manual rewind start if desired.

FOCUS BASICS

FOCUS SIGNALS

The following indicators appear in the viewfinder to report focus status.



Continuous focusing - focus confirmed.



Focus is confirmed and locked.



Focusing in autofocus mode - shutter locked.



Focus cannot be confirmed; shutter locked; the subject is too close or in one of the special focusing situations listed on page 30.

- No signals appear while the lens is focusing.

FOCUS LOCK

Use focus lock when you want to take a picture with your subject outside the focus frame [] or when autofocus is difficult to confirm. There are two ways to lock the focus: using the shutter-release button and using the AF button.

LOCKING FOCUS WITH THE SHUTTER-RELEASE BUTTON



- 1 Center your subject in the focus area [].



- 2 Press and hold the shutter-release button partway down.

- The camera will focus on the subject, then lock focus. When focus is locked, ● will appear in the viewfinder.

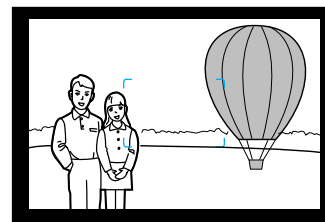

- 3 Recompose the scene while continuing to hold the shutter-release button, then press the button all the way down.

- Focus will remain locked as long as your finger depresses the AF button.

- Make sure your finger has lifted completely off the shutter-release button before taking another photograph if you want the camera to re-focus.

Continued on next page.

LOCKING FOCUS WITH THE AF BUTTON

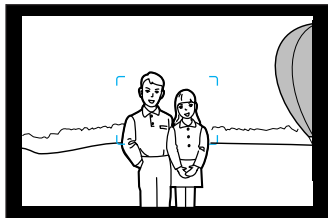

1 Center your subject in the focus area [] .

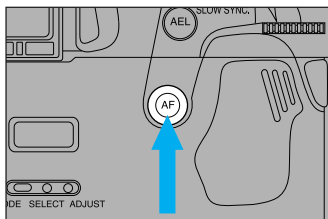

2 Press and hold the AF button.

- The camera will focus on the subject, then lock focus. When focus is locked, ● will appear in the viewfinder.
- A local focus area indicator appears in the viewfinder to show where the camera is focusing on the subject. Choose a different area by turning the front control dial (p 68).

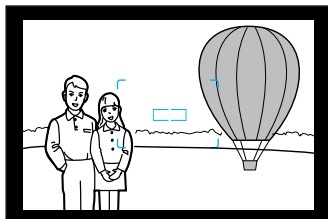
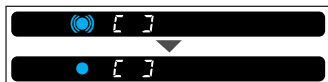

3 Recompose the scene while continuing to hold the AF button, then press the shutter-release button all the way down.

- Focus will remain locked as long as your finger depresses the AF button.

- Make sure your finger has lifted completely off the AF button before taking another photograph if you want the camera to re-focus.

- If the camera is set to 14-segment honeycomb metering, exposure is also locked.
- When Automatic Autofocus is selected, focus may not be able to lock in some situations. In such cases, set the camera to Single-shot Autofocus (p 65).
- The camera cannot lock focus when in Continuous Autofocus mode or if the subject is moving.
- With an xi-series lens, autofocus can be locked by pulling the lens control ring toward the camera. Focus can also be locked with some manual zoom lenses by pressing their focus-hold button.
- It is possible to change between wide-focus area and local-focus area. Turn the front dial while pressing the AF button. See page 67.

Customized Function #9 - AF-Area Selection

The function of the AF button can be changed.

Setting 1 - Normal. Pressing the AF button changes wide-focus frame to local focus area selection (p 102).

Setting 2 - While the AF button is pressed, the center local-focus area is active.

SPECIAL FOCUSING SITUATIONS

In situations like those described below, it may be difficult or impossible for the camera to focus accurately; you may need to use focus lock (p 27) or manual focus (p 31).



If two subjects at different distances overlap within the focus frame.

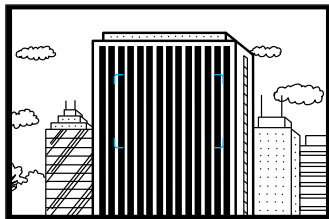

If a subject composed of alternating light and dark lines completely fills the focus frame.



If the subject within the focus frame is very bright, very dark, or low in contrast.

MANUAL FOCUS

When autofocus is not suitable and focus lock is not possible, focus the lens manually.

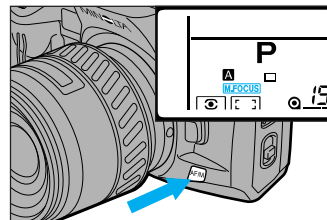

1 Press the focus-mode button to set the camera to manual focus mode.

- M.FOCUS will appear in the data panel.

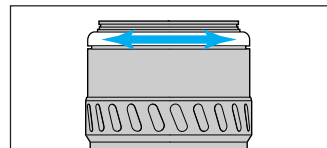

2 AF-series lens: turn the focusing ring until your subject appears sharp.

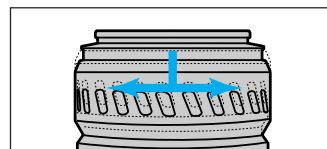

Xi-Series lens/AF power zoom lens: pull and turn the control ring until your subject appears sharp.

- The focus confirmation signal will appear in the viewfinder when the subject is in focus in one of the local focus areas.
- In manual focus mode, the shutter will release even if the subject is not in focus.
- Make sure your finger has lifted completely off the shutter-release button before taking another photograph or the exposure will remain locked.

⏪ Press the focus-mode button to return to autofocus mode.

AF ILLUMINATOR

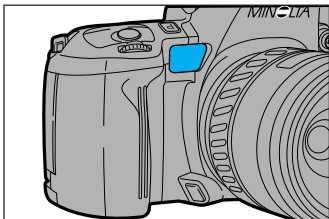

In low light situations or when the contrast of your main subject is too low to be read by the AF sensors, the autofocus illuminator will activate automatically. The AF illuminator projects a pattern of lines onto your subject which the AF sensors detect and use to focus.

- Be careful not to obstruct the AF illuminator while holding the camera.
- The range of the AF illuminator is 0.7 - 7m.
- The AF illuminator will not operate if the camera is in Continuous Autofocus Mode (p 64).
- The AF illuminator will not operate with a 300mm or longer focal length lens (excluding the AF Zoom/AF Zoom xi 100-300 and AF Zoom 75-300).
- The AF illuminator will not operate with the 3x-1x Macro Zoom.
- When a program flash is attached, its AF illuminator will be active in place of the camera's AF illuminator.

FLASH BASICS

USING THE BUILT-IN FLASH

The built-in flash provides coverage for lens focal lengths from 24mm to 80mm. The flash output is automatically controlled by the camera's TTL flash metering system.

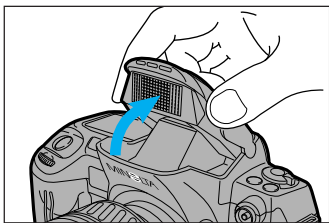

Grip both sides of the flash and gently lift it. The flash will fire every time when it is up.

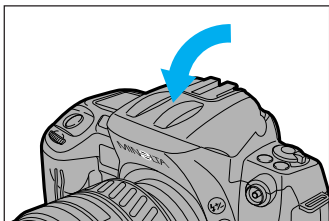

Push the flash down to turn it off.

- The flash is fully charged when ⚡ appears in the viewfinder.
- The flash has a limited range that is dependent on the aperture and film speed. See page 36.

Customized Function #5 - Flash Control in P-Mode

The default setting is Manual Switchover; the flash will fire every time the shutter-release button is pressed when the flash is up. Autoswitchover is available through the customize settings; the flash will fire only when necessary when it is up and P-mode is set. See page 102.

FLASH SIGNALS

The following indicators will appear in the viewfinder to report the status of the flash.



Flash is charged and ready.



(Blinks after a photograph is taken.) Flash output was sufficient to provide correct exposure.



High-speed Sync Flash is ready (p 87). Only available with the 5400HS flash unit (sold separately).



Wireless/Remote Flash is selected (p 92).



Use of flash is recommended. This symbol only blinks when Autoswitchover is selected in Customized Function #5, the camera is in P mode, the subject is backlit, and the built-in flash is down.

FLASH RANGE

The range of the built-in flash depends on the speed of the film and the selected aperture. Make sure your subject is within the working range of the flash, specified in the tables below.

With ISO 100 Film

Aperture	Coverage of the Zoom Flash	
	24mm Focal Length	80mm Focal Length
f/2.8	1.0-5.0m/3.3-16.4 ft.	1.0-7.1m/3.3-23.3 ft.
f/3.5	1.0-4.0m/ 3.3-13.1 ft.	1.0-5.7m/3.3-18.7ft.
f/4	1.0-3.5m/3.3-11.5 ft.	1.0-5.0m/3.3-16.4 ft.
f/5.6	1.0-2.5m/3.3-8.2 ft.	1.0-3.5m/3.3-11.5 ft.

With ISO 400 Film

Aperture	Coverage of the Zoom Flash	
	24mm Focal Length	80mm Focal Length
f/2.8	1.0-10.0m/3.3-33 ft.	1.0-14.2m/3.3-46.6 ft.
f/3.5	1.0-8.0m/3.3-26.2 ft.	1.0-11.4m/3.3-37.4 ft.
f/4	1.0-7.0m/3.3-23 ft.	1.0-10.0m/3.3-33 ft.
f/5.6	1.0-5.0m/3.3-16.4 ft.	1.0-7.1m/3.3-23.3 ft.

- A shadow in the bottom of your picture (lens shadowing) may appear when using the built-in flash if the subject distance is less than 1 meter/3.3 feet.

Customized Function #16 - Built-in Flash Zoom

Setting 1 - Normal. The built in flash zooms with the focal length of the lens.

Setting 2 - The built-in flash is locked to its widest setting. In this position, the built-in flash produces an even light distribution for use with a 50mm macro lens and subject magnification up to 1/2.

LENS SHADOWING AND THE BUILT-IN FLASH

- Do not use a lens wider than 28mm, this is wider than the coverage of the built-in flash.
- Lens shadowing may occur in the following lenses when the lower focal lengths are used:
 - AF Zoom 28-70mm f/2.8G
 - AF Zoom 17-35mm f/3.5-4.3
 - AF Zoom 28-135mm f/4-4.5
- The built-in flash cannot be used with the following lenses:
 - AF 300mm f/2.8 [High-speed - Apo/tele]
 - AF 300mm f/2.8 [Apo/tele]
 - AF 600mm f/4 [High-speed -Apo/tele]
 - AF 600mm f/4 [Apo/tele]

RED-EYE REDUCTION

When photographing people or animals at night or other low-light situations, the effect called red-eye may occur due to the flash reflecting off the inside of the subject's eyes. To reduce this effect, use the built-in flash's red-eye reduction mode. When selected, the flash fires a series of small bursts before the main flash burst. This causes the subject's pupils to close, greatly reducing the amount of light which will reflect off the retina.

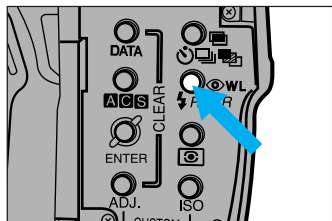

- 1 Press the flash-mode button in the control panel.

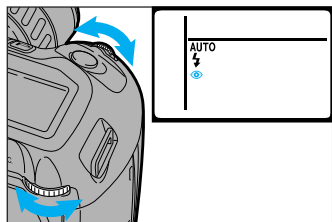

- 2 Turn either control dial until  appears in the data panel.
- 3 Press the shutter-release button partway down to enter the selection.

- Warn your subject that the flash will fire a few short bursts just before the picture is taken.
- ✎ Cancel red-eye reduction by selecting another flash mode.

MEMORY: The Red-eye Reduction setting can be stored in memory. See page 99 for information.

FILL FLASH

When taking portraits outdoors in daylight, use flash to reduce harsh, unflattering shadows on your subject's face. Fill flash should also be used when the subject is backlit.

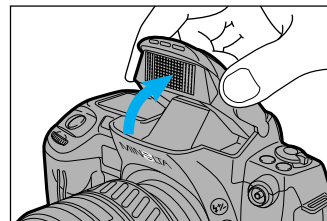

Raise the built-in flash or turn on an attached accessory flash. The flash will fire every time the shutter-release button is pressed.

- In A mode or S mode, the aperture or shutter speed will blink in the viewfinder and data panel if flash will cause the scene to be overexposed with the aperture or shutter speed selected. Adjust the aperture or shutter-speed until it stops blinking (p 53, p 56).

If Autoswitchover has been selected (through Customized function #5) and the camera is in P-mode, the flash will only fire when necessary (p 34, p 102). Because the overall light level is bright, the flash will need to be fired manually.

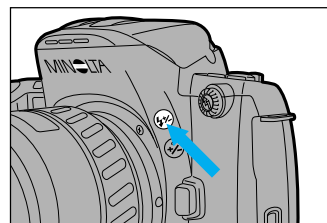

- 1 Press and hold the flash-compensation button.
- 2 Wait until  appears in the viewfinder, then take the picture.

SUBJECT PROGRAM MODES

SUBJECT PROGRAM SELECTION

Subject program selection lets you choose one of the five subject program modes listed below. These program modes customize the exposure settings for the type of picture you will be taking.



Portrait Mode - for portrait photography



Landscape Mode - for scenic and travel photography



Close-up Mode - for close-up photography



Sports Mode - for sports and action photography



Night Portrait Mode - for night portrait and night scene photography

- Pressing the program-reset button returns the camera to its program settings (p 120).

MEMORY: The Subject Program selections can be stored in memory. See page 99 for information.

PORTRAIT MODE



Use Portrait mode when photographing people. Portrait photography benefits from a shallow depth-of-field. A shallow depth-of-field separates the subject from the background. In portrait mode, the camera is set to achieve this effect.

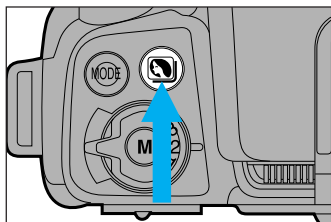

1 Press and hold the subject-program button.

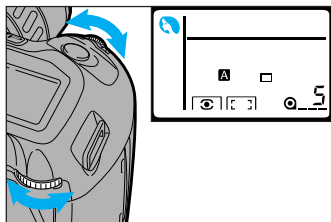

2 Turn either control dial until **A** appears alone in the data panel.

3 Release the subject-program button.

Tips:

- Use a lens in the mid-telephoto range.
- Use flash when your subject is backlit or there are strong shadows across the face.

LANDSCAPE MODE



Select Landscape mode for scenic, landscape, or travel photographs. Landscape photography generally requires a large depth-of-field to make sure the entire scene is in focus. To achieve this, the camera sets the smallest aperture possible while maintaining a fast shutter speed to prevent blur.

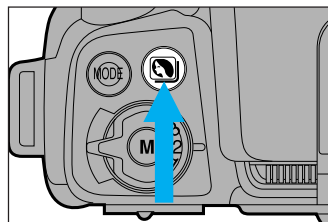

1 Press and hold the subject-program button.

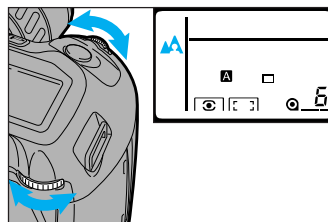

2 Turn either control dial until **A** appears alone in the data panel.

3 Release the subject-program button.

Tips:

- Use a wide angle lens to create a feeling of depth in the photograph.
- Use flash when a subject in the foreground is backlit or has strong shadows across the face. If there is no subject in the foreground, do not use flash.
- Use a tripod, especially at slower shutter speeds.

CLOSE-UP MODE



Use Close-up mode when photographing objects from short distances. Close-up photography requires accurate focusing; use focus hold or manual focus to ensure sharp focus. The camera will select the best possible aperture and shutter speed for your subject.

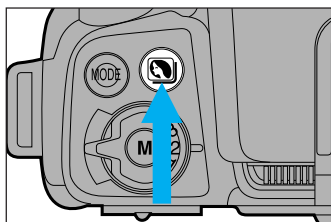

1 Press and hold the subject-program button.

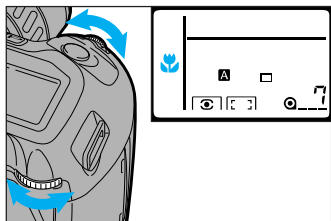

2 Turn either control dial until  appears alone in the data panel.

3 Release the subject-program button.

Tips:

- For best results, use an AF macro lens.
- Do not use the built-in flash when your subject is closer than 1 meter.
- Use a tripod to reduce camera shake.
- Be aware of the minimum focus distance of the lens.

SPORTS MODE



Select Sports mode when faster shutter speeds are needed to stop action. In Sports mode, the camera sets the fastest possible shutter speed and continually adjusts the focus to track fast-moving subjects.

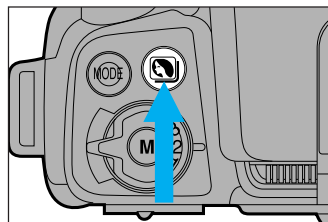

1 Press and hold the subject-program button.

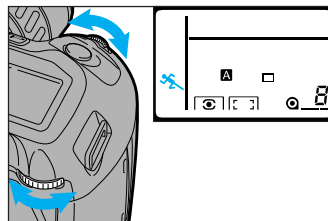

2 Turn either control dial until  appears alone in the data panel.

3 Release the subject-program button.

Tips:

- Use fast film and keep the focus frame on your subject.
- Mount the camera on a tripod when using a telephoto lens.
- Flash is only helpful if the subject is within the flash range.

NIGHT PORTRAIT MODE



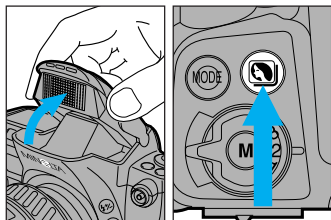

Use Night portrait mode for taking portraits with scenic backgrounds at night. Night portraits require a balanced exposure between the camera's flash and the ambient light. In this mode, the camera sets the largest possible aperture and a slower shutter speed to allow the ambient light in the background appear in the photograph.

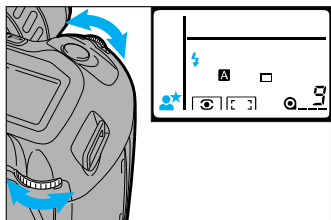

1 Raise the built-in flash.

2 Press and hold the subject-program button.



3 Turn either control dial until  appears alone in the data panel.

4 Release the subject-program button.

Tips:

- Warn your subject not to move while the picture is taken.
- Use faster film and a tripod.
- Set the flash to  when using night portrait mode.

PHOTOGRAPHING NIGHT SCENES

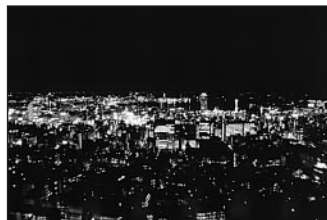

When photographing scenery at night, set the camera to Night Portrait mode and do not use the flash. Longer shutter speeds are set in this mode, so you can easily capture beautiful photographs of twilight scenery and night skylines.

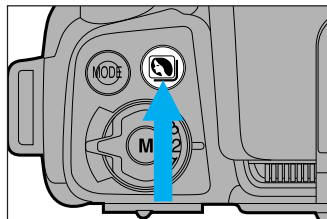

1 Press and hold the subject-program button.

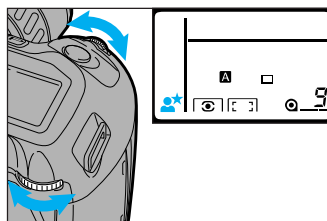

2 Turn either control dial until  appears alone in the data panel.

3 Release the subject-program button.

Tips:

- Use faster film and a tripod.
- When photographing dark night scenes, it may be difficult for the camera to focus. Use manual focus or focus lock.

EXPOSURE BASICS

EXPOSURE MODES

The 800si has four exposure modes.

P - (PROGRAM) -Programmed Autoexposure Mode

P mode (PROGRAM) is ideal when you want to give your full attention to the subject and give the camera control over exposure.

A - Aperture Priority Mode

In A mode, you select the aperture and the camera automatically sets the shutter speed required for proper exposure. Use this mode when you want to control depth of field.

S - Shutter Speed Priority Mode

You select the shutter speed in S mode and the camera automatically sets the aperture for the best exposure. Use S mode to have full control over shutter speed settings.

M - Manual Mode

In M mode, you have full control of exposure and the camera's meter index will show you how your settings relate to the TTL meter.

MEMORY: The Exposure Mode setting can be stored in memory. See page 99 for information.

EXPOSURE MODES

CHANGING THE EXPOSURE MODE

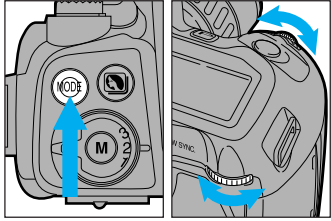

- 1** Press and hold the exposure-mode button.
- 2** Turn either control dial until the mark for the desired mode appears in the data panel.
- 3** Release the exposure-mode button.

SHUTTER SPEED

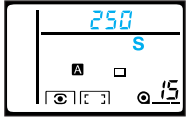

In the data panel and viewfinder, fraction of a second shutter speeds are indicated by whole numbers (from 2 to 8000). For example, if 250 appears, the shutter speed is 1/250 of a second. Shutter speeds in seconds are represented by " after the number. For example 3" is a 3 second exposure (0"7 is 7/10 of a second).

P - PROGRAM EXPOSURE MODE

P mode (PROGRAM) is ideal when you want to give your full attention to the subject and give the camera control over exposure. When focused on your main subject, Expert Program Selection automatically analyzes subject size, motion, and magnification as well as lens focal length. Then, it sets the shutter speed and aperture according to the scene requirements.

- 1** While pressing the exposure-mode button, turn either control dial until P appears in the data panel.
- 2** Release the exposure-mode button to enter the selection.
- 3** Compose your scene and take the picture.

Using the exposure-mode button to set P mode will not change any other camera settings. To return all camera settings to default, press the program-reset button.

PA AND PS: CREATIVE EXPOSURE CONTROL

After the AE system has been activated, you can change the shutter speed or aperture, automatically set by Expert Program Selection, in 1/2-stop increments while maintaining a correct exposure.

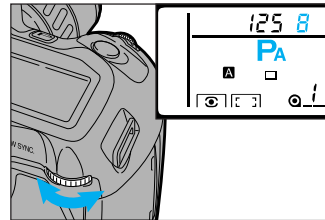

PA - Turn the rear control dial until the desired aperture setting appears in the viewfinder and body data panels. PA appears in the body data panel.

- The aperture will not change, even if lighting conditions change. The shutter-speed value will be set automatically.

Continued on next page.

P - PROGRAM EXPOSURE MODE

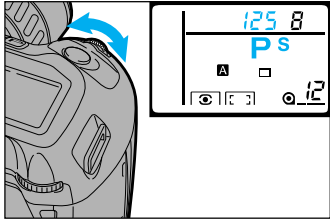

Ps - Turn the front dial until the desired shutter speed setting appears in the viewfinder and body data panels. Ps appears in the body data panel.

- The shutter-speed will not change, even if lighting conditions change. The aperture value will be set automatically.

- In PA mode, if the shutter speed blinks, turn the rear control dial until the blinking stops.
- If the aperture blinks in Ps mode, turn the front control dial until the blinking stops.
- The built-in flash or an attached accessory flash cannot be used in PA and Ps mode. If the built-in flash is up or an accessory flash is attached to the camera and the flash-on indicator  appears in the viewfinder, PA and Ps mode cannot be selected.

CANCELLING PA OR Ps MODE

To cancel PA or Ps and return to P mode, press the exposure-mode button.

PA and Ps will also be cancelled when the built-in flash is raised.

A - APERTURE PRIORITY MODE



In A mode, you select the aperture and the camera automatically sets the shutter speed required for proper exposure. Use A mode when you want to control the depth-of-field in an image (p 55, p 114).

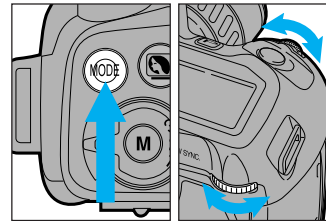

1 While pressing the exposure-mode button, turn either control dial until A appears in the data panel.

2 Release the exposure-mode button to enter the selection.

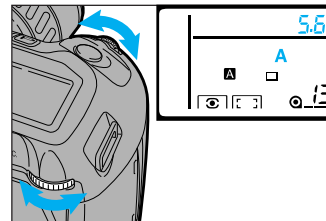

3 Compose your scene and turn either control dial to select the desired aperture. The aperture display will change in 1/2-stop increments with each click of the dial.

- Use the depth of field button to check the focusing range (p 114).

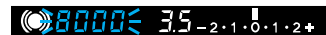
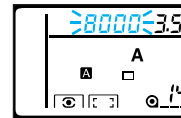

- If the shutter speed blinks in the viewfinder or data panel, the required setting is beyond the camera's shutter speed range. Turn the control dial until the blinking stops to select another aperture.

Continued on next page.

A - APERTURE PRIORITY MODE

A-MODE FLASH

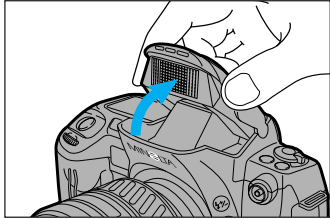

When the built in flash is up or an attached accessory flash is on, it will fire each time a picture is taken. The camera's TTL control ensures a proper exposure.

- When the flash is ready,  will appear in the viewfinder.
- The shutter will stay at or below the camera's top x-sync speed of 1/200. Faster shutter speeds can be used when high-speed flash sync is selected (p 87).
- A larger f-number will result in a smaller flash range.
- Push the flash down if it is not needed.

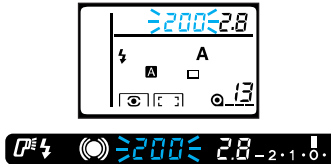

- If 200 blinks in the data panel and viewfinder, the f-number is too low and the photograph will be overexposed. Turn either dial to select a larger aperture number until the shutter speed stops blinking.

APERTURE CONTROL



Large Aperture
(small f-number)



Small Aperture
(large f-number)

The size of the aperture (lens opening) determines the depth-of-field in the final image as well as the intensity of the light falling on the film. Depth of field is the area in front of and behind the point where the lens is focused which will appear sharp.

Large apertures (small f-numbers) limit the depth of field to a narrow range. Choose a large aperture if you want a defocused background so your main subject stands out, such as with portraits.

Small apertures (large f-numbers) provide greater depth-of-field. Choose a small aperture when you want maximum focus range, such as in a landscape photograph.

- In general, wider lenses provide more depth-of-field and longer (telephoto) provide less depth of field.
- There is less depth of field when your subject is close to the lens.

S - SHUTTER PRIORITY MODE



In S mode, you select the shutter speed and the camera automatically sets the aperture required for proper exposure. This mode is useful when you want to control the motion in the photograph.

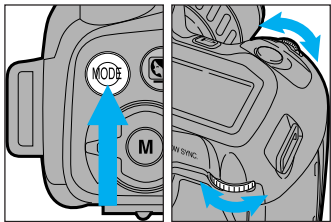

1 While pressing the exposure-mode button, turn either control dial until S appears in the data panel.

2 Release the exposure-mode button to enter the selection.

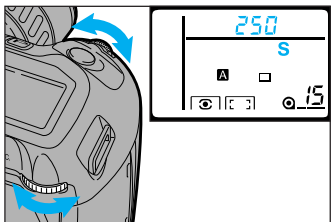

3 Compose your scene and turn either control dial to select the desired shutter speed.

- The shutter speed display will change in 1/2-stop increments with each click of the dial.

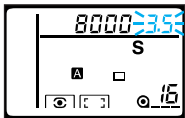

- If the aperture display blinks, a correct exposure is not possible with the shutter speed you have selected. Turn either control dial until the blinking stops to select another shutter speed.



S-MODE FLASH

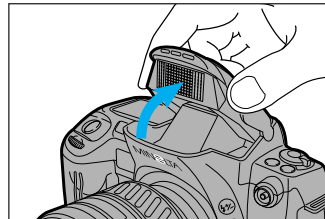

When the built in flash is up or an attached accessory flash is on, it will fire each time a picture is taken. The camera's TTL control ensures a proper exposure.

- When the flash is ready,  will appear in the viewfinder.
- Choose a shutter speed of 1/200 or slower, as this is the sync speed. The aperture is set automatically.
- A larger f-number will result in a smaller flash range.
- Push the flash down if it is not needed.

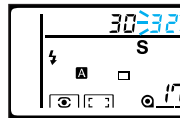

- If the aperture blinks in the data panel and viewfinder, the aperture required for proper exposure is beyond the lens' range. Turn the dial to select another shutter-speed until the aperture stops blinking.

SHUTTER CONTROL



Fast Shutter Speed



Slow Shutter Speed

Because the shutter speed controls the duration of exposures, it also determines how moving subjects will appear in the final image.

Use a slow shutter speed to blur the motion of your subject. Use a fast shutter speed to stop the motion of your subject. In addition to stopping action, fast shutter speeds can help prevent blur caused by camera movement during the exposure.

In M mode, you have full control of exposure and the camera's meter index will show you how your settings relate to the TTL meter.

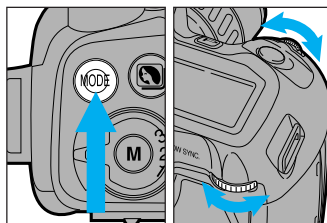

1 While pressing the exposure-mode button, turn either control dial until M appears in the data panel.

2 Release the exposure-mode button to enter the selection.

- The metering index will appear in the viewfinder.

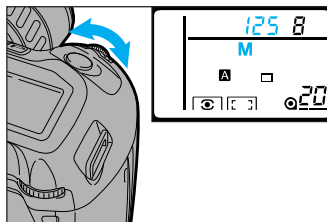

3 Compose your scene. Turn the front dial to change the shutter speed.

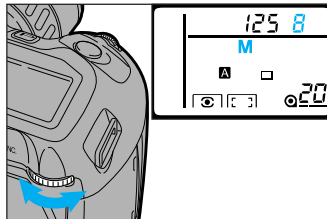

4 Turn the rear dial to change the aperture.

- The shutter speed and aperture displays will change in 1/2-stop increments.

METER INDEX

In manual mode, the metering index will show you how the exposure you have set compares with the camera's meter reading. The 0 position on the index represents the camera's suggested exposure using the current metering method. The pointer indicates your settings in relation to the reading in EVs.

- For Metering Index Information, see page 85.
- For Metering Methods, see page 71.

250 5.6 -2·1·0·1·2+

Your settings match the camera's recommended exposure.

125 5.6 -2·1·0·1·2+

+ 1 EV the camera's recommended exposure

500 6.7 -2·1·0·1·2+

- 1.5 EV the camera's recommended exposure

60 4.5 -2·1·0·1·2+

+ 2.5 EV the camera's recommended exposure

750 8 -2·1·0·1·2+

- 2.5 EV the camera's recommended exposure

750 9.5 -2·1·0·1·2+

- 3.0 EV or below the camera's recommended exposure

90 3.5 -2·1·0·1·2+

+ 3.0 EV or above the camera's recommended exposure

M-MODE FLASH

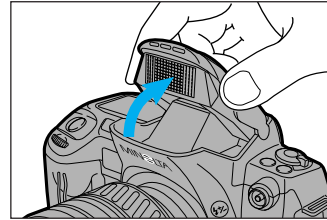

When the built in flash is up or an attached accessory flash is on, it will fire each time a picture is taken. The camera's TTL control ensures a proper exposure.

- When the flash is ready,  will appear in the viewfinder.
- Choose a shutter speed of 1/200 or slower, as this is the sync speed.
- A larger f-number will result in a smaller flash range.
- Push the flash down if it is not needed.

BULB

When bulb is selected, the shutter will remain open as long as the shutter-release button is pressed. Use the bulb function to make long exposures.

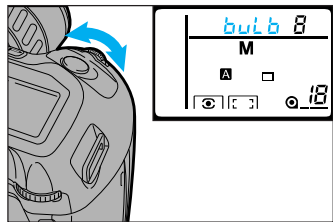

1 Mount the camera on a tripod.

2 While in M mode, turn the front control dial to the left until "bulb" appears in the viewfinder and the data panel.

3 Turn the rear control dial to select the aperture.

4 Compose the scene and focus the lens.

- If the scene is too dark for autofocus to operate, press the focus-mode button and focus the lens manually.
- Attach the eyepiece cap (p 11).

5 Press and hold the shutter-release button to take the picture.

- The shutter will remain open as long as the button is pressed.

✎ To reduce or prevent blurring of the photograph, attach either the Remote Cord RC-1000S or RC-1000L (both sold separately).

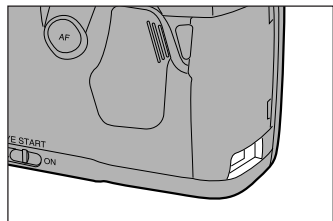

Remove the remote control terminal cover. Then, insert the remote cord's plug into the terminal.

- The shutter will remain open as long as you hold the remote control button down.

ADVANCED AUTOFOCUS

AUTOFOCUS MODES

This camera has three autofocus modes that can be changed at any time.

MEMORY: The Focus Mode setting can be stored in memory. See page 99 for information.

AUTOMATIC AUTOFOCUS MODE



When autofocus is activated by pressing the shutter-release button partway down, the camera will continue focusing while the subject is moving and lock focus when it is still.

Automatic Autofocus Mode **A** works well in any situation, but is especially useful for subjects that move and stop suddenly.

CONTINUOUS AUTOFOCUS



The camera continues focusing while the shutter-release button is pressed partway down. The shutter-release button can be pressed all the way down when the subject is in focus. Continuous Autofocus **C** should be used at sporting events or other occasions when the subject moves continuously.

SINGLE-SHOT AUTOFOCUS



When the shutter-release button is pressed partway down, the camera focuses until sharp focus is confirmed and then focus is locked. Focus will remain locked while the shutter-release button is pressed partway down or until after the shutter-release button is pressed all the way down. Use Single-shot Autofocus **S** when photographing non-moving subjects or subjects that are outside the focus area. See Focus Lock, page 27.

CHANGING THE AUTOFOCUS MODE

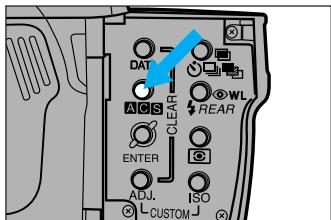

1 Press the AF-mode button in the control panel.

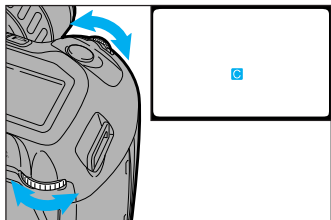

2 Turn either control dial to set the AF mode to **A**, **C**, or **S**.

- Make sure the camera is in autofocus mode. If M. FOCUS appears in the data panel, press the focus-mode button to select autofocus.
- The selected AF mode will remain when a Subject Program Selection is made.
- The AF Illuminator will not operate when **C** mode is selected.

Your camera has a wide focus area and four local focus areas. A wide focus area is ideal for catching subjects in motion and snapshots. A local focus area allows for precise control over the location of focus.



Horizontal (Wide)

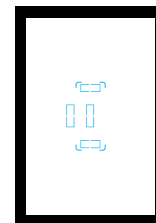

Vertical

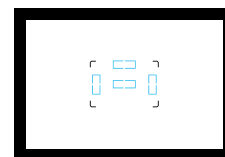

Horizontal (Local)

WIDE FOCUS AREA

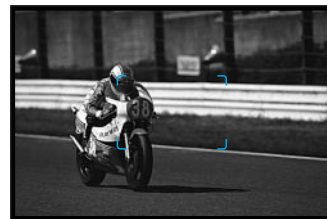

The camera uses all of the AF sensors to focus. It determines which sensor is focusing on the main subject. Wide Focus Area provides flexibility in framing and makes it easier for the camera to focus on moving subjects. The default setting of the camera is wide focus area.

LOCAL FOCUS AREA

Select a specific local focus AF sensor for the camera to use.

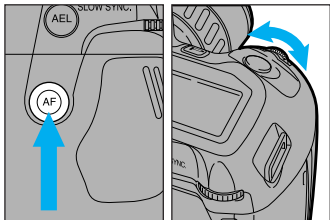

- 1 While pressing the AF button, turn the front control dial to display each local focus area.

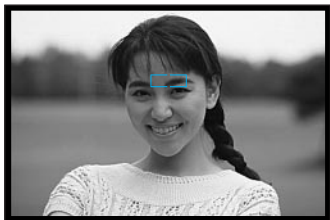

- 2 When the desired local focus area appears in the viewfinder, release the AF button. The selected local focus area indicator will remain in the viewfinder.

- To return to wide focus area, press and hold the AF button and turn the front control dial one click.

- When the RF 500mm lens or the AF Power Zoom 35-80mm lens is attached, only the center local focus area can be selected.
- If Customized Function #6 is on setting 3 (Lens' focus hold button operates Continuous Autofocus), operation of continuous autofocus will be suspended while the dial is turned to select a local focus area.

RELEASE PRIORITY

The default setting of the 800si is autofocus-priority shutter release. When the camera is in autofocus, the shutter will not release if the subject is not in focus. You can set the camera to shutter-release priority so the shutter will release even if the subject is not sharply focused.

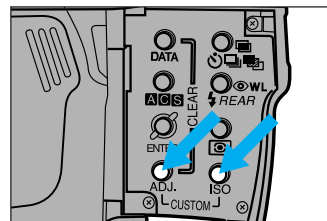

- 1 Press and hold the adjust button and press the ISO button.

- CUST - 1 and a setting number of 1 will appear in the data panel.

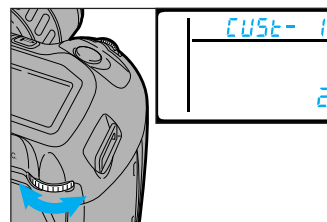

- 2 Turn the rear control dial so the setting number in the lower right corner is changed to 2.

- 3 Press the shutter-release button partway down to enter the selection.

- RP will appear in the data panel.
- Pressing the program-reset button will return the camera to AF Priority.

Customized Function #1 - Release/AF Priority

This page describes the Release/AF Priority customize function. For additional information, see page 99 and page 102.

MEMORY: The Release Priority setting can be stored in memory. See page 99 for information.

Your camera takes meter readings of the light in the scene to determine the correct exposure. The 800si has three methods of taking meter readings. Use the method most appropriate for your subject.

14-SEGMENT HONEYCOMB-PATTERN METERING

Fourteen-Segment Honeycomb-Pattern Metering is the camera's standard metering mode and will be set whenever the program-reset button is pressed (p 120). This mode uses information from the autofocus system to set the metering pattern according to the position of the main subject in the frame. The camera evaluates each of the honeycomb segments separately to determine the degree of spot-lighting or backlighting present in your scene.

ADVANCED EXPOSURE

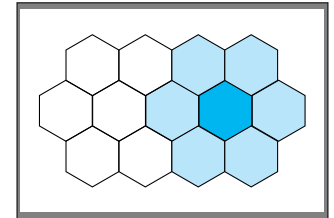
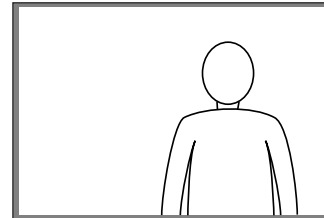
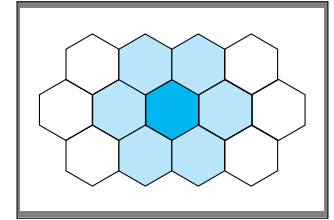
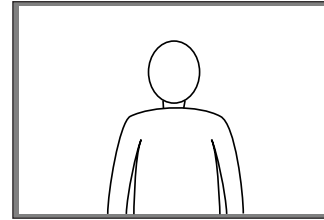

Continued on next page.

CENTER-WEIGHTED AVERAGE METERING

In center-weighted average mode, the exposure is based on an average of the reading made by each of the honeycomb segments - with emphasis placed on the center of the image. Take care when photographing backlit, spotlight, or off-center subjects because the meter may include non-subject areas of your scene when calculating the exposure.

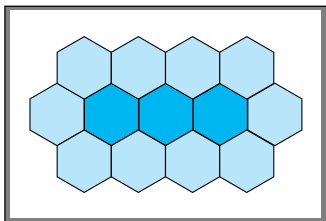

SPOT METERING ●

Spot metering uses only the center segment of the honeycomb pattern. The spot-metering circle appears in the viewfinder to indicate the metering area.

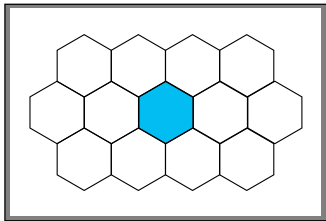

SELECTING A METERING METHOD

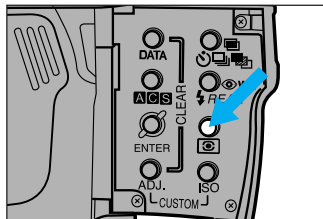

- 1** Press the metering-mode button in the control panel.

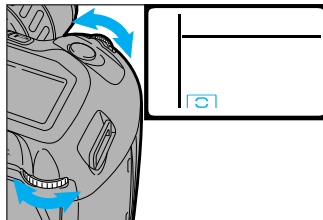

- 2** Turn either control dial until the icon of the desired method appears in the data panel.
- 3** Press the shutter-release button partway down to enter the setting.

MEMORY: The Metering Mode setting can be stored in memory. See page 99 for information.

EXPOSURE COMPENSATION

This function enables you to bias the camera's exposure calculation up to 3 EVs over or under the normal metered setting.

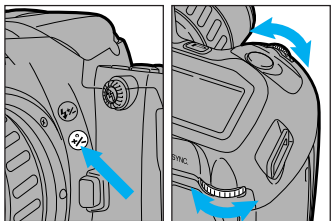

1 While pressing the exposure compensation button, turn either control dial.



2 When the desired compensation value appears in the viewfinder and data panel, release the exposure compensation button.

- The compensation value will disappear from the body data panel, but  will remain in the data panel.
- Press the exposure-compensation button at any time to make the exposure factor appear in the data panel.
- In P, A, and S modes and each subject program mode, the metering index will appear in the viewfinder when the autofocus is activated by Eye-start or pressing the shutter-release button partway down.
- Cancel exposure compensation using the above procedure to set the compensation value to 0.0.

MEMORY: The Exposure Compensation setting can be stored in memory. See page 99 for information.

AE LOCK

Use this function to lock the automatic exposure settings without locking the autofocus.

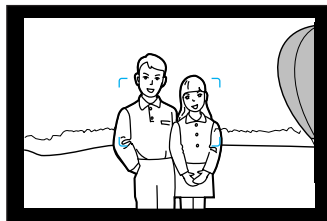

1 Center the subject of which the meter-reading will be made.

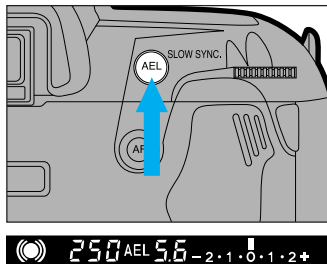

2 Press and hold the AE Lock button.

- AEL appears in the viewfinder and the data panel.
- The spot-metering frame appears in the viewfinder.
- The 0 mark in the meter index represents the AE lock exposure.
- The selected metering method does not change.

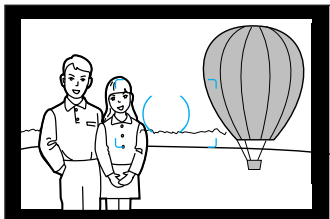

3 While holding the AE-lock button, recompose the picture.

- A mark on the meter index will indicate the difference between the locked exposure (0) and the exposure value of the area currently being read.
- Do not release the AE lock button until after the picture is taken.

4 Press the shutter-release button all the way down to take the photograph.

- Exposure will remain locked as long as your finger depresses the AE-lock button.

⚡ If the flash is up and **P^{FE}** appears in the viewfinder, Slow-shutter Sync will be activated (p 88). The spot-metering frame and a second mark on the index meter will not appear.

Customize Function #10 - AE Lock Button

Setting 1 - In default operation the AE lock button is only active while it is being pressed.

Setting 2 - The operation of the AE-lock button can be changed so AE lock is active after the button is pressed. AE lock remains active until the AE-lock button is pressed a second time. In this setting, AE lock is also cancelled by turning the camera off, turning on the flash, or removing the lens.

Exposure bracketing lets you expose a series of frames with exposures below and above the normal metered exposure. This function is especially useful when shooting with reversal film, because of the film's low tolerance for exposure error. With the 800si, you can choose a series of 3, 5, or 7 frames. The exposures can be made in 0.3, 0.5, or 1.0 EV increments.

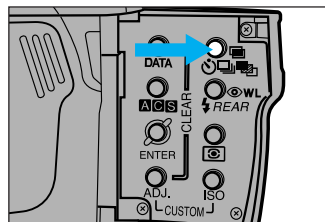

1 Press the drive-mode button in the control panel.

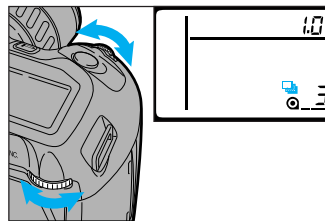

2 Turn either control dial until the exposure-bracketing indicator appears in the data panel.

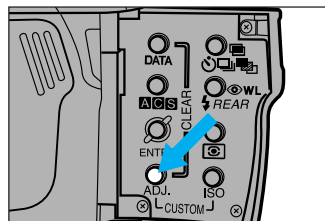

3 Press the adjust button in the control panel.

- The exposure-bracketing indicator will start blinking.

EXPOSURE BRACKETING

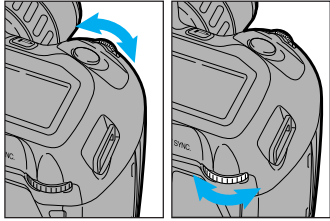

- 4 Turn the front control dial to select the exposure increments.
- 5 Turn the rear control dial until the desired number of frames appears in the data panel.

6 Press the shutter-release button partway down to enter the settings.

7 Compose the picture, then press and hold the shutter-release button until all the frames in the series have been exposed.

- The camera will not take all of the pictures if you remove your finger from the shutter-release button before the series is complete.
- Focus and metering are locked on the first frame of the series.
- Exposure compensation can be used to change the exposure of the bracket.

Customized Function #11 - Exposure Bracketing Sequence

Setting 1 - The default exposure-bracketing sequence is NORMAL, -, +.

Setting 2 - The optional exposure-bracketing sequence is -, NORMAL, +.

In this setting, take care when making bracketing series at the end of a roll of film. The roll may finish before the NORMAL exposure is made.

FLASH BRACKETING

Flash bracketing lets you expose a series of frames with exposures below and above the normal metered exposure while using flash. With the 800si, you can choose a series of 3, 5, or 7 frames. Exposures can be made in 0.3, 0.5, or 1.0 EV increments. The exposure is controlled by the flash output.

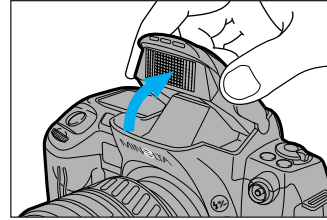

- 1 Raise the built in flash or turn the accessory flash on.
- 2 Follow instructions 1 through 6 for Exposure Bracketing (p 77).

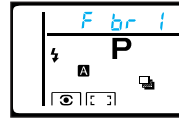

- After the settings are entered, F br 1 appears in the data panel and the viewfinder.



- 3 Wait for the flash-ready signal ⚡ to appear in the viewfinder.

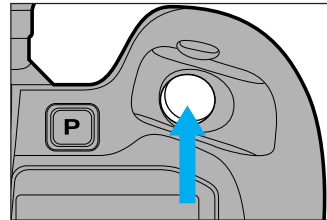

- 4 Press the shutter-release button all the way down to take the picture.

FLASH BRACKETING

5 Repeat steps 3 and 4 until the series is complete.

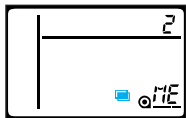

- The data panel and viewfinder will change to indicate the frame number in the bracketing series.

- Flash bracketing is equivalent to fill-flash mode.
 - Do not turn off or remove the accessory flash before the series is complete. The remaining shots will be exposed at the flash sync speed, causing the pictures to be underexposed.
 - Flash bracketing will not operate with an accessory flash that is connected to the camera's PC terminal or the Vertical Control Grip VC-700's PC terminal via a sync cord (the VC-700 is sold separately).
- ∨ To cancel the flash bracketing series before it is complete, push the built-in flash down or turn the camera off.

MULTIPLE EXPOSURE

The multiple-exposure mode lets you overlap up to 9 images on the same frame.

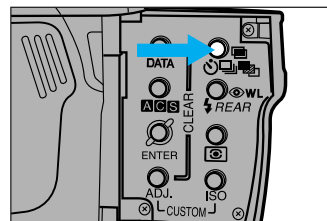

1 Press the drive-mode button in the control panel.

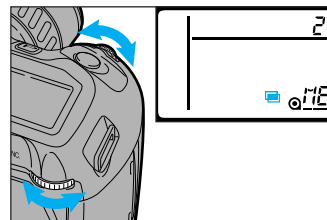

2 Turn either control dial until the multiple exposure indicator  appears in the data panel.

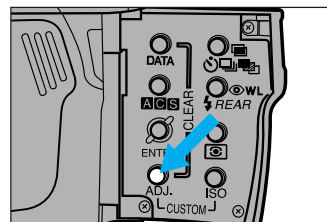

3 Press the adjust button in the control panel.

-  will start blinking.

MULTIPLE EXPOSURE

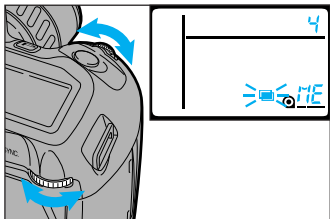

4 Turn either dial to select the number of exposures.

5 Press the shutter-release button partway down to enter the setting.

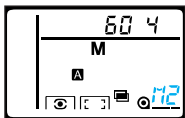

6 Press the shutter-release button all the way down to take the first picture.

- M2 will appear in the data panel.

7 Repeat step 6 until all the exposures have been made.

- Multiple-exposure mode is cancelled and the camera is automatically set to single frame advance after all the exposures have been made.
- If the battery is removed before a multiple exposure series is complete, multiple exposure will be cancelled, but the film will not have advanced to the next frame.
- Tell your photofinisher there are multiple exposure frames on the film. Some photofinishers may not automatically print multiple exposure frames.
- You may want to use exposure compensation to underexpose each exposure so the final image on the frame is not overexposed (p 74).

CANCELLING MULTIPLE EXPOSURE

Cancel multiple-exposure mode by setting another drive mode.

It is also possible to change the number of exposures remaining in the multiple-exposure series after starting the series. Follow the instructions for Setting Multiple Exposure. The number of exposures set will be the number remaining.

Example A: After starting a multiple exposure series, the number of exposures is changed to 1. Multiple exposure mode will cancel after the next exposure is made.

Example B: After shooting 8 exposures of a multiple exposure series, the number of exposures is reset to 9. Multiple exposure mode will cancel after 9 more exposures are made.



- Values 0 - 9 are available.

METERING INDEX

The table below summarizes the meaning of the metering index.

MODE	CAMERA STATUS
P / A / S - Subject Program Modes	Exposure compensation is set in any of the metering methods.
	AE Lock is activated in any of the metering methods.
M Mode	

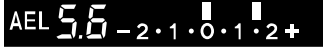
• The arrow pointer blinks if the value is ≤ -3.0 EV OR $\geq +3.0$ EV.

DISPLAY	POINTER
The 0 position represents the exposure calculated by the camera. The pointer is on the exposure-compensation value.	 <p>The exposure compensation is -1 EV of normal exposure.</p>
The 0 position represents the exposure locked-in by the AE button. The pointer represents the value of the spot-meter area when compared to the locked exposure.	 <p>The spot-meter area is $+1.5$ EV of the locked exposure.</p>
The 0 position represents the exposure calculated by the camera. The pointer represents the exposure provided by the manual camera settings.	 <p>The manual exposure is -1.5 EV of the camera's calculated exposure.</p>

ADVANCED FLASH

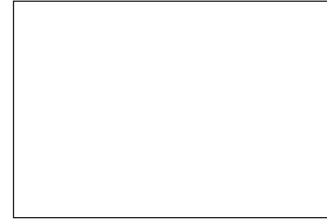

Conventional Fill Flash

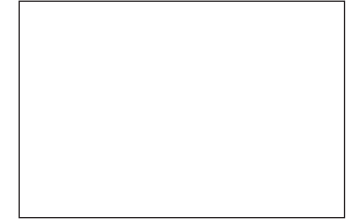

High-speed Sync

The maximum sync speed of the 800si is 1/200. However, with the 5400HS accessory flash (sold separately) shutter speeds up to 1/8000 can be used. High-speed sync (HSS) is particularly useful when photographing portraits outdoors. With it, a larger aperture can be selected to limit the depth of field and separate your subject from the background.

Attach the 5400HS flash and set it to standard mode.

- The camera will automatically switch to HSS mode and $\overline{1/8000}$ will appear in the viewfinder.
- HSS cannot be used under fluorescent lights.
- The shutter will not release in HSS mode while the depth-of-field preview button is pressed.
- When the 800si is in A mode, manual fill flash is being used, and the scene background is very bright, HSS can be used with manual fill-flash (p 39) to obtain a correct exposure.
- Flash bracketing is available in HSS mode.

Please refer to the 5400HS instruction manual for details.

SLOW-SHUTTER SYNC

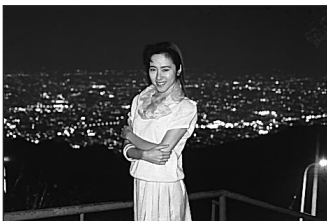

With Slow-shutter Sync



Without Slow-shutter Sync

In P and A modes, slow-shutter sync sets a slower shutter speed to increase the background or ambient lighting exposure in a flash picture. Flash output will automatically be decreased to maintain a correct exposure of your subject.

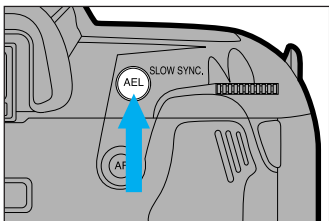

- 1 Frame your subject.
- 2 While pressing the AE-lock button, press the shutter-release button all the way down to take the picture.

- If the background is bright or a large aperture is set (in A mode), the shutter speed may not be reduced.
- Use a tripod if the shutter speed becomes too slow to allow sharp, hand-held pictures after you press the AE-lock button.

CAUTION: Customized Function #10 - AE-Lock Button Setting 2: The AE-lock button is pressed once to turn AE Lock/Slow-shutter Sync on, then must be pressed a second time to turn AE Lock/Slow-shutter Sync off. The AEL indicator will remain in the viewfinder when AE Lock/Slow-shutter Sync is on. See page 102 for more information.

REAR-FLASH SYNC



With Rear-flash Sync



Without Rear-flash Sync

The rear-flash sync function is designed to create action shots that leave a blur of motion behind the subject. Rear-flash sync requires a slow shutter speed to make the 'blur' exposure with the ambient light, then the flash fires to properly expose the subject. Using a slow shutter speed with conventional flash does not produce the same effect, as the flash exposure is made before the ambient exposure, so the blur motion comes after the subject and is unnatural.

- Rear-flash sync can be used with the built-in flash and accessory flashes attached to the accessory shoe or PC terminal.

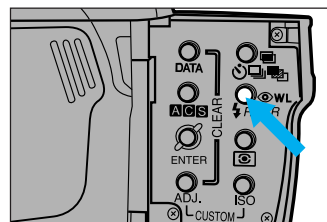

- 1 Press the flash-mode button in the control panel.

REAR-FLASH SYNC

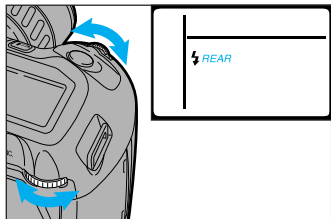

- 2 Turn either dial to display  REAR in the data panel.

- 3 Press the shutter-release button partway down to enter the selection.

- 4 Press the shutter release button all-the-way down to take the picture.

- Select a shutter speed of 1/90 or slower. If a faster shutter speed is selected,  REAR will remain in the viewfinder, but a normal exposure will be made.
- Rear flash sync is not compatible with flash units that have a very long firing duration. An incomplete exposure will occur.

FLASH COMPENSATION

This function enables you to bias the output of the built-in flash or an accessory flash as much as + or – 3 EVs in .5 increments.

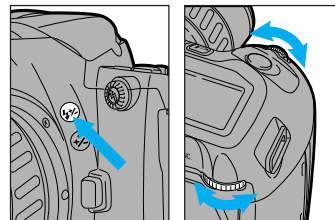

- 1 While pressing the flash-compensation button, turn either control dial.
- 2 When the desired compensation factor appears in the viewfinder and data panel, release the button.

-  will remain in the viewfinder and data panel.
 - Flash compensation does not operate with flash units connected to the PC terminal.
- ✎ Check the compensation amount by pressing the flash-compensation button.
 - ✎ Cancel flash compensation by resetting it to 0.0.

MEMORY: The Flash Compensation setting can be stored in memory. See page 99 for information.

WIRELESS/REMOTE OFF-CAMERA FLASH



Normal Flash



Wireless/Remote Flash



Wireless/Remote Ratio Flash

When used with Minolta 5400HS, 5400xi, or 3500xi flash units (all sold separately), the 800si offers the flexibility of remote/wireless off-camera flash control with TTL flash metering.

Wireless/Remote flash lets you experiment with creative lighting techniques using off-camera accessory flashes without the usual tangle of accessory cords and connectors.

In Wireless/Remote flash mode, the off-camera flash is triggered by a coded signal from the camera's built-in flash when you press the shutter-release button. Another signal stops it once the camera's TTL flash meter detects that proper exposure has been received. A 2:1 lighting ratio can also be obtained automatically. When selected, the off-camera flash provides 2/3 of the full exposure and the built-in flash provides the remaining 1/3.

SETTING WIRELESS/REMOTE FLASH MODE

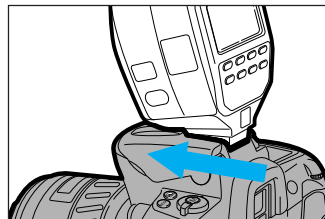

- 1** Attach the flash to the camera, then turn it on.

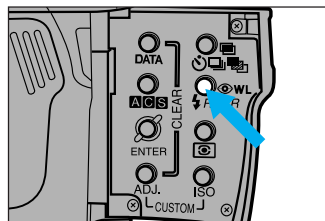

- 2** Press the flash mode button in the control panel.

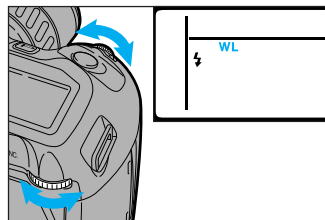

- 3** Turn either control dial until **WL** appears in the data panel. Press the shutter-release button partway down to enter the selection.

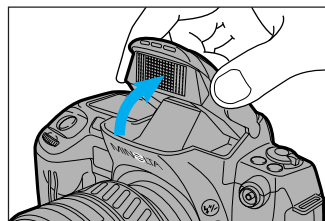

- 4** Detach the accessory flash unit, then raise the built-in flash.

WIRELESS/REMOTE OFF-CAMERA FLASH

TAKING PICTURES IN WIRELESS/REMOTE FLASH MODE

The off-camera flash will provide 100% of the exposure.

1 Position your camera and flash unit using the information on this page.

- These instructions use the 3500xi as the example. For the 5400HS and 5400xi, please refer to the flash unit's instruction manual.

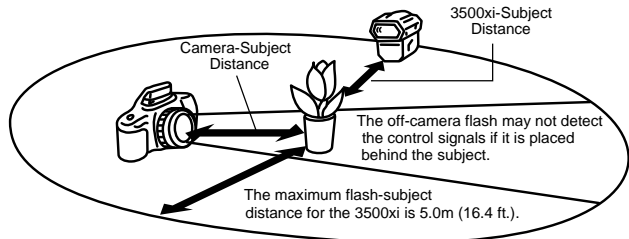

Aperture	Camera-Subject Distance		3500xi Flash-Subject Distance	
	ISO 100	ISO 400	ISO 100	ISO 400
2	2-5m	4-5m	1.4-5.0m	2.8-5.0m
	6.6-16.4 ft.	13.1-16.4 ft.	4.6-16.4 ft.	9.2-16.4 ft.
2.8	1.4-5.0m	2.8-5.0m	1-5m	2-5m
	4.6-16.4 ft.	9.2-16.4 ft.	3.3-16.4 ft.	6.6-16.4 ft.
4	1-5m	2-5m	0.7-4.5m	1.4-5.0m
	3.3-16.4 ft.	6.6-16.4 ft.	2.3-14.8 ft.	4.6-16.4 ft.
5.6	1-5m/3.3-16.4 ft. (1-4m/3.3-13.1 ft.)	1.4-5.0m 4.6-16.4 ft.	0.5-3.2m 1.6-10.5 ft.	1-5m 3.3-16.4 ft.
	1-5m/3.3-16.4 ft. (1.0-2.8m/3.3-9.2 ft.)	1-5m 3.3-16.4 ft.	0.35-2.25m 1.1-7.4 ft.	0.7-4.5m 2.3-14.8 ft.

* Values in parentheses indicate the maximum distance for wireless/remote ratio control (p 96).

- Make sure the AF illuminator on the flash is pointing at the subject.

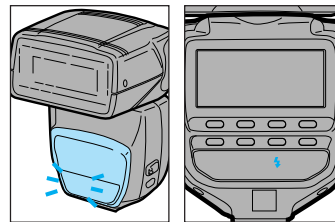

2 Wait for both flash units to become fully-charged.

- When the off-camera flash is charged, its AF illuminator will blink and will glow in the flash's data panel.
- The built-in flash is charged when glows in the viewfinder.

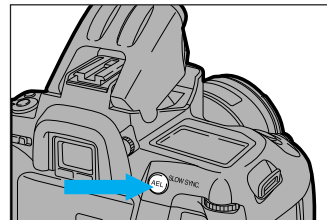

3 Press the AE-lock button to test fire the accessory flash, then wait for both flashes to recharge.

4 Press the shutter-release button all the way down to take the picture.

CAUTION: Customized Function #10 - AE Lock Button
Make sure the AE lock customized function is on setting 1 (normal). If the AE lock customized function is on setting 2, pressing the AE lock button to test-fire the flash will turn slow-shutter sync on. Test-firing the flash a second time will turn slow-sync off. See page 102 for more information.

WIRELESS/REMOTE RATIO FLASH

Follow the instructions for wireless/remote (p 94), but press the flash-compensation button before taking the picture. The built-in flash will also fire and the flash ratio will be 2:1. The built-in flash will provide 1/3 of the exposure and the accessory flash will provide 2/3 the exposure.

CANCELLING THE WIRELESS/REMOTE FLASH

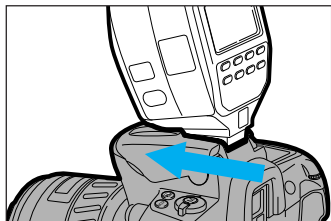

- 1 Attach the accessory flash to the camera and turn the camera and flash on.

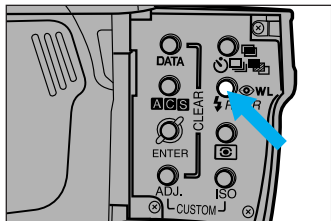

- 2 Press the flash-mode button in the control panel.

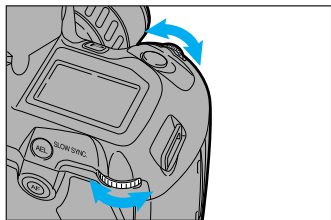

- 3 Turn either dial to select another flash mode, then press the shutter-release button partway down to enter the selection.

This camera is equipped with a PC connector which enables you to connect PC-capable flash units with a flash sync cord.

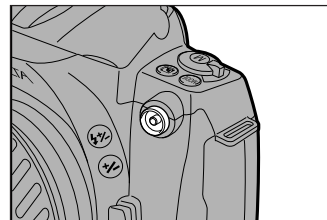

Set the exposure mode to M, then set the shutter to 1/200 or slower.



















- Turn the flash unit off before connecting the sync cord to the PC terminal or the flash unit may fire unexpectedly while connecting.

- Your camera's PC terminal is center-positive; the most common polarity used for PC connections.
- Flash units with an extremely low trigger voltage may not work with the 800si. If your flash has a low trigger voltage, contact a Minolta Service Facility.
- When used with the Vertical Control Grip VC-700 (sold separately) both the camera's PC terminal and the VC-700's PC terminal can be used (together or separately).

ADDITIONAL FEATURES

MEMORY

The memory function allows you to store a variety of camera settings as a group and recall them at anytime. The 800si is capable of storing three different sets of camera function settings. This feature is convenient when you will be repeating the same shooting conditions and want to use the same settings each time.

FUNCTIONS	SETTINGS THAT CAN BE STORED IN MEMORY
Exposure Mode Subject Program	P/ A/ S/ M, Portrait  , Landscape  , Sports  , Close-up  , or Night Portrait  .
Aperture Setting	f/1.0 - f/64 (depends on lens)
Shutter-speed Setting	30 sec. - 1/8000 sec. or BULB
AF Mode	Automatic autofocus  , Continuous autofocus  , or Single-shot autofocus  .
Film Drive Mode	Single-frame advance  , Continuous advance  , Multiple exposure  , exposure-bracketing  , or self-timer  .
Flash Mode	Flash on  , Red-eye reduction  , Rear-flash sync  <i>REAR</i> , Wireless/Remote flash WL .
Exposure Compensation	-3.0 to +3.0 EV (in 0.5 EV steps)
Flash Compensation	-3.0 to +3.0 EV (in 0.5 EV steps)
Metering Mode	14-segment honeycomb  , Center-weighted average  , Spot  .
Focus Frame	Wide focus frame, or any one of the local focus areas.
AF Priority/Release priority*	Autofocus priority or Release priority.

*AF/Release Priority is selected as a customized function. Memory overrides the AF/Release Priority custom function setting.

Continued on next page.

STORING SETTINGS IN MEMORY

- 1 Set the camera with all the function setting you want to save (see chart on the previous page).

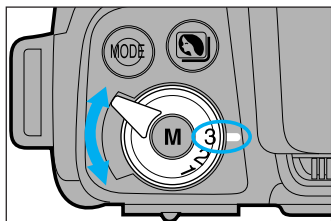

- 2 Assign the group a number by turning the memory-number lever to the desired number.

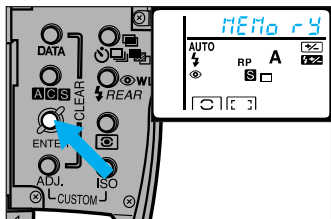

- 3 Press the Enter button in the control panel.

- *MEMO r 3* will briefly appear in the data panel.

- Saving a new set of functions in a memory number that already has settings stored will replace the old settings with the new.
 - The memory settings are not affected by turning the camera off or removing the batteries.
 - When settings are stored or recalled in memory, shutter speed, aperture, exposure compensation values, and flash compensation values do not appear in the data panel, but are set in memory.
- ↘ Clear all three sets of memory settings by pressing and holding the enter button while turning the camera off, then on again.

RECALLING CAMERA SETTINGS IN MEMORY

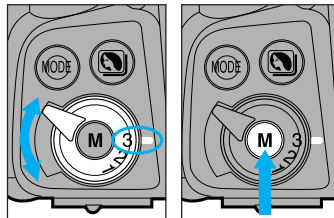

- 1 Turn the memory-number lever to the desired number.
- 2 Press the memory-recall button.

CUSTOMIZED SETTINGS

The customize option lets you reprogram certain camera functions

Custom Function	Control
1	Release Priority*
2	Film Rewind Start
3	Film Tip
4	DX Memory
5	Flash Control in P-Mode
6	Lens Focus Hold Button (if applicable)
7	Eyepiece Sensor Activation
8	Frame Counter
9	AF Area Selection
10	AE Lock Button
11	Exposure Bracket Sequence
12	Film Rewind Speed
13	Viewfinder Display Duration
14	Show AF Area
15	Eye-start Switch
16	Built-in Flash Zoom

according to your personal preferences.

Setting	Action
1	AF Priority
2	Release Priority
1	Auto
2	Manual
1	Rewind into cartridge
2	Out of rewind cartridge
1	On
2	Off
1	Manual switchover
2	Autoswitchover
1	Focus hold
2	Center-area select
3	Continuous AF
1	Grip switch
2	Main switch
1	Normal
2	Counts down
1	Wide or Local
2	Center only while pressing AF button
1	Active while button is pressed
2	Active after button is pressed, cancelled after button is pressed again
1	Normal, -, +
2	-, Normal, +
1	Silent (slow)
2	Fast
1	5 sec.
2	10 sec.
3	30 sec.
1	When AF button is pressed
2	When focus is locked
1	Turns eye-start on & off
2	Turns dial-lock on & off, eye-start is always on
3	Turns dial-lock on & off, eye-start is always off
1	Linked with focal length
2	Fixed to wide

CUSTOMIZED SETTINGS

All customized settings were set to 1 before your camera was shipped.

CHANGING THE CUSTOMIZED SETTINGS

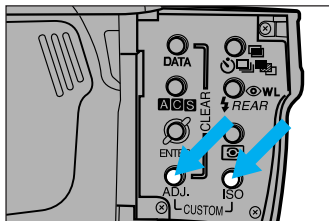

- 1 While pressing the adjust button, press the ISO button.

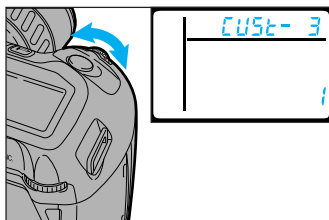

- 2 Turn the front dial to select the number of the Customized Function.

- In the example: Customized Function #3 - Film Tip has been selected.

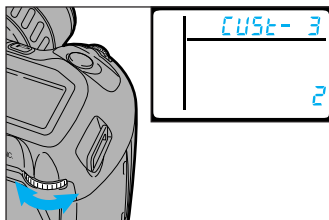

- 3 Turn the rear dial to change the setting.

- In the example: Setting 2 - (leaving the film tip out of a rewind cartridge) has been selected.

- Repeat steps 2 and 3 until all the desired functions are selected.

- 4 Press the shutter-release button partway down to enter the selections.

- Turning the camera off or removing the batteries will not affect the Customized Function Settings.

- ✎ Release Priority is the only customized function that can be set in memory. It is also the only customized function that can be changed by the memory-recall button and program-reset button.

Note: When Customized Function #15 - Eye-start Switch is on setting 2 or 3, the dials are completely disabled when the switch is set to ON. In this case, the only function the dials will operate is the Customized Setting.

RESETTING ALL THE CUSTOMIZED SETTINGS TO 1

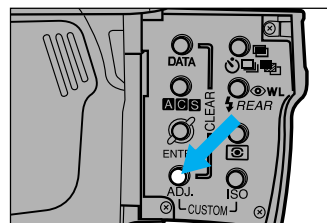

- 1 Press and hold the adjust button in the control panel.

- 2 Slide the main switch to LOCK then return it to ON.

- When the operation is complete, **ILL** will blink in the data panel and every custom setting will be set to 1.

DATA MEMORY

When data memory is selected, the following information about each photograph is stored at the time of exposure:

- Aperture
- Lens focal length
- Exposure compensation
- Shutter speed
- Flash status (on/off)
- Flash compensation (if used)
- Bracketing/flash bracketing (on/off)

Data memory can store information from 9 rolls of film with up to 40 exposures on each roll.

FILM AREAS

The data from each of the 9 rolls of film is stored separately in nine different areas called "film areas". The first roll of film is stored in film area 1, the second in film area 2, and so on. When all the data areas are full, information from the next roll of film will be stored in data area 1, erasing the previous data.

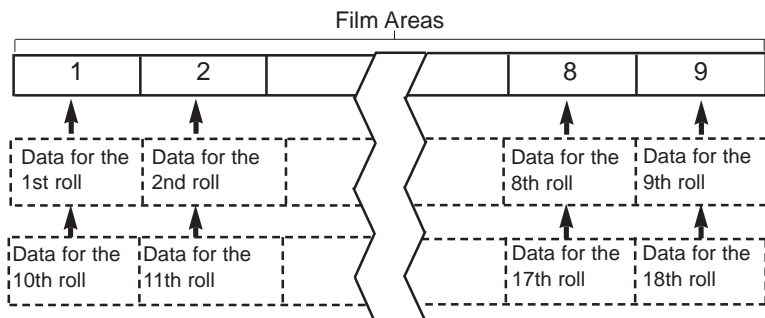

- Film area selection is automatic. It is not possible to select a certain film area on to which you want to record.

OVERWRITING THE FILM AREAS

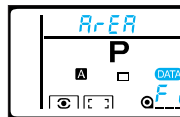

When all 9 film areas are full, *Err* will appear in the data panel as a warning before Film Area 1 is overwritten.

- This warning appears only when the film area changes from 9 to 1. The warning disappears after the first exposure is made.

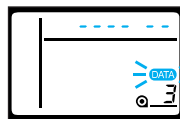

The old information in the data area is overwritten one frame at a time. A frame between the old and the new information is erased and left blank.

SELECTING DATA MEMORY

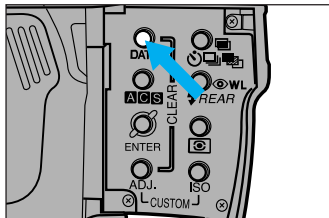

1 Press the data-memory button in the control panel.

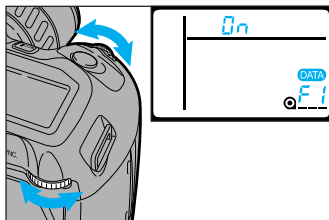

2 Turn either control dial until **On** appears in the data panel.

- The film area where the data is to be stored will appear in the bottom right corner.

3 Press the shutter-release button partway down to enter the selection.

- **DATA** will appear in the data panel when data-memory is on.

Turn data memory OFF using the steps above, turn either control dial until **OFF** appears in the data panel in step 2.

CONFIRMING THE DATA AREA

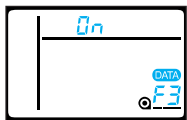

Press the data-memory button at anytime to see in which data area information is being recorded.

Example: F3 indicates you are now recording in film area 3.

DATA RECALL

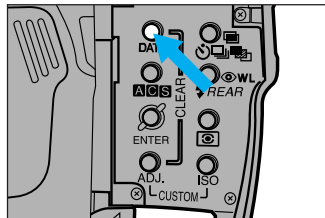

1 Press the data-memory button in the control panel.

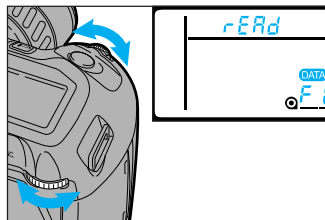

2 Turn either control dial until **r-ERd** appears in the data panel.

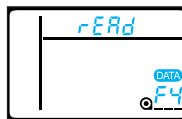

3 Continue turning the dial until the number for the desired data area appears.

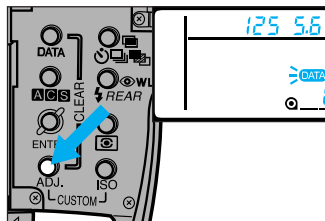

4 Press the adjust button.

- The display in the data panel shows the aperture and shutter speed information for the first frame.

DATA blinks in the data panel.

- 5** Turn the rear control dial one click to view more information about the frame. The display will change as follows:

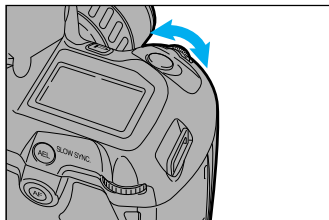
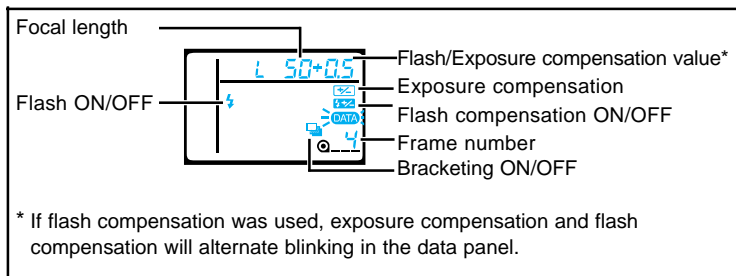
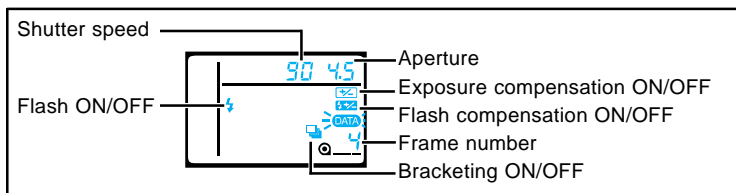

- 6** Turn the front control dial to change frames.
- Repeat step 5 to view information about the displayed frame.

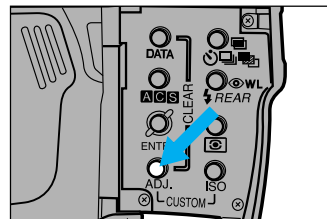

\overline{Fn} appears, then press the shutter-release button partway down to enter the setting.

- 7** Press the adjust button again to return to the data-memory ON/OFF/READ screen.

- Repeat steps 2 through 6 to view information in other data areas.
- To exit the data-memory screen, turn either dial until either \overline{OFF} or

DELETING ALL OF THE STORED DATA

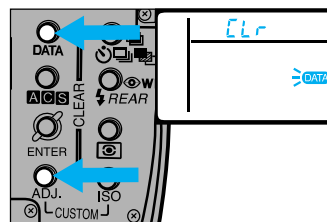

- 1** Press and hold the data-memory button in the control panel.

- 2** Press the adjust button.

- \overline{ELR} will appear and \overline{DATA} will blink in the data panel.
- Release both buttons.

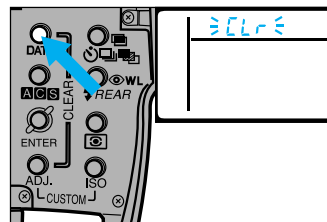

- 3** Press the data-memory button again.

- \overline{ELR} will blink while the data is being deleted.
- The stored data will be completely deleted. The data panel will return to the standard display.

- This will delete the data in all of the film areas. It is not possible to select a specific film area to clear.
- Do not operate the camera while \overline{ELR} blinks in the data panel.

FOR OWNERS OF THE QUARTZ DATE MODEL

The Quartz-data function enables you to record the date or time onto the lower-right portion of the photograph. The 800si has an automatic calendar through the year 2019.

• In this section, when the ADJUST button is referred to, it is the ADJUST button for the Quartz Data function. It is not the adjust button in the control panel.

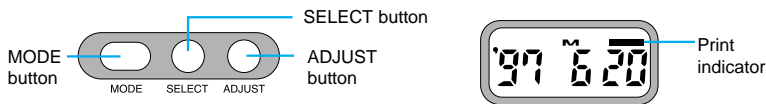

SETTING THE DATE AND TIME

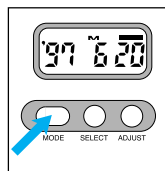

1 Press the MODE button to choose the data imprinting format.

- M will appear above the month.
- The display will change as follows:

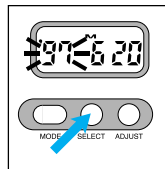
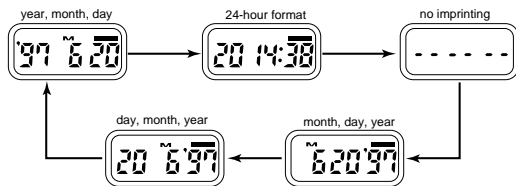

2 Use the SELECT button to move between different parts of the displayed data. The selected part will blink, indicating that it is the data to be changed.

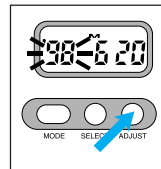

3 Press the ADJUST button to change the data to the correct value. Data continues changing as long as the button is held down.

- In time mode, pressing the ADJUST button while : is blinking resets the second counter to 00.

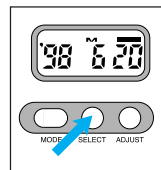

4 When all data is correct, press the SELECT button until the data stops blinking.

- The print indicator will flash for 2 seconds after the picture is taken to indicate that the data was imprinted.

- Imprinted data may be difficult to read if the lower-right corner of the photograph is bright or non-uniform.
- Imprinting position and size may differ according to printing conditions.
- Do not use the data back when temperatures exceed the operating range of 0° to 50° C (32° to 122° F).

REPLACING THE QUARTZ DATA BACK BATTERY

The quartz data back uses a CR2025 lithium battery, located on the inside of the back cover. Replace the battery if the display changes or becomes dim while the camera batteries are removed.

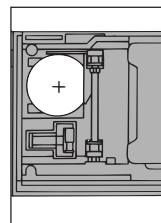
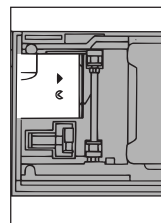

1 Slide the battery cover in the direction indicated.

2 Remove the old battery and replace it with a new one.

- The + side should face up.

3 Replace the battery cover, then reset the date and time.

DEPTH-OF-FIELD PREVIEW

When the lens is focused on a subject, there is a range behind and in front of the subject that appears sharp. This range is called depth of field.

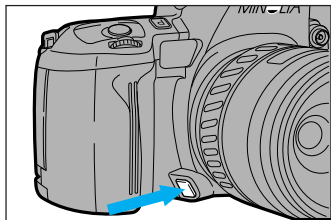

To check how much of your scene will appear in focus, press the depth-of-field preview button.

- The lens is stopped down to the aperture that appears in the data panel. If the aperture is small (large f-number) the image will look darker through the viewfinder. This is normal.

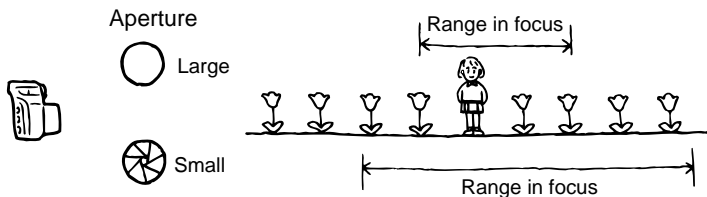

- The exposure setting cannot be changed while the depth-of-field preview button is pressed.

Depth of field can be increased by:

1. Using smaller apertures (larger f-stop numbers).
2. Using short focal length (wider angle) lenses.
3. Moving farther away from your subject.

SETTING FILM SPEED MANUALLY

The film speed can be set manually when you want to override the DX-coded film speed or you are using non-DX-coded film. Film speeds can be set from ISO 6 to ISO 6400 in 1/3EV increments.

- If a film speed is not set for non-DX-coded film, the ISO of the previous roll will be automatically used.

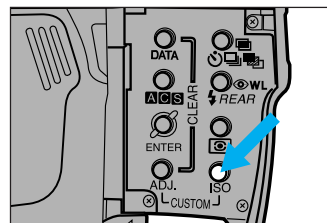

- 1** Load the film, then press the ISO button in the control panel.

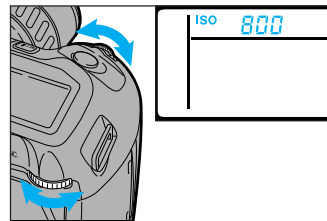

- 2** Turn either control dial to change the ISO value.

- 3** When the desired value appears in the data panel, press the shutter-release button partway down to enter the selection.

- For flash exposures, we recommend film speeds between ISO 25 and 1000.

SETTING FILM SPEED MANUALLY

DX Memory

If you change the ISO of a DX-coded roll of film, the new speed is recorded and used for all following rolls with the same initial film speed. This is called DX Memory.

Example: You manually change the film speed of a DX-coded roll of ISO 100 film to ISO 400. The next time you insert a DX-coded roll of ISO 100 film, the camera automatically resets the ISO to 400.

The default DX Memory setting is ON.

Customized Function #4 - DX Memory

Setting 1 - DX Memory is on.

Setting 2 - DX Memory is off. The camera will not automatically change the ISO of any DX-coded film. See page 102.

SELF-TIMER

The self-timer delays the release of the shutter for approximately 10 seconds after the shutter-release button is pressed.

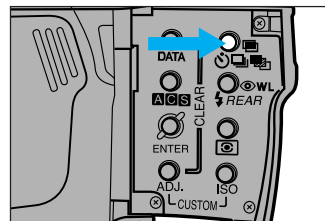

1 Place the camera on a tripod, then press the self-timer/drive-mode button in the control panel.

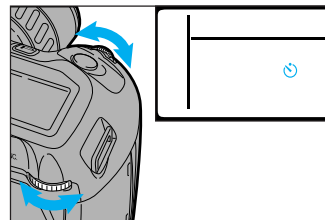



2 Turn either control dial until the self-timer icon appears in the data panel. Press the shutter release button partway down to enter the setting.

3 Center your subject in the focus frame, then press the shutter-release button all the way down to start the timer.

- The self-timer lamp will blink after the shutter-release button is pressed. Three seconds before the picture is taken, the self-timer lamp will blink rapidly.

- To cancel the self-timer before taking the picture, slide the main switch to LOCK.
- The self-timer is cancelled automatically after the shutter is released.
- If you are not looking through the viewfinder when the shutter-release button is pressed, light entering the eyepiece may affect the camera's automatic exposure settings. To prevent this, attach the eyepiece cap before starting the self-timer (p 11).

FILM DRIVE MODES

The 800si has two film-drive modes: Continuous Advance  and Single Frame Advance . In Single Frame Advance, the camera makes one exposure and advances the film one frame each time the shutter-release button is pressed. In Continuous Advance, the camera will release the shutter and advance the film (up to 3 frames per second) as long as the shutter-release button is held down.

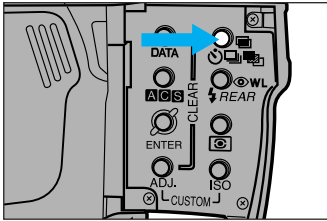

1 Press the self-timer/drive-mode button in the control panel.

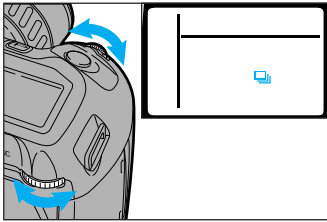

2 Turn either control dial until  appears in the data panel. Press the shutter-release button partway down to enter the setting.

- When Autofocus Priority is selected, the shutter will not release until sharp focus is confirmed. To release the shutter even if sharp focus is not confirmed, change Customized Function #1 (AF Priority/Release Priority) to Release priority (setting 2). See page 69 and page 102.
- When the camera is in release-priority mode (RP), the shutter releases even if the subject is not in focus.
- Lens "Power Zoom" functions do not operate in Continuous mode (AF Zoom xi and AF Power Zoom lenses included).

APPENDIX

PROGRAM RESET BUTTON

Press the program-reset button to return the following camera functions to their program settings.

Function	Program Setting	Page
Exposure mode	P mode	51
Subject Program	None (P mode)	51
Focus area	Wide	67
Focus	Autofocus	31
AF Mode	Automatic autofocus	64
Metering mode	14-segment honeycomb pattern	71
Exposure compensation	+/- 0.0	74
Flash compensation	+/- 0.0	91
Film-drive mode	Single frame advance	118
Self-timer	Off	117
Wireless Flash	Off	92
Rear-flash Sync	Off	89
Shutter-release mode	Autofocus priority	69

- The program-reset button will not change:
 - Red-eye Reduction (on/off)
 - Data Memory (on/off)
 - Film Speed (ISO setting)
- If you have a dedicated accessory flash attached to the 800si, pressing the program-reset button will also return it to its own program settings. Refer to the flash instruction manual for details.

ACCESSORY INFORMATION

The Minolta 800si was designed to work specifically with lenses, flash units and other accessories manufactured and distributed by Minolta. Using incompatible products with this camera may result in unsatisfactory performance or damage to the camera or accessories.

COMPATIBILITY OF LENSES AND ACCESSORIES

Lenses

- All Minolta AF lenses can be used with this camera.
- Manual focus lenses (MD or MC) cannot be used with the 800si.
- If using an AF Zoom xi or AF Power Zoom lens, display the current focal length of the lens by pulling the zoom ring toward the camera body. If eye-start is off, the focal length can be displayed by pressing the shutter-release button partway down while pulling the zoom ring.

Flash Units

- All Minolta i, si, and HS series flash units, as well as the Vectis SF-1 flash, are compatible with this camera. With these flash units, the flash always fires when the flash unit is on. (Unless Customized Function #6 is on setting 2; Autoswitchover. In this case, the flash will fire only when necessary when it is on and the camera is in P mode.)
- For AF series flash units (4000AF, 2800AF, 1800AF, and Macro flash 1200AF), the Flash Shoe Adapter FS-1100 is required. When the flash is on, it will fire every time the shutter is released. The AF illuminator will not activate.
- X-series flash units can only be used when connected to the camera's PC terminal by a sync cord.

TROUBLESHOOTING

Others

- The following accessories are not compatible with the 800si:
Control Grip CG-1000 Data Receiver DR-1000
Creative Expansion Cards Vertical Control Grip VC-507
- Please contact a Minolta Service Facility before using the Close-up Defuser CD-1000.

VERTICAL CONTROL GRIP VC-700

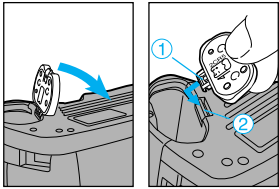

To attach the Vertical Control Grip VC-700 (sold separately), the battery chamber cover must first be removed. Open the battery chamber and gently press the cover back until it snaps off. Reattach the cover by aligning the notch with the bar and gently pressing them back together.

- Never twist the battery cover when removing or reattaching it.
- The VC-700's spot button will function like the camera's AE-lock button.

PANORAMA ADAPTER

The camera's viewfinder frame must be changed to panorama when the Minolta Panorama Adapter (sold separately) is inserted into the camera. Even if the adapter is not inserted, you can use the panorama frame to compose your shots and later have them printed as panoramic pictures.

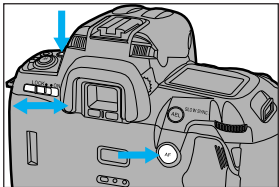

While pressing the AF and subject-program buttons, slide the main switch from LOCK to ON.

- The panorama frame will appear in the viewfinder.
- Repeat the procedure to return to the standard frame.

BLINKING INDICATORS

Indicators blink in the viewfinder and data panel when there is a problem with exposure.

Mode	Indicator	Cause	Solution
P/A/S/M and Subject Program Modes		Scene or subject brightness is beyond the camera's metering range.	For bright scenes, attach a neutral density (ND) filter or reduce the overall brightness of the scene.
P		Light level is beyond the range of available shutter speeds and apertures.	For dark scenes, increase the brightness of the area with flash.
P _A /A		The required shutter speed is beyond the range of the camera.	Select a larger/smaller aperture until the display stops blinking.
P _S /S		The required aperture is beyond the range of the camera.	Select a faster/slower shutter speed until the display stops blinking.

Continued on next page.

TROUBLESHOOTING

Refer to this page to determine the cause of a problem you are experiencing with your camera.

Problem	Check the following
No display is in the data panel when the main switch is set to ON	Is the battery installed correctly? Is the battery exhausted?
Autofocus does not operate when the shutter-release button is pressed partway down.	Is M. FOCUS displayed in the data panel?
	Is the subject in one of the special focusing situations listed on page 30?
	How close is the camera to the subject?
Shutter will not release.	Is the lens compatible? Is the lens attached properly?
	Is Autofocus-release priority (AF priority) selected?
	Is the camera attached to a telescope?
Err is displayed in the data panel.	
MEM appears in the data panel.	Is Data Memory on? Are all the film areas full?

If the information does not cover the problem you are experiencing or the condition continues, contact a Minolta Service Facility.

Solution	Page
Install a new battery if the battery is dead.	12
Press the Focus-mode button to select autofocus.	31
Use focus lock or focus the lens manually.	27, 31
Make sure you are not closer than the minimum focus distance listed in the lens' instruction manual.	–
Use a compatible lens and attach it properly.	14,121
In AF priority, the shutter will not release unless sharp focus is confirmed. To release the shutter even if focus is not confirmed, switch to Release priority.	69
Contact a Minolta Service Facility before attaching the camera to a telescope.	–
Remove and reinstall the battery. If normal camera operation does not resume, contact a Minolta Service Facility.	12
To begin overwriting film area 1, take the next picture.	106

CARE AND STORAGE

CLEANING

- If the camera or lens barrel is dirty, wipe it gently with a soft, clean, dry cloth. If the camera or lens comes in contact with sand, gently blow away loose particles - wiping may scratch the surface.
- To clean the lens surface, first brush away any dust or sand, then (if necessary) moisten a lens tissue with lens cleaning fluid and gently wipe the lens in a circular motion, starting from the center.
- Never place lens fluid directly on the lens.
- Never touch the interior of the camera, especially the mirror and shutter curtain. Dust on the mirror will not affect the picture quality.
- Never use compressed air to clean the camera's interior, doing so may cause damage to sensitive interior parts.
- Never use organic solvents to clean the camera.
- Never touch the lens surface with your fingers.

STORAGE

When storing your camera for extended periods, please follow these guidelines:

- Remove all batteries from the camera.
- Attach the protective caps.
- Store in a cool, dry, and well-ventilated area away from dust and chemicals (such as moth balls). For very long periods, place the camera in an airtight container with a silica gel drying agent.
- Periodically release the camera's shutter to keep it operating properly.
- Before using after prolonged storage, check the camera's operation to make sure it is functioning properly.

BEFORE IMPORTANT EVENTS

- Check the camera's operation carefully or take test photographs.
- Minolta is not responsible for damages incurred by equipment malfunction.

OPERATING TEMPERATURES AND CONDITIONS

- This camera is designed for use from -20° to 50°C (-4° to 122°F).
- Never leave your camera where it may be subjected to extreme temperatures, such as the glove compartment of a car.
- In colder temperatures, the data panel response time will be slow. The display will temporarily darken in higher temperatures. The display will be restored when the camera is returned to normal temperatures.
- Never subject your camera to extreme humidity.
- To prevent condensation from forming when bringing the camera from a cold exterior to a warm building, place it in a plastic bag. Allow it to come to room temperature before removing it from the bag.

BATTERIES

- Battery performance decreases with lower operating temperatures. When photographing in cold weather, we recommend you keep the camera and spare batteries inside your coat to keep them warm when you are not shooting. Cold batteries will regain some of their charge when they warm up.
- The low-battery symbol may appear even with a fresh battery, depending on storage conditions. To restore camera power, turn the main switch to LOCK and then to ON.

CAMERA HANDLING

- Never touch the camera's shutter curtain, mirror, or lens contacts.
- Never subject the camera to impact.
- The 800si is neither waterproof nor splashproof.
 - Inserting/removing film or batteries with wet hands may damage the camera.
 - Take care when using the camera at the beach or near water. Costly or irreparable damage to the camera may occur.
 - If the camera gets wet, immediately discontinue use and contact a Minolta Service Facility listed on the back cover of this manual.

- Camera Type:** 35mm single lens reflex (SLR) with built-in flash, autoexposure (AE), and action-predictive autofocus (AF)
- Lens Mount:** Minolta A-type bayonet mount (Maxxum/Dynax lenses)
- Focus:**
Type: Through-the-lens (TTL) phase detection, multi metering with CCD line sensor metering cell. Autofocus and manual focus modes.
AF Sensitivity Range: EV -1 to 19 (ISO 100)
AF Illuminator: Built-in LED with range of 0.7 - 7m. Automatically activated in low-light, low-contrast situations
AF Control: Single-shot, continuous, automatic AF-mode selection.
- Exposure:**
Modes: P, P_A, P_S, A, S, M, and 5 Subject Program modes (Portrait, Landscape, Close-up, Sports, Night portrait/scene)
Type: TTL metering; direct TTL metering for flash.
Metering Cell: 14-segment honeycomb pattern SPC for ambient light and flash-metering SPC for flash.
Metering Range (f/1.4 lens): Multi-segment metering: EV 0 - 20, EV 3- 20 (spot metering)
Film-speed Setting: Automatic setting for DX-coded film from ISO 25 to 6400. Manual setting from ISO 6 to 6400, 1/3 EV increments. With flash, ISO 25 - 1000.

TECHNICAL DETAILS

Shutter:

Type: Electronically-controlled, vertical-traverse, focal-plane shutter.

Speeds: Bulb, 30 sec. - 1/8000 sec.

Maximum flash sync speed is 1/200 (synchronizes with all speeds in HSS mode).

Built-in Flash:

GN: 14 - 20 (ISO 100 in meters)

Control: Manual up/down

Coverage: 24 - 80mm angle of view

Recycling Time: Approx. 3 sec.

Modes: Fill flash, Fill-flash with red-eye reduction, Wireless flash, Rear-flash sync, (Flash cancel) Rear-flash-sync is compatible with the built-in flash and all usable dedicated flashes.

Dedicated Flashes: Compatible

Viewfinder:

Type: Eye-level fixed pentaprism with 92 x 94% field of view

Eyereief: High-eyepoint; approx. 22.9mm from the eyepiece, 18.9mm from the eyepiece frame

Focusing Screen: Acute matte (interchangeable on service basis)

Magnification: 0.75x (with 50mm at ∞)

Diopter: -1

Diopter Adjustment: -2.5 to +0.5 diopter

Film Transport:

Loading: Auto loading (automatically advances to the first frame when back cover is closed)

Drive Modes: Single frame, continuous (3 frames/sec.), self-timer, exposure or flash bracketing, multiple exposure (2 - 9 exposures)

Rewind: Auto rewind, manual start (Count-down display)

Rewind Time: Standard (slow/silent) - approx 23 sec (36 exp. roll), High speed - approx. 12 sec (36 exp. roll)

Frame counter: Forward (shows number of exposures taken)

Data Panel:

Backlit on-body LCD (automatically illuminated in low-light situations)

Power:

Battery

Performance:

60 rolls with flash 0% (at 20°C)

22 rolls with flash 50% (at 20°C)

13 rolls with flash 100% (at 20°C)

Dimensions:

153.5 x 107 x 71.5mm (WxHxD)

Weight:

628g (without battery)

640g (with Quartz Data Back, without battery)

Specifications are based on the latest information available at the time of printing and are subject to change.

NOTES



NOTES

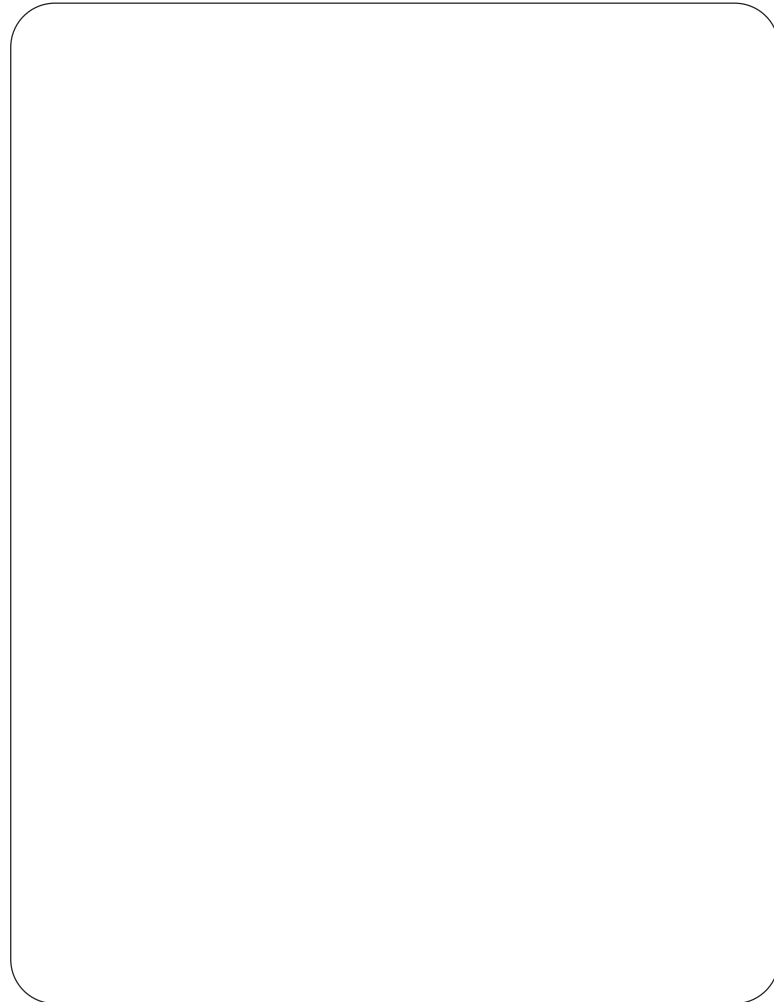

Minolta Co., Ltd.	3-13, 2-Chome, Azuchi-Machi, Chuo-Ku, Osaka 541, Japan
Minolta GmbH	Kurt-Fischer-Strasse 50, D-22923 Ahrensburg, Germany
Minolta France S.A.	365 Route de Saint-Germain, F-78420 Carrières-Sur-Seine, France
Minolta (UK) Limited	Rooksley Park, Precedent Drive, Rooksley, Milton Keynes, MK13 8HF, England
Minolta Austria Ges. m.b.H.	Amalienstrasse 59-61, A-1131 Wien, Austria
Minolta Camera Benelux B.V.	Zonnebaan 39, P.O. Box 6000, NL-3600 HA Maarssen, The Netherlands
Belgium Branch	Kontichsesteenweg 38, B-2630 Aartselaar, Belgium
Minolta (Schweiz) AG	Riedstrasse 6, CH-8953 Dietikon, Switzerland
Minolta Svenska AB	P.O.Box 9058, Albygatan 114, S-17109 Solna, Sweden
Finland Branch	Niittykatu 6 PL 37, SF-02201 Espoo, Finland
Minolta Portugal Limitada	Rua Afonso Lopes Vieira 55-B, P-1700 Lisboa, Portugal
Minolta Corporation	
Head Office	101 Williams Drive, Ramsey, New Jersey 07446, U.S.A.
Los Angeles Branch	11150 Hope Street Cypress, CA 90630, U.S.A.
Minolta Canada Inc.	
Head Office	369 Britannia Road East, Mississauga, Ontario L4Z 2H5, Canada
Vancouver Branch	230-3771 Jacombs Road, Richmond, B.C. V6V 2L9, Canada
Minolta Hong Kong Limited	Room 208, 2/F, Eastern Center, 1065 King's Road, Quarry Bay, Hong Kong, China
Minolta Singapore (Pte) Ltd.	10, Teban Gardens Crescent, Singapore 608923
Shanghai Minolta Optical Products Co., Ltd.	368 Minolta Road, Songjiang, Shanghai, China

© 1997 Minolta Co., Ltd. under the Berne Convention
and universal Copyright Convention