

MINOLTA

AUTO METER IV F

E INSTRUCTION MANUAL

F MODE D'EMPLOI

INTRODUCTION

The Minolta Auto Meter IV F's versatile operation will help simplify your most critical applications. It includes such basics as ambient, cord and non-cord measuring modes, average calculation, and memory space for two separate readings. In addition, flash measurements from 1/500 - 1 sec., brightness difference calculation, a wide film-speed range, and digital as well as analog displays will further enable you to apply the Auto Meter IV F to virtually any exposure or lighting situation you encounter. You will then be free to concentrate more fully on creative details.

Next, a word about this manual. It is divided into several sections to make it easier for you to learn about the meter and to find specific information whenever you need it. The first two **Names of Parts and Displays** and **Preparations** should be read before you begin using the Auto Meter IV F. **Basic Operation** then explains how to use the meter to make ambient and flash measurements. The next section, **Special Functions**, describes how to use the Auto Meter IV F's main features. Finally, **Applications**, explains some uses for these features that will enable you to realize the full potential of your Auto Meter IV F.

TABLE OF CONTENTS

NAMES OF PARTS AND DISPLAYS	2
BODY	2
DATA PANEL DISPLAYS.....	6
PREPARATIONS	8
BATTERY	9
Inserting	9
Low-Power Warning.....	10
SETTING FILM SPEED	11
SELECTING A MEASURING METHOD	12
Incident-Light Readings.....	12
Reflected-Light Readings.....	14
BASIC OPERATION	16
MEASURING AMBIENT LIGHT	17
With a Still Camera	17
With a Cine Camera.....	19
MEASURING FLASH LIGHT	22
With a Sync Cord.....	22
Without a Sync Cord	25
SPECIAL FUNCTIONS	28
MEMORY	29
AVERAGE	32
BRIGHTNESS DIFFERENCE	34
RE-CALIBRATION	36
APPLICATIONS	37
LIGHTING-RATIO MEASUREMENTS.....	38
SCENE-CONTRAST MEASUREMENTS	41
USING THE ANALOG SCALE	45
FILTER-FACTOR CORRECTION.....	47
ILLUMINANCE MEASUREMENTS	49
ACCESSORIES	51
CARE AND STORAGE	54
SPECIFICATIONS	56

NAMES OF PARTS AND DISPLAYS

BODY

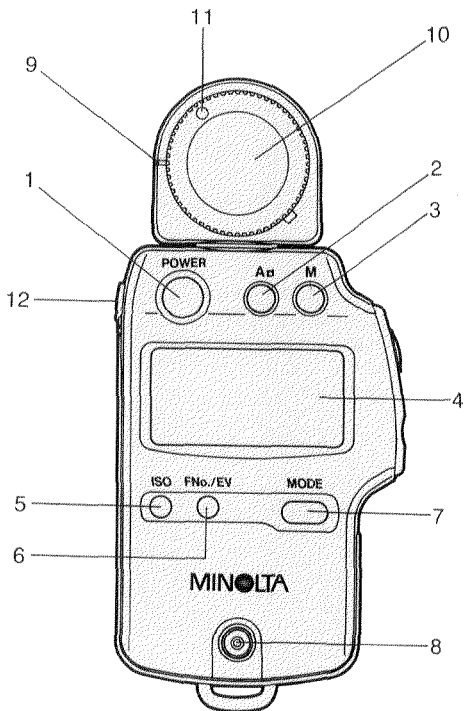

1. Power button
turns power on and off; clears memory
2. Averaging button
displays average of two stored readings; activates brightness difference
3. Memory button
stores displayed reading in memory
4. Data panel
5. ISO button
selects ISO for adjustment with up/down control
6. Display-selector button
changes display units between f/number and EV
7. Mode button
changes measuring mode
8. Sync terminal
outlet for sync cord
9. Receptor mounting index
10. Spherical diffuser
11. Diffuser mounting index
12. Accessory-receptor jack
outlet for accessory receptor

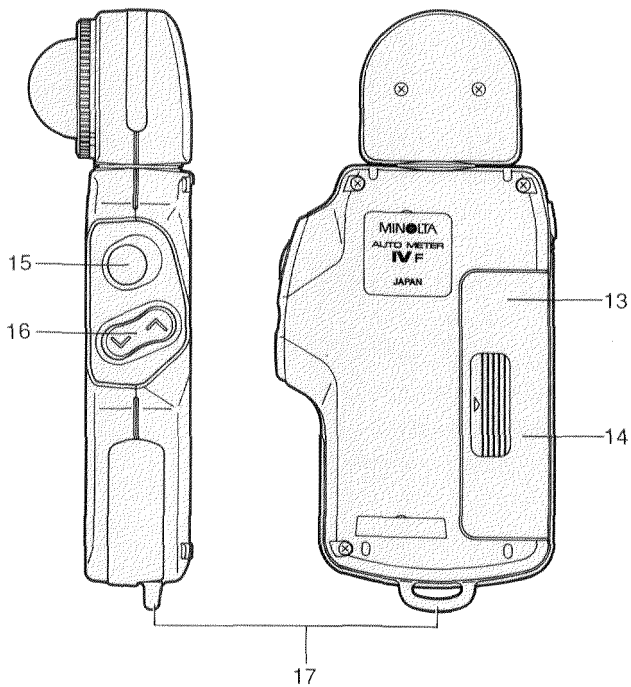

- 13. Measuring-level adjustment screw
adjusts meter calibration
- 14. Battery chamber
- 15. Measuring button
- 16. Up/Down control
adjusts shutter speed and ISO values
- 17. Strap eyelet

DATA PANEL DISPLAYS

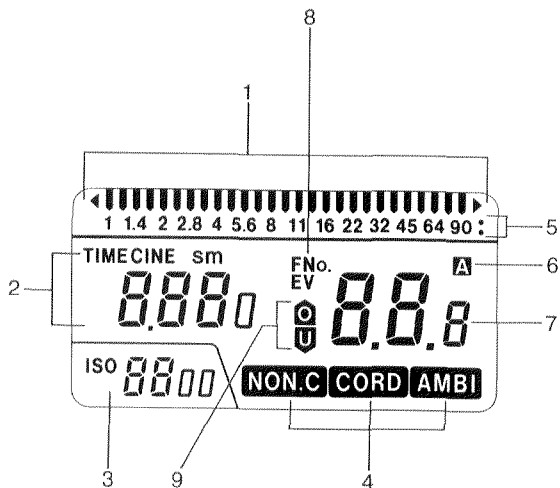

1. Analog scale

displays measured data and memory data simultaneously in 0.5 EV (1/2-stop) increments

2. Shutter-speed/Framing-rate display

displays current shutter speed or framing rate

Display units:

TIME: fractions of seconds

TIME s: whole seconds

TIME m: minutes

CINE: frames per second

3. Film-speed display

displays ISO in 1/3-stop increments

4. *Measuring-mode* indicators

5. Memory indicators

indicate when one or two data are stored in memory

6. Average indicator

appears when average of data or brightness difference is displayed

7. Digital display

displays f/numbers, EV, or brightness difference in 0.1 EV (1/10-stop) increments

8. Display-unit indicator

indicates whether f/number or EV is shown in the digital display

9. Over-/Under-range indicators

indicate when a reading is over/under the meter's display range or sensitivity range

PREPARATIONS

BATTERY

The Auto Meter IV F is powered by a single AA-size, 1.5v alkaline-manganese, carbon-zinc, or 1.2v nickel-cadmium battery.

Installing

1. Remove the battery-chamber cover by sliding it in the direction indicated by the arrow.

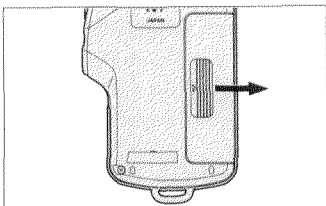

2. Insert the battery with the plus (+) and minus (-) ends oriented according to the diagram in the battery chamber.

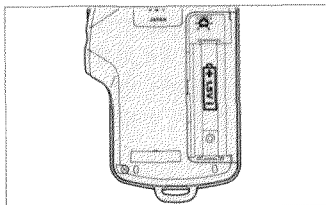

3. Replace the battery-chamber cover.

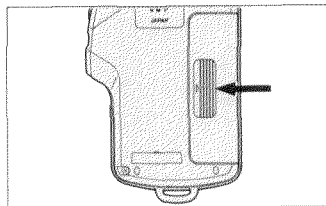

After you install the battery, all of the meter's displays and indicators will light for a few seconds, after which they will be replaced by the display shown at right.

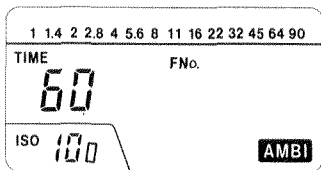

Auto Power Off

To conserve power, the Auto Meter IV F's display automatically switches off if you do not make another reading or press any button for 10 minutes. To restore the display, press the power button. Data in memory and the reading will be erased.

Low-Battery Warning

When the battery's power becomes low, the data panel will blink. When this occurs, replace the old battery with a new one.

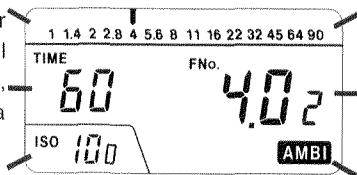

SETTING THE FILM SPEED

The Auto Meter IV F's film speed range is ISO 3 - 8000 in 1/3-stop increments.

1. Press and hold the ISO button.

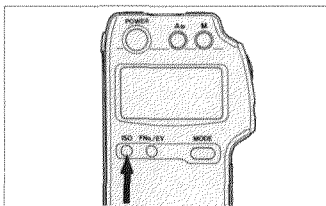

2. Use the up/down control to select the desired ISO value.

- ISO 125 and 1250 will appear in the display as 120 and 1200, respectively.

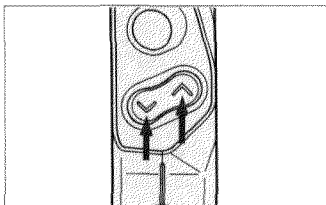

- After you insert a battery, the film speed will be reset to ISO 100.
- If you change the film speed after you take a measurement, the EV or aperture display will change to maintain a correct reading with the new film speed and the selected shutter speed.
- See p.47 for information on how to use the ISO setting to compensate meter readings for filter factors.

SELECTING A MEASURING METHOD

Incident-Light Readings

When you use a meter to make incident-light readings, the exposure is based entirely on the brightness of the light falling on (incident to) your subject. As a result, the subject's reflectance (how dark or light it is)

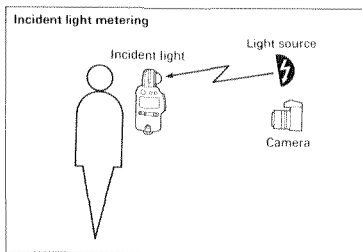

will not influence the meter reading and light and dark tones will reproduce as they appeared in the original scene.

Another advantage of incident-light metering is that the light receptor can be matched to your subject.

For three-dimensional subjects, you should use one of the spherical diffusers; when you photograph flat surfaces such as posters or paintings, use the flat diffuser.

An incident-light reading is the simplest, most convenient method of determining the exposure in a wide variety of situations. It is most effective for scenes which contain a full range of tones, such as in architectural and landscape photographs. Incident-light metering also works well for portrait and other situations where the lighting can be controlled and adjusted to make the contrast range of the scene fit the exposure range of your film.

To take an incident-light reading, attach any of the diffusers (Spherical Diffuser, Flat Diffuser, Mini Diffuser, 4X Spherical ND Diffuser, or 8X Spherical ND Diffuser) to the Auto Meter IV F. Position the meter near your subject, aim the receptor directly at the camera lens, and press the measuring button.

With the Auto Meter IV F, you can also use this measuring method to quickly determine your lighting ratio. See p.38 for more information.

Reflected-Light Readings

When making reflected-light readings, the meter measures and averages the light reflecting from all subjects within its field of view. Like all reflected-light meters, the Auto Meter IV F is calibrated to provide an

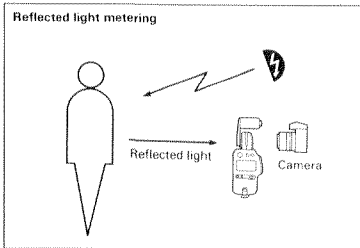

exposure which will reproduce the metered area as a tone with 18% reflectance (zone 5) regardless of its true shade.

With practice, you should be able to pre-visualize how you want various parts of your scene to appear in the final image. You will then be able to take a reflected meter reading of any area and, by adjusting the data provided by the Auto Meter IV F, obtain a correct exposure.*

Reflected readings, together with the meter's brightness-difference function, enables you to quickly and easily determine the brightness range of a scene (see p.41). With this information, you can then adjust the exposure and/or processing to fit your film's exposure range. Reflected-light readings are also useful when you want to meter subjects which emit instead of reflect light.

To make a reflected-light reading, attach the reflected-light attachment, Viewfinder 5 ° or Viewfinder 10 ° II to the meter. Position the receptor head so that it is reading the area you want to meter without casting a shadow on this area or being affected by surrounding parts of the scene or other lights.

- * If, for example, you meter an area which is one stop brighter than zone 5, you will have to increase the metered value by one stop in order to make this area appear with its original brightness. If you meter an area which is one stop darker than zone 5, you will have to decrease the exposure one stop to keep it from appearing brighter than normal. Here again, with practice you will be able to recognize the relative brightness of various shades regardless of their color.

BASIC OPERATION

MEASURING AMBIENT LIGHT

Procedure For Use With A Still Camera

1. Press the power button to turn the meter on.

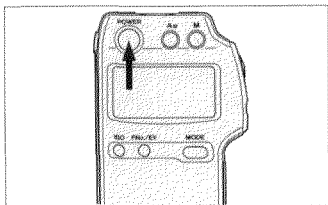

- The most recent settings will appear in the display window.

2. Refer to p.11 and set the desired film speed.

3. If the meter is not set to ambient mode, press the mode button until AMBI appears in the display window.

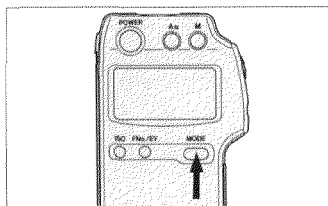

- Any data in the aperture display or in memory will be cleared at this point.

4. Press the display-selector button to set the units in which measured data will be displayed.

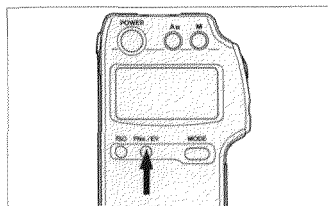

- When the meter is set to display EV numbers, the analog scale and shutter-speed display will not appear.

5. If the meter is set to display f/numbers, use the up/down control to select the desired shutter speed.

- For a still camera, the meter's shutter-speed range is from 1/8000 to 30 sec. in 1/2-stop increments.

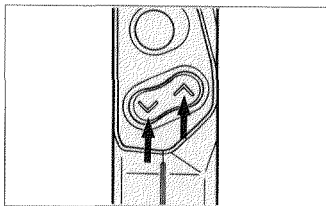

6. Position the meter and press the measuring button.

- The meter will continue to make readings as long as the measuring button is held in. When you release it, the last reading will remain in the digital display. If you selected f/number display, the reading will also be displayed on the analog scale.

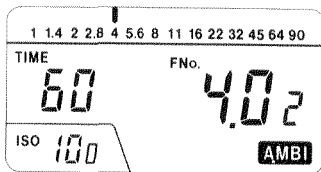
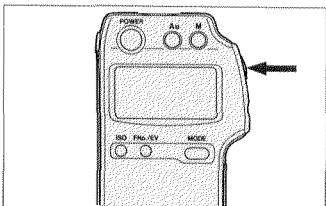

- If the reading is over or under the meter's display range, **FNo.** and **o** (over) or **u** (under) will blink. When this happens, use the up/down control to change the shutter speed and bring the aperture back into the display range. If the reading is over or under the meter's measuring range, **o** or **u** will blink and **E** will appear in the digital display.

Procedure For Use With A Cine Camera

1. Press the power button to turn the meter on.

- The most recent settings will appear in the display window.

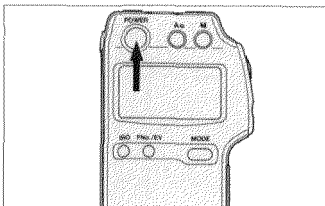

2. Refer to p.11 and set the film speed.

3. If the meter is not already set to *ambient mode*, press the mode button until **AMBI** appears in the display window.

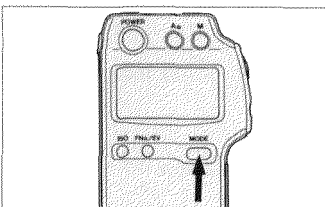

4. Press and hold the up control until the shutter speed display passes 1/8000 sec. and the time units change to **CINE**. Select the framing rate of your camera.

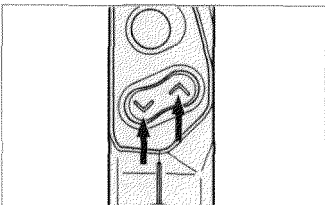

5. If the angle of your camera's shutter is not 180° , the film speed should be adjusted according to the table 1.

Table 1

Shutter opening	Film-speed Adjustment
160°	- 1/3 stop
220°	+1/3 stop

-1/3 stop: press the down control once, e.g., for ISO 100 film, set ISO 80

+1/3 stop: press the up control once, e.g., for ISO 100 film, set ISO 120

6. Position the meter and press the measuring button.

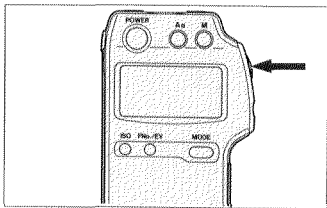

- The meter will continue to make readings as long as the measuring button is held in. When you release it, the last reading will remain in the digital display.

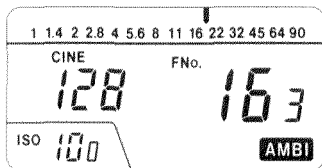

If you selected f/number display, the reading will also be displayed on the analog scale.

- If the reading is over or under the meter's display range, **FNo.** and **o** (over) or **u** (under) will blink. If the reading is over or under the meter's measuring range, **o** or **u** will blink and **E** will appear in the digital display.

MEASURING FLASH LIGHT

With a Sync Cord

1. Press the power button to turn the meter on.

- The most recent settings will appear in the display window.

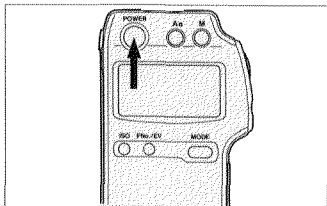

2. Refer to p.11 and set the desired film speed.

3. If the meter is not set to cord mode, press the mode button until **CORD** appears in the display window.

- Any data in the aperture display or in memory will be cleared at this point and the shutter-speed range will change to 1/500 - 1 sec.

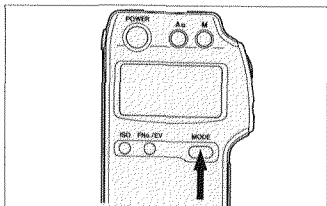

- EV display cannot be selected in cord mode.

4. Use the up/down control to select the X-sync speed of your camera.

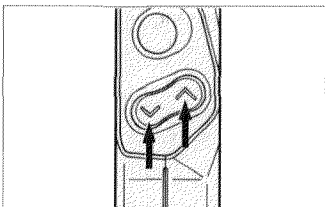

- Shutter speeds between 1/500 and 1 sec can be selected in 1/2-stop increments. Cine speeds cannot be selected in cord mode.

5. Attach the flash sync cord to the meter's sync terminal.

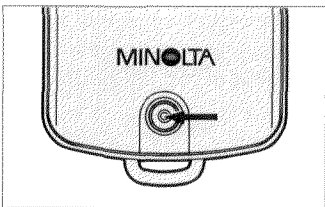

- The flash may fire when you attach the cord.

6. Position the meter and press the measuring button; the flash will fire and the exposure reading will be made.

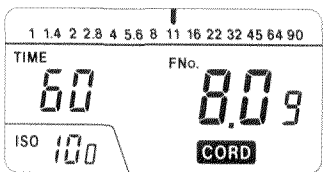
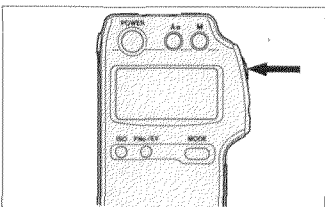

- If the reading is over or under the meter's display range, **FNo.** and **o** (over) or **u** (under) will blink.
- If the reading is over or under the meter's measuring range, **o** or **u** will blink and **E** will appear in the digital display.
- If you change the shutter speed after you make a measurement, the aperture display, analog display, and any data in memory will clear.
- The trigger voltage of some electronic flash units may be too high for the Auto Meter IV F to fire them in cord mode. If this is true of your flash, use non-cord mode (see p. 25).

Without a Sync Cord

1. Press the power button to turn the meter on.

- The most recent settings will appear in the display window.

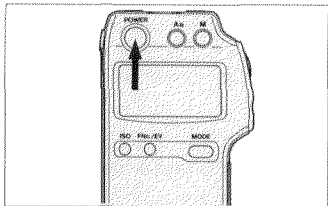

2. Refer to p.11 and set the desired film speed.

3. If the meter is not set to non-cord mode, press the mode button until **NON.C** appears in the display window.

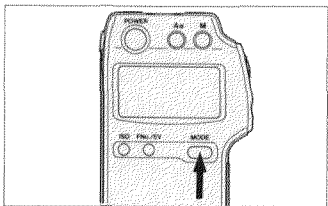

- Any data in the aperture display or in memory will be cleared at this point and the shutter-speed range will change to 1/500 - 1 sec.
- EV display cannot be selected in non-cord mode.

4. Use the up/down control to select the X-sync speed of your camera.

- Shutter speeds between 1/500 and 1 sec. can be selected in 1/2-stop increments. Cine speeds cannot be selected in non-cord mode.

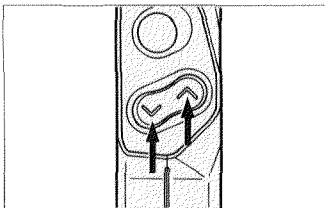

5. Press the meter's measuring button.

- **NON.C** will begin to blink, signaling that the meter is in stand-by, waiting for the flash to fire. The meter will remain in stand-by for one minute. If you press the measuring button again, the meter's internal clock will reset to one minute; if you press any other function button, stand-by will be canceled and that function will be engaged.

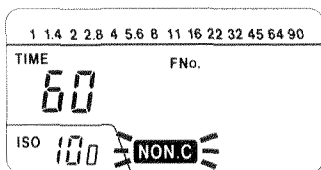

6. Position the meter and fire the flash to make a reading.

- If the reading is over or under the meter's display range, **FNo.** and **o** (over) or **u** (under) will blink. If the reading is over or under the meter's measuring range, **o** or **u** will blink and **E** will appear in the digital display.

SPECIAL FUNCTIONS

MEMORY

To use the Auto Meter IV F's memory, make a reading (flash or ambient) and press the memory button. A dot will appear in the upper right corner of the display window indicating that one value is stored (1).

If you make a second reading, the new data will appear in the digital display and on the analog scale. The value in memory will also remain displayed on the analog scale (2).

If you store this second reading, another memory indicator will appear above the first (3).

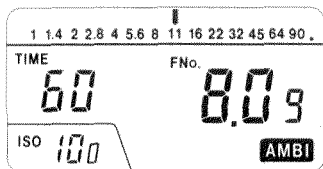
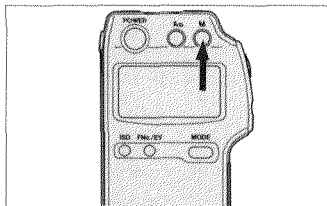

(1)

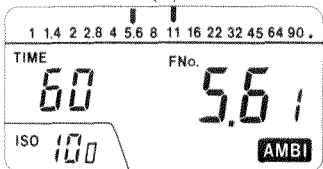

(2)

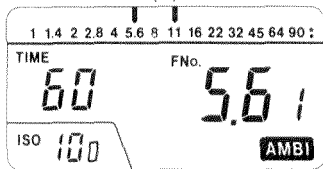

(3)

You may make a third reading--all three will be displayed on the analog scale and the most recent will appear in the digital display (4).

If you press the memory button a third time, the first reading will be replaced by the third (5).

- With only one value in memory, if you make a second reading, you can still recall the original reading to the digital display by pressing the average button.

When **A** appears in the display window, the digital display shows the memory value. If you press the average button again, **A** will disappear and the second reading will return to the digital display.

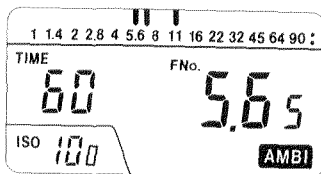

(4)

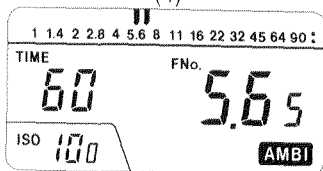

(5)

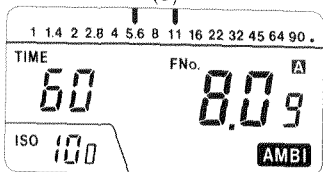

- You may store a reading in memory which is beyond the meter's display range, but not a reading which is beyond the meter's sensitivity range.
- To clear the memory, turn the meter on and off or change the measuring mode.
- Data in memory will be lost if the battery dies or if you change the battery.

AVERAGE

In all measuring modes, to obtain an averaged exposure reading for your subject or scene, first measure and store readings of the highlight and shadow areas of your subject. Next, press the average button.

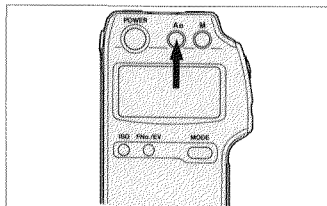

A will appear in the display window and the average of the two readings will appear both in the digital display and on the analog scale.

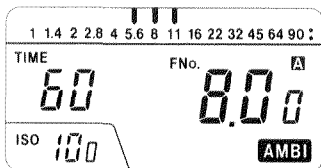

- There must be two data in memory for the meter to calculate an average value.

- If you press and hold the measuring button while **A** appears in the display, the meter will indicate the difference in brightness between the average value and the current light level. See the next section for details. When you release the measuring button, a fourth reading will appear on the analog scale, but the average of the memory data will remain in the digital display. To view this fourth reading digitally, press the average button again. The average indicator and the marker which indicates the average reading on the analog scale will disappear and the digital display will show the most recent reading. Press the average button again to restore the average reading.

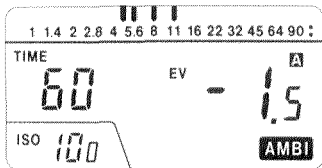

- If you turn the meter off, change the battery, or change the exposure mode, average will be cancelled and the memory will be cleared.

BRIGHTNESS DIFFERENCE

In ambient and cord mode, you can use the Auto Meter IV F to determine the brightness difference between two readings. This feature greatly simplifies adjusting lamp brightness to obtain a desired lighting ratio or determining subject contrast to analyze the brightness range of your scene. See p. 38 - 44 for more information on using this function.

1. Make a reading and press the average button. One memory indicator and **A** will appear in the display.

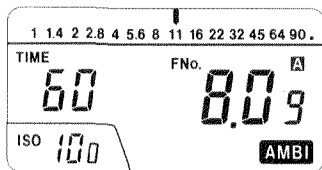

2. Make a second reading of another part of your subject or of another light **and hold the measuring button down.**

- The meter will display the difference between your first reading and the current light level in +/-EV.

When you release the *measuring button*, the digital display will return to the original reading in the units you have selected.

Both readings will be displayed on the analog scale if you selected f/number display.

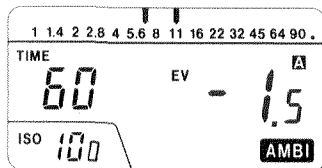

- To display the second reading digitally (in the units you have chosen, not +/-EV), press the average button. **A** will disappear and the second reading will

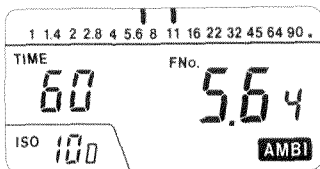

- appear in the digital display. The original reading will remain in memory and both readings will be shown on the analog scale if you have selected f/number display. If you take a reading now, the meter will function normally.
- If two readings are stored, then the brightness difference will be calculated from the average of the two readings.

RE-CALIBRATION

During manufacture, your Auto Meter IV F was precisely calibrated to Minolta standards. No further adjustment of the meter is usually required to obtain optimum results. However, if you want to re-calibrate your meter to match the readings of another meter, the Auto Meter IV F can be adjusted between -0.8 and +0.7 EV.

To adjust the meter, use a small screwdriver to turn the measuring-level adjustment screw located under the battery cover. The marks around the screw show 0.2 EV (1/5-stop) increments and the indents in the screw's rotation represent 0.1 EV (1/10-stop) increments.

- The Auto Meter IV F should be re-calibrated only after you determine that it will not produce the desired results. If you are making only a temporary adjustment, the measuring level adjustment screw should be returned to the zero position as soon as possible after you are finished.

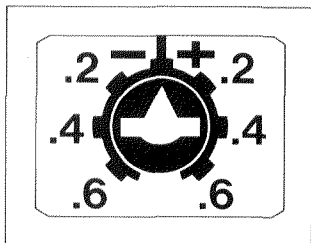

APPLICATIONS

LIGHTING-RATIO MEASUREMENTS

The lighting ratio of a scene is the ratio between the main (key) and fill lights. By adjusting the lighting ratio, you can control the appearance of your subject or the brightness range of your scene.

The Auto Meter IV F, enables you to determine this ratio and to see the difference, in stops on the analog scale or in +/-EV, between light sources, and makes adjusting your lighting to obtain a desired ratio remarkably quick and easy.

1. Attach the flat diffuser to the Auto Meter IV F.
2. Set the film speed, measuring mode, display units, and, if you are reading in f/numbers, the shutter speed to the values you require.
3. Turn on only your main light, position the meter near your main subject, point the receptor directly at the light, and take a reading.

4. Press the average (A) button.

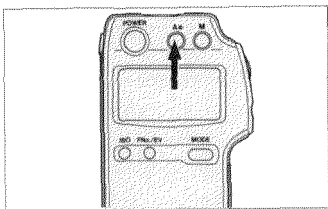

- The reading will be stored in memory and **A** will appear in the display window.

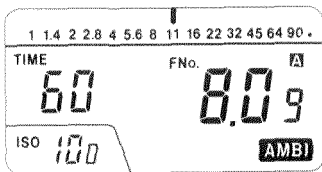

5. Turn on your fill light and turn off the main light.

6. Again position the meter near your main subject and aim the receptor directly at the fill light.

7. Press and hold the measuring button. The meter will display the difference between your main and fill lights in +/-EV. Refer to the table 2 to determine your lighting ratio.

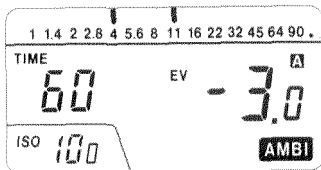

8. If necessary, adjust the brightness and/or distance of the lights until you obtain the ratio you need.

- When you release the measuring button after you make the second reading, if you have selected f/number display, the first reading will reappear in the digital display and both will remain on the analog scale. If you press the average button again so that **A** disappears from the display window, the digital display will show the second reading (in the units you have selected, not +/-EV). The first reading will remain in memory and, if it is the only value in memory, it can be called back by pressing the average button again.
- After you have set the lighting ratio, turn on all your lights and make an exposure reading.

Table 2

+/- EV	Lighting ratio
1	2:1
1.6	3:1
2	4:1
3	8:1
4	16:1
5	32:1
6	64:1

SCENE-CONTRAST MEASUREMENTS

Scene contrast, or brightness range, is the difference between the brightest and darkest parts of your subject or scene. With the Auto Meter IV F's brightness difference function and analog scale, this value is easily measured and converted to a brightness ratio. With this information and the exposure range of your film, you will be able to judge whether your scene will appear as you want it or if its shadows will be blocked-up and highlights washed-out.

The film's exposure range--that is, the difference between the brightest and darkest areas of your scene which will still show detail in the final image--as well as a great deal of useful information can be found in the material packed with the film and in technical publications available from the film manufacturer. In general, color negative film has an exposure range of approximately 7 stops; color slide film, only about 5 stops.

1. Attach the Viewfinder 5° or Viewfinder 10° II to the Auto Meter IV F.
2. Set the film speed, measuring mode, display units, and, if you are reading f/numbers, the shutter speed to the values you require.
3. Turn the receptor head around 180° so that the display window is facing you when you look through the viewfinder.
4. If you are using negative film, first make a reading of the darkest area of your scene in which you want to retain detail; if you are using reversal film, first measure the brightest area in which you want to retain detail.
5. Press the average button.

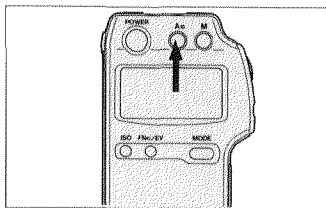

- The reading will be stored in memory and **A** will appear in the display window.

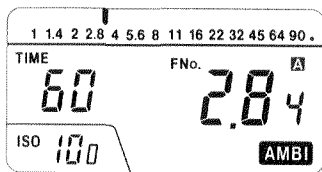

6. Next measure the brightest area (negative film) or darkest area (reversal film) in which you want to retain detail and hold the measuring button down.

- The difference between the first reading and the brightness of the area in the spot circle will appear in the digital display in +/-EV as long as you hold the measuring button down.

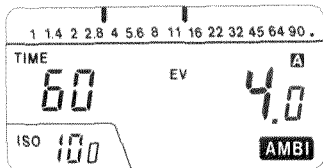

- To determine the scene contrast ratio, refer to the table 3. If necessary, adjust your lighting to bring the scene contrast range within the exposure range of your film, or adjust the development/reproduction variables to alter the exposure range.
- When you release the measuring button, if you have selected f/number display, the first reading will appear both in the digital display and on the analog scale and the last value measured while you were holding the measuring button will be displayed on the analog scale. To display this second reading in the digital display (in the units you have selected, not +/-EV), press the average button again so that **A** disappears from the display window. The first reading will remain in memory and, if there is only one value in memory, it can be recalled by pressing the average button once again.

- If you are in ambient mode and cannot hold the meter steady so that the spot circle remains over the area you are measuring, the brightness-difference reading may change. Set the meter to cord mode. Now when you press the measuring button, the meter will not make continuous measurements. You must still hold the measuring button down after the second reading to view the brightness difference in +/-EV, but the reading will not change if you move the spot circle to an area of different brightness.

Table 3

+/- EV	Scene Contrast
1	2:1
1.6	3:1
2	4:1
3	8:1
4	16:1
5	32:1
6	64:1
7	128:1

USING THE ANALOG SCALE

The Auto Meter IV F's analog scale can help you pre-visualize the placement of midtones, shadows and highlights from your scene in the final image. Based on your own past experience and knowledge of the exposure latitude of your film, this will help you to judge whether the exposure provided by the meter will reproduce the scene as you desire.

Attach Viewfinder 5° or Viewfinder 10° II (5° is preferable) to the Auto Meter IV F and make a reading of:

- the brightest area in which you want to retain detail if you are using reversal film;
- the darkest area in which you want to retain detail if you are using negative film. Store this reading in memory.

Next, measure the darkest (reversal film)/lightest (negative film) area which you want to show detail and place this reading into memory also.

If necessary, adjust the shutter speed to bring both readings onto the analog scale. This is the brightness range of your scene--highlight reading on the right, shadow on the left.

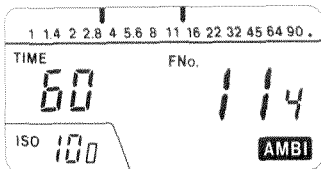

If this brightness range is within the exposure range of your film, press the average button to obtain an exposure reading which will reproduce detail in both of the areas you measured. Of course if the brightness range is smaller than the exposure range, then you may have detail in areas darker and lighter than those you measured. Adjust your exposure, development, and/or reproduction variables to obtain the results you want.

If, however, the brightness range is greater than the film's exposure range, you will have to adjust one or all of the variables listed above, change the lighting conditions if you have control over them, or you may have to settle for a loss of detail in the highlights and/or shadows.

In the second case, it may be useful to take a reflected reading of a grey card (zone 5). You will then be able to see the position of your highlight and shadow readings and calculated average value with respect to the meter reading of a standard midtone. Remember, when you take a reflected-light reading, the exposure provided by the meter will make the area you read appear as a Zone 5 after normal development.

FILTER-FACTOR CORRECTION

When you place filters over the camera lens, you will have to increase the exposure which is indicated by the Auto Meter IV F. Calculating this increase and adding it to the meter reading can be a laborious procedure if you are making more than one exposure at different shutter speed and aperture settings or if you are using several filters simultaneously.

With the Auto Meter IV F's wide ISO range, you can add the filter factor directly to the film speed setting so that the meter will automatically compensate for the light absorbed by the filters and display the correct exposure.

1. First, determine the filter factor of each filter you will be using.
 - This is generally expressed in 1/3-stops on the filter, in its accompanying technical literature, or on the outside of the filter packaging.
2. If you are using more than one filter, add all the factors together to obtain a correction factor for the entire filter pack.
3. Decrease the meter's film speed by this number of stops.

For example, if you are using two filters, one with a filter factor of $2/3$ and the other with a factor of $1\ 2/3$, the filter factor of the two together is $2\ 1/3$ ($2/3 + 1\ 2/3 = 1\ 4/3$ or $2\ 1/3$). To add this compensation value to the meter's operation, press and hold the ISO button and press the down control 7 times (6 times for the 2 whole-stops plus once more for the additional $1/3$ -stop). If you are using ISO 100 film, the meter should now read ISO 20. Now, each time you take a meter reading, the Auto Meter IV F will automatically compensate for the light absorbed by the two filters.

ILLUMINANCE MEASUREMENTS

The Auto Meter IV F provides you with the means to determine the illuminance, in lux (lx), of an ambient light source.

1. Attach the flat diffuser to the Auto Meter IV F.
2. Turn the meter on, select ambient mode, set the film speed to ISO 100, and set the digital display to EV.
3. Position the meter so that it is near your subject, point the receptor head directly at the light source you are measuring, and press the measuring button to take a reading.
4. Use the EV indicated by the meter and refer to the table 4 to determine the illuminance. Find the integer value of the meter reading in the left-hand column and the decimal value in the top row. Where the row and column intersect is the approximate illuminance measurement in lux.

For example, if the meter displays a reading of EV 10.7, the row for the integer 10 and the column for the decimal 0.7 intersect at 4200 lx.

- Illuminance can also be calculated using the following formula:

$$\text{lx} = 2.5 \times 2^{\text{EV}}$$

- For precise measurements of illuminance, use the Minolta Illuminance Meter.

Table 4 (EV - Ix conversion table, ISO 100)

Decimal Integral	.0	.1	.2	.3	.4	.5	.6	.7	.8	.9
-2	0.63	—	—	—	—	—	—	—	—	—
-1	1.3	1.2	1.1	1.0	0.9	0.9	0.8	0.8	0.7	0.7
-0	2.5	2.3	2.2	2.0	1.9	1.8	1.7	1.5	1.4	1.3
+0	2.5	2.7	2.9	3.1	3.3	3.5	3.8	4.1	4.4	4.7
1	5.0	5.4	5.7	6.2	6.6	7.1	7.6	8.1	8.7	9.3
2	10	11	12	12	13	14	15	16	17	19
3	20	21	23	25	26	28	30	33	35	37
4	40	43	46	49	53	57	61	65	70	75
5	80	86	92	99	110	110	120	130	140	150
6	160	170	180	200	210	230	240	260	280	300
7	320	340	370	390	420	450	490	520	560	600
8	640	690	740	790	840	910	970	1000	1100	1200
9	1300	1400	1500	1600	1700	1800	1900	2100	2200	2400
10	2600	2700	2900	3200	3400	3600	3900	4200	4500	4800
11	5100	5500	5900	6300	6800	7200	7800	8300	8900	10000
12	10000	11000	12000	13000	14000	15000	16000	17000	18000	19000
13	21000	22000	24000	25000	27000	29000	31000	33000	36000	38000
14	41000	44000	47000	50000	54000	58000	62000	67000	71000	76000
15	82000	88000	94000	100000	110000	120000	120000	130000	140000	150000
16	160000	180000	190000	200000	220000	230000	250000	270000	290000	310000
17	330000	350000	380000	400000	430000	460000	500000	530000	570000	610000
18	660000	700000	750000	810000	860000	930000	990000	1100000	1100000	1200000

ACCESSORIES

Viewfinder 5° /Viewfinder 10° II

These finders attach to the Auto Meter IV F and allow it to make reflected-light measurements. With the Viewfinder 5° , the angle of acceptance is 5° ; with the Viewfinder 10° II, the angle of acceptance is 10° .

The meter can thus be used to accurately spot-measure exposure for parts of a subject or scene, or within the approximate angle of view of certain telephoto lenses.

40° reflected-light attachment

With an approximately 40° angle of acceptance, this attachment permits taking reflected-light measurements which correspond to the field of view of most normal lenses.

Flat Diffuser

With this diffuser attached, the Auto Meter IV F can be used to measure exposure for flat subjects, illuminance value of light, lighting ratio between light sources.

Mini Receptor

This small remote receptor plugs into the head of the Auto Meter IV F to provide 12mm-diameter measurement of incident light in otherwise inaccessible positions. It is particularly useful for close-ups and photomacrography.

4X and 8X Spherical ND Diffusers

Both of these spherical diffusers incorporate a neutral density element, and are used when light is too bright to be measured normally. With the 4X diffuser, the meter's upward range is extended by two stops(2 EV); with the 8X, by three stops(3 EV). Operation of the meter remains the same as with the standard spherical diffuser.

Spot Mask

This mask attaches to the meter in place of the standard diffuser. It enables the Auto Meter IV F to be used in the darkroom for calculating enlarging exposure data.

Sync Cord II

This Sync Cord II is a 5-meter long cord that connects the meter, flash unit, and camera's sync terminal together. Using this cord, you can take flash readings and release the shutter without changing connections.

Booster II

When plugged into the accessory-receptor jack on the head of the Auto Meter IV F, this separate sensor enables making accurate measurements of brightness at an SLR eyepiece, on an SLR focusing screen or view camera groundglass, through the eyepiece of a microscope, or at the film plane of a full-frame 35mm camera. The Booster II may also be used for ordinary direct reflected-light measurement, with an approximately 60° angle of acceptance.

CARE AND STORAGE

- Do not press on or damage the indication-display windows.
- Do not subject the meter to shock or vibration.
- This meter is designed for use at temperatures 50°C and -10°C . If the unit becomes hotter or colder than this, operation may be unsatisfactory.
- The meter should never be placed or left in the glove compartment or other places in a motor vehicle, or elsewhere, where it may be subject to temperatures higher than 55°C , or lower than -20°C , as it may be permanently damaged. Particular care should be taken not to leave the meter in sunlight or near sources of heat such as strong lights, etc. Do not store it in humid places, or near corrosive chemicals.
- If the meter is left or placed in direct sunlight for any long period, the indication-display window will turn black.
- When the meter is to be stored, place it in its original packing, and put it in an air-tight container with an appropriate amount of dehumidifying agent, such as silica gel.

- Never attempt to disassemble the meter. Any repairs necessary should be undertaken only by an authorized Minolta service facility.
- The meter body may be wiped with a silicone-treated cloth to clean it. Do not allow alcohol or chemicals of any other kind to touch its surface.
- Never lubricate any part of the meter.
- If the meter is not to be used for two or more weeks, it is advisable to remove the battery.

SPECIFICATIONS

Type:

Hand-held exposure meter for measuring ambient and flash light

Receptor:

Silicon photocell on 270°-rotating receptor head

Reception Method:

Incident: cardioid spherical diffuser, flat diffuser, 4X spherical ND diffuser, 8X spherical ND diffuser

Reflected: Viewfinder 5° Viewfinder 10° II, 40° Reflected-light attachment

External receptor: Booster II, Mini Receptor

Measuring Modes:

Ambient (AMBI), flash (CORD, NON.C)

Ambient Range (at ISO 100):

Incident: EV -2.0 - 19.9

Reflected: Viewfinder 5° EV 2.5 - 24.4 ; Viewfinder 10° II
IEV 1.2 - 23.1; 40° Reflected-light attachment
EV 1.2 - 23.1

Flash Range (at 1/60 sec., ISO 100):

Incident: f/1.0 - 90+0.9

Reflected: Viewfinder 5° f/1.0 - 90+0.9; Viewfinder 10° II
f/1.0 -90+0.9; Reflected-light attachment f/1.0 -
90+0.9

Display Screen:

Liquid crystal (LCD)

Display Range:

ISO: 3 - 8000 in 1/3-stop increments

Shutter speed (ambient): 1/8000 sec. - 30 min. in 1/2-stop increments

Shutter speed (flash): 1/500 - 1 sec. in 1/2-stop increments

Framing rate: 8 - 128 frames/sec.

f/no.: 1/0 - 90+0.9 in 1/10-stop increments

EV: -7.8 - 31.5 in 1/10-stop increments

Brightness difference: -9.9 - +9.9 in 1/10-stop increments

Analog scale (f/no.): 1.0 - 90 in 1/2-stop increments

Other Displays:

Over-/under-range, memory 1, memory 2, average

Additional Functions:

Memory: 2-channel

Average: average of data in memory

Power Source:

One AA battery

Dimensions:

147 x 59 x 26mm; 5-3/4 X 2-5/16 X 1 in.

Weight (without battery):

125g; 4.4 oz.

Other:

Accessory-receptor jack, data adjustment (-0.8 - +0.7 EV), SYNC terminal

Specifications subject to change without notice

INTRODUCTION

L'Auto Mètre IV F Minolta est un appareil qui vous permettra de résoudre facilement tous vos problèmes de mesure de lumière.

Il offre bien sûr toutes les fonctions de base d'un flashmètre/posemètre: modes lumière continue, flash avec cordon ou sans cordon, calcul d'une moyenne, et mémorisation de deux valeurs.

De plus, des caractéristiques telles que vitesse de synchro réglable entre 1/500 à 1 sec. , calcul d'une différence de luminosité, plage de sensibilité de film étendue, ou encore affichage digital et analogique, vous permettront de tirer parti au mieux de l'Auto Mètre IV F dans pratiquement n'importe quelle situation d'éclairage.

Vous pourrez ainsi mieux vous concentrer sur la composition de vos photographies.

Avant que vous ne commenciez, un petit mot sur ce manuel.

Il se compose de plusieurs chapitres afin que vous trouviez directement les informations dont vous avez besoin.

L'apprentissage de l'utilisation de votre posemètre sera ainsi plus simple.

Avant tout, lisez les deux premières parties, intitulées *Nomenclature et affichage et Opérations préliminaires*.

Toute la partie *Fonctionnement de base* vous explique comment réaliser des mesures en lumière continue et flash.

Ensuite, le chapitre *Fonctions spéciales* vous expliquera le fonctionnement des différentes fonctions supplémentaires de l'Auto Mètre IV F.

Enfin, vous trouverez dans la partie intitulée *Applications*, de nombreux renseignements sur les possibilités d'utilisation de ces fonctions: ces informations vous permettront d'exploiter au mieux tout le potentiel de votre Auto Mètre IV F.