

®
MACKIE

1402-VLZ PRO 14-CHANNEL MIC/LINE MIXER OWNER'S MANUAL

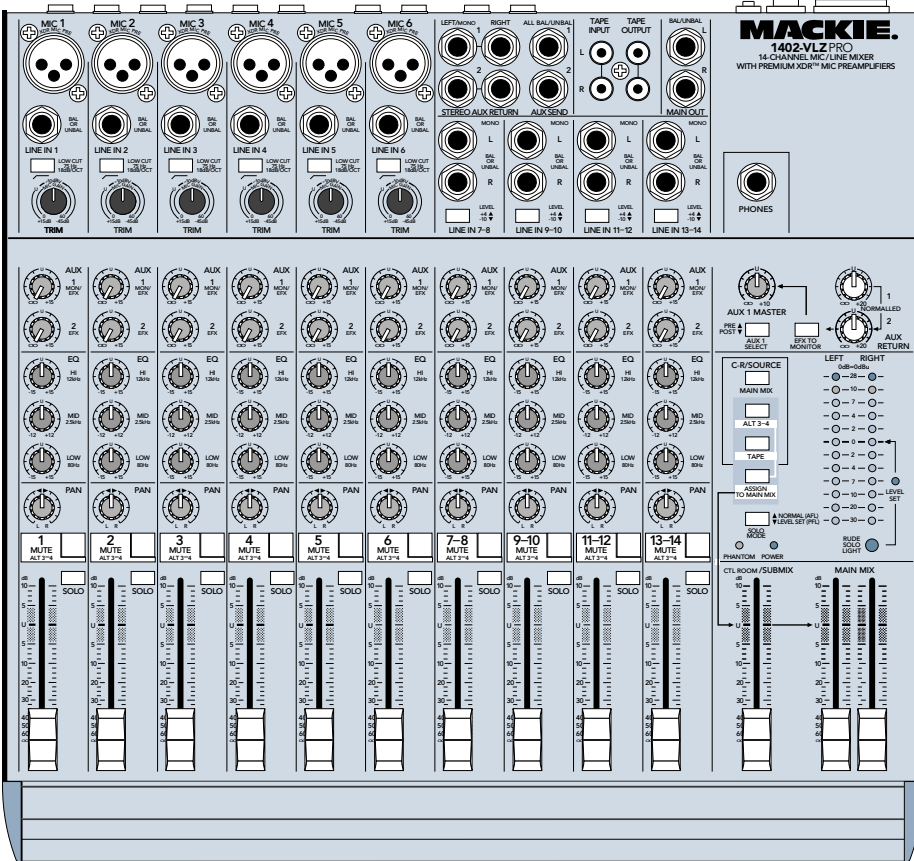

<div style="display: inline-block; text-align: center; background-color: black; color: white; padding: 2px 10px; font-weight: bold; font-size: 1.2em;">CAUTION AVIS</div>
RISK OF ELECTRIC SHOCK DO NOT OPEN RISQUE DE CHOC ELECTRIQUE NE PAS OUVRIR
CAUTION: TO REDUCE THE RISK OF ELECTRIC SHOCK DO NOT REMOVE COVER (OR BACK) NO USER-SERVICEABLE PARTS INSIDE REFER SERVICING TO QUALIFIED PERSONNEL ATTENTION: POUR EVITER LES RISQUES DE CHOC ELECTRIQUE, NE PAS ENLEVER LE COUVERCLE. AUCUN ENTRETIEN DE PIECES INTERIEURES PAR L'USAGER. CONFIER L'ENTRETIEN AU PERSONNEL QUALIFIE. AVIS: POUR EVITER LES RISQUES D'INCENDIE OU D'ELECTROCUTION, N'EXPOSEZ PAS CET ARTICLE A LA PLUIE OU A L'HUMIDITE

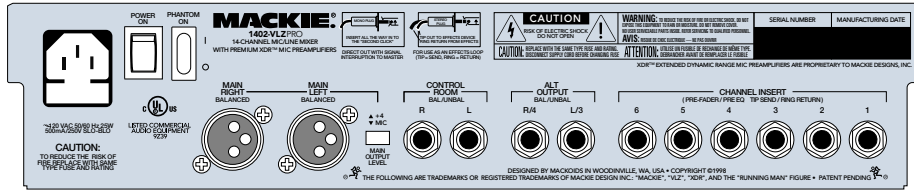

The lightning flash with arrowhead symbol within an equilateral triangle is intended to alert the user to the presence of uninsulated "dangerous voltage" within the product's enclosure, that may be of sufficient magnitude to constitute a risk of electric shock to persons.
Le symbole éclair avec point de flèche à l'intérieur d'un triangle équilatéral est utilisé pour alerter l'utilisateur de la présence à l'intérieur du coffret de "voltage dangereux" non isolé d'ampleur suffisante pour constituer un risque d'électrocution.



The exclamation point within an equilateral triangle is intended to alert the user of the presence of important operating and maintenance (servicing) instructions in the literature accompanying the appliance.
Le point d'exclamation à l'intérieur d'un triangle équilatéral est employé pour alerter les utilisateurs de la présence d'instructions importantes pour le fonctionnement et l'entretien (service) dans le livret d'instruction accompagnant l'appareil.

SAFETY INSTRUCTIONS

- 1. Read Instructions** — All the safety and operation instructions should be read before this Mackie product is operated.
- 2. Retain Instructions** — The safety and operating instructions should be kept for future reference.
- 3. Heed Warnings** — All warnings on this Mackie product and in these operating instructions should be followed.
- 4. Follow Instructions** — All operating and other instructions should be followed.
- 5. Water and Moisture** — This Mackie product should not be used near water — for example, near a bathtub, washbowl, kitchen sink, laundry tub, in a wet basement, near a swimming pool, swamp or salivating St. Bernard dog, etc.
- 6. Cleaning** — Clean only with a dry cloth.
- 7. Ventilation** — This Mackie product should be situated so that its location or position does not interfere with its proper ventilation. For example, the Component should not be situated on a bed, sofa, rug, or similar surface that may block any ventilation openings, or placed in a built-in installation such as a bookcase or cabinet that may impede the flow of air through ventilation openings.
- 8. Heat** — This Mackie product should be situated away from heat sources such as radiators, or other devices which produce heat.
- 9. Power Sources** — This Mackie product should be connected to a power supply only of the type described in these operation instructions or as marked on this Mackie product.
- 10. Power Cord Protection** — Power supply cords should be routed so that they are not likely to be walked upon or pinched by items placed upon or against them, paying particular attention to cords at plugs, convenience receptacles, and the point where they exit this Mackie product.
- 11. Object and Liquid Entry** — Care should be taken so that objects do not fall on, and liquids are not spilled into, this Mackie product.

12. Damage Requiring Service — This Mackie product should be serviced only by qualified service personnel when:

- A.** The power-supply cord or the plug has been damaged; or
- B.** Objects have fallen, or liquid has spilled into this Mackie product; or
- C.** This Mackie product has been exposed to rain; or
- D.** This Mackie product does not appear to operate normally or exhibits a marked change in performance; or
- E.** This Mackie product has been dropped, or its chassis damaged.

13. Servicing — The user should not attempt to service this Mackie product beyond those means described in this operating manual. All other servicing should be referred to the Mackie Service Department.

14. To prevent electric shock, do not use this polarized plug with an extension cord, receptacle or other outlet unless the blades can be fully inserted to prevent blade exposure.

Pour prévenir les chocs électriques ne pas utiliser cette fiche polarisée avec un prolongateur, un prise de courant ou une autre sortie de courant, sauf si les lames peuvent être insérées à fond sans laisser aucune partie à découvert.

15. Grounding or Polarization — Precautions should be taken so that the grounding or polarization means of this Mackie product is not defeated.

16. Power Precautions — Unplug this Mackie product during lightning storms or when unused for long periods of time. Note that this Mackie product is not completely disconnected from the AC mains service when the power switch is in the OFF position.

17. This apparatus does not exceed the Class A/Class B (whichever is applicable) limits for radio noise emissions from digital apparatus as set out in the radio interference regulations of the Canadian Department of Communications.

ATTENTION — Le présent appareil numérique n'émet pas de bruits radioélectriques dépassant les limites applicables aux appareils numériques de class A/de class B (selon le cas) prescrites dans le règlement sur le brouillage radioélectrique édicté par les ministères des communications du Canada.

18. Exposure to extremely high noise levels may cause permanent hearing loss. Individuals vary considerably in susceptibility to noise-induced hearing loss, but nearly everyone will lose some hearing if exposed to sufficiently intense noise for a period of time. The U.S. Government's Occupational Safety and Health Administration (OSHA) has specified the permissible noise level exposures shown in the following chart.

According to OSHA, any exposure in excess of these permissible limits could result in some hearing loss. To ensure against potentially dangerous exposure to high sound pressure levels, it is recommended that all persons exposed to equipment capable of producing high sound pressure levels use hearing protectors while the equipment is in operation. Ear plugs or protectors in the ear canals or over the ears must be worn when operating the equipment in order to prevent a permanent hearing loss if exposure is in excess of the limits set forth here.

Duration Per Day In Hours	Sound Level dBA, Slow Response	Typical Example
8	90	Duo in small club
6	92	
4	95	Subway Train
3	97	
2	100	Very loud classical music
1.5	102	
1	105	Tami screaming at Adrian about deadlines
0.5	110	
0.25 or less	115	Loudest parts at a rock concert

WARNING — To reduce the risk of fire or electric shock, do not expose this appliance to rain or moisture.

READ THIS PAGE!!!

We realize that you must be dying to try out your new Mackie 1402-VLZ PRO. Or you might be one of those people that never read manuals. Either way, all we ask is that you read this page NOW, and the rest can wait until you're good and ready. But do read it — you'll be glad you did.

1 LEVEL-SETTING PROCEDURE

Message to seasoned pros: *do not* set levels using the old “Turn the trim up until the clip light comes on, then back off a hair” trick. When a Mackie Designs mixer clip light comes on, you really are about to clip. We worked and slaved to come up with a better system, one that provides low noise and high headroom.

Adjusting input levels (Channels 1–6 only)

On the first six channels, it's not even necessary to hear what you're doing to set optimal levels. But if you'd like to: Plug headphones into the PHONES jack, then set the CTL ROOM/SUBMIX fader about one quarter of the way up.

The following steps must be performed one channel at a time:

1. Turn the TRIM, AUX SEND and FADER controls fully down.
2. Set the EQ knobs at the center detent.
3. Connect the signal source to the input.
4. Engage (push in) the SOLO switch.
5. Engage the AFL/PFL switch in the master section. A green LEVEL SET light will congratulate you.
6. Play something into the selected input. This could be an instrument, a singing or speaking voice, or a line input such as a CD player or tape recorder output. Be sure that the volume of the input is the same as it would be during normal use. If it isn't, you might have to readjust these levels during the middle of the set.
7. Adjust the channel's TRIM control so that the display on the LED meters stays around “0” and never goes higher than “+7.”
8. If you'd like to apply some EQ, do so now and return to step 7.
9. Disengage that channel's SOLO switch.
10. Repeat for each of Channels 1–6.

Other Nuggets of Wisdom

For optimum sonic performance, the channel and MAIN MIX FADERS should be set near the “U” (unity gain) markings.

Always turn the MAIN MIX and CTL ROOM/SUBMIX faders down before making connections to and from your 1402-VLZ PRO.

If you shut down your equipment, turn off your amplifier(s) first. When powering up, turn on your amplifier(s) last.

Save the shipping box! You may need it someday, and you don't want to have to pay for another one.



INSTANT MIXING

Here's how to get going right away, assuming you own a microphone and a keyboard:

1. Plug your microphone into Channel 1's MIC IN.
2. Turn on the 1402-VLZ PRO.
3. Perform the **Level Setting Procedure 1**.
4. Connect cords from the MAIN OUTPUTS (XLR, ¼" or RCA, your choice) to your amplifier.
5. Hook up speakers to the amp and turn it on.
6. Turn up the 1402-VLZ PRO's Channel 1 FADER to the “U” marking and the MAIN MIX fader one quarter of the way up.
7. Sing like a canary!
8. Plug your keyboard into stereo channel 7–8.
9. Slide that channel's FADER to the “U” marking.
10. Play like a madman *and* sing like a canary! It's your first mix!

Please write your serial number here for future reference (i.e. insurance claims, tech support, return authorization, etc.):

Purchased at:

Date of purchase:

INTRODUCTION

Thank you for choosing a Mackie Designs professional compact mixer. The 1402-VLZ PRO is equipped with our new precision-engineered XDR™ Extended Dynamic Range premium studio-grade mic preamp featuring:

- Full gain range from 0 to 60dB
- +22 dBu line signal handling capability
- 130 dB dynamic range
- Distortion less than 0.0007%, 20Hz to 20kHz
- Bullet-proof RF rejection using DC pulse transformer circuitry

Now that you have your 1402-VLZ PRO, find out how to get the most from it. That's where this manual comes in.

HOW TO USE THIS MANUAL

Since many of you folks will want to hook up your 1402-VLZ PRO immediately, the first pages you will encounter after the table of contents are the everpopular hookup diagrams. These show typical mixer setups for Record/Mixdown, Video, Disc Jockey and Stereo PA. After this section is a detailed tour of the entire mixer.

Every feature of the 1402-VLZ PRO is described “geographically;” in other words, in order of where it is physically placed on the mixer’s top or rear panel. These descriptions are divided into the first three manual chapters, just as your mixer is organized into three distinct zones:

1. PATCHBAY: Along the top and back.
2. CHANNEL STRIP: The ten channel strips on the left.
3. OUTPUT SECTION: The section on the right.

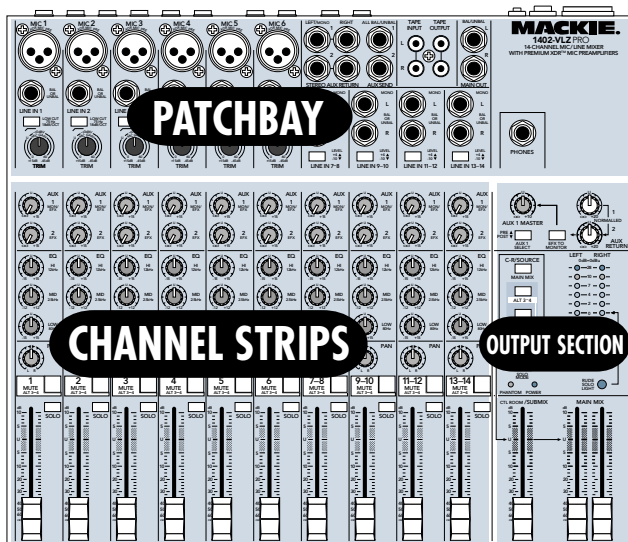

Throughout these chapters you'll find illustrations, with each feature numbered. If you're curious about a feature, simply locate it on the appropriate illustration, notice the number attached to it, and find that number in the nearby paragraphs.

You'll also find cross-references to these numbered features within a paragraph. For instance, if you see “*To wire your own cables: 5,*” simply find that number in the manual and you've found your answer.

Finally, you'll notice feature numbers like this: 26. These numbers direct you to relevant information.



This icon marks information that is critically important or unique to the 1402-VLZ PRO. For your own good, read them and remember them. They will be on the final test. And the final test score will go down on your Permanent Record.



This icon will lead you to in-depth explanations of features and practical tips. While not mandatory, they usually have some valuable nuggets of information.

A PLUG FOR THE CONNECTORS SECTION

Appendix A is a section on connectors: XLR connectors, balanced connectors, unbalanced connectors, special hybrid connectors.

More resources on our website @ www.mackie.com

THE GLOSSARY: A Haven of Non-Techiness For The Neophyte

The "Glossary of Terms" is a fairly comprehensive dictionary of pro-audio terms. If terms like “clipping,” “noise floor,” or “unbalanced” leave you blank, refer to this glossary for a quick explanation.

ARCANE MYSTERIES ILLUMINATED

"Arcane Mysteries" discusses some of the down 'n' dirty practical realities of microphones, fixed installations, grounding, and balanced versus unbalanced lines. It's a goldmine for the neophyte and even the seasoned pro might learn a thing or two.

CONTENTS

1	LEVEL-SETTING PROCEDURE	3
2	HOOKUP DIAGRAMS	6
3	1402-VLZ PRO PATCHBAY DESCRIPTION	10
4	MIC INPUTS	10
5	PHANTOM POWER	10
6	LINE INPUTS	11
7	LOW CUT	11
8A	TRIM	11
8B	+4 / -10	11
9	STEREO LINE INPUTS	12
10	EFFECTS: SERIAL OR PARALLEL?	12
11	INSERT	13
12	AUX RETURNS	13
13	TAPE IN	14
14	XLR MAIN OUTPUTS	14
15	MAIN OUTPUT LEVEL	15
16	1/4" MAIN OUTPUTS	15
17	TAPE OUTPUT	15
18	PHONES	16
19	ALT 3-4 OUTPUT	16
20	CONTROL ROOM	16
21	AUX SEND 1 & 2	16
22	POWER CONNECTION	17
23	FUSE	17
24	POWER SWITCH	17
25	PHANTOM SWITCH	17
26	CHANNEL STRIP DESCRIPTION	18
27	"U" LIKE UNITY GAIN	18
28	FADER	18
29	SOLO	18
30	MUTE/ALT 3-4	18
31	PAN	19
32	CONSTANT LOUDNESS !!!	19
33	3-BAND EQ	19
34	AUX SEND	20
35	OUTPUT SECTION DESCRIPTION	21
36	MAIN MIX	21
37	VLZ MIX ARCHITECTURE	21
38	SOURCE MATRIX	21
39	CONTROL ROOM / SUBMIX	22
40	SOLO MODE: AFL / PFL	22
41	RUDE SOLO LED	22
42	ASSIGN TO MAIN MIX	23
43	METERS	23
44	AUX TALK	24
45	AUX 1 SELECT	24
46	AUX 1 MASTER	24
47	AUX RETURNS	24
48	EFX TO MONITOR	25
49	JACK NORMALLING	25
50	MODIFICATIONS	25
51	1402-VLZ PRO BLOCK DIAGRAM	26
52	GAIN STRUCTURE DIAGRAM	27
53	SPECIFICATIONS	28
54	SERVICE INFO	29
	APPENDIX A: CONNECTIONS	30
	TRACK SHEET	33
	COLOPHON	34
	1402-VLZ PRO LIMITED WARRANTY	35

2 HOOKUP DIAGRAMS

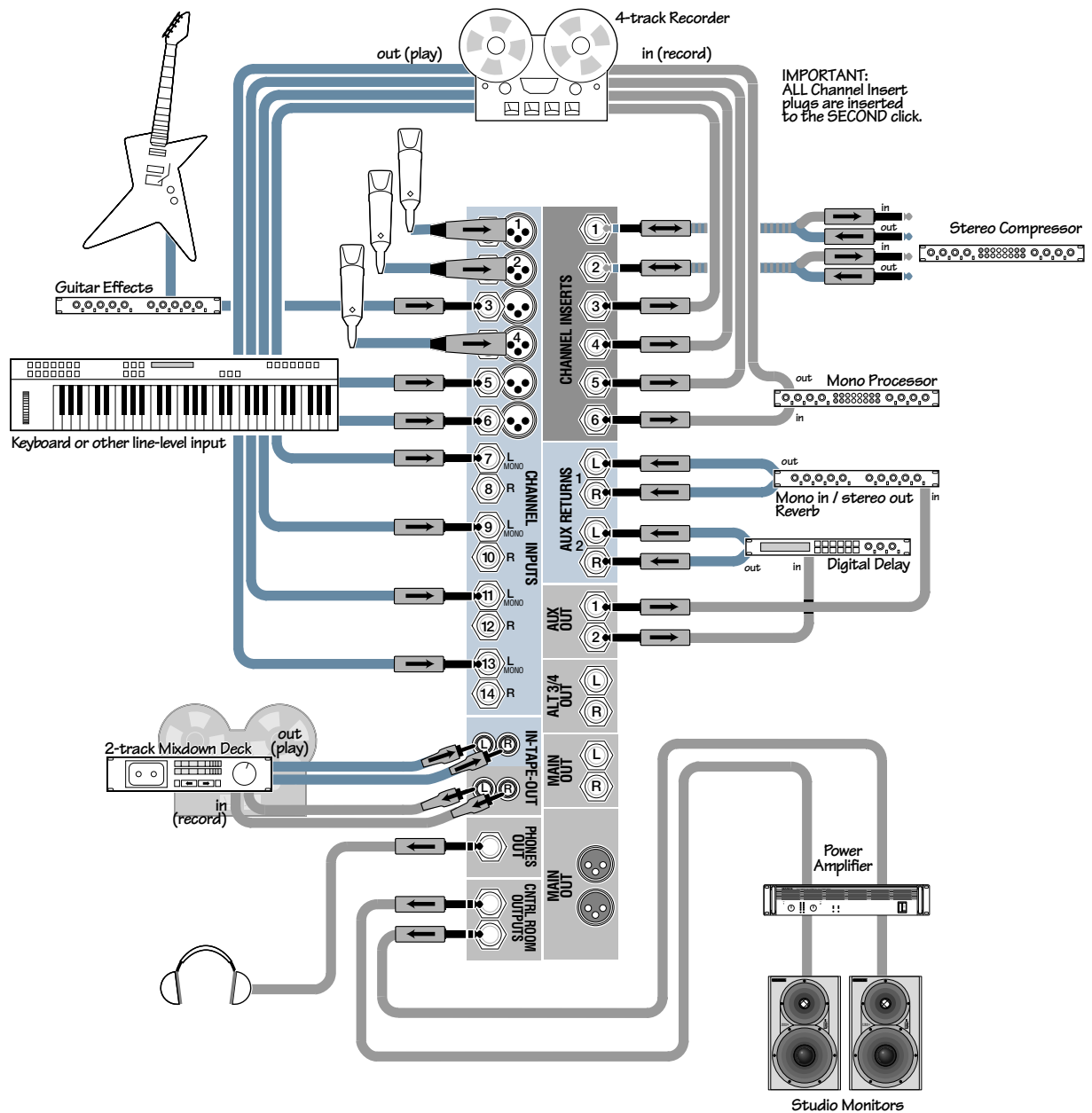

1402-VLZ PRO 4-Track Record / 2-Track Mix

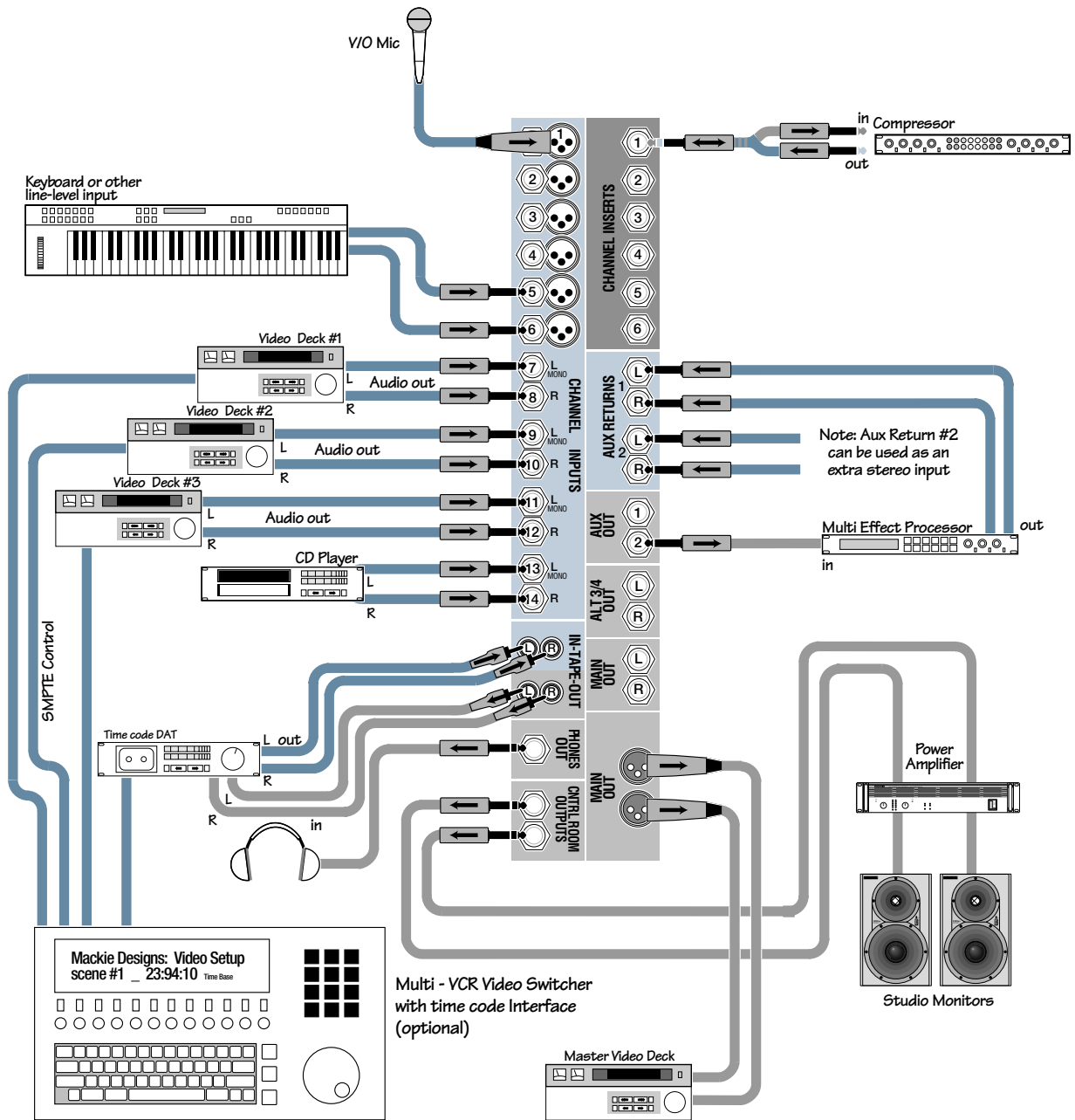

1402-VLZ PRO Video Setup

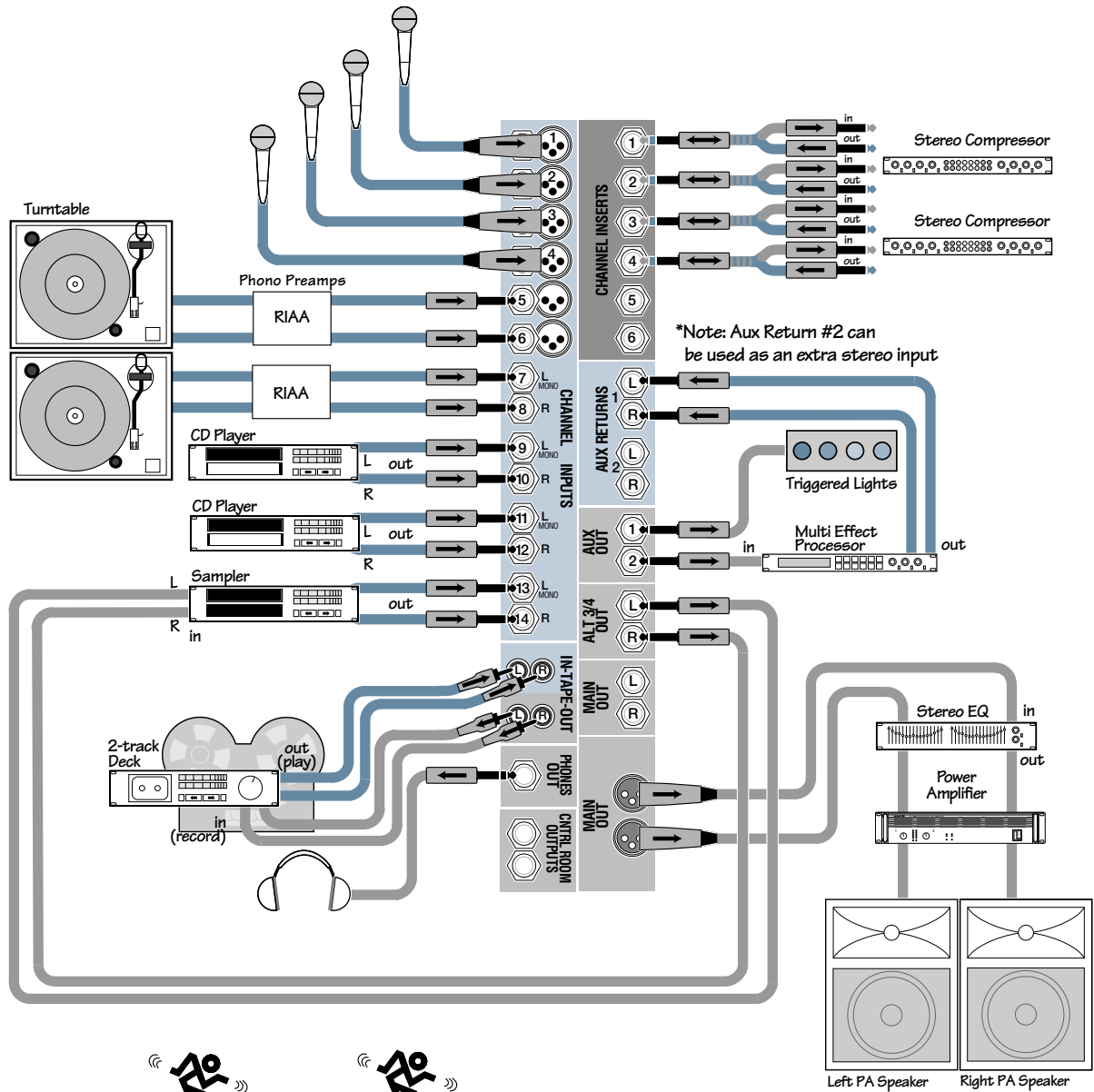

1402-VLZ PRO Disc Jockey Setup

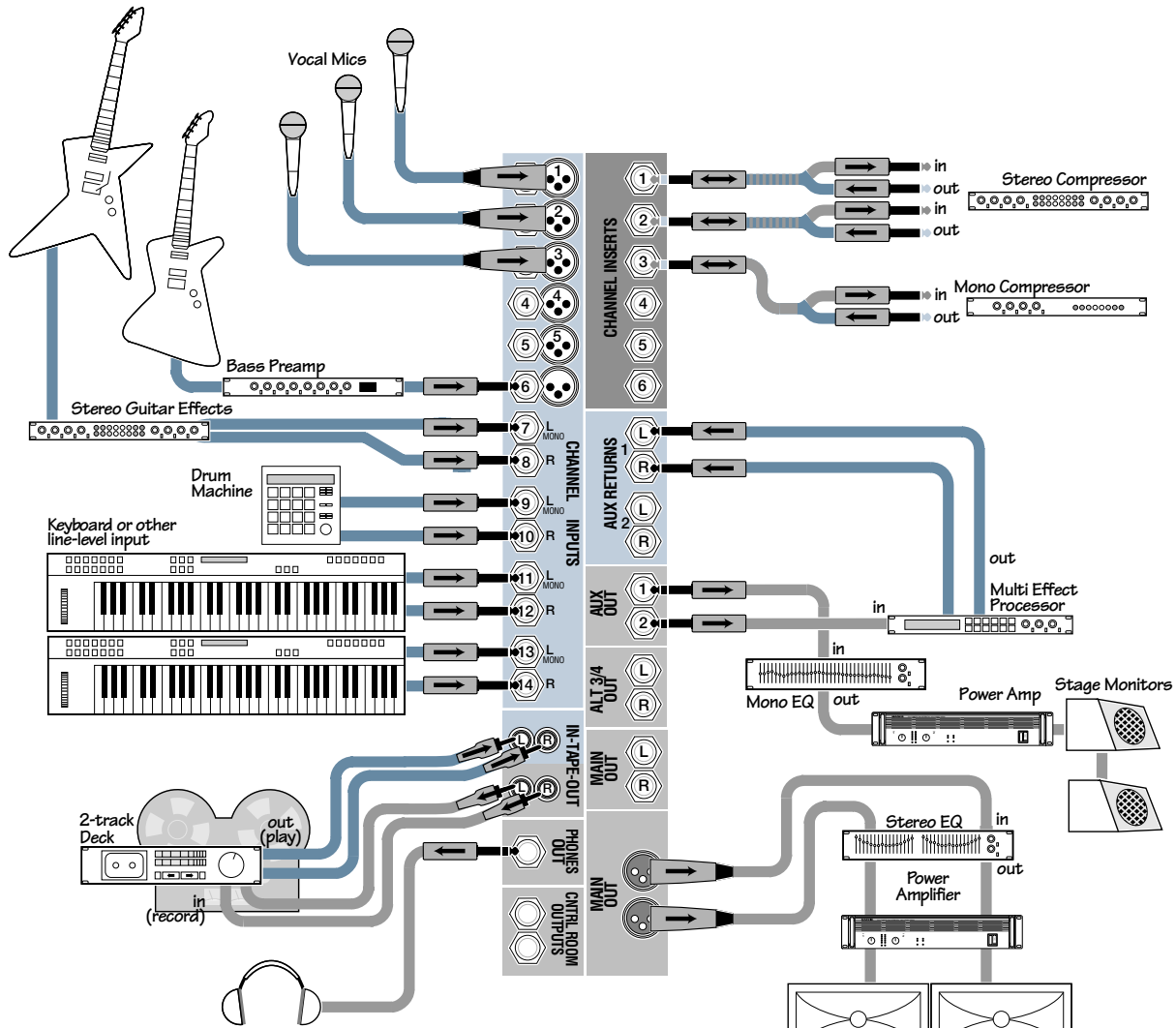

This setup can be easily reconfigured to become a Mono PA setup.

- A. Stereo sources should feed the left mono side of channel input only.
- B. Pan each channel hard left.
- C. Connect Mono PA system to Left main output.

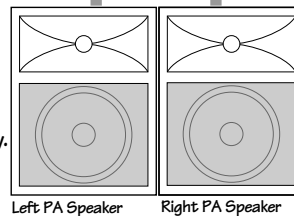

1402-VLZ PRO Stereo PA

3 1402-VLZ PRO PATCHBAY DESCRIPTION

At the risk of stating the obvious, this is where you plug everything in: microphones, line-level instruments and effects, headphones, and the ultimate destination for your sound: a tape recorder, PA system, etc.

4 MIC INPUTS (Channels 1-6)

We use phantom-powered, balanced microphone inputs just like the big studio mega-consoles, for exactly the same reason: This kind of circuit is excellent at rejecting hum and noise. You can plug in almost any kind of mic that has a standard XLR-type male mic connector. *To learn how signals are routed from these inputs:* 26. If you wire your own, connect them like this:

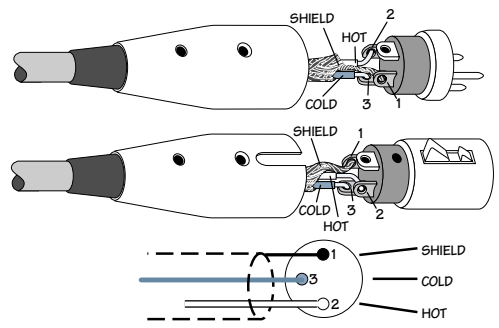

- Pin 1 = Ground or shield
- Pin 2 = Positive (+ or hot)
- Pin 3 = Negative (- or cold)

Professional ribbon, dynamic and condenser mics will all sound excellent through these inputs. The 1402-VLZ PRO's mic inputs will handle any kind of mic level you can toss at them, without overloading. Be sure to perform the **Level Setting Procedure:** 1.

5 PHANTOM POWER

Most modern professional condenser mics are equipped for Phantom Power, which lets the mixer send low-current DC voltage to the mic's electronics through the same wires that carry audio. (Semi-pro condenser mics often have batteries to accomplish the same thing.) "Phantom" owes its name to an ability to be "unseen" by dynamic mics (Shure SM57/SM58, for instance), which don't need external power and aren't affected by it anyway.

The 1402-VLZ PRO's phantom power is globally controlled by the PHANTOM switch on the rear panel 25.



Never plug single-ended (unbalanced) microphones or instruments into the MIC IN jacks if the PHANTOM power is on.

Do not plug instrument outputs into the MIC IN jacks with PHANTOM power on unless you know for certain it is safe to do so.

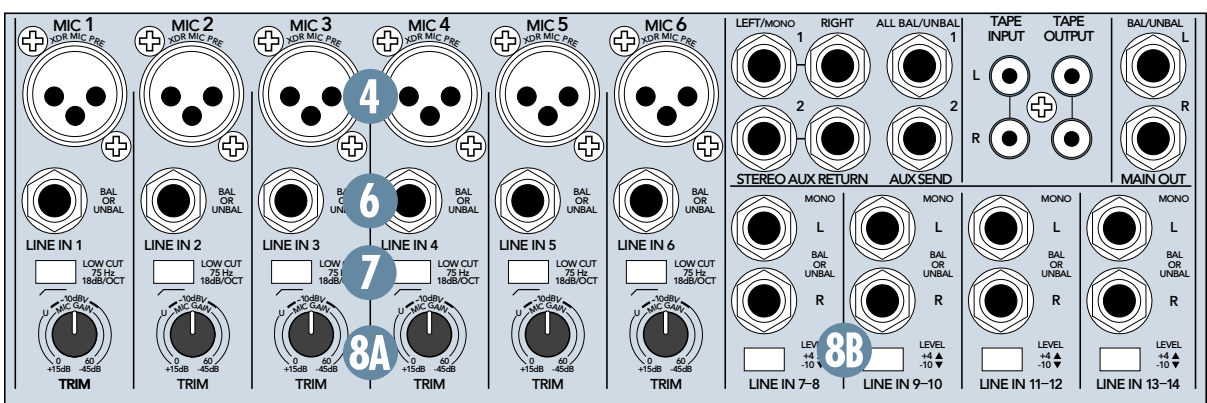

6 LINE INPUTS (Channels 1–6)

These six line inputs share circuitry (but not phantom power) with the mic preamps, and can be driven by balanced or unbalanced sources at almost any level. You can use these inputs for virtually any signal you'll come across, from instrument levels as low as -40dB to operating levels of -10dBV to $+4\text{dBu}$, since there is 40dB more gain available than on Channels 7–14. *To learn how signals are routed from these inputs:* 26.

To connect balanced lines to these inputs, use a $\frac{1}{4}$ " Tip-Ring-Sleeve (TRS) plug, the type found on stereo headphones:

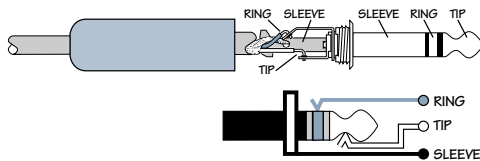

Tip = Positive (+ or hot)
Ring = Negative (– or cold)
Sleeve = Shield or ground

To connect unbalanced lines to these inputs, use a $\frac{1}{4}$ " mono (TS) phone plug or standard instrument cable:

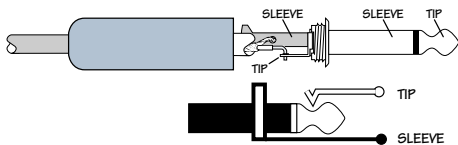

Tip = Signal
Sleeve = Ground

Line inputs 1–6 are a good place to connect older instruments that need more gain. You can correct weak levels by adjusting the corresponding channel's TRIM control 8A.

7 LOW CUT (Channels 1–6)

The LOW CUT switch, often referred to as a High Pass Filter (all depends on how you look at it), cuts bass frequencies below 75Hz at a rate of 18dB per octave.

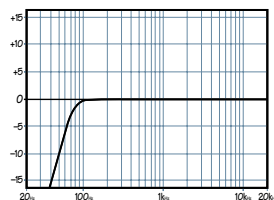

Low Cut

We recommend that you use LOW CUT on every microphone application except kick drum, bass guitar, bassy synth patches, or recordings of

earthquakes. These aside, there isn't much down there that you want to hear, and filtering

it out makes the low stuff you *do* want much more crisp and tasty. Not only that, but LOW CUT can help reduce the possibility of feedback in live situations and it helps to conserve the amplifier power.

Another way to consider LOW CUT's function is that it actually *adds* flexibility during live performances. With the addition of LOW CUT, you can safely use LOW equalization on vocals 33. Many times, bass shelving EQ can really benefit voices. Trouble is, adding LOW EQ also boosts stage rumble, mic handling clunks and breath pops. LOW CUT removes all those problems so you can add low EQ without losing a woofer.

Here's what the combination of LOW EQ 33 and LOW CUT looks like in terms of frequency curves.

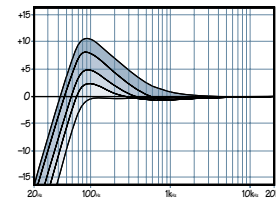

Low Cut with Low EQ

8A TRIM (Channels 1–6)

If you haven't already, please read the **Level Setting Procedure 1**.

TRIM adjusts the input sensitivity of the mic and line inputs connected to Channels 1 through 6. This allows signals from the outside world to be adjusted to optimal internal operating levels.

If the signal originates through the XLR jack, there will be 0dB of gain with the knob fully down, ramping to 60dB of gain fully up.

Through the $\frac{1}{4}$ " input, there is 15dB of attenuation fully down and 45dB of gain fully up, with a "U" (unity gain) mark at $10:00$.

This 15dB of attenuation can be very handy when you are inserting a signal that is very hot, or when you want to add a lot of EQ gain, or both. Without this "virtual pad," a scenario like that might lead to channel clipping.

8B +4 / -10 (Channels 7–14)

This switch adjusts the input sensitivity of the line inputs on channels 7–14. If the sound source is a -10 device, engage this switch. If you are unsure, leave the switch up and perform the **Level Setting Procedure 1**, substituting this switch for the TRIM knob and then setting the switch to the appropriate gain setting.

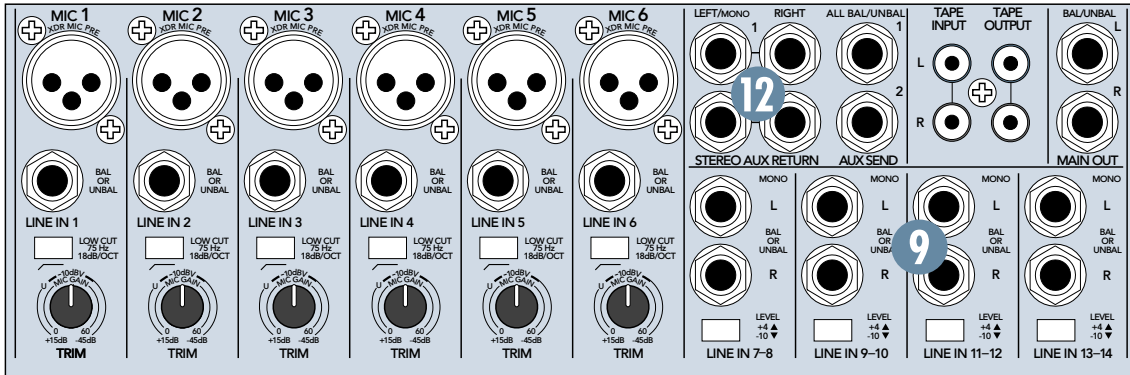

9 STEREO LINE INPUTS (Channels 7–8, 9–10, 11–12 and 13–14)

These fully balanced inputs are designed for stereo or mono, balanced or unbalanced signals, from -10dBV to $+4\text{dBu}$. They can be used with just about any professional or semi-pro instrument, effect or tape player. *To learn how signals are routed from these inputs:* 20. *To wire your own cables:* 6.

In the stereo audio world, an odd-numbered channel usually receives the “left signal.” For example, you would feed the 1402-VLZ PRO’s line inputs 7–8 a stereo signal by inserting the device’s left output plug into the Channel 7 jack, and its right output plug into the Channel 8 jack.

When connecting a mono device (just one cord), always use the Left (MONO) input and plug nothing into the Right input — this way the signal will appear on both sides. This trick is called “jack normalling” 49.



10 EFFECTS: SERIAL OR PARALLEL?

The next two sections toss the terms “serial” and “parallel” around like hacky sacks.

Here’s what we mean by them.

“Serial” means that the *entire* signal is routed through the effects device. Examples: compressor/limiters, graphic equalizers. Line-level sources can be patched through a serial effects device before or after the mixer or, more conveniently, through the channel insert jacks located on the rear of the mixer (INSERT SEND/RETURN) 11.

“Parallel” means that a *portion* of the signal in the mixer is tapped off to the device (AUX SEND), processed and returned to the mixer (AUX RETURN) to be mixed with the original “dry” signal. This way, multiple channels can all make use of the same effects device. Examples: reverb, digital delay. (See diagrams below.)

10

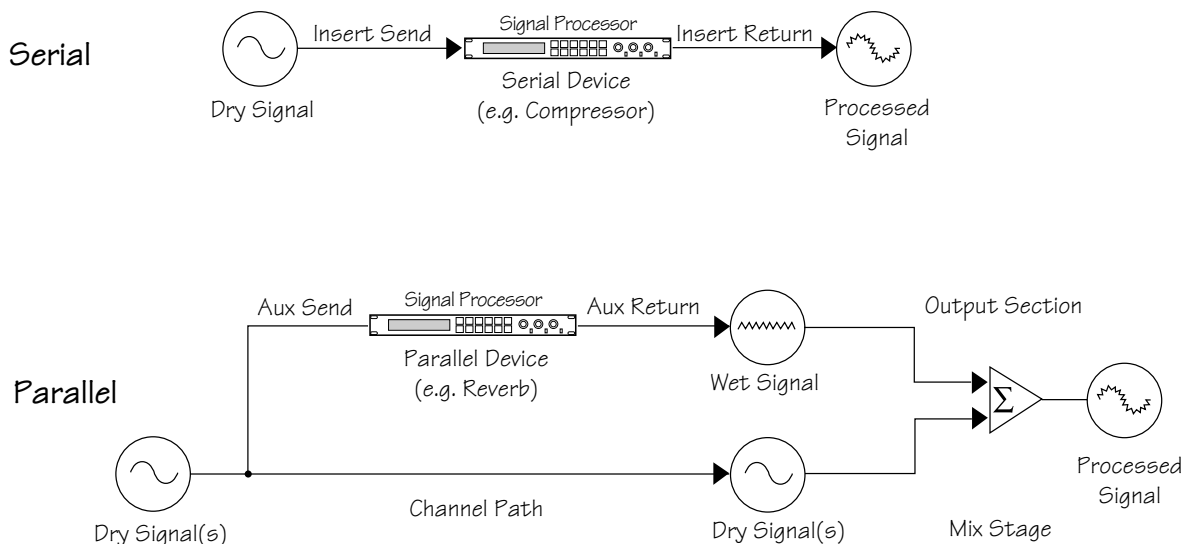

11 INSERT (Channels 1–6)

These jacks, on the back of the 1402-VLZ PRO, are where you connect serial effects such as compressors, equalizers, de-essers, or filters 10. Since most people don't have more than a few of these gadgets, we've included inserts for just the first six channels. If you want to use this kind of processing on Channels 7–14, simply patch through the processor before you plug into the 1402-VLZ PRO.

The INSERT points are after the TRIM and LOW CUT controls, but before the channel's EQ and FADER controls. The *send* (tip) is low-impedance (120 ohms), capable of driving any device. The *return* (ring) is high-impedance (over 2.5k ohms) and can be driven by almost any device.

INSERT cables must be wired thusly:

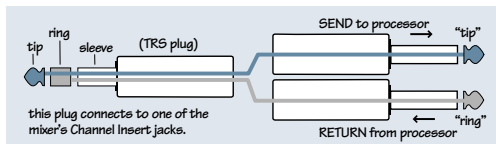

Tip = Send (output to effects device)

Ring = Return (input from effects device)

Sleeve = Common ground (connect shield to all three sleeves)

Besides being used for inserting external devices, these jacks can also be used as channel *direct outputs*; post-TRIM, post-LOW CUT, and pre EQ. Check out the 4-track hookup diagram 2. Here's three ways you can use the INSERT jacks:

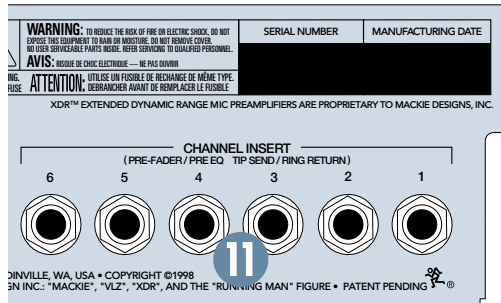
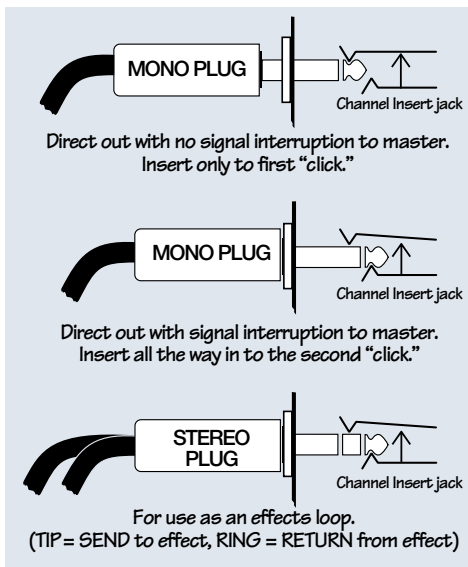

12 AUX RETURNS

This is where you connect the outputs of your parallel effects devices (or extra audio sources). These balanced inputs are similar to the stereo line inputs 9 without EQ, Aux Sends, Pan, Mute, and Solo. The circuits will handle stereo or mono, balanced or unbalanced signals, either instrument level, -10dBV or $+4\text{dBu}$. They can be used with just about any pro or semi-pro effects device on the market. *To learn how signals are routed from these inputs, see 47.*



One Device: *If you have just one parallel effects device, use AUX RETURN 1 and leave AUX RETURN 2 unplugged.*

That way, the unused AUX RETURN 2 LEVEL control can be used to feed AUX RETURN 1 to your stage monitors, via the EFX TO MONITOR switch 48.

Mono Device: *If you have an effects device with a mono output (1 cord), plug that into AUX RETURN 1 LEFT and leave AUX RETURN 1 RIGHT unplugged. That way the signal will be sent to both sides, magically appearing in the center as a mono signal. This won't work with AUX RETURN 2 — you'll need a Y-cord to feed the L/R bus. In short, AUX RETURN 1 uses jack normalling. AUX RETURN 2 does not use jack normalling.*

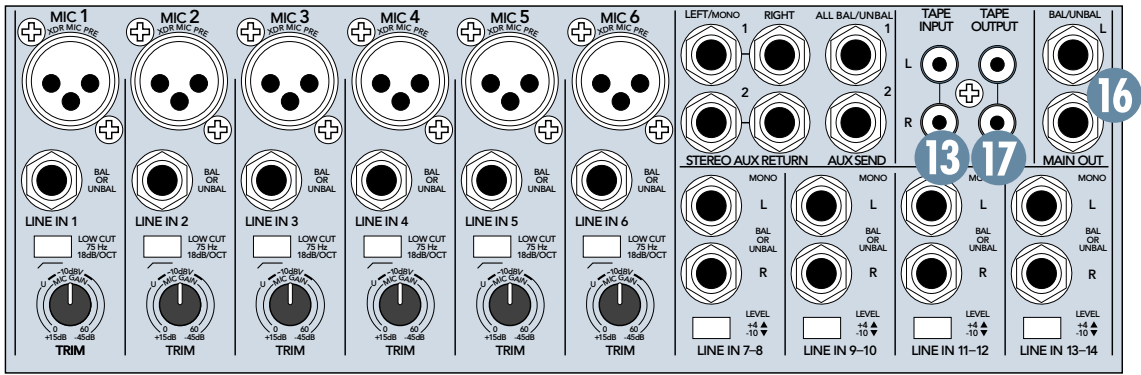

13 TAPE IN

These RCA jacks are designed to work with semi-pro as well as pro recorders. To compensate for typically low levels, signals coming in here will be automatically boosted by 6dB.

Connect your tape recorder's outputs here, using standard hi-fi (RCA) cables. *To learn how signals are routed from these inputs, see 33.*

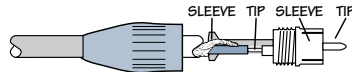

Use these jacks for convenient tape playback of your mixes. You'll be able to review a mix, and then rewind and try another pass, without repatching or disturbing the mixer levels. You can also use these jacks with a portable tape or CD player to feed music to a PA system between sets.



WARNING: Pushing TAPE in the SOURCE matrix and ASSIGN TO MAIN MIX can create a feedback path between TAPE IN and TAPE OUT. Make sure your tape deck is not in record, record-pause or input monitor mode when you engage these switches, or make sure the CTL ROOM / SUBMIX fader is fully down (off).

Outputs? The 1402-VLZ PRO has plenty of 'em: XLR MAIN, 1/4" MAIN, TAPE, PHONES, CONTROL ROOM and AUX SENDS. Let's take a peek.

14 XLR MAIN OUTPUTS

These low-impedance outputs are fully balanced and capable of driving +4dBu lines with up to 28dB of headroom. This output is 6dB hotter than other outputs. *To learn how signals are routed to these outputs: 36.*

To use these outputs, wire the XLR (balanced only) connectors like this:

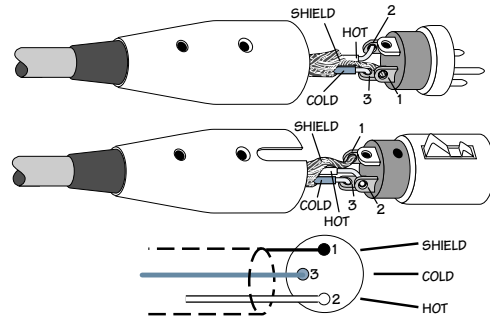

- Pin 1 = Ground
- Pin 2 = Positive (+ or hot)
- Pin 3 = Negative (- or cold)

15 MAIN OUTPUT LEVEL

Engaging this switch pads the balanced XLR MAIN OUTPUTS by 30dB, so you can feed the microphone input of, say, another mixer. Perfect for sending a submix to another mic level input in boardroom or conference room applications.

You can safely plug this output into an input that provides 48V phantom power.

16 1/4" MAIN OUTPUTS

These 1/4" jacks are balanced outputs capable of delivering 22dBu into a 600 ohm balanced or unbalanced load. (Okay, we admit it, that was a pretty technical sentence. See the **Glossary** and **Connections** appendices if you want to decode it.)

To learn how signals are routed to these 1/4" outputs: 36.

To use these outputs to drive balanced inputs, connect 1/4" TRS (Tip-Ring-Sleeve) phone plugs like this:

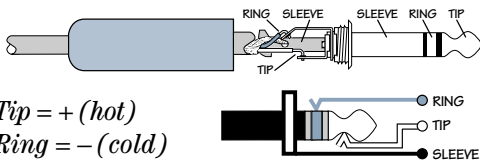

Tip = + (hot)
Ring = - (cold)
Sleeve = Ground

For most music recording and PA applications, unbalanced lines are perfectly acceptable. To use these outputs to drive unbalanced inputs, connect 1/4" TS (Tip-Sleeve) phone plugs like this:

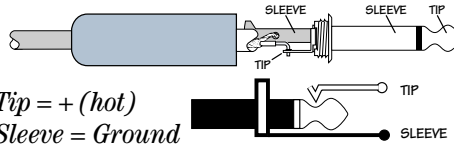

Tip = + (hot)
Sleeve = Ground

17 TAPE OUTPUT

These unbalanced RCA connections tap the MAIN OUTPUTS to make simultaneous recording and PA work more convenient. Connect these to your recorder's inputs. To learn how signals are routed to these outputs: 36.

MONO OUT: If you want to feed a mono signal to your tape deck or other device, simply use an RCA Y-cord to combine these outputs (Radio Shack® #274-511, for instance). Do not attempt this with any other outputs on the 1402-VLZ PRO.

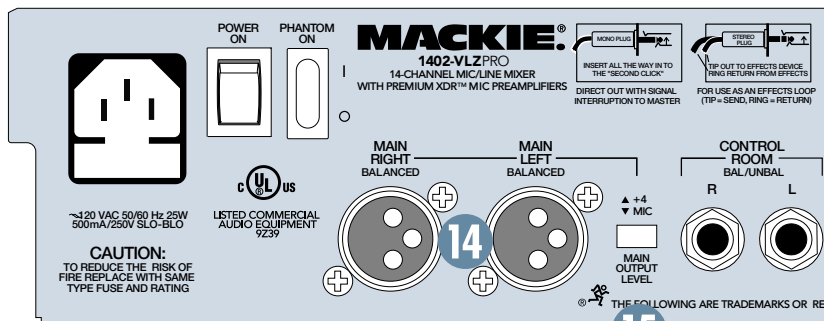
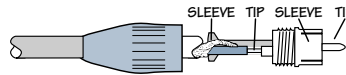

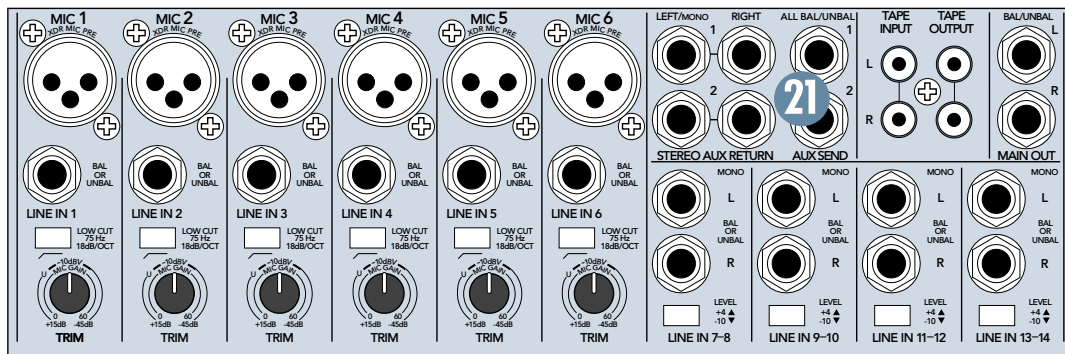

18 PHONES

The 1402-VLZ PRO's stereo PHONES jack will drive any standard headphone to very loud levels. Walkperson-type phones can also be used with an appropriate adapter. *To learn how signals are routed to these outputs:* 33. If you're wiring your own cable for the PHONES output, follow standard conventions:

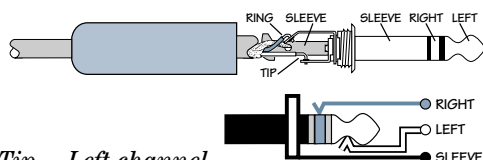

Tip = Left channel

Ring = Right channel

Sleeve = Common ground



WARNING: When we say the headphone amp is loud, we're not kidding. It can cause permanent ear damage. Even intermediate levels may be painfully loud with some earphones. BE CAREFUL!

Always turn the CTL ROOM/SUBMIX fader all the way down before connecting headphones. Keep it down until you've put the phones on. Then turn it up slowly. Why? "Engineers who fry their ears find themselves with short careers."

19 ALT 3-4 OUTPUT

These 1/4" jacks are balanced outputs capable of delivering 22dBu into a balanced or unbalanced load. *To learn how signals are routed to these outputs:* 30. *To wire your own cables:* 16.

20 CONTROL ROOM

These 1/4" jacks are balanced outputs capable of delivering 22dBu into a 600 ohm balanced or unbalanced load. *To learn how signals are routed to these outputs:* 33. *To wire your own cables:* 16.

21 AUX SEND 1&2

These 1/4" jacks are also balanced outputs capable of delivering 22dBu into a 600 ohm balanced or unbalanced load. *To learn how signals are routed to these outputs:* 34. *To wire your own cables:* 16.

22 POWER CONNECTION

Just in case you lose the cord provided with the 1402-VLZ PRO, its power jack accepts a standard 3-prong IEC cord like those found on most professional recorders, musical instruments, and computers.

At the other end of our cord is — get this — a plug! Not a black cube or, as we're fond of calling them, a “wall wart.” We did this for some very good reasons:

The 1402-VLZ PRO has sophisticated power requirements that a wall wart cannot provide. Wall warts are inconvenient, fragile, radiate huge hum fields, hog extra jacks on your power strip and get in the way. If you lose a wall wart, you're in trouble, but if you lose the 1402-VLZ PRO's power cord, you can get a new one at any electronics, music, or computer store. You can even buy them at Radio Shack® (part # 287-1257). Can you tell that we hate wall warts?

Plug the 1402-VLZ PRO into any standard grounded AC outlet or into a power strip of proper voltage.



WARNING: Disconnecting the plug's ground pin can be dangerous. Please don't do it.

23 FUSE

The 1402-VLZ PRO is fused for your (and its own) protection. If you suspect a blown fuse, disconnect the cord, pull the fuse drawer out (located just below the cord receptacle) and replace the fuse with a 500mA (0.5 amps) SLO BLO, 5x20mm, available at electronics stores or your dealer (or a 250mA SLO BLO 5x20mm if your 1402-VLZ PRO is a 220V–240V unit).

If two fuses blow in a row, something is very wrong. Please call our toll-free number (or the distributor in your country) and find out what to do.

24 POWER SWITCH

If this one isn't self-explanatory, we give up. You can leave this switch on all the time; the 1402-VLZ PRO is conservatively designed, so heat buildup isn't a problem even in 24-hour-a-day operation. There's nothing that will burn out or get used up. Or, just plug everything into a good quality power strip for one-button turn-on.



You may notice that the 1402-VLZ PRO feels quite warm in the upper-right corner. This is perfectly normal.

(Perfectly normal. Is that redundant?)

In the output section there is a POWER LED. If the power is on, so is the LED.

25 PHANTOM SWITCH

The Phantom Power Switch controls the phantom power supply for condenser microphones plugged into channels 1-6 mic inputs as discussed at the start of this section 5. When turned on (or off), the phantom power circuitry takes a few moments for voltage to ramp up (or down). This is also perfectly normal.

In the output section, next to the POWER LED, is the PHANTOM LED. If the phantom power is on, so is the LED.

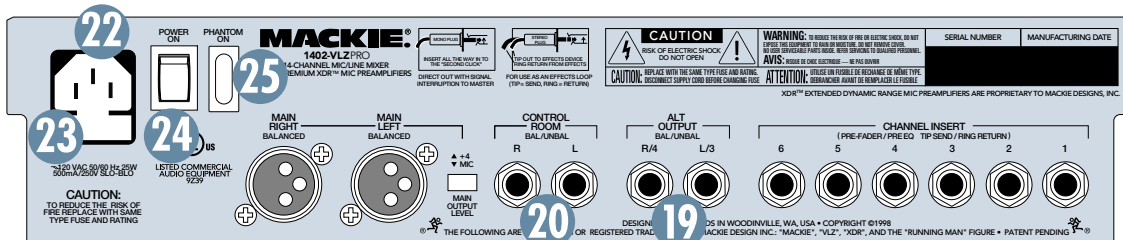

26 CHANNEL STRIP DESCRIPTION

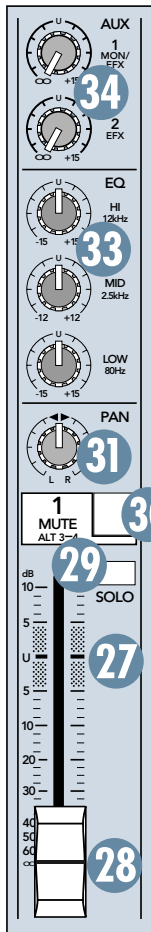

The ten channel strips look alike, and function identically. The only difference is that the six on the left are for individual mics or mono instruments and have more gain available, while the next four are for either stereo or mono line-level sources. (Each of the stereo channel strips is actually two complete circuits. The controls are linked together to preserve stereo.) We'll start at the bottom and work our way up...



27 "U" LIKE UNITY GAIN

Mackie mixers have a "U" symbol on almost every level control. This "U" stands for "unity gain," meaning no change in signal level. Once you have adjusted the input signal to line-level 1, you can set every control at "U" and your signals will travel through the mixer at optimal levels. What's more, all the labels on our level controls are measured in decibels (dB), so you'll know what you're doing level-wise if you choose to change a control's settings.

You won't have to check it here and check it there, as you would with some other mixers. In fact, some don't even have any reference to actual dB levels at all! Ever seen those "0–10" fader markings? We call these AUMs (Arbitrary Units of Measurement), and they mean nothing in the real world. You were smart — you bought a Mackie.

28 FADER

The FADER controls the channel's level... from off to unity gain at the "U" marking, on up to 10dB of additional gain. Channels 1–6 use mono controls, and channels 7–14 use stereo controls.

29 SOLO

This lovable switch allows you to hear signals through your headphones or control room 40 without having to route them to the MAIN or ALT 3–4 mixes. Folks use solo in live work to preview channels before they are let into the mix, or to just check out what a particular channel is up to anytime during a session. You can solo as many channels at a time as you like.

Solo is also the key player in the **Level Setting Procedure 1**.

Your 1402-VLZ PRO has "Dual-Mode Solo." A switch in the master section 40 determines

which mode you'll be hearing. With the switch up, you'll get "AFL" (After Fader Listen), which is post-FADER and post-PAN, making it ideal for mixdown soloing. With the switch down, you're in "PFL" (pre-fader listen) mode. This is the required mode for the **Level Setting Procedure 1**.

Soloed channels are sent to the SOURCE mix 38, which ultimately feeds your CONTROL ROOM, PHONES and METERS. Whenever SOLO is engaged, all SOURCE selections (MAIN MIX, ALT 3–4 and TAPE) are defeated, to allow the soloed signal to do just that — solo!

30 MUTE/ALT 3–4

The dual-purpose MUTE/ALT 3–4 switch is a Mackie signature. When Greg was designing our first product, he had to include a mute switch for each channel. Mute switches do just what they sound like they do. They turn off the signal by "routing" it into oblivion. "*Gee, what a waste,*" Greg reasoned. "*Why not have the mute button route the signal somewhere else useful... like a separate stereo bus?*" So MUTE/ALT 3–4 really serves two functions — muting (often used during a mixdown or live show), and signal routing (for multi-track and live work) where it acts as an extra stereo bus.

To use this as a MUTE switch, all you have to do is *not* use the ALT 3–4 outputs. Then, whenever you assign a channel to these unused outputs, you'll also be disconnecting it from the MAIN MIX, effectively muting the channel.

To use this as an ALT 3–4 switch, all you have to do is connect the ALT 3–4 outputs to whatever destination you desire. Two popular examples:

When doing multitrack recording, use the ALT 3–4 outputs to feed your multitrack. With most decks, you can mult the ALT 3–4 outputs, using Y-cords or mults, to feed multiple tracks. So, take ALT OUT LEFT and send it to tracks 1, 3, 5 and 7, and ALT OUT RIGHT and send it to tracks 2, 4, 6 and 8. Now, tracks that are in Record or Input modes will hear the ALT 3–4 signals, and tracks in Playback or Safe modes will ignore them.

When doing live sound or mixdown, it's often handy to control the level of several channels with one knob. That's called Subgrouping. Simply assign these channels to the ALT 3–4 mix, engage ALT 3–4 in the SOURCE matrix, and the signals will appear at the CONTROL ROOM

and PHONES outputs. If you want the ALT 3-4 signals to go back into the MAIN MIX, engage the ASSIGN TO MAIN MIX switch ④, and the CTL ROOM/SUBMIX fader becomes the one fader to control the levels of all channels assigned to ALT 3-4.

Another way to do the same thing is to assign the channels to the ALT 3-4 mix, then patch out of the ALT OUT LEFT and RIGHT back into an unused stereo channel (7-8, 9-10 or 11-12 or 13-14). If that's your choice, don't ever engage the MUTE/ALT 3-4 switch on that stereo channel, or you'll have every dog in the neighborhood howling at your feedback loop.

Another benefit of the ALT 3-4 feature is that it can act as a "AFL" (After Fader Listen): just engage a channel's MUTE/ALT 3-4 switch and the ALT 3-4 switch in the SOURCE matrix ③ and you'll get that channel, all by itself, in the CONTROL ROOM and PHONES.

MUTE/ALT 3-4 is one of those controls that can bewilder newcomers, so take your time and play around with it. Once you've got it down, you'll probably think of a hundred uses for it!

31 PAN

PAN adjusts the amount of channel signal sent to the left versus the right outputs. On mono channels (ch. 1-6 or 7-14 with connections to the LEFT input only) these controls act as pan pots. On stereo channels (7-14) with stereo connections to LEFT and RIGHT inputs, the pan knob works like the balance control on your home stereo.

PAN determines the fate of the MAIN MIX (1-2) and ALT 3-4 mix. With the PAN knob hard left, the signal will feed either MAIN LEFT (bus 1) or ALT LEFT (bus 3), depending on the position of the ALT 3-4 switch. With the knob hard right, the signal feeds MAIN RIGHT (bus 2) or ALT RIGHT (bus 4). You'll soon discover that maybe we should've called this an 1404-VLZ², since it really is a 4-bus mixer.



32 CONSTANT LOUDNESS !!!

The 1402-VLZ PRO's PAN controls employ a design called "Constant Loudness."

It has nothing to do with living next to a freeway. As you turn the PAN knob from left to right (thereby causing the sound to move from the left to the center to the right), the sound will appear to remain at the same volume (or loudness).

If you have a channel panned hard left (or right) and reading 0dB, it must dip down about 4dB on the left (or right) when panned

center. To do otherwise (the way Brand X compact mixers do) would make the sound appear much louder when panned center.



33 3-BAND EQ

The 1402-VLZ PRO has 3-band equalization at carefully selected points — LOW shelving at 80Hz, MID peaking at 2.5kHz, and HI shelving at 12kHz. "Shelving" means that the circuitry boosts or cuts all frequencies past the specified frequency. For example, rotating the 1402-VLZ PRO's LOW EQ knob 15dB to the right boosts bass starting at 80Hz and continuing down to the lowest note you never heard. "Peaking" means that certain frequencies form a "hill" around the center frequency — 2.5kHz in the case of the MID EQ.

LOW EQ

This control gives you up to 15dB boost or cut at 80Hz. The circuit is flat (no boost or cut) at the center detent position. This frequency represents the punch in bass drums, bass guitar, fat synth patches, and some really serious male singers.

Used in conjunction with the LOW CUT switch ⑦, you can boost the LOW EQ without injecting a ton of subsonic debris into the mix.

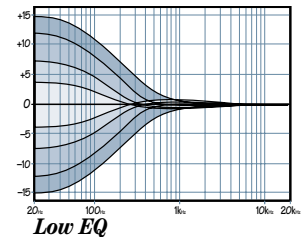

MID EQ

Short for "midrange," this knob provides 12dB of boost or cut, centered at 2.5kHz, also flat at the center detent. Midrange EQ is often thought of as the most dynamic, because the frequencies that define any particular sound are almost always found in this range. You can create many interesting and useful EQ changes by turning this knob down as well as up.

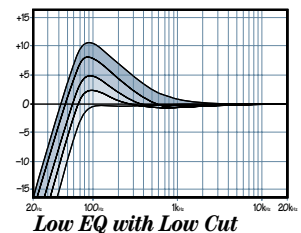

HI EQ

This control gives you up to 15dB boost or cut at 12kHz, and it is also flat at the detent. Use it to add sizzle to cymbals, and an overall sense of transparency or edge to keyboards, vocals, guitar and bacon frying. Turn it down a little to reduce sibilance, or to hide tape hiss.

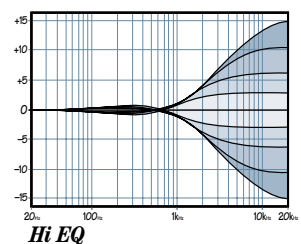
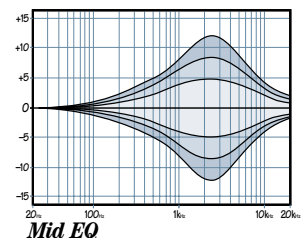

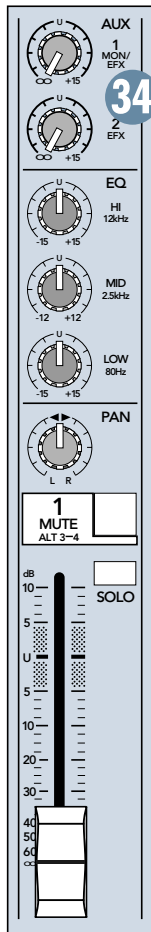

Moderation during EQ

With EQ, you can also screw things up royally. We've designed a lot of boost and cut into each equalizer circuit, because we know everyone will occasionally need that. But if you max the EQs on every channel, you'll get mix mush. Equalize subtly and use the left sides of the knobs (cut), as well as the right (boost). Very few gold-record-album engineers ever use more than about 3dB of EQ. If you need more than that, there's usually a better way to get it, such as placing a mic differently (or using a different kind of mic entirely).

34 AUX SEND

These tap a portion of each channel signal out to another source for parallel effects processing or stage monitoring. AUX send levels are controlled by the channel's AUX 1 and AUX 2 knobs 34 and by the AUX 1 MASTER 46.

These are more than just effects and monitor sends. They can be used to generate separate mixes for recording or "mix-minuses" for broadcast. By using AUX 1 in the PRE mode 45, these mix levels can be obtained independently of the channel's GAIN control.

AUX 1 in POST-mode 45 and AUX 2 are post-LOW CUT, post-EQ and post-FADER. That is, the sends obey the settings of these controls. AUX 1 in PRE mode follows the EQ and LOW CUT settings only. PAN and FADER have no effect on the PRE send (see diagram below).

All AUX send levels range from *off* through *unity* (with their channel gain controls at the center detent position) on up to 15dB of extra gain (when turned fully clockwise). Chances are you'll never need this extra gain, but it's nice to know it's there if you do.

Channel 7–14 AUX pots control the mono sum of the channel's stereo signals for each AUX send. For instance, Channel 7 (left) and 8 (right) mix together to feed that channel's AUX send knobs.

We recommend going into a stereo reverb in mono and returning in stereo. We have found that most "stereo" reverbs' second input just ties up an extra AUX send and adds nothing to the sound. There are exceptions, so feel free to try it both ways. If your effects device is true stereo all the way through, use AUX 1 to feed its LEFT input and AUX 2 to feed the RIGHT input.

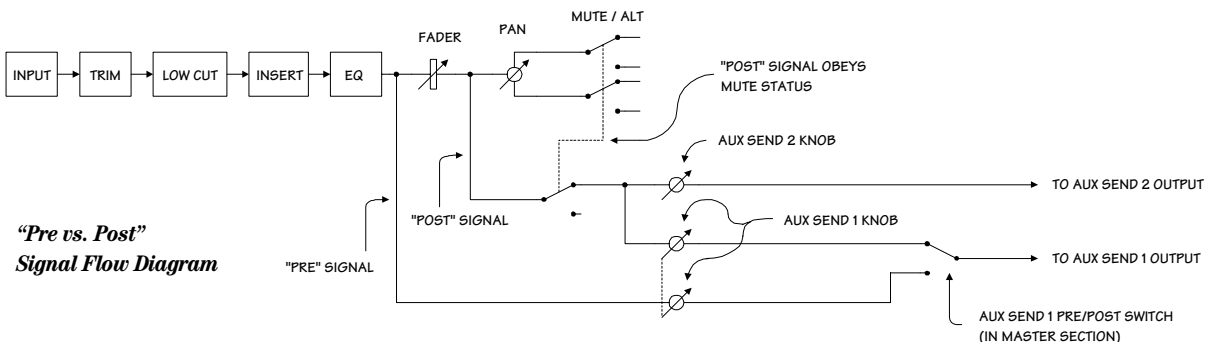

35 OUTPUT SECTION DESCRIPTION

Still with us? Good for you. Here come the tricky parts, where the mixing is really done.

36 MAIN MIX

As the name implies, this fader controls the levels of signals sent to the MAIN OUTPUTS: XLR 14, 1/4" 16 and RCA TAPE OUT 17. All channels and AUX RETURNS that are not muted or turned fully down will wind up in the MAIN MIX.

Fully down is off, the "U" marking is unity gain, and fully up provides 10dB additional gain. This additional gain will typically never be needed, but once again, it's nice to know it's there. These are the faders to pull down at the end of the song when you want The Great Fade-Out.



37 VLZ MIX ARCHITECTURE

When designing a mixing circuit, the lowest noise and best crosstalk specs are achieved by using Very Low Impedance (VLZ). To implement VLZ in a mixer, the power supply must be able to deliver plenty of current to the circuitry. That's why those "wall wart" mixers are often noisy – they can't power a VLZ circuit.

At Mackie, audio quality is much more important than the price of wall warts. All of our mixers employ VLZ and built-in power supplies that deliver more than enough current, resulting in sonic specifications that rival consoles upwards of \$50,000!

38 SOURCE MATRIX

Typically, the engineer sends the MAIN MIX to an audience (if live) or a mixdown deck (if recording). But what if the engineer needs to hear something other than the MAIN MIX? With the 1402-VLZ PRO, the engineer has several choices of what to listen to. This is one of those tricky parts, so buckle up.

Via the SOURCE switches, you can choose to listen to any combination of MAIN MIX, ALT 3-4 and TAPE. By now, you probably know what the MAIN MIX is. ALT 3-4 is that additional stereo mix bus. TAPE is the stereo signal coming in from the TAPE IN RCA jacks 13.

Selections made in the SOURCE matrix deliver stereo signals to the CONTROL ROOM, PHONES and METERS. With no switches engaged, there will be no signal at these outputs and no meter indication.

The exception to that is the SOLO function 29. Regardless of the SOURCE matrix selection, engaging a channel's SOLO switch will replace that selection with the SOLO signal, also sent to the CONTROL ROOM, PHONES and METERS. This is what makes the **Level Setting Procedure** 1 so easy to do.



WARNING: Pushing in both the TAPE button (in the SOURCE matrix) and ASSIGN TO MAIN MIX can create a feedback path between TAPE IN and TAPE OUT. Make sure your tape deck is not in record, record-pause or input monitor mode when you engage these switches, or make sure the CONTROL ROOM / PHONES fader is fully down (off).

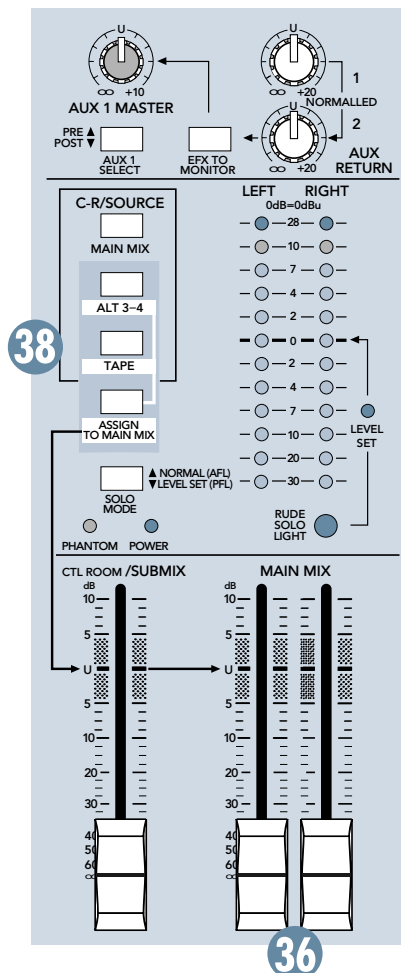

Now you know how to select the signals you want to send to the engineer's control room or phones. From there, these signals all pass through the same level control:

39 CTL ROOM / SUBMIX

This fader controls the levels of both the stereo CONTROL ROOM OUTPUTS 20 and PHONES OUTPUTS 18. The control range is from *off* through *unity* gain at the "U" marking, with 10dB of extra gain fully up.

When MAIN MIX is your SOURCE selection, those signals will pass through two level controls on the way to your control room amp and phones — the MAIN MIX fader and this CTL ROOM / SUBMIX fader. This way, you can send a nice healthy level to the MAIN OUTPUTS (MAIN MIX fader at "U"), and a quiet level to the control room or phones (CTL ROOM / SUBMIX fader wherever you like it).

When ALT 3-4 or TAPE is selected, or SOLO is engaged, this fader will be the only one controlling these levels (channel controls notwithstanding).

Whatever your selection, you can also use the CONTROL ROOM OUTPUTS for other applications. It's sound quality is just as impeccable as the MAIN MIX outputs. It can be used as additional MAIN MIX output, which may sound silly since there are already three, but this one has its own level control. However, should you do something like this, be sure that you never engage a SOLO switch, as that will interrupt your SOURCE selection.

40 SOLO MODE: AFL/PFL

Engaging a channel's SOLO switch 29 will cause this dramatic turn of events: Any existing SOURCE matrix selections will be replaced by the SOLO signal, appearing at the CONTROL ROOM OUTPUTS, PHONES OUTPUTS and at the METERS. The audible SOLO levels are then controlled by the CTL ROOM / SUBMIX fader. The SOLO levels appearing on the METERS 43 are not controlled by anything — you wouldn't want that. You want to see the actual channel level on the METERS regardless of how loud you're listening.

With the SOLO MODE switch in the up position, you're in AFL mode, meaning After-Fader Listen. You'll hear the output of the soloed channel — it will follow the channel's TRIM, EQ, FADER and PAN settings. It's similar to muting all the other channels, but without the hassle. Use AFL mode during mixdown.

With the switch down, you're in PFL mode, meaning Pre-Fader Listen (post EQ). This mode is required for the **Level Setting Procedure 1** and is handy for quick spot-checks of channels, especially ones that have their faders turned down.

In either mode, SOLO will not be affected by a channel's MUTE/ALT switch position.

41 RUDE SOLO LIGHT

This flashing Light Emitting Diode serves two purposes — to remind you that at least one channel is in SOLO, and to let you know that you're mixing on a Mackie. No other company is so concerned about your level of SOLO awareness. If you work on a mixer that has a solo function with no indicator lights, and you happen to forget you're in solo, you can easily be tricked into thinking that something is wrong with your mixer. Hence the RUDE SOLO LIGHT. It's especially handy at about 3AM when no sound is coming out of your monitors but your multitrack is playing back like mad.

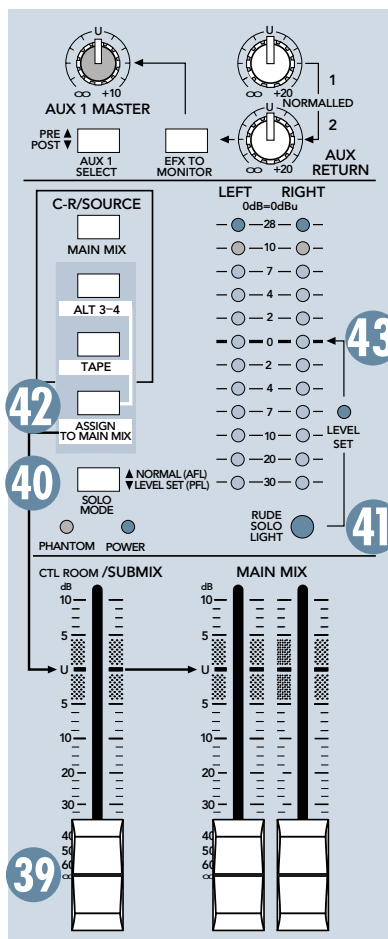

42 ASSIGN TO MAIN MIX

Let's say you're doing a live show. Intermission is nearing and you'll want to play a soothing CD for the crowd to prevent them from becoming antsy. Then you think, "*But I have the CD player plugged into the TAPE inputs, and that never gets to the MAIN OUTPUTS!*" Oh, but it does. Simply engage this switch and your SOURCE matrix selection, after going through the CTL ROOM / SUBMIX fader, will feed into the MAIN MIX, just as if it were another stereo channel.

Another handy use for this switch is to enable the ALT 3-4 mix to become a submix of the MAIN MIX 36, using the CTL ROOM / SUBMIX fader as its level control.

Side effects: (1) Engaging this switch will also feed any soloed channels into the MAIN MIX, which may be the last thing you want. (2) If you have MAIN MIX as your SOURCE matrix selection and then engage ASSIGN TO MAIN MIX, the MAIN MIX lines to the SOURCE matrix will be interrupted, to prevent feedback. Then again, why on earth would anyone want to assign the MAIN MIX to the MAIN MIX?

43 METERS – MANY DISPLAYS IN ONE!

The 1402-VLZ PRO's peak metering system is made up of two columns of twelve LEDs. Deceptively simple, considering the multitude of signals that can be monitored by it.

If nothing is selected in the SOURCE matrix 38 and no channels are in SOLO, the METERS will just sit there and look stupid. To put them to work, you must make a selection in the SOURCE matrix (or engage a SOLO switch).

Why? You want the METERS to reflect what the engineer is listening to, and as we've covered, the engineer is listening either to the CONTROL ROOM outputs or the PHONES outputs. The only difference is that while the listening levels are controlled by the CTL ROOM / SUBMIX fader, the METERS read the SOURCE mix before that control, giving you the real facts at all times, even if you're not listening at all.



You may already be an expert at the world of "+4" (+4dBu=1.23V) and "-10" (-10dBV=0.32V) operating levels. Basically, what makes a mixer one or the other is the relative 0dB VU (or 0VU) chosen for the meters. A "+4" mixer, with a +4dBu signal pouring out the back will actually read 0VU on its meters. A "-10" mixer, with a -10dBV signal trickling out, will read, you guessed it, 0VU on its meters. So when is 0VU actually 0dBu? Right now!

At the risk of creating another standard, Mackie's compact mixers address the need of both crowds by calling things as they are — 0dBu (0.775V) at the output shows as 0dB VU on the METERS. What could be easier? By the way, the most wonderful thing about standards is that there are so many to choose from.

Thanks to the 1402-VLZ PRO's wide dynamic range, you can get a good mix with peaks flashing anywhere between -20 and +10dB on the METERS. Most amplifiers clip at about +10dB, and some recorders aren't so forgiving either. For best real-world results, try to keep your peaks between "0" and "+7."

Remember, audio meters are just tools to help assure you that your levels are "in the ballpark." You don't have to stare at them (unless you want to).



44 AUX TALK

First of all, there is no particular alliance between **AUX SEND 1** (or 2) and **AUX RETURN 1** (or 2). They're just numbers. They're like two complete strangers, both named Fred.

Here's the whole idea behind sends and returns: sends are outputs, returns are inputs. **AUX SENDs** tap signals off the channels, via their **AUX knobs** 34, mix these signals, then send them out via the **AUX SEND jacks** 21.

These outputs are fed to the inputs of a reverb or other device. From there, the outputs of this external device are fed back to the mixer's **AUX RETURN jacks** 12. Then these signals are sent through the **AUX RETURN level controls**, and finally delivered to the **MAIN MIX**.

So, the original "dry" signals go from the channels to the **MAIN MIX** and the affected "wet" signals go from the **Aux Returns** to the **MAIN MIX**, and once mixed together, the dry and wet signals combine to create a glorious sound. So, armed with this knowledge, let's visit the Auxiliary World:

45 AUX 1 SELECT

Besides being used to work effects into your mix, **Aux Sends** serve another critical role — that of delivering cue mixes to stage monitors, so musicians can hear what they're doing. On the 1402-VLZ PRO, **AUX SEND 1** can play either role, depending on the position of this switch.

With the **AUX 1 SELECT** switch up (disengaged), **AUX SEND 1** will tap a channel *pre-FADER* and *pre-MUTE/ALT 3-4*, meaning that no matter how you manipulate those controls as they feed the **MAIN MIX**, the **AUX SEND** will continue to belt out a constant signal level. This is the preferred method for setting up stage monitor feeds. **EQ settings** will affect all **AUX SENDs**.

With the switch down, **AUX SEND 1** becomes an ordinary effects send — *post-FADER* and *post-MUTE/ALT 3-4*. This is a must for effects sends, since you want the levels of your "wet" signals to follow the level of the "dry."

46 AUX 1 MASTER

The **AUX 1 MASTER** provides overall level control of **AUX SEND 1**, just before it's delivered to the **AUX 1 OUTPUT**. (**AUX SEND 2** has no such control.) This knob goes from *off* (turned fully down), to *Unity gain* at the center detent, with **10dB** of extra gain (turned fully up). As with some other level controls, you may never need the additional gain, but if you ever do, you'll be glad you bought a Mackie.

This is usually the knob you turn up when the lead singer glares at you, points at his stage monitor, and sticks his thumb up in the air. (It would follow suit that if the singer stuck his thumb down, you'd turn the knob down, but that never happens.)

47 AUX RETURNS

These two controls set the overall level of effects received from **STEREO AUX RETURN** inputs 1 and 2 12. These controls are designed to handle a wide range of signal levels, from *off*, to *unity gain* at the detent, with **20dB** gain fully clockwise, to compensate for low-level effects.

Typically, these knobs can just live at the center detent, and the effects device's output control should be set at whatever they call *Unity gain* (check their manual). If that turns out to be too loud or too quiet, adjust the effects device's outputs, not the mixer. That way, the mixer's knobs are easy to relocate at the center detent.

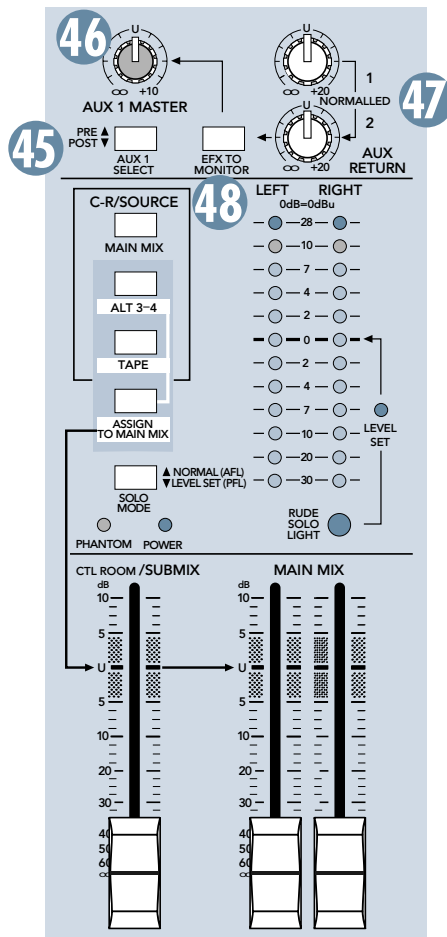

Signals passing through the AUX RETURN level controls will proceed directly to MAIN MIX 36, with one exception (see next paragraph). The AUX RETURNS do not have MUTE/ALT 3-4 switches, so if you want these signals to get to the ALT 3-4 mix, you'll have to patch the effects device's outputs into one of the stereo channels, and MUTE/ALT that channel 30.

48 EFX TO MONITOR

The idea behind this great feature is simple: If you want to add reverb or delay to the stage monitor mixes, this is the switch for you. The implementation leading up to the switch is the tricky part:

With the switch up, AUX RETURN 1 and 2 behave normally — they deliver their signals into the MAIN MIX. With the switch down, AUX RETURN 1 still behaves normally, but AUX RETURN 2's level control will feed AUX SEND 1 41 instead of the MAIN MIX.

Still with us? Good. So far, with the switch down, we have AUX RETURN 1 feeding the MAIN MIX and AUX RETURN 2 feeding AUX SEND 1. Now, suppose you only have one effects device, and you want it to feed both the MAIN MIX and AUX SEND 1. That's where "jack normalling" comes in.

49 JACK NORMALLING

Jack normalling (not to be confused with Jack Normalling, Chicago Cubs utility infielder, 1952-61, .267 LBA) is a feature found on almost every mixer, keyboard and effects device. These jacks have special spring-loaded pins that connect to the signal pins, but when something is plugged into the jack, that connection is broken.

These normalling pins can be used in all sorts of ways. The ubiquitous phrase "LEFT (MONO)" means that if you plug a signal into the LEFT side and have nothing in the RIGHT side, that signal is also fed to the right input, courtesy of jack normalling. As soon as you plug something in the RIGHT side, that normalled connection is broken.

How does all this relate to the EFX TO MONITOR switch? AUX RETURN 1's inputs are normalled to AUX RETURN 2. If you have one effects device, plug it into AUX RETURN 1. Plug nothing into AUX RETURN 2. Now the signals feeding the AUX RETURN 1 inputs will also be sent to the AUX RETURN 2 inputs.

Engage the EFX TO MONITOR switch, and now the AUX RETURN 2 knob will become an additional AUX SEND 1 knob for the signal at the AUX RETURN 1 12. Say that ten times! Once again, AUX RETURN 1 will behave normally, as always.

Congratulations! You've just read about all the features of your 1402-VLZ PRO. You're probably ready for a cold one. Go ahead. The rest of the manual can wait.

50 MODIFICATIONS

For most folks, the 1402-VLZ PRO works just fine the way it is. But for special applications, there are three signal routing changes that can be performed easily on the 1402-VLZ PRO. Easy for someone with soldering experience, that is. If you don't know how to solder, find a technician that can. This is NOT a good place to learn!

- Modification A changes AUX SEND 2 to be *pre-fader*, *pre-mute* instead of *post-fader*, *post-mute*.
- Mod B changes AUX SEND 1 (in *post* mode) and AUX SEND 2 to receive signal regardless of the channel's MUTE/ALT switch position, but still be *post-fader* (GAIN knob).
- Mod C changes the SOURCE matrix's MAIN MIX selection to tap the stereo signal before the MAIN MIX level control (*pre*) instead of after (*post*).

Instructions for performing these modifications can be found on our website at www.mackie.com (click on Support). Or you can call Tech Support at 1-800-258-6883 for assistance.

51 1402-VLZ PRO BLOCK DIAGRAM

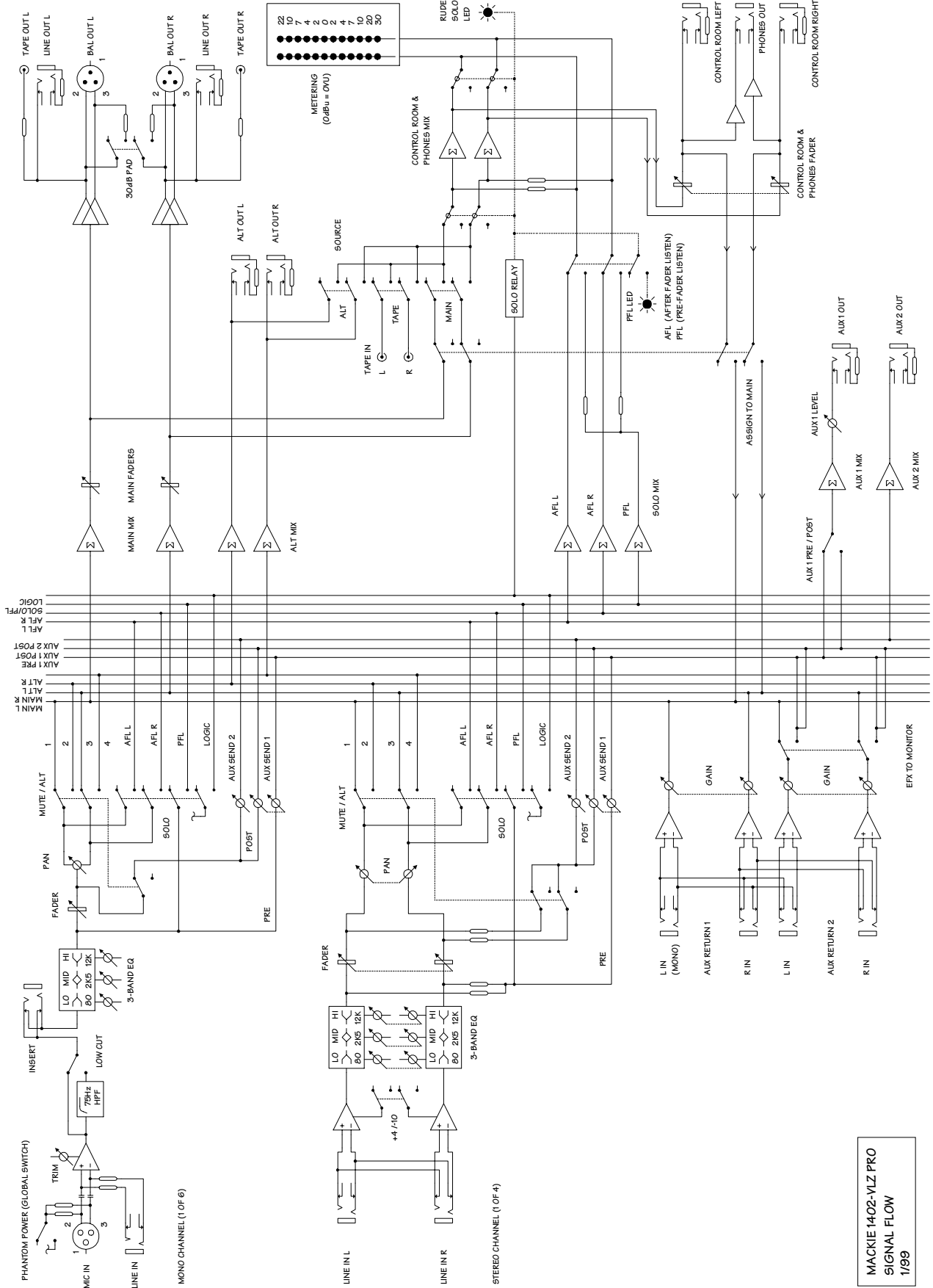

MACKIE 1402-VLZ PRO
SIGNAL FLOW
1/99

52 GAIN STRUCTURE DIAGRAM

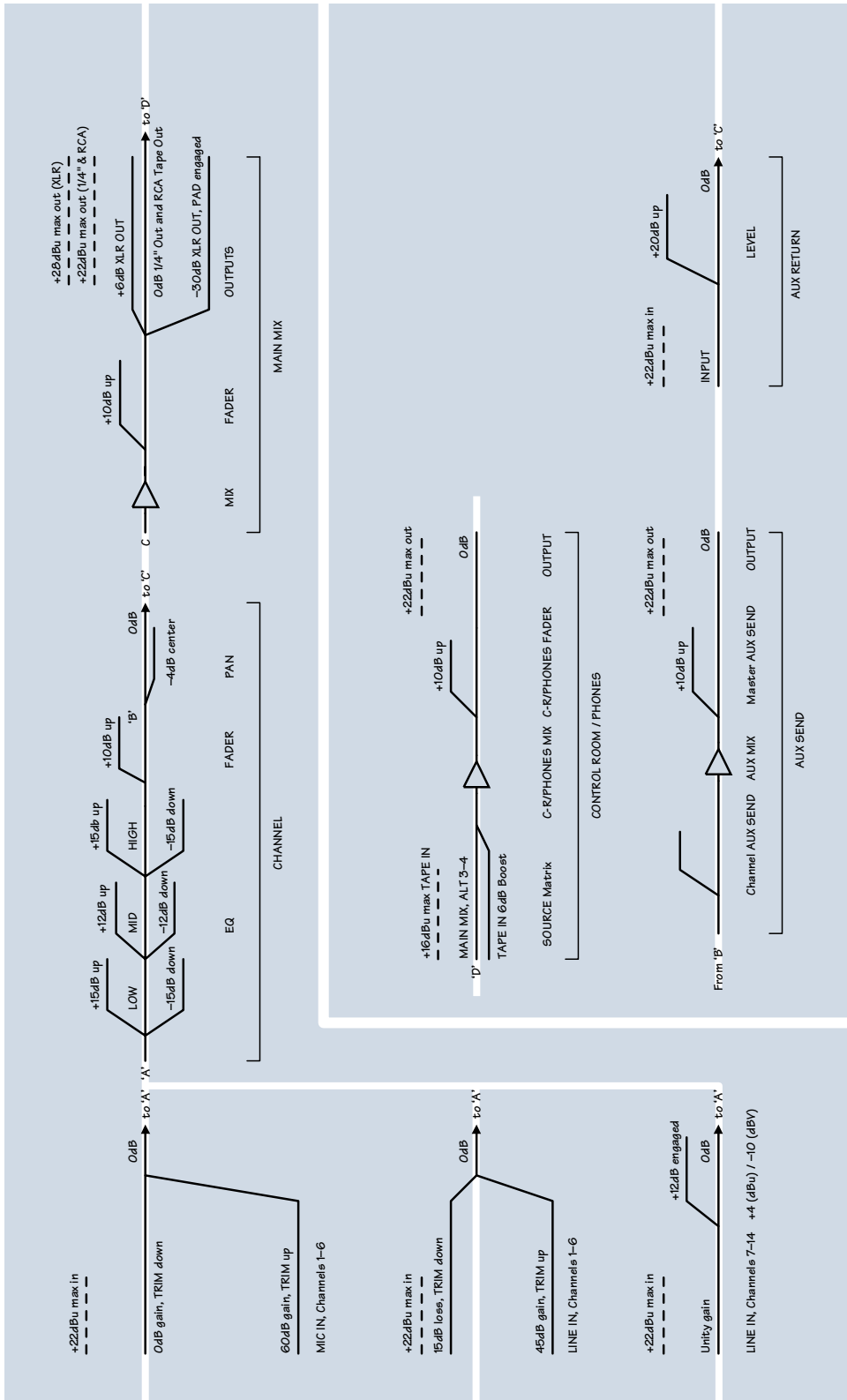

53 SPECIFICATIONS

Main Mix Noise

20Hz–20kHz bandwidth, 1/4" Main out, channels 1–6 Trim @ unity gain, channel EQs flat, all channels assigned to Main Mix, channels 1 and 3 Pan left, 2 and 4 Pan right.

Main Mix fader down, channel faders down: –100.0dBu

Main Mix fader unity, channel faders down: –86.5dBu (90dB Signal-to-Noise Ratio, ref +4dBu)

Main Mix fader @ unity, channel faders @ unity: –84.5dBu

Total Harmonic Distortion (THD)

1kHz @ +14dBu, 20Hz–20kHz

Mic pre @ insert : 0.0007%

Attenuation (Crosstalk)

1kHz relative to 0dBu, 20Hz–20kHz

bandwidth, Line in, 1/4" Main Out, Trim @ unity

Main fader down: –85dBu

Channel Alt / Mute switch engaged: –84dBu

Channel fader down: –83dBu

Frequency Response

Mic input to any output

20Hz to 60kHz: +0dB/–1dB

20Hz to 100kHz: +0dB/–3dB

Equivalent Input Noise (EIN)

Mic in to Insert Send out, max gain

150 ohm termination: –129.5dBm unweighted

Common Mode Rejection (CMR)

Mic in to Insert Send out, max gain

1kHz: better than –90dB

Maximum Levels

Mic in: +22dBu

Tape in: +16dBu

All other inputs: +22dBu

Main Mix XLR out: +28dBu

All other outputs: +22dBu

Impedances

Mic in: 1.3 kilohms

Channel Insert return: 2.5 kilohms

All other inputs: 10 kilohms or greater

Tape out: 1.1 kilohms

All other outputs: 120 ohms

EQ

High Shelving: +/-15db @ 12kHz

Mid Peaking: +/-12dB @ 2.5kHz

Low Shelving: +/-15db @ 80Hz

Power Consumption

120VAC, 50/60Hz, 25 watts

Fuse Rating

120V: 500mA slo blo, 5 x 20mm

220–240V: 250mA slo blo, 5 x 20mm

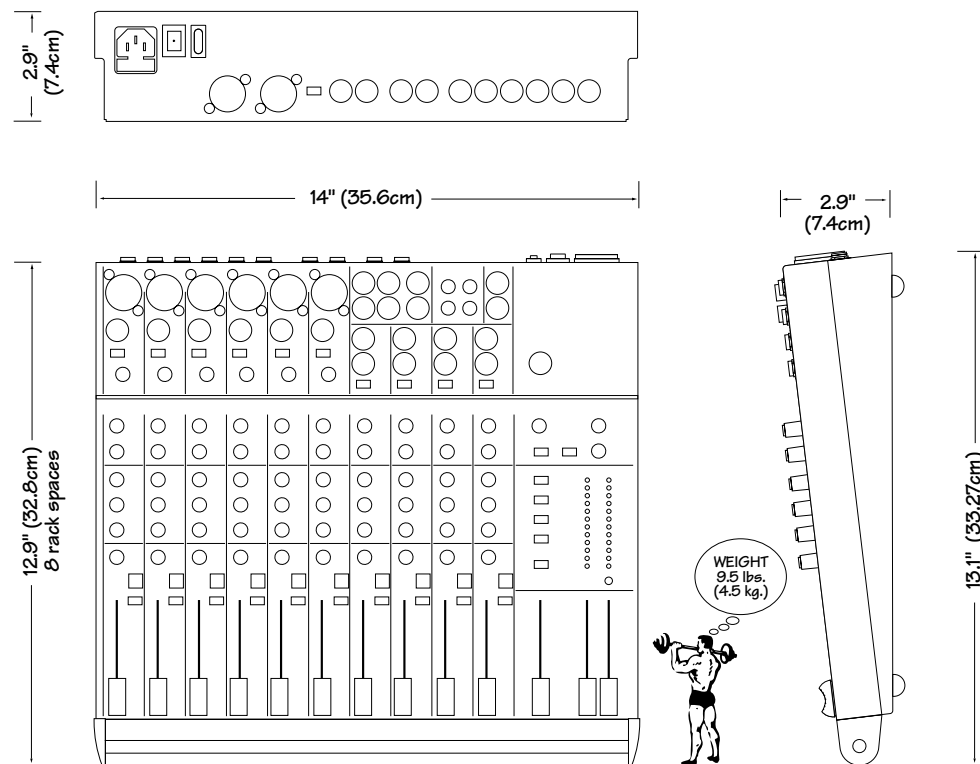

Mackie Designs is always striving to improve our mixers by incorporating new and improved materials, components and manufacturing methods. Because we're always trying to make things better, we reserve the right to change these specifications at any time, without notice.

54 SERVICE INFO

Details concerning Warranty Service are spelled out on the Warranty Card included with your mixer (if it's missing, let us know and we'll rush one to you).

If you think your 1402-VLZ PRO has a problem, please do everything you can to confirm it before calling for service. Doing so might save you from the deprivation of your mixer and the associated suffering.

Of all Mackie products returned for service (which is hardly any at all), roughly 50% are coded "CND" — Could Not Duplicate, which usually means the problem lay somewhere other than the mixer. These may sound obvious to you, but here's some things you can check:

TROUBLESHOOTING

Bad Channel

- Is the MUTE/ALT 3–4 switch in the correct position?
- Is the fader turned up?
- Try unplugging any INSERT devices (Channels 1–6 only).
- Try the same source signal in another channel, set up exactly like the suspect channel.

Bad Output

- Is the associated level control (if any) turned up?
- If it's one of the Main outputs, try unplugging all the others. For example, if it's the ¼" Left Main out, unplug the RCA and XLR Left outputs. If the problem goes away its not the mixer.
- If it's a stereo pair, try switching them around. For example, if a left output is presumed dead, switch the left and right cords, at the mixer end. If the problem stays on the left it's not the mixer.

Noise

- Turn the channel fader and AUX RETURN knobs down, one by one. If the sound disappears, it's either that channel or whatever is plugged into it, so unplug whatever that is. If the noise disappears, it's from your whatever.

Power

- Our favorite question: Is the POWER switch on?
- Check the fuse 23.

REPAIR

Service for the U.S. version of the 1402-VLZ PRO is available only from Mackie Designs, located in sunny Woodinville, Washington.

(Service for mixers living outside the United States can be obtained through local dealers or distributors.) If your mixer needs service, follow these instructions:

1. Review the preceding troubleshooting suggestions. Please.
2. Call Tech Support at 1-800-258-6883, 8am to 5pm PST, to explain the problem and request an RA number. Have your mixer's serial number ready. **You must have a Return Authorization number, or we may refuse the delivery.**
3. Set aside the power cord, owner's manual, or anything else that you'll ever want to see again. We are responsible for the return of the mixer only.
4. Pack the mixer in its original package, including endcaps and box. This is **VERY IMPORTANT**. When you call for the RA number, please let Tech Support know if you need a new box. *Mackie is not responsible for any damage that occurs due to non-factory packaging.*
5. Include a legible note stating your name, shipping address (no P.O. boxes), daytime phone number, RA number and a detailed description of the problem, including how we can duplicate it.
6. Write the RA number in **BIG PRINT** on top of the box.
7. Ship the mixer to us. We suggest insurance for all forms of cartage. Ship to this address:
**Mackie Designs
SERVICE DEPARTMENT
16220 Wood-Red Rd. NE
Woodinville, WA 98072**
8. We'll try to fix the mixer within five business days. Ask Tech Support for current turn-around times when you call for your RA number. We normally send everything back prepaid using three-day shipping. However, if you rush your mixer to us by next-day air, we'll treat it in kind by shipping it back in the same way in which it was received. This paragraph does not necessarily apply to non-warranty service.

APPENDIX A: CONNECTIONS

“XLR” CONNECTORS

Mackie mixers use 3-pin female “XLR” connectors on all microphone inputs, with pin 1 wired to the grounded (earthed) shield, pin 2 wired to the “high” (“hot” or positive polarity) side of the audio signal and pin 3 wired to the “low” (“cold” or negative polarity) side of the signal (Figure A). All totally aboveboard and in full accord with the hallowed standards dictated by the AES (Audio Engineering Society).

Use a male “XLR”-type connector, usually found on the nether end of what is called a “mic cable,” to connect to a female XLR jack.

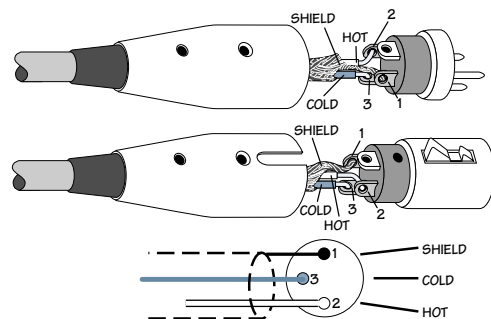

Figure A: XLR Connectors

1/4" TRS PHONE PLUGS AND JACKS

“TRS” stands for Tip-Ring-Sleeve, the three connections available on a “stereo” 1/4" or “balanced” phone jack or plug. See Figure B. TRS jacks and plugs are used in several different applications:

- Stereo Headphones, and rarely, stereo microphones and stereo line connections. When wired for stereo, a 1/4" TRS jack or

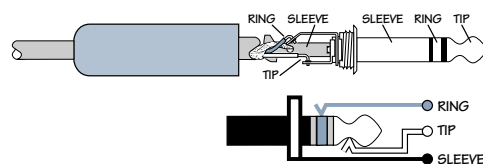

Figure B: 1/4" TRS Plugs

plug is connected tip to left, ring to right and sleeve to ground (earth). Mackie mixers do not directly accept 1-plug-type stereo microphones. They must be separated into a left cord and a right cord, which are plugged into the two mic preamps.

You can cook up your own adapter for a stereo microphone adapter. “Y” two cables out of a female 1/4" TRS jack to two male XLR plugs, one for the Right signal and one for the Left.

- Balanced mono circuits. When wired as a balanced connector, a 1/4" TRS jack or plug is connected tip to signal high (hot), ring to signal low (cold), and sleeve to ground (earth).
- Unbalanced Send/Return circuits. When wired as send/return “Y” connector, a 1/4" TRS jack or plug is connected tip to signal send (output from mixer), ring to signal return (input back into mixer), and sleeve to ground (earth).

1/4" TS PHONE PLUGS AND JACKS

“TS” stands for Tip-Sleeve, the two connections available on a “mono” 1/4" phone jack or plug (Figure C). TS jacks and plugs are used in many different applications, always unbalanced. The tip is connected to the audio signal and the sleeve to ground (earth). Some examples:

- Unbalanced microphones
- Electric guitars and electronic instruments
- Unbalanced line-level connections

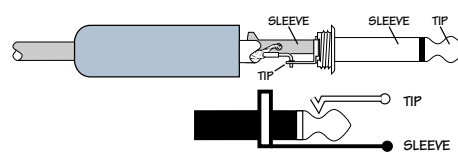

Figure C: TS Plug

SWITCHED ¼" PHONE JACKS

Switches can be incorporated into ¼" phone jacks, which are activated by inserting the plug. These switches may open an insert loop in a circuit, change the input routing of the signal or serve other functions. Mackie uses switches in the channel insert and bus insert jacks, input jacks and AUX returns. We also use these switches to ground the line-level inputs when nothing is plugged into them.

In most cases, the plug must be inserted fully to activate the switch. Mackie takes advantage of this in some circuits, specifying circumstances where you are to insert the plug only partially. See **Special Mackie Connections**, later in this section.

RCA PLUGS AND JACKS

RCA-type plugs (also known as phono plugs) and jacks are often used in home stereo and video equipment and in many other applications

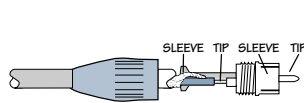

Figure D: RCA Plug

(Figure D). They are unbalanced and electrically identical to a ¼" TS phone plug or jack (See Figure C). Connect the signal to the center post and the ground (earth) or shield to the surrounding "basket."

UNBALANCING A LINE

In most studio, stage and sound reinforcement situations, there is a combination of balanced and unbalanced inputs and outputs on the various pieces of equipment. This usually will not be a problem in making connections.

- When connecting a balanced output to an unbalanced input, be sure the signal high (hot) connections are wired to each other, and that the balanced signal low (cold) goes to the ground (earth) connection at the unbalanced input. In most cases, the

balanced ground (earth) will also be connected to the ground (earth) at the unbalanced input. If there are ground-loop problems, this connection may be left disconnected at the balanced end.

- When connecting an unbalanced output to a balanced input, be sure that the signal high (hot) connections are wired to each other. The unbalanced ground (earth) connection should be wired to the low (cold) and the ground (earth) connections of the balanced input. If there are ground-loop problems, try connecting the unbalanced ground (earth) connection only to the input low (cold) connection, and leaving the input ground (earth) connection disconnected.

In some cases, you will have to make up special adapters to interconnect your equipment. For example, you may need a balanced XLR female connected to an unbalanced ¼" TS phone plug.

SPECIAL MACKIE CONNECTIONS

The balanced-to-unbalanced connection has been anticipated in the wiring of Mackie jacks. A ¼" TS plug inserted into a ¼" TRS balanced input, for example, will automatically unbalance the input and make all the right connections. Conversely, a ¼" TRS plug inserted into a ¼" unbalanced input will automatically tie the ring (low or cold) to ground (earth).

TRS Send/Receive Insert Jacks

Mackie's single-jack inserts are the three-conductor, TRS-type ¼" phone. They are unbalanced, but have both the mixer output (send) and the mixer input (return) signals in one connector (See Figure F).

The sleeve is the common ground (earth) for both signals. The send from the mixer to the external unit is carried on the tip, and the return from the unit to the mixer is on the ring.

Using the Send Only on an Insert Jack

If you insert a TS (mono) ¼" plug only partially (to the first click) into a Mackie insert jack, the plug will not activate the jack switch and will not open the insert loop in the circuit (thereby allowing the channel signal to continue on its merry way through the mixer).

This allows you to tap out the channel or bus signal at that point in the circuit without interrupting normal operation.

If you push the ¼" TS plug in to the second click, you will open the jack switch and create a direct out, which does interrupt the signal in that channel. See Figure E.



NOTE: Do not overload or short-circuit the signal you are tapping from the mixer. That will affect the internal signal.

MACKIE STEREO INPUTS AND RETURNS: Mono, Stereo, Whatever

Stereo line inputs and stereo AUX returns are a fine example of the Mackie philosophy (which we just made up) of Maximum Flexibility with Minimum Headache. The inputs and returns will automatically be mono or stereo, depending upon how you use the jacks. Here's how it works:

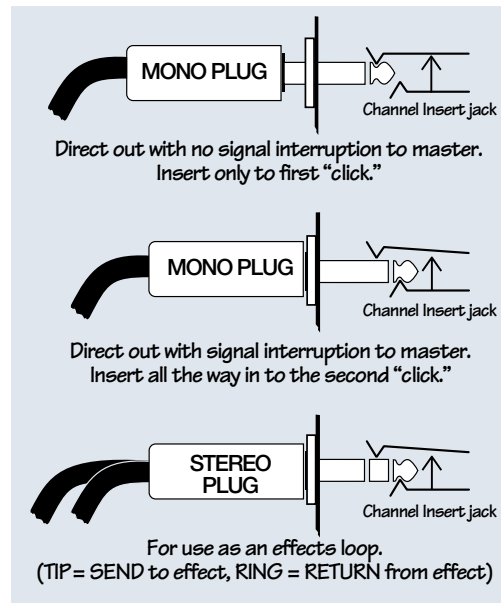

Figure E

A mono signal should be patched into the input or return jack labeled Left (MONO). The signal will be routed to both the left and right sides of the return circuit, and will show up in the center of the stereo pair of buses it's assigned to, or it can be "panned" with the Balance control.

A stereo signal, having two plugs, should be patched into the LEFT (MONO) and the RIGHT input or return jacks. A jack switch in the RIGHT jack will disable the mono function, and the signals will show up in stereo.

A mono signal connected to the RIGHT jack will show up in the right bus only. You probably will only want to use this sophisticated effect for special occasions (weddings, bar mitzvahs, Rush Limbaugh's birthday party, etc.)

MULTS AND "Y"s

A mult or "Y" connector allows you to route one output to two or more inputs by simply providing parallel wiring connections. You can make "Y"s and mults for the outputs of both unbalanced and balanced circuits.



Remember: Only mult or "Y" an output into several inputs. If you need to combine several outputs into one input, you must use a mixer, not a mult or a "Y."

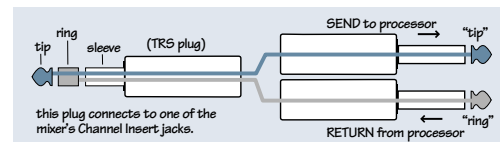

Figure F

MACKIE

1402-VLZ PRO

14-CHANNEL MIC/LINE MIXER

WITH PREMIUM XDR™ MIC PREAMPLIFIERS

Session: _____
Date: _____

 MIC 1 XDR MIC PFE +5VDC MIC PFE	 BAL UNBAL L R	 LOW CUT 18dB/OCT PHASE	 LINE IN 1 TRIM
 MIC 2 XDR MIC PFE +5VDC MIC PFE	 BAL UNBAL L R	 LOW CUT 18dB/OCT PHASE	 LINE IN 2 TRIM
 MIC 3 XDR MIC PFE +5VDC MIC PFE	 BAL UNBAL L R	 LOW CUT 18dB/OCT PHASE	 LINE IN 3 TRIM
 MIC 4 XDR MIC PFE +5VDC MIC PFE	 BAL UNBAL L R	 LOW CUT 18dB/OCT PHASE	 LINE IN 4 TRIM
 MIC 5 XDR MIC PFE +5VDC MIC PFE	 BAL UNBAL L R	 LOW CUT 18dB/OCT PHASE	 LINE IN 5 TRIM
 MIC 6 XDR MIC PFE +5VDC MIC PFE	 BAL UNBAL L R	 LOW CUT 18dB/OCT PHASE	 LINE IN 6 TRIM

 LEFT/MONO 1 2	 RIGHT	 ALL BAL/UNBAL 1 2	 TAPES INPUT L R	 TAPES OUTPUT	 BAL UNBAL L R MAIN OUT
 STEREO AUX RETURN 1 2	 AUX SEND				

NOTES:

 AUX 1 MASTER SELECT	 AUX 1 MONITOR	 AUX 1 NORMALIZED	 AUX 2 RETURN
CR/SOURCE <input type="radio"/> MAIN MIX <input type="radio"/> ALT 3-4 <input type="radio"/> TAPE <input type="radio"/> ASSIGN TO MAIN MIX <input type="radio"/> SOLO <input type="radio"/> MUTE <input type="radio"/> PHANTOM POWER			
EQ HI 12kHz MID 2.5kHz LOW 80Hz			
PAN L R			
LEVEL 0 2 4 7 10 14 17 20 23 26 29 30			
CTL ROOM/SUBMIX <input type="radio"/> SOLO <input type="radio"/> MUTE <input type="radio"/> ALT 3-4			
MAIN MIX <input type="radio"/> SOLO <input type="radio"/> MUTE <input type="radio"/> ALT 3-4			

1 <input type="radio"/> MUTE <input type="radio"/> ALT 3-4	2 <input type="radio"/> MUTE <input type="radio"/> ALT 3-4	3 <input type="radio"/> MUTE <input type="radio"/> ALT 3-4	4 <input type="radio"/> MUTE <input type="radio"/> ALT 3-4	5 <input type="radio"/> MUTE <input type="radio"/> ALT 3-4	6 <input type="radio"/> MUTE <input type="radio"/> ALT 3-4	7-8 <input type="radio"/> MUTE <input type="radio"/> ALT 3-4	9-10 <input type="radio"/> MUTE <input type="radio"/> ALT 3-4	11-12 <input type="radio"/> MUTE <input type="radio"/> ALT 3-4	13-14 <input type="radio"/> MUTE <input type="radio"/> ALT 3-4
 AUX MON/EFX									
 EQ HI 12kHz, MID 2.5kHz, LOW 80Hz									
 PAN L R									
 SOLO, MUTE									

COLOPHON

(Roll credits please) Manual written by Jeff Gilbert, based on a short story by Ron Koliha, now a major Broadway Musical. Manual then defaced with proofreading pens in the hands of Mackie's legendary Tech Support staff. Manual composed on a rinky-dink PC using a low-budget word processor, then converted to this amazing piece of work using a 13-story 1000 gigawhopper Macintosh operated by Mackie's notorious Advertising staff (most notably Becky Priebe). Please, feel free to let us know if you find an error or stumble over a confusing paragraph. Thank you for reading the entire manual (we know you have, or you wouldn't be here).



Mackie, the "Running Man" figure, VLZ and XDR are trademarks or registered trademarks of Mackie Designs Inc. Other brand names mentioned are trademarks or registered trademarks of their respective holders and are hereby acknowledged.

© 2003 Mackie Designs Inc.
All Rights Reserved.

MACKIE.®

1402-VLZ PRO LIMITED WARRANTY

Please keep your sales receipt in a safe place.

A. Mackie warrants all materials, workmanship and proper operation of this product for a period of **three years** from the original date of purchase. If any defects are found in the materials or workmanship or if the product fails to function properly during the applicable warranty period, Mackie, at its option, will repair or replace the product. Labor for replacing all potentiometers and switches is covered for the first year, after which it is excluded from warranty coverage and may be billed to you. **This warranty applies only to equipment sold and delivered within the U.S. by Mackie or its authorized dealers.**

B. Failure to register online or return the product registration card will not void the 3-year warranty.

C. Service and repairs of Mackie products are to be performed **only** at the factory (see D below) OR at an Authorized Mackie Service Center (see E below). Unauthorized service, repairs, or modification will void this warranty.

D. To obtain factory service:

1. Call Mackie at 800/258-6883, 8AM to 5PM Monday through Friday (Pacific Time) to get a Return Authorization (RA). Products returned without an RA number will be refused.

2. Pack the product in its original shipping carton. If you do not have the carton, just ask for one when you get your RA number, and we'll send a shipping carton out promptly. More information on packing can be found in the *Service* section of this manual. Do not use "packing peanuts," shredded newspapers, or other material with small particles, old underwear, or socks. Please seal the Mackie product in a plastic bag.

3. Also include a note explaining exactly how to duplicate the problem, a copy of the sales receipt with price and date showing, and your return street address (no P.O. boxes or route numbers, please!). If we cannot duplicate the problem at the Mackie Factory or establish the starting date of your Limited Warranty, we may, at our option, charge for service time.

4. Ship the product in its original shipping carton, **freight prepaid** to:

Mackie Designs
Service Department
16220 Wood-Red Rd. NE
Woodinville, WA 98072 USA

IMPORTANT: Make sure that the RA number is plainly written on the shipping carton.

E. To obtain service from an Authorized Mackie Service Center:

1. Call Mackie at 800/258-6883, 8AM to 5PM Monday through Friday (Pacific Time) to get:

1) The name and address of your nearest Mackie Authorized Service Center and 2) A return authorization (RA). You must have an RA number before taking your unit to a service center.

2. Make sure that you have a copy of your product's sales receipt from the store where you bought the product. It is necessary to establish purchase date and thus determine whether or not your product is still under warranty. If you can't find it, the Authorized Service Center may charge you for repairs even if your product is still covered by Mackie's 3-Year Limited Warranty.

3. Make sure that the problem can be duplicated. If you bring your product to an Authorized Service Center and they can't find anything wrong with it, you may be charged a service fee.

4. If the Mackie Authorized Service Center is located in another city, pack the product in its original shipping carton. More information on packing can be found in the *Service* section of this manual.

5. Contact the Mackie Authorized Service Center to arrange service or bring the product to them.

F. Mackie and Mackie Authorized Service Centers reserve the right to inspect any products that may be the subject of any warranty claims before repair or replacement is carried out. Mackie and Mackie Authorized Service Centers may, at their option, require proof of the original date of purchase in the form of a dated copy of the original dealer's invoice or sales receipt. Final determination of warranty coverage lies solely with Mackie Designs Inc. or its Authorized Service Centers.

G. Any Mackie product deemed eligible for repair or replacement under the terms of this warranty will be repaired or replaced within thirty days of receipt by Mackie. Mackie may use refurbished parts for repair or replacement of any product. Products returned to Mackie that do not meet the terms of this Warranty will be repaired and returned C.O.D. with billing for labor, materials, return freight, and insurance. Products repaired under warranty at Mackie's factory will be returned freight prepaid by Mackie to any location within the boundaries of the USA.

H. Mackie warrants all repairs performed for 90 days or for the remainder of the original warranty period. Mackie assumes no responsibility for the quality or timeliness of repairs performed by Mackie Authorized Service Centers.

I. This warranty is extended to the original purchaser and to anyone who may subsequently purchase this product within the applicable warranty period.

J. This is your sole warranty. Mackie does not authorize any third party, including any dealer or sales representative, to assume any liability on behalf of Mackie Designs or to make any warranty for Mackie Designs.

K. THE WARRANTY GIVEN ON THIS PAGE IS THE SOLE WARRANTY GIVEN BY MACKIE AND IS IN LIEU OF ALL OTHER WARRANTIES, EXPRESS AND IMPLIED, INCLUDING THE WARRANTIES OF MERCHANTABILITY AND FITNESS FOR A PARTICULAR PURPOSE. THE WARRANTY GIVEN ON THIS PAGE SHALL BE STRICTLY LIMITED IN DURATION TO ONE YEAR FROM THE DATE OF ORIGINAL PURCHASE FROM AN AUTHORIZED MACKIE DEALER. UPON EXPIRATION OF THE APPLICABLE WARRANTY PERIOD, MACKIE SHALL HAVE NO FURTHER WARRANTY OBLIGATION OF ANY KIND. MACKIE SHALL NOT BE LIABLE FOR ANY INCIDENTAL, SPECIAL, OR CONSEQUENTIAL DAMAGES THAT MAY RESULT FROM ANY DEFECT IN THE MACKIE PRODUCT OR ANY WARRANTY CLAIM. Some states do not allow exclusion or limitation of incidental, special, or consequential damages or a limitation on how long warranties last, so some of the above limitations and exclusions may not apply to you. This warranty provides specific legal rights and you may have other rights which vary from state to state.



MACKIE.®

Mackie Designs Inc.

16220 Wood-Red Road NE • Woodinville, WA 98071 • USA

US and Canada: 800.898.3211

Europe, Asia, Central and South America: 425.487.4333

Middle East and Africa: 31.20.654.4000

Fax: 425.487.4337 • www.mackie.com

E-mail: sales@mackie.com