

Automatic Multimeter PM2521

Operating Manual/Gebrauchsanleitung/Notice d'Emploi

9499 470 17901

820329/02/...

S&I
Scientific & Industrial Equipment Division



PHILIPS

Automatic Multimeter PM2521

Operating Manual/Gebrauchsanleitung/Notice d'Emploi

9499 470 17901

820329/02/...

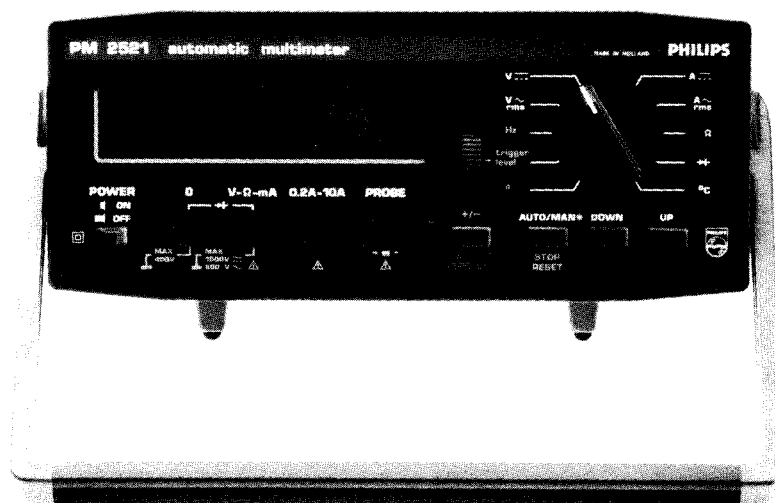

ST3523



PHILIPS

IMPORTANT

In correspondence concerning this instrument, please quote the type number and serial number as given on the type plate.

NOTE: *The design of this instrument is subject to continuous development and improvement. Consequently, this instrument may incorporate minor changes in detail from the information contained in this manual.*

SAFETY INSTRUCTIONS. This equipment had been built and tested according to safety specifications for electronic measuring equipment laid down by DIN 57411 part 1/2.80, VDE 0411 Part 1/2.80, IEC 348-II, and has left the factory in perfect condition from a safety point of view. In order to maintain this condition and to ensure the safe operation, the user must follow the instructions and warning notices contained in the directions for use. Prior to use after storage and transport, the equipment should first be examined for any mechanical faults. If there is any doubt that the safety measures are no longer adequate, their effectiveness should be checked. If its safety can no longer be guaranteed, the equipment should be taken out of service and safeguarded against further use. Before opening, the equipment should be disconnected from all electrical sources. Service and repair work should only be carried out by experienced qualified personnel and by following the standard safety procedure. This equipment belongs to safety class II . Only the approved fuses must be used. The use of repaired fuses and the shorting of the fuse holder is not permitted.

WICHTIG

Bei Schriftwechsel über dieses Gerät wird gebeten, die genaue Typenbezeichnung und die Gerätenummer anzugeben. Diese befinden sich auf dem Leistungsschild.

BEMERKUNG: *Die Konstruktion und Schaltung dieses Geräts wird ständig weiterentwickelt und verbessert. Deswegen kann dieses Gerät von den in dieser Anleitung stehenden Angaben abweichen.*

SICHERHEITSHINWEISE. Dieses Gerät ist gemäss DIN 57411 Teil 1/2.80, VDE 0411 Teil 1/2.80, IEC 348-II, Schutzmassnahmen für elektronische Messgeräte, gebaut und geprüft und hat das Werk insicherheitstechnisch einwandfreiem Zustand verlassen. Um diesem Zustand zu erhalten und einen gefahrlosen Betrieb sicher zu stellen; muss der Anwender die Hinweise und Warnmerke beachten, die in dieser Gebrauchsanleitung enthalten sind. Vor der Inbetriebnahme nach Lagerung und Transport ist darauf zu achten, dass das Gerät keine mechanischen Schäden aufweist. Besteht der Verdacht, dass die Schutzmassnahmen nicht mehr ausreichend wirksam sind, ist deren Wirksamkeit zu prüfen. Ist der Schutz nicht mehr sichergestellt, so ist das Gerät ausser Betrieb zu nehmen und gegen Inbetriebnahme zu sichern. Das Gerät ist vor dem Öffnen von allen Spannungsquellen zu trennen. Wartungs- und Überholungsarbeiten dürfen nur unter Beachtung der gebotenen Vorsichtsmassnahmen durch eingearbeitete Fachleute ausgeführt werden. Dieses Gerät ist ein Gerät der Schutzklasse II, . Es dürfen nur die vorgeschriebenen Sicherungen verwendet werden. Die Verwendung reparierter Sicherungen und das Kurzschliessen des Sicherungshalters sind nicht zulässig.

IMPORTANT

RECHANGE DES PIÈCES DÉTACHÉES (Réparation)

Dans votre correspondance et dans vos réclamations se rapportant à cet appareil, veuillez TOUJOURS indiquer le numéro de type et le numéro de série qui sont marqués sur la plaquette de caractéristiques.

REMARQUES: *Cet appareil est l'objet de développements et améliorations continus. En conséquence, certains détails mineurs peuvent différer des informations données dans la présente notice d'emploi et d'entretien.*

REGLES DE SECURITE. Cet appareil a été construit et testé suivant les normes DIN 57411, première partie /2.80, VDE 0411, première partie /2.80, IEC 348-II mesures de protection pour appareils électroniques de mesure, et il a quitté l'usine dans un état impeccable du point de vue de la technique de sécurité. Pour maintenir cet état et s'assurer d'un fonctionnement sans danger, l'utilisateur doit prendre en considération les instructions et les avertissements qui sont contenus dans le présent mode d'emploi. Avant sa mise en service à la suite de l'entreposage et du transport, il convient de veiller à ce que l'appareil ne présente aucun endommagement mécanique. Si l'on soupçonne que les mesures de protection ne sont plus suffisamment efficaces, il y a lieu de vérifier leur efficacité. Au cas où la protection n'est plus assurée, l'appareil doit être mis hors service et des dispositions doivent être prises pour garantir qu'il ne sera pas utilisé. Avant d'être ouvert, l'appareil doit être isolé de toute source de tension. Les travaux d'entretien et de remise en état ne doivent être exécutés qu'en respectant les mesures de précaution proposées par un personnel compétent. Cet appareil est un appareil de la classe de protection II, . Seuls, les fusibles prescrits peuvent être utilisés. L'utilisation de fusibles réparés et le court-circuitage du porte-fusibles sont interdits.

CONTENTS	Page
1. INTRODUCTION	13
2. TECHNICAL DATA	14
2.1. Measuring performance	14
2.1.1. Direct voltage measurements	14
2.1.2. Alternating voltage measurements	15
2.1.3. Direct current measurements	16
2.1.4. Alternating current measurements	17
2.1.5. dB measurements	18
2.1.6. Resistance measurements	19
2.1.7. Diode measurements	20
2.1.8. Temperature measurements	20
2.1.9. Frequency measurements	21
2.1.10. Time measurements	22
2.1.11. Trigger level	23
2.2. General data	24
2.2.1. Conversion characteristics (ADC)	24
2.2.2. Visual representation of the display	24
2.2.3. Operation conditions	24
2.2.3.1. Climatic conditions	24
2.2.3.2. Mechanical conditions	24
2.2.4. Mains supply conditions	25
2.2.4.1. Mains supply voltage	25
2.2.4.2. Mains supply frequency	25
2.2.4.3. Power consumption	25
2.2.5. Input terminals arrangement	25
2.2.6. Time function (ADC)	25
2.2.7. Calibration	25
2.2.8. Mechanical	25
2.2.9. Safety	25
3. ACCESSORIES	26
3.1. Accessories supplied with the PM2521	26
3.2. Optional available accessories	26
3.2.1. Summary	26
3.2.2. Specifications of the optional accessories	26
3.2.2.1. High Tension (HT) probe PM9246	26
3.2.2.2. Shunt PM9244 and Current transformer PM9245	26
3.2.2.3. Data Hold probe PM9263	27
3.2.2.4. Pt-100 temperature probe PM9249	27
3.2.2.5. High frequency probe PM9210 and accessory set PM9212	28
3.2.2.6. Dimensions of 19 inch rackmounting set	28

	Page
4. PRINCIPLE OF OPERATION	29
4.1. Analog section	29
4.1.1. Measuring voltages, currents, resistances and diodes	29
4.1.2. Measuring time and frequency	29
4.1.3. Measuring temperatures	29
4.1.4. dB measurements	29
4.1.5. Measurements in relative reference mode	29
4.1.6. Control of the analog section	29
4.1.7. ADC	29
4.2. Control section	30
4.3. Display section	30
5. INSTALLATION	31
5.1. Mains supply	31
5.1.1. Safety instructions	31
5.1.2. Replacing the mains fuse	31
5.1.3. Adaption to the mains voltage	31
5.1.4. Adaption to the mains frequency	31
6. OPERATION	32
6.1. Switching-on	32
6.2. Controls	32
6.2.1. Front panel	32
6.2.2. Rear panel	34
6.3. Zero setting	34
6.4. Measuring	35
6.4.1. Standard measurements	35
6.4.1.1. Direct voltage measurements (V_{DC})	35
6.4.1.2. Alternating voltage measurements ($V_{\text{AC rms}}$)	36
6.4.1.3. Decibel measurements (dB)	37
6.4.1.4. Direct current measurements (A_{DC})	38
6.4.1.5. Alternating current measurements ($A_{\text{AC rms}}$)	39
6.4.1.6. Resistance measurements (Ω)	40
6.4.1.7. Diode measurements (\rightarrow)	41
6.4.1.8. Temperature measurements ($^{\circ}\text{C}$)	42
6.4.1.9. Frequency measurements (Hz)	43
6.4.1.10. Time measurements (s)	45
6.4.1.11. Peak voltage measurements	48
6.4.2. Extended capabilities (optional)	50
6.4.2.1. High tension measurements	50
6.4.2.2. High current measurements (A_{DC} and $A_{\text{AC rms}}$)	51
6.4.2.3. Data Hold measurements	52
6.4.2.4. High frequency measurements	53

LIST OF FIGURES

	Page
Fig. 1. Accessories supplied with the PM2521	126
Fig. 2. HT probe PM9246	126
Fig. 3. Shunt PM9244	126
Fig. 4. Current transformer PM9245	126
Fig. 5. Data Hold probe PM9263	126
Fig. 6. Pt-100 temperature probe PM9249	126
Fig. 7. HF probe PM9210	130
Fig. 8. Accessory set PM9212	130
Fig. 9. Dimensions for 19 inch rackmounting set	130
Fig. 10. Basic built-up of PM2521	134
Fig. 11. Block diagram of PM2521	134
Fig. 12. Removing the top cover	138
Fig. 13. Adapting the mains transformer	138
Fig. 14. dB measurements	37
Fig. 15. Temperature probe connection	42
Fig. 16. Trigger level selection in function Hz	44
Fig. 17. Normal mode trigger level selection in function s	45
Fig. 18. Special mode trigger level selection in function s	45
Fig. 19. Data hold connection	47
Fig. 20. Trigger level selection in peak voltage measurement mode	49
Fig. 21. Peak voltage measurements	49
Fig. 22. Front panel	142
Fig. 23. Rear panel	142
Fig. 24. Measuring set-up for HT probe PM9246	146
Fig. 25. Measuring set-up for shunt PM9244	146
Fig. 26. Measuring set-up for current transformer PM9245	150
Fig. 27. Measuring set-up for data hold probe PM9263	150
Fig. 28. Measuring set-up for high frequency probe PM9210	150

INHALT	Seite
1. EINLEITUNG	55
2. TECHNISCHE DATEN	56
2.1. Messleistung	56
2.1.1. Gleichspannungsmessungen	56
2.1.2. Wechselspannungsmessungen	57
2.1.3. Gleichstrommessungen	58
2.1.4. Wechselstrommessungen	59
2.1.5. dB Messungen	60
2.1.6. Widerstandsmessungen	61
2.1.7. Diodenmessungen	62
2.1.8. Temperaturmessungen	62
2.1.9. Frequenzmessungen	63
2.1.10. Zeitmessungen	64
2.1.11. Triggerpegel	65
2.2. Allgemeine Daten	66
2.2.1. Analog-Digital Umsetzung (ADC)	66
2.2.2. Sichtanzeige	66
2.2.3. Betriebsbedingungen	66
2.2.3.1. Klimatische Bedingungen	66
2.2.3.2. Mechanische Bedingungen	66
2.2.4. Betriebsbedingung Speisung nach IEC359	67
2.2.4.1. Netzspannung	67
2.2.4.2. Netzfrequenz	67
2.2.4.3. Leistungsaufnahme	67
2.2.5. Anordnung der Eingangsklemmen	67
2.2.6. Zeitfunktion (ADC)	67
2.2.7. Kalibrierung	67
2.2.8. Mechanische Daten	67
2.2.9. Schutz	67
3. ZUBEHÖREN	68
3.1. Zubehören im Lieferumfang des PM2521 enthalten	68
3.2. Wahlweise erhältliches Zubehör	68
3.2.1. Zusammenfassung	68
3.2.2. Spezifikationen des Wahlzubehörs	68
3.2.2.1. Hochspannungs-Messkopf PM9246	68
3.2.2.2. Shunt PM9244 und Stromwandler PM9245	68
3.2.2.3. Messkopf PM9263 mit "Data-hold"	69
3.2.2.4. Pt-100 Temperaturmeszfühler PM9249	69
3.2.2.5. HF-Tastkopf PM9210 und Zubehörsatz PM9212	70
3.2.2.6. Abmessungen für 19 inch Gestelleinbau	70

	Seite
4. FUNKTIONSPRINZIP	71
4.1. Analogteil	71
4.1.1. Messung von Spannung, Strom, Widerstand und Dioden	71
4.1.2. Messung von Zeit und Frequenz	71
4.1.3. Messung von Temperaturen	71
4.1.4. dB-Messungen	71
4.1.5. Messung in relativer Referenz Betriebsart	71
4.1.6. Steuerung des Analogteils	71
4.1.7. Analog-Digital Umsetzer (ADC)	71
4.2. Steuerteil	72
4.3. Anzeigeteil	72
5. INBETRIEBNAHME	73
5.1. Netzspannung	73
5.1.1. Sicherheitsvorkehrungen	73
5.1.2. Ersetzen der Netzsicherung	73
5.1.3. Anpassung an die Netzspannung	73
5.1.4. Anpassung an die Netzfrequenz	73
6. BETRIEB	74
6.1. Einschalten	74
6.2. Bedienungselemente	74
6.2.1. Frontplatte	74
6.2.2. Rückwand	76
6.3. Nullsetzen	76
6.4. Messen	77
6.4.1. Standardmessungen	77
6.4.1.1. Gleichspannungsmessungen (V_{DC})	77
6.4.1.2. Wechselspannungsmessungen ($V_{\text{AC rms}}$)	78
6.4.1.3. dB-Messungen (dB)	79
6.4.1.4. Gleichstrommessungen (A_{DC})	80
6.4.1.5. Wechselstrommessungen ($A_{\text{AC rms}}$)	81
6.4.1.6. Widerstandsmessungen	82
6.4.1.7. Diodenmessungen (\rightarrow)	83
6.4.1.8. Temperaturmessungen ($^{\circ}\text{C}$)	84
6.4.1.9. Frequenzmessungen (Hz)	85
6.4.1.10. Zeitmessungen (s)	87
6.4.1.11. Spitzenspannungsmessungen	90
6.4.2. Erweiterte Möglichkeiten (wahlweise)	92
6.4.2.1. Messung von Hochspannungen	92
6.4.2.2. Messung hoher Ströme (A_{DC} und $A_{\text{AC rms}}$)	93
6.4.2.3. Messungen mit "Data hold"	94
6.4.2.4. Hochfrequenzmessungen	95

BILDVERZEICHNIS

Seite

Abb. 1. Mit dem PM2521 gelieferte Zubehör	126
Abb. 2. Hochspannungs Messkopf PM9246	126
Abb. 3. Shunt PM9244	126
Abb. 4. Stromwandler PM9245	126
Abb. 5. Meszkopf PM9263 mit "Data Hold"	126
Abb. 6. Pt-100 Temperaturfühler PM9249	126
Abb. 7. HF Tastkopf PM9210	130
Abb. 8. Zubehörsatz PM9212	130
Abb. 9. Abmessung für 19 inch Gestelleinbau	130
Abb. 10. Grundaufbau des PM2521	134
Abb. 11. Blockschaltbild des PM2521	134
Abb. 12. Abnehmen der Abdeckel	138
Abb. 13. Anpassen des Netztransformators	138
Abb. 14. dB-Messungen	79
Abb. 15. Temperaturfühler Anschluss	84
Abb. 16. Triggerpegelwahl in Funktion Hz	86
Abb. 17. Normale Betriebsart für Triggerpegelwahl in Funktion s	87
Abb. 18. Spezielle Betriebsart für Triggerpegelwahl in Funktion s	87
Abb. 19. Data Hold Anschluss	89
Abb. 20. Triggerpegelwahl bei Messung von Spitzenspannungen	91
Abb. 21. Messung von Spitzenspannungen	91
Abb. 22. Frontplatte	142
Abb. 23. Rückwand	142
Abb. 24. Messanordnung für Hochspannungsmesskopf PM9246	146
Abb. 25. Messanordnung für Shunt PM9244	146
Abb. 26. Messanordnung für Stromwandler PM9245	150
Abb. 27. Messanordnung für Messkopf PM9263 mit "Data Hold"	150
Abb. 28. Messanordnung für Hochfrequenz Tastkopf PM9210	150

Operating manual

1. INTRODUCTION

The PM 2521 is a microcomputer controlled digital multimeter. The type of microcomputer used is a 8035 with a 4k external ROM. Thanks to the microcomputer extra measuring functions are incorporated, in addition to the standard multimeter measuring functions. These extra measuring functions make it possible to measure the standard multimeter measuring signals in other units.

The standard multimeter functions of the PM 2521 are:

Alternating voltage ($V \sim$ rms)	Direct current ($A \overline{\text{---}}$)
Direct voltage ($V \overline{\text{---}}$)	Diodes ($\rightarrow +$)
Alternating current ($A \sim$ rms)	Resistance (Ω)

The extra measuring functions of the PM 2521 are:

Temperature Pt-100 ($^{\circ}\text{C}$)	Trigger level (+/-)
Frequency (Hz)	Decibels (dB)
Time (s)	Relative reference (zero set)

A combination of the trigger level function and the time or frequency function, make selective measurements possible.

The trigger level function itself also enables peak voltage measurements.

The relative reference function offers the possibility to select a predetermined relative reference point. Each subsequent reading will indicate the positive and negative deviation of the relative reference level.

Each measuring function is subdivided into a number of ranges. For range switching a selection can be made between manual or automatic range selection.

To get an optimum reading in the ac ranges an ac coupled rms convertor is built in the PM 2521. The periodical self-calibration of the PM 2521 ensures high accuracy over a long working period. The PM 2521 is equipped with a 5 digit display. As display a liquid crystal display is used. It gives a very clear reading, especially under strong light conditions.

Ordering number for the instruction sticker is 9499 470 16401

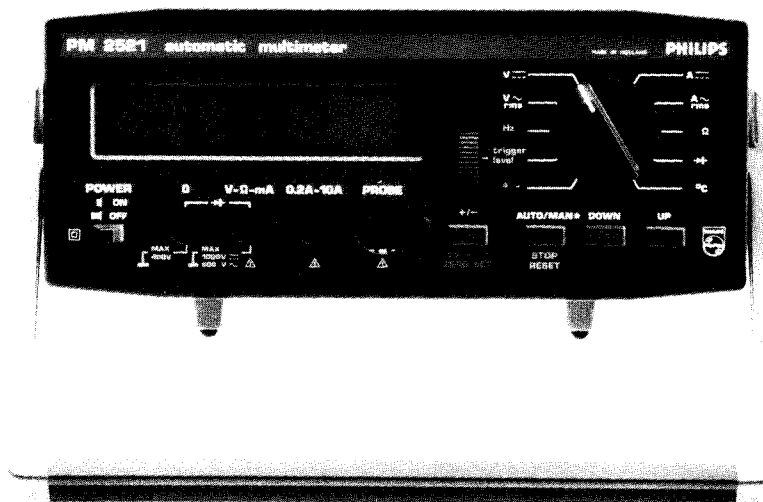

ST3523

2. TECHNICAL DATA

This apparatus has been designed and tested in accordance with IEC publication 348, Safety Requirements for Electronic Measuring Apparatus, and has been supplied in a safe condition. The present instruction manual contains some information and warnings which have to be followed by the user to ensure safe operation and to retain the apparatus in a safe condition.

All values mentioned in this description are nominal; those given with tolerances are binding and guaranteed by the manufacturer.

Manufacturer	NV Philips MIG S & I
Type number	PM 2521
Designation	Digital multimeter
Measuring quantities	V $\overline{\quad}$, V \sim , A $\overline{\quad}$, A \sim , Ω , \blacktriangleright , s, Hz, $^{\circ}\text{C}$, V peak

2.1. MEASURING PERFORMANCE

2.1.1. Direct voltage measurements

Ranges

mV	200
V	2 - 20 - 200 - 2000 V

Maximum input voltage in range 2000 V

1000 V

Resolution

10 μV in range 200 mV

Number of representation units

21000

Accuracy

$\pm (0,03 \% \text{ of reading} + 0,01 \% \text{ of range})$

Temperature coefficient

$\pm 0,01 \% \text{ of reading } / ^{\circ}\text{C}$

Input impedance

Range	Input impedance
200 mV 2 V	20 M Ω //60 pF
20 V	11 M Ω //85 pF
200 V 2000 V	10 M Ω //95 pF

Offset current at input

<20 pA

Series Mode Rejection Ratio (SMRR)

86 dB for ac signals at 50 Hz $\pm 1 \%$
60 dB for ac signals at 60 Hz $\pm 1 \%$

Maximum Series Mode signal

2x range end value with exception of range 2000 V (1000 V)

Common Mode Rejection Ratio (CMRR)

100 dB for dc signals
100 dB for ac signals of 50 Hz or 60 Hz $\pm 1 \%$

Maximum Common Mode voltage

400 V, 560 V peak

Response time

0,7 s without ranging
1,5 s including ranging

Zero setting

Automatic zero setting of the ADC
Manual with zero potentiometer at the front of the PM 2521

Zero point drift

5 $\mu\text{V}/^{\circ}\text{C}$ between 0 $^{\circ}\text{C}$ and 35 $^{\circ}\text{C}$
20 $\mu\text{V}/^{\circ}\text{C}$ between 35 $^{\circ}\text{C}$ and 45 $^{\circ}\text{C}$

Relative reference setting

With pushbutton ZERO SET at the front of the PM 2521

Maximum input voltages

In all ranges:
 Between Hi and Lo 1000 V rms
 Between Hi and earth 1000 V rms
 Between Lo and earth 400 V rms
 Maximum VHz product 10^7

2.1.2. Alternating voltage measurements

Ranges

mV	200
V	2 20 200 2000

Maximum input voltage in range 2000 V

600 V

Resolution

10 μ V in range 200 mV

Measured value less than 0,5 % of range is displayed as zero

Number of representation units

21000

Accuracy

(valid between 3 % and 100 % of range)

Range 200 mV up to and including 200 V	
40 Hz - 500 Hz	$\pm (0,3\% \text{ of reading} + 0,15\% \text{ of range})$
at 20kHz	$\pm (1 \% \text{ of reading} + 0,15\% \text{ of range})$
at 100kHz	$\pm (5 \% \text{ of reading} + 1 \% \text{ of range})$

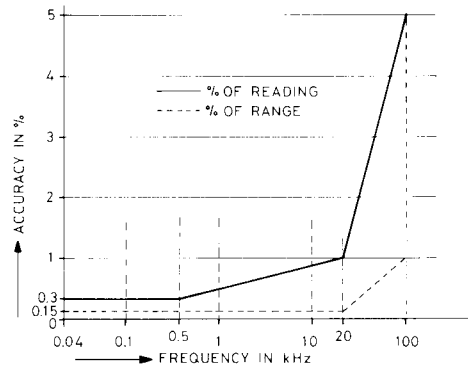

ST 3354

Temperature coefficient

Range 2000 V	
40 Hz - 60 Hz	$\pm (0,3\% \text{ of reading} + 0,15\% \text{ of range})$

$\pm (0,03 \% \text{ of reading} / ^\circ\text{C} + 0,01 \% \text{ of range} / ^\circ\text{C})$

Input impedance

Range	Input impedance
200 mV 2 V	20 M Ω //60 pF
20 V	11 M Ω //85 pF
200 V 2000 V	10 M Ω //95 pF

Common Mode Rejection Ration (CMRR)

100 dB for dc signals
 80 dB for ac signals 50 Hz or 60 Hz $\pm 1 \%$

AC detector

RMS convertor, ac coupled

Crest factor

2 at range end

Response time

1,5 s without ranging
 3 s including ranging

Maximum input voltage

In all ranges:
 Between Hi and Lo 600 V rms
 Between Hi and earth 1000 V rms
 Between Lo and earth 400 V rms
 Maximum dc voltage 400 V
 Maximum VHz product 10^7

2.1.3. Direct current measurements

Ranges

μA	2 20 200
mA	2 20 200
A	2 20

Maximum input current in range 20 A

10 A

Resolution

1 nA in range 2 μA

Number of representation units

2100

Accuracy

$\pm (0,2\% \text{ of reading} + 0,05\% \text{ of range})$

Temperature coefficient

$\pm (0,02\% \text{ of reading} / ^\circ\text{C} + 0,005\% \text{ of range} / ^\circ\text{C})$

Voltage drop over shunt

Range	Voltage drop
2 μA 20 μA 200 μA 2 mA	<2,5 mV
20 mA 200 mA	<25 mV
2 A 20 A	<250 mV

Response time

0,7 s without ranging
1,5 s including ranging

Protection

Range 2 μA - 20 mA; 250 V rms
Range 200 mA - 20 A are not protected
 $I_{\text{max.}} = 20 \text{ A}$ for 20 seconds

Maximum Common Mode voltage

400 V rms, 560 V peak

Maximum input voltages

In all ranges:
Between Hi and Lo 250 V rms
Between Hi and earth 400 V rms
Between Lo and earth 400 V rms

2.1.4. Alternating current measurements

Ranges

μ A	2	20	200
mA	2	20	200
A	2	20	

Maximum input current in range 20 A

10 A

Resolution

1 nA in range 2 μ A

Measured value less than 0,5 % of range is displayed as zero

Number of representation units

2100

Accuracy

40 Hz - 200 Hz \pm (0,4% of reading +0,15% of range)

(valid between 3 % and 100 % of range)

Temperature coefficient

\pm (0,03 % of reading / $^{\circ}$ C + 0,01 of range / $^{\circ}$ C)

Voltage drop over shunt

Range	Voltage drop	Frequency
2 μ A 20 μ A 200 μ A 2 mA	<2,5 mV	50 Hz
20 mA 200 mA	<25 mV	
2 A 20 A	<250 mV	

AC detector

RMS convertor, ac coupled

Crest factor

2 at range end

Response time

1 s without ranging

3 s including ranging

Protection

Range 2 μ A - 20 mA; 250 V rms

Range 200 mA - 20 A are not protected

I_{max} = 20A for 20 seconds

Maximum Common Mode voltage

400 V rms, 560 V peak

Maximum input voltage

In all ranges:

Between Hi and Lo 250 V rms

Between Hi and earth 400 V rms

Between Lo and earth 400 V rms

2.1.5. dB measurements (valid in function $V_{\sim rms}$)

Range	-57,7 dB . . . +57,7 dB
0 dB reference	1 mW in 600 Ω , 0,775 V or when selecting the relative reference function with pushbutton ZERO SET at the front of the PM 2521
Resolution	0,1 dB Measured value less than -57,7 dB is displayed as -99,9 dB
Number of representation units	999

Accuracy

Signals	Frequency	Accuracy
-31,7 dB ... +47 dB	40 Hz - 20kHz	$\pm 0,2$ dB
	20kHz - 100kHz	± 1 dB
-50 dB ... -31,7 dB	40 Hz - 20kHz	± 2 dB
-57,7 dB ... -50 dB	40 Hz - 20kHz	± 3 dB
> +47 dB	40 Hz - 500 Hz	$\pm 1,5$ dB

Temperature coefficient

0,02 dB / $^{\circ}$ C

Input impedance

Signals	Impedance
0 V - 1,8 V	20 M Ω //60 pF
1,8 V - 18 V	11 M Ω //85 pF
18 V - 600 V	10 M Ω //95 pF

Common Mode Rejection Ratio (CMRR)

100 dB for dc signals
80 dB ac signals 50 Hz or 60 Hz ± 1 %

AC detector

RMS convertor, ac coupled

crest factor

2 at range end

Response time

3s

Relative reference setting

With pushbutton ZERO SET at the front of the PM 2521

Maximum input voltages

In all ranges:

Between Hi and Lo 600 V rms

Between Hi and earth 1000 V rms

Between Lo and earth 400 V rms

Maximum dc voltage 400 V

Maximum VHz product 10^7

2.1.6. Resistance measurements

Ranges

Ω	200
$k\Omega$	2 20 200
$M\Omega$	2 20

Resolution

10 m Ω in range 200 Ω

Number of representation units

21000

Accuracy

Range	Accuracy
200 Ω 2 $k\Omega$ 20 $k\Omega$ 200 $k\Omega$	$\pm (0,2 \% \text{ or reading } +0,1 \% \text{ of range})$
2 $M\Omega$ 20 $M\Omega$	$\pm (1 \% \text{ or reading } +0,1 \% \text{ of range})$

Temperature coefficient

Range	Temperature coefficient
200 Ω 2 $k\Omega$ 20 $k\Omega$ 200 $k\Omega$	$\pm (0,02 \text{ of reading } /^{\circ}\text{C} + 0,01 \% \text{ of range } /^{\circ}\text{C})$
2 $M\Omega$ 20 $M\Omega$	$\pm (0,05 \% \text{ of reading } /^{\circ}\text{C} + 0,01 \% \text{ of range } /^{\circ}\text{C})$

Measuring current

Range	Measuring current
200 Ω	1 mA
2 $k\Omega$	1 mA
20 $k\Omega$	100 μA
200 $k\Omega$	10 μA
2 $M\Omega$	1 μA
20 $M\Omega$	100 nA

Maximum voltage

4 V

at the terminals with open input

Relative reference selection

With pushbutton ZERO SET at the front of the PM 2521

Polarity of the input terminals

- on Hi + on Lo

Response times

Range	Response time
200 Ω - 200 $k\Omega$	0,7 s without ranging 2,5 s including ranging
2 $M\Omega$	2 s without ranging
20 $M\Omega$	7 s without ranging

Protection

265 V rms

Maximum input voltages

In all ranges:

Between Hi and Lo 265 V rms

Between Hi and earth 400 V rms

Between Lo and earth 400 V rms

2.1.7. Diode measurements

Driving current	1 mA
Range	2 V
Resolution	100 μ V
Number of representation units	21000
Polarity of the input terminals	– on Hi + on Lo

Reading

	Forward	Reversed
Si	0.6000 - 0.9000 V	OL
Ge	0.1000 - 0.3000 V	OL

Relative reference setting

With pushbutton ZERO SET at the front of the PM 2521

Protection

265 V rms

Maximum input voltages

In all ranges:

Between Hi and Lo	265 V rms
Between Hi and earth	400 V rms
Between Lo and earth	400 V rms

2.1.8. Temperature measurementsAdditional needed for
temperature measurements

Optional Pt-100 temperature probe PM 9249

Temperature range

–50^o to +200 ^oC

Resolution

0,1^oCAccuracy
(excluding probe)

Range	Accuracy
0 ^o C ... +100 ^o C	± (1 % of reading + 0,2 ^o C)
–50 ^o C ... +200 ^o C	± (3 % of reading + 0,2 ^o C)

Relative reference setting

With pushbutton ZERO SET at the front of the PM 2521

2.1.9. Counter measurements (Hz)

Ranges

kHz	10	100
MHz	1	10

Range selection

Range 100 kHz, 1 MHz and 10 MHz; Manual or automatic
Range 10 kHz; Manual only

Resolution

0,1 Hz in range 10 kHz

Number of representation units

99999

Accuracy for counter measurements

Range	Accuracy
10 kHz 100 kHz 1 MHz	$\pm (0,005 \% \text{ of reading} + 0,001 \% \text{ of range})$
10 MHz	$\pm (0,01 \% \text{ of reading} + 0,001 \% \text{ of range})$

Gate time

Range	Gate time
10 kHz	10 s
100 kHz	1 s
1 MHz	100 ms
10 MHz	10 ms

Conversion rate

Range	Rate
10 kHz	1 conv./10 s
100 kHz 1 MHz 10 MHz	1 conv./s

Trigger mode

On positive going crossings of the + trigger level
On negative going crossings of the – trigger level

Counter sensitivity

DC to 1 MHz 150 mV peak
1 MHz to 10 MHz 300 mV peak
Resolution; 1 mV

Trigger level adjustment

With thumbwheel at the front of the PM 2521

2.1.10. Time measurements (s)

Ranges	Seconds	10 ¹	10 ²	10 ³	10 ⁴	10 ⁵
Resolution	100 μ s in the 10 ¹ s range					
Number of representation units	99999					
Accuracy for time measurements	\pm (0,005 % of reading +0,001 % of range)					
Counting frequency	100 kHz					
Hold off time	10 ms					
Start	By a crossing of the trigger level					
Stop	By a crossing of the trigger level or by depressing pushbutton STOP/RESET					
Reset	By depressing pushbutton STOP/RESET					
Sensitivity	DC ... 1 μ s pulse : 100 mV 1 μ s ... 100 ns pulse : 200 mV					
Trigger modes (Start/Stop)	On positive going crossings of the + trigger level On negative going crossing of the – trigger level With data hold probe PM 9263 On positive and negative crossings of the + trigger level On negative and positive crossings of the –trigger level					
Trigger level adjustment	With thumbwheel at the front of the PM 2521					

2.1.11. Trigger level

Ranges

V	2	20	200	2000
---	---	----	-----	------

Number of representation units

2100

Accuracy

(valid between 5 % and 100 % of range)

Range 2 V and 20 V

Frequency	Accuracy
DC - 500 Hz	$\pm (0,3 \% \text{ of reading} + 0,5 \% \text{ of range})$
500 Hz - 20 kHz	$\pm (1 \% \text{ of reading} + 0,5 \% \text{ of range})$
20 kHz - 100 kHz	$\pm (5 \% \text{ of reading} + 0,5 \% \text{ of range})$
100 kHz - 10 MHz	$\pm (30 \% \text{ of reading} + 0,5 \% \text{ of range})$

Range 200 V and 2000 V

Frequency	Accuracy
DC - 100 Hz	$\pm (0,3 \% \text{ of reading} + 0,5 \% \text{ of range})$
100 Hz - 10 kHz	$\pm (5 \% \text{ of reading} + 0,5 \% \text{ of range})$

Temperature coefficient

 $\pm 100 \mu\text{V} / ^\circ\text{C}$

Input impedance

Range	Impedance
2 V	20 M Ω //60 pF
20 V	11 M Ω //85 pF
200 V, 2000 V	10 M Ω //95 pF

Maximum input voltages

In all ranges:

Between Hi and Lo 1000 V rms

Between Hi and earth 1000 V rms

Between Lo and earth 400 V rms

Maximum VHz product 10^7

Trigger level adjustment

With thumbwheel at the front of the PM 2521 between 0 and end of range

Trigger level polarity

+ or - selected with +/- pushbutton at the front of the PM 2521

2.2. GENERAL DATA

2.2.1. Conversion characteristics (ADC)

Type of conversion	Linear
Operating principle	Repetitive triggered
Range setting	Automatically Manual by means of pushbuttons UP and DOWN
Polarity setting	Automatically in the functions V, A, °C, trigger level, dB and ZERO SET

2.2.2. Visual representation of the display

Number of digits	3½ in functions A $\overline{\sim}$ and A \sim , 4½ in functions V $\overline{\sim}$, V \sim , °C, Ω and \rightarrow + 5 in functions Hz and s.
------------------	---

Range changing		4½ digit function	3½ digit function
Range up		20200 ± 20	2020 ± 2
Range down		01800 ± 20	0180 ± 2

Means of representation of the output value	Liquid crystal display (LCD), height 13 mm Reflective, lit from front side
Means of polarity representation	Automatic + – and \sim in the LCD
Means of function representation	With the function selector on the textplate
Means of unit representation	Automatic in the LCD mV, V, kHz, MHz, s, °C, Ω , k Ω , M Ω , μ A, mA, A and db
Means of overload representation	LCD indicates OL
Means of decimal point representation	Automatic, depending on the selected range in the LCD
Means of ranging representation	Automatic in LCD * for manual ranging
Means of relative reference representation	Automatic in LCD Z.S
Data hold	With optional Data Hold probe PM 9263 With pushbutton STOP in function s
Range hold	With AUTO/MAN * ranging pushbutton

2.2.3. Operating conditions in accordance with IEC 359

2.2.3.1. Climatic conditions

In accordance with Group I of IEC 359 with extension of the temperature limits

Temperature

Reference temperature	23 °C ± 1 °C
Rated range of use	+0 °C ... +45 °C
Upper temperature limit	+45 °C
Limit range of storage and transport	–40 °C ... +70 °C

Humidity

Relative humidity	20 % ... 80 % RH, non-condensing
-------------------	----------------------------------

2.2.3.2. Mechanical conditions

In accordance with Group 2 of IEC 359

2.2.4. Mains supply conditions in accordance with IEC 359, Group S2

2.2.4.1. Mains supply voltage

Reference value	220 V, \pm 1 %
Rated range of use	220 V, \pm 10 %

Note:

Instrument can be altered for nominal mains voltage of 110 V and 240 V

2.2.4.2. Mains supply frequency

Reference value	50 Hz/60 Hz
Rated range of use	47 Hz ... 63 Hz

2.2.4.3. Power consumption

Power consumption	10 VA
-------------------	-------

2.2.5. Input terminals arrangement

Number of input terminals	Three x 4 mm terminals; 0, V- Ω - mA and 0,2 A - 10 A One 8 pole DIN socket; PROBE Asymmetrical, floating
---------------------------	--

2.2.6. Time function ADC

Conversion rate	2,5 conversions /s
Range changing time	62 ms
Recovery time after overload	Range 200 mV : max. 7 s Range 2 V - 2000 V : max. 1 s

2.2.7. Calibration

Recalibration interval	1 year
------------------------	--------

2.2.8. Mechanical

Dimensions	Height	95 mm
	Width	235 mm
	Depth	280 mm
Weight	2 kg	
Cabinet material	ABS	

2.2.9. Safety

Class II in accordance with IEC 348

3. ACCESSORIES

3.1. ACCESSORIES SUPPLIED WITH THE PM 2521 (Fig. 1, page 126)

- Measuring leads with testpins PM 9266 (1)
- Mains cable (2)
- Spare fuse 1x 125 mA FAST 110 V ... 240 V mains (3)
- Operating manual (4)

Note:

The spare fuse is located in the mains socket at the rear of the PM 2521.

3.2. OPTIONAL AVAILABLE ACCESSORIES

3.2.1. Summary

- High tension probe PM 9246
- High current shunt PM 9244 or current transformer PM 9245
- Data hold probe PM 9263
- Pt-100 temperature probe PM 9249
- High frequency probe PM 9210 and accessory set PM 9212

3.2.2. Specifications of the optional accessories

3.2.2.1. High Tension (HT) probe PM 9246 (Fig. 2, page 126)

The HT probe PM 9246 is suitable for measuring direct voltages up to 30 kV. The PM 9246 may be used for measuring instruments with an input impedance of 100 M Ω , 10 M Ω or 1,2 M Ω . (Selectable on the probe).

Maximum voltage	30 kV
Attenuation	1000x
Input impedance	600 M Ω \pm 5 %
Accuracy	\pm 3 % (Excluding accuracy of the PM 2521)
Relative humidity	20 % ... 80 %

Note:

Pay attention to safe earth connections

3.2.2.2. Shunt PM 9244 and Current transformer PM 9245 (Fig. 3 and Fig. 4, page 126)

Shunt PM 9244

With the PM 9244 it is possible to measure direct and alternating currents (max. 1 kHz) up to 31,6 A

Current range	10 A and 31,6 A
Output voltage	100 mV and 31,6 mV
Accuracy	100 mV \pm 10 %
(Excluding accuracy of the PM 2521)	31,6 mV \pm 3 %
Dissipation	Max. 3,16 W
Dimensions	Height 55 mm
	Width 140 mm
	Depth 65 mm

Current transformer PM 9245

With this transformer it is possible to measure alternating currents over 10 A up to 100 A

Transfer factor	1000x (100 A = 100 mA)
Transfer error	\pm 3 % (Excluding accuracy of the PM 2521)
Frequency range	45 Hz to 1 kHz
Maximum secondary voltage loss	200 mV
Maximum voltage with respect to earth	400 V ac.

Before measuring, connect the current-transformer to the instrument.
Avoid contamination of the core-parts.

3.2.2.3. Data Hold probe PM 9263 (Fig. 5 page 126)

INTRODUCTION

The PM 9263 is a DATA HOLD probe that can be used in combination with multimeters having data hold facilities on the DIN probe input. A switch ring on the probe is pushed forward to hold the data for display. Depending on the multimeter, voltage, resistance and current measurements can be made in combination with the probe.

TECHNICAL DATA

Maximum input voltages:		Data Hold by means of slide switch on the probe
Probe tip (V Ω) to common (0)	30 V rms VHz product < 10 ⁷	
Common (0) to earth	30 V rms	Temperature range
Probe tip (V Ω) to earth	30 V rms	Rated range of use -10 °C...+55 °C
V test	500 V ac	Limit range of storage and transport -25 °C...+70 °C
Maximum input current	200 mA	Relative humidity 10 %...80 % (non-condensing)
Input capacity	300 pF	
Resistance V Ω and 0 leads	130 M Ω	

ACCESSORIES

Delivered with the PM 9263

Accessory box containing:

• Zeroing lead	3	• Insulating cap	8
• 6 markings rings (red, white, blue).....	4	• Dual-in-line cap	9
• Probe holder	5	• 10 soldering test points	10
• Spring loaded test clip.....	6	• 2 Space probe tips	11
• Wrap pin connector	7	• Instruction manual	

Optional accessories

Accessories used with oscilloscope probes can be combined with this probe.

3.2.2.4. Pt-100 temperature probe PM 9249 (Fig. 6 page 126)

The Pt-100 temperature probe is a contact probe, suitable for measurement of surface temperatures between -60 °C and +200 °C.

Range	-60 °C to +200 °C
Accuracy (DIN 43760) Probe	- 60 °C to +100 °C \pm 0,55 °C
(Excluding accuracy of the PM 2521)	+100 °C to +200 °C \pm 1 °C

3.2.2.5. *High frequency probe PM 9210 and accessory set PM 9212 (Figs. 7 and 8, page 130)*

TECHNICAL DATA (excluding accuracy of the PM 2521)	PM 9210	PM 9210 + PM 9212
Frequency range	100 kHz to 1 GHz	100 kHz to 1 GHz
Straight line within 5 %	100 kHz to 6 MHz	100 kHz to 6 MHz
Maximum deviation	3 dB	3.5 dB
Voltage ranges	150 mV to 15 V	15 V to 200 V
Max. voltage a.c.	30 V	200 V
Max. voltage d.c.	200 V	500 V
Input capacitance	2 pF	2 pF
T-piece (included in PM 9212)		
Impedance	50 Ω	
Standing wave ratio	1,25 at 700 MHz 1,15 at 1 GHz with 100:1 attenuator	

Probe type PM 9210, in combination with the probe accessories (adjustable earthing pin and Dage adaptor), is suitable for measurements up to a frequency of 100 MHz.

For measurements beyond this frequency it is advisable to use the 50 Ω T-piece and the 50 Ω terminating resistance which are included in the PM 9212 probe accessories set.

3.2.2.6. *Dimensions of 19 inch rack mounting set (Fig. 9 page 130)*

4. PRINCIPLE OF OPERATION

The PM 2521 is a digital multimeter by which it is also possible to measure: time, frequency and dB.

As control-unit in the PM 2521 the 8035 microcomputer is used. The PM 2521 can be subdivided into three main part. viz; Analog section, Control section and Display section.

Figure 10 page 134 shows the parts by which the sections are built-up.

A more detailed blockdiagram is given in Fig. 11 page 134, which shows the basic principles of signal measurements.

4.1. ANALOG SECTION

4.1.1. Measuring voltages, currents, resistances and diodes

In the analog section, the voltages ($V_{\text{---}}$, V_{\sim}), currents ($A_{\text{---}}$, A_{\sim}), resistances (Ω) or diodes ($\rightarrow|+$) input signals are converted into a voltage that is suitable for the analog-to-digital convertor (ADC).

The analog voltage is supplied to the ADC and measured.

4.1.2. Measuring time and frequency

Time (s) and frequency (Hz) input signals are first attenuated by the voltage attenuator and then supplied to a comparator. The switching level of the comparator can be influenced with the TRIGGER LEVEL potentiometer at the front of the PM 2521. Influencing the comparator input level makes selective measuring of pulses possible. From the comparator the time signals are directly supplied to the microcomputer, where the time is software counted. The frequency signals are supplied to a counter.

4.1.3. Measuring temperatures

Temperature measurements are made with the optional Pt-100 probe PM 9249. The Pt-100 probe is connected to a Thomson bridge, to which the current source is connected. The voltage from the Thomson bridge (4-wire resistance measurements) is directly supplied to the ADC and measured.

4.1.4. Decibel measurements

In function dB the measured a.c. voltage is software converted into a dB value. The dB function is combined with the V_{\sim} function.

4.1.5. Measurements in relative reference mode

In the relative reference mode the measured value is captured by the microcomputer. Each subsequent positive or negative deviation from the relative reference level will be displayed. The relative reference mode is only valid in the functions $V_{\text{---}}$, dB, Ω , $\rightarrow|+$ and $^{\circ}\text{C}$.

4.1.6. Control of the analog section

The analog section is controlled by the microcomputer. The setting of the directions for the measuring functions is determined by the function selector.

The setting of the ranges, in one function is determined by the ranging switches AUTO/MAN*, UP and DOWN. The range information switches the attenuation of the input signal, the sensitivity of the RMS convertor and the sensitivity of the current source. The function and range information is supplied to the analog section via reed relay control.

4.1.7. ADC

The analog-to-digital conversion used in the PM 2521 is in accordance with the Delta modulation principle.

The ADC system has been built into two LSI circuits. The analog signal is converted into a data signal. The data cycle of the data signal is proportional to the height of the analog input signal of the ADC.

The ADC system is also equipped with an automatic zero point correction.

4.2. CONTROL SECTION

The heart of the control section of the PM 2521 is a 8035 microcomputer.

A 4k ROM is used as program memory. In the control section the data acquisition takes place.

Inputs for the control section are : the mode switches
the function selector
the counter output
the ROM

Outputs for the control section are : the display
the relay control

In general the following actions are made by the microcomputer /ROM.

INPUT/OUTPUT	ACTIONS
MODE SWITCHES Range commands STOP/RESET commands +/- commands dB (V~) command ZERO SET command	In autoranging mode: Check if the counter output is higher or lower than a certain value. If so, select a higher or lower range. Display of the decimal point. In manual ranging mode: Select a higher or lower range on up or down commands of the UP or DOWN pushbuttons. Display of the decimal point. Stop the time measurement. Reset the time measurement. Set the + or – trigger level. Set the dB function and convert the ac voltage into a dB value. Set the relative reference value and display each subsequent positive or negative deviation of the relative reference value.
FUNCTION SELECTOR	Set the direction of the input signal in the analog section. Display the function indication.
THE COUNTER OUTPUT	Display the counted data including the polarity. If the counter output exceeds the end of range value, display OL.
THE DISPLAY	Display the counter data, the decimal point and the function indication.
THE RELAY CONTROL	Supply the range and function information to the analog section, where the attenuation factors, the sensitivity of the ADC and RMS convertor, and the direction of the input signal are set.

4.3. DISPLAY SECTION

The display section consists of a liquid crystal display interface and the liquid crystal display (LCD).

The display section is directly controlled by the microcomputer. The data from the microcomputer is supplied to the LCD interface in serial form.

5. INSTALLATION

5.1. MAINS SUPPLY

5.1.1. Safety instruction

Before inserting the mains plug into a mains socket, ensure that the instrument is set for the correct local mains voltage.

WARNING: The opening of covers or removal of parts, except those to which access can be gained by hand is likely to expose live parts, and accessible terminals may also be live.

The instrument shall be disconnected from all voltage sources before any replacement or maintenance and repair during which the instrument will be opened.

If afterwards, any adjustment, maintenance or repair of the opened instrument under voltage conditions is inevitable, it shall be carried out only by a skilled person who is aware of the hazard involved.

Bear in mind that capacitors inside the instrument may still be charged even if the instrument is separated from all voltage sources.

5.1.2. Replacing the main fuse

The mains fuse is situated in the mains socket at the rear of the instrument. (Fig. 23, page 142). Also the spare fuse for the set mains voltage is situated in the combined mains-socket/fuse-holder.

Mains voltage	Required fuse
110V - 220V - 240V	125mA (fast blow)

Make sure that only fuses with the required rated current and of the specified type are used. (IEC127-I and F0,125c DIN 41571).

The use of make shift fuses and the short-circuiting of fuse holders are prohibited.

5.1.3. Adaption to the mains voltage

The PM2521 is delivered from the factory in the 220V 50Hz ... 60Hz version. Adaption to 110V, 240V is possible by altering the wiring on the mains transformer.

For adaption proceed as follows:

- Remove the top cover (Fig. 12 page 138) as follows:
 - Place the handle in its bottom position.
 - Remove the two fixing screws which attach the top cover to the bottom cover (Fig. 23, page 142).
 - Lever the top cover and pull it backwards.

The mains transformer is located in the top cover. It is plugged into the motherboard.

- Alter the wiring on the mains transformer as shown in Fig. 13, page 138.

It is not necessary to replace the mains fuse when the PM2521 is adapted to another mains voltage. Only in case of a defective mains fuse it should be replaced.

5.1.4. Adaption to the mains frequency

The PM2521 can be used with a mains frequency from 47Hz up to 63Hz without modification.

6. OPERATION

6.1. SWITCHING ON

The instrument is ready for use after connection to the mains and earthing. It is switched on by depressing pushbutton-switch POWER.

Remarks:

After switching on the display will show –CAL– for about ten seconds. In this period the PM 2521 carries out an internal calibration procedure.

After the calibration procedure the PM 2521 jumps to the function that is selected by the function selector.

When the PM 2521 is brought from a cold into a warm environment, condensation can cause incorrect readings.

6.2. CONTROLS

6.2.1. Front panel (Fig. 22 page 142).

DESCRIPTION	APPLICATION
POWER	POWER ON/OFF pushbutton switch
AUTO/MAN* STOP RESET	Multifunction pushbutton
AUTO/MAN*	<p>Pushbutton for selection between automatic or manual ranging mode, with exception of function s. Manual ranging mode is indicated with a * on the righthand side of the display. The manual ranging mode functions in conjunction with the UP and DOWN pushbutton. In automatic ranging mode, in a 4½ digit function, the UP ranging level is at a display of 20200 and the DOWN ranging level at a display of 01800. For 3½ digit function these figures respectively are 2020 and 0180.</p> <p>To eliminate the hysteresis in the automatic ranging mode, a higher or lower range can be selected with pushbuttons UP or DOWN.</p> <p>UP between display 18000 and 20200 (1800 – 2020) DOWN between display 01800 and 02020 (0180 – 0202)</p>
STOP RESET	<p>STOP and RESET pushbutton in the timer function (s). If the STOP/RESET pushbutton is depressed when the PM 2521 is measuring, than the measurement is stopped. If the STOP/RESET pushbutton is depressed when a measurement is completed, than the PM 2521 is reset, and a new measurement can start.</p>

DESCRIPTION		APPLICATION							
UP		Manual UP-ranging pushbutton 1x depress = 1 range up							
DOWN		Manual DOWN-ranging pushbutton 1x depress = 1 range down							
Function	V $\overline{\text{---}}$ V \sim	Hz	Trigger level	s	°C	\blacktriangleright	Ω	mA $\overline{\text{---}}$ mA \sim	A $\overline{\text{---}}$ A \sim
Range	200 mV 2 V 20 V 200 V 2000 V	10 kHz 100 kHz 1 MHz 10 MHz	2 V 20 V 200 V 2000 V	10 ¹ 10 ² 10 ³ 10 ⁴ 10 ⁵	-60/ +200	2 · V	200 Ω 2 k Ω 20 k Ω 200 k Ω 2 M Ω 20 M Ω	2 μ A 20 μ A 200 μ A 2 mA 20 mA	200 mA 2 A 20 A
Display	4½	5	3½	5	4½	4½	4½	3½	
+/- dB (V \sim) ZEROSET		Multifunction pushbutton							
+/-		+/- trigger level selection pushbutton In function trigger level a selection can be made between the + or - trigger level. The selected trigger level can be adjusted from zero to end of range with the thumbwheel.							
dB (V \sim) ZERO SET		Decibel (dBV \sim) mode and relative reference pushbutton. In function V \sim the measured value will be displayed in dB, when the pushbutton is depressed once. When the pushbutton is depressed for the second time, the PM 2521 jumps to the relative reference mode. The display will jump to zero dB. Each subsequent reading will indicate the positive or negative deviation from the relative reference value. When the pushbutton is depressed for the third time, the PM 2521 jumps to the V \sim function again.							
ZERO SET		Relative reference pushbutton, for functions V $\overline{\text{---}}$, dB, Ω , \blacktriangleright and °C. When the pushbutton is depressed the PM 2521 jumps to the relative reference mode. The display will jump to zero. Each subsequent reading will indicate the positive, or negative deviation from the relative reference value. To leave the relative reference mode depress pushbutton ZERO SET again.							

DESCRIPTION	APPLICATION
FUNCTION SELECTOR	Rotary function selector. For function °C an optional Pt-100 temperature probe e.g. PM 9249 must be used. Function trigger level is combined with pushbutton +/- and the thumbwheel. Function s is combined with the STOP/RESET pushbutton and with function trigger level. Function Hz is combined with function trigger level.
INPUT SOCKETS <i>0</i> <i>V-Ω-mA</i> <i>0.2 A – 10 A</i> <i>PROBE</i>	Combined LO socket for all functions with exception of °C. Combined Hi socket for the function V $\overline{\text{---}}$, V \sim , Hz, trigger level, s, mA $\overline{\text{---}}$, mA \sim , Ω, \rightarrow Hi input socket for high currents 8-pole DIN socket to be used for: – Pt 100 temperature probe e.g. PM 9249 – Data Hold probe PM 9263
POTENTIOMETERS +/- thumbwheel 	Potentiometer for adjusting the + and – trigger level. Zero setting potentiometer.

6.2.2. Rear panel (Fig. 23, page 142).

DESCRIPTION	APPLICATION
MAINS INPUT SOCKET	Input socket for 110 V, 220 V and 240 V 50/60 Hz mains
FUSE	Mains fuse, situated in a special fuse holder in the mains socket 125 mA Fast, 110 V ... 240 V mains

6.3. ZERO SETTING

Proceed as follows:

- Select function V $\overline{\text{---}}$ with the function selector.
- Select the automatic ranging mode with pushbutton AUTO/MAN*.

Remark:

Manual ranging mode is indicated with a * on the display.

- Short circuit the 0 and V-Ω-mA terminal.
- Adjust with a screwdriver and the zero potentiometer, which is situated between the PROBE input and the +/- pushbutton, the display to 000.00 mV ± 1 digit.

6.4. MEASURING

WARNING: It must be borne in mind that in all measurements the zero ∇ of the PROBE-input is raised to the same potential as that of the 0-input socket.
Do not touch the zero ∇ of the PROBE-input during a measurement.

6.4.1. Standard measurements

6.4.1.1. Direct voltage measurements ($V_{\text{---}}$)

GENERAL

Direct voltages can be measured in two ways viz.:

- Direct voltage measurements (standard method),
- Direct voltage measurements in relative reference mode. The relative reference mode offers the possibility to select a predetermined relative zero reference level. Each subsequent reading will indicate the positive or negative deviation from the relative reference value.

Example:

Measured voltage e.g.: +1.0000 V in the relative reference mode +1.0000 V will be displayed as +0.0000 V.

The subsequent measured voltages are e.g. +1.1000 V and +0.9000 V.

The values displayed will be respectively +0.1000 V and –0.1000 V

DIRECT VOLTAGE MEASUREMENTS (STANDARD METHOD)

- Select function $V_{\text{---}}$ with the function selector.
- Select the manual or automatic ranging mode with pushbutton AUTO/MAN*.

Remarks:

Manual ranging is indicated with a * on the display.

In automatic ranging mode the UP level is 20200 and the DOWN level is 01800.

- Select in manual ranging mode the correct range with pushbuttons UP or DOWN.

Remark:

Available ranges are: 200.00 mV
2.0000 V
20.000 V
200.00 V
2000.0 V

Overload is indicated with OL on the display (Display > 21000).

In range 2000 V overload is also indicated at 2100.0 V. However, the maximum input voltage is 1000 $V_{\text{---}}$, 1400 V peak.

- Connect the voltage source to the 0 and V terminal.

Remark:

The polarity indicated is the polarity of the V terminal with respect to the 0 terminal.

Voltages from 1 kV upto 30 kV can be measured with the HT probe PM 9246.

Refer to chapter 6.4.2.1.

DIRECT VOLTAGE MEASUREMENTS IN RELATIVE REFERENCE MODE (ZERO SET)

- Measure the direct voltage as described above.
- Depress pushbutton ZERO SET.

Remark:

The display will be held for one second and a Z will appear on the right-hand side of the display. The value which is on the display during this one second is the relative reference value. After this one second the display jumps to zero and the indication ZS (ZERO SET) will appear on the display. The PM 2521 has now been switched to the relative reference (ZERO SET) mode. In the relative reference mode the PM 2521 switches to manual ranging*. Each subsequent reading will indicate the positive or negative deviation from the relative reference value.

- To leave the relative reference mode, depress pushbutton ZERO SET again.

Remark:

Overload is indicated with OL on the display (Input signal > 21000).
 In range 2000 V overload is also indicated at 2100.0 V.
 However, the maximum input voltage is 1000 V $\overline{\text{---}}$, 1400 V peak.
 The maximum reading on the display is 40000.

6.4.1.2. Alternating voltage measurements ($V_{\sim rms}$)

GENERAL

The PM 2521 measures the RMS value of the AC input signal. As the AC function of the PM 2521 is AC coupled a DC component in the AC input signal is blocked. The DC component is not included in the measuring result.

ALTERNATING VOLTAGE MEASUREMENTS

- Select function $V_{\sim rms}$ with the function selector.
- Select the manual or automatic ranging mode with pushbutton AUTO/MAN*.

Remark:

Manual ranging is indicated with a * on the display. In automatic ranging mode the UP level is 20200 and the DOWN level is 01800.

- Select in manual ranging mode the correct range with pushbutton UP or DOWN.

Remark:

Available ranges are: 200.00 mV
 2.0000 V
 20.000 V
 200.00 V
 2000.0 V

Overload is indicated with OL on the display (Display > 21000). In range 2000 V overload is also indicated at 21000 V. However, the maximum input voltage is 600 V rms.
 If the display is < 0.5 % of end of range (100 digits) the display will indicate zero.

- Connect the voltage source to the 0 and V terminal.

6.4.1.3. Decibel measurements (dBV~)

GENERAL

The dB function offers the possibility to measure the ratio between ac voltages, and to express this in decibels (dB). Decibel measurements can be made in two ways viz.:

- dB measurements (Standard method),
- dB measurements in relative reference mode.

The relative reference mode enables selection of a predetermined relative reference zero level. Each subsequent reading will indicate the positive or negative deviation from the relevant reference value.

Example:

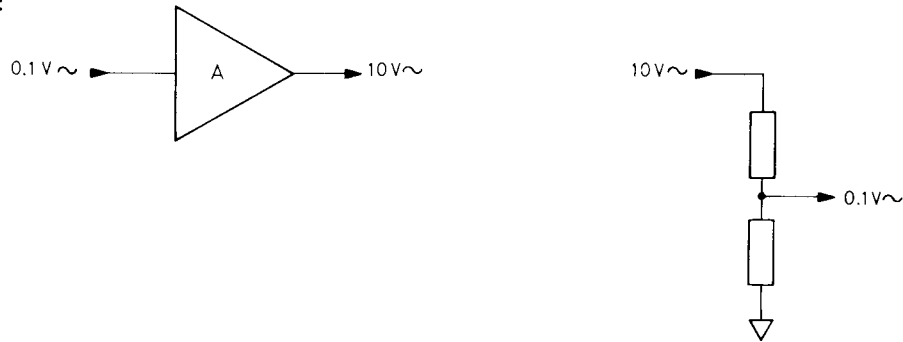

ST 3014

Fig. 14. dB measurements

FUNCTION	AMPLIFIER	
	IN	OUT
V~	100.00 mV	10.000 V
dB	-17.7 dB	+22.2 dB
dB ZERO SET	00.0 dB	+39.9 dB

ATTENUATOR	
IN	OUT
10.000 V	100.00 mV
+22.2 dB	-17.7 dB
00.0 dB	-39.9 dB

dB MEASUREMENTS (STANDARD METHOD)

- Select function V~ with the function selector.
- Select the automatic ranging mode with pushbutton AUTO/MAN*.

Remark:

Manual ranging is indicated with a * on the display. In automatic ranging mode the UP level is 20200 and the DOWN level is 01800.

- Connect the voltage source to the 0 and V terminal and measure the voltage.

Remark:

Take care that the maximum input voltage of 600 V rms is not exceeded.
600 V rms = +57,8 dB.

- Depress pushbutton dB (V~) once.

Remark:

The measured ac voltage is now expressed in decibels (dB).
0 dB = 1 mW, 600 Ω 0,775 V is used as reference

- To leave the dB function and to jump to the V~function again, depress pushbutton dB (V~) twice.

dB MEASUREMENTS IN RELATIVE REFERENCE MODE (ZERO SET)

- Measure the alternating voltage in the dB function as described above.
- Depress pushbutton dB (V~), ZERO SET again.

Remark:

The display will be held for one second and a Z will appear on the right-hand side of the display. The value which is on the display during this one second is the relative reference value. After this one second the display jumps to zero and the indication ZS (ZERO SET) will appear on the display. The PM 2521 has now been switched to the relative reference (ZERO SET) mode. In the relative reference mode the PM 2521 switches to automatic ranging. Each subsequent reading will indicate the positive or negative deviation from the relative reference value.

- To leave of the dB function, depress pushbutton dB (V~) ZERO SET again.

Remark:

Take care that the maximum input voltage of 600 V rms is not exceeded. 600 V rms = +57.8 dB. However, in relative reference mode the relative reference value must be added with the measured value.

6.4.1.4. Direct current measurements (A $\overline{\text{---}}$)

- Select function A $\overline{\text{---}}$ with the function selector.
- Select the manual or automatic ranging mode with pushbutton AUTO/MAN*.

Remark:

Manual ranging is indicated with a * on the display.

In automatic ranging mode the up level is 2020 and the down level is 0180.

- Select in manual ranging mode the correct range with pushbutton UP or DOWN.

Remark:

Available ranges are:	mA terminal	0.2 A – 10 terminal
	2.000 μ A	200.0 mA
	20.00 μ A	2.000 A
	200.0 μ A	20.00 A
	2.000 mA	
	20.00 mA	

Overload is indicated with OL on the display (Display > 2100).

In range 20 A overload is also indicated at 21.00 A. However, the maximum continuous input current is 10 A.

- Connect the current source to the 0 and mA or 0.2 A – 20 A terminal

Remark:

The polarity indicated is the polarity of the A terminals with respect to the 0 terminal.

Current up to 31.6 A can be measured with shunt PM 9244. Refer to chapter 6.4.2.2.

Due to the measuring method the display does not indicate zero when the input is short circuited.

6.4.1.5. Alternating current measurements ($A\sim rms$)

GENERAL

The PM 2521 measures the RMS value of the AC input signal. As the AC function of the PM 2521 is AC coupled, a DC component in the AC signal is blocked. The DC component is not included in the measuring result.

ALTERNATING CURRENT MEASUREMENTS

- Select function $A\sim rms$ with the function selector.
- Select the manual or automatic ranging mode with pushbutton AUTO/MAN*.

Remark:

Manual ranging is indicated with a * on the display. In automatic ranging mode the UP level is 2020 and the DOWN level is 0180.

- Select in manual ranging mode the correct range with pushbuttons UP or DOWN.

Remark:

Available ranges are:	mA terminal	0.2 A –20 A terminal
	2.000 μA	200.0 mA
	20.00 μA	2.000 A
	200.0 μA	20.00 A
	2.000 mA	
	20.00 mA	

Overload is indicated with OL on the display (Display > 2100).

In range 20 A overload is also indicated at 21.00 A. However, the maximum continuous input current is 10 A. If the display is > 0.5 % of end or range (10 digits), the display will indicate zero.

- Connect the current source to the 0 and mA or 0.2 A –20 A terminal.

Remark:

Currents up to 100 A can be measured with current transformer PM 9245. Refer to chapter 6.4.2.2. Due to the measuring method, the display does not indicate zero when the input is short circuited.

6.4.1.6. Resistance measurements (Ω)

GENERAL

Resistances can be measured in two ways viz.:

- Resistances measurements (Standard method).
- Resistance measurements in relative reference mode.
The relative reference mode offers the possibility to select a predetermined relative zero reference level.
Each subsequent reading will indicate the positive or negative deviation from the relative reference value.

Example:

Measured resistance value is e.g. 1.2000 k Ω . In relative reference mode 1.2000 k Ω will be displayed as 0.0000 k Ω . The subsequent measured resistance value are e.g. 1.2500 k Ω and 1.1500 k Ω . The value displayed will be respectively +0.0500 k Ω and –0.0500 k Ω .

RESISTANCE MEASUREMENTS (STANDARD METHOD)

- Select function Ω with the function selector.
- Select the manual or automatic ranging mode with pushbutton AUTO/MAN*.

Remark:

Manual ranging is indicated with a * on the display. In automatic ranging mode the UP level is 20200 and the DOWN level is 01800.

- Select in manual ranging mode the correct range with pushbuttons UP or DOWN.

Remark:

Available ranges are:

200.00	Ω
2.0000	k Ω
20.000	k Ω
200.00	k Ω
2.0000	M Ω
20.000	M Ω

Overload is indicated with OL on the display (Display > 21000).

- Connect the unknown resistance to the 0 and Ω terminal.

Protection:

The input is protected up to 265 V rms.

RESISTANCE MEASUREMENTS IN RELATIVE REFERENCE MODE (ZERO SET)

- Measure the resistance value as described above.
- Depress pushbutton ZERO SET.

Remark:

The display will be held for one second and a Z will appear on the right-hand side of the display. The value which is on the display during this one second is the relative reference value. After this one second the display jumps to zero and the indication ZS will appear on the display. The PM 2521 has now been switched to the relative reference (ZERO SET) mode. Each subsequent reading will indicate the positive or negative deviation from the relative reference value. The maximum reading is 40000.

In the relative reference mode the PM 2521 switches to manual ranging*.

- To leave the relative reference mode, depress pushbutton ZERO SET again.

6.4.1.7. Diode measurements ($\rightarrow|+$)

GENERAL

Diodes can be measured in two ways viz.:

- Diode measurements (Standard method).
- Diode measurements in relative reference mode.

The relative reference mode offers the possibility to select a predetermined relative reference zero level.

Each subsequent reading will indicate the positive or negative deviation from the relative reference value.

Example:

Measured diode value is e.g. 0.6200 V.

In relative reference mode 0.6200 V will be displayed as 0.0000 V. The subsequent measured diode values are e.g. 0.6225 V and 0.6175 V. The values displayed will be respectively +0.0025 V and –0.0025 V. In this way it is possible to compare diode junctions.

DIODE MEASUREMENTS (STANDARD METHOD)

- Select function diode $\rightarrow|+$ with the function selector.

Remark:

The diode function has only one range.

The value displayed is the voltage in forward or reverse direction across the diode in the 2 V range.

- Connect the diode to the 0 and V- Ω -mA terminal according the table below.

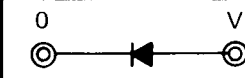
	Reading	
	Forward	Reverse
Si	0.6000 - 0.9000 V	OL
Ge	0.1000 - 0.3000 V	OL
		

DIODE MEASUREMENTS IN RELATIVE REFERENCE MODE (ZERO SET)

- Measure the diode as described above.
- Depress pushbutton ZERO SET.

Remark:

The display will be held for one second and a Z will appear on the right-hand side of the display. The value which is on the display during this one second is the relative reference value. After this one second the display jumps to zero and the indication ZS will appear on the display. The PM 2521 has now been switched to the relative reference mode (ZERO SET). In the relative reference mode the PM 2521 switches to manual ranging*. Each subsequent reading will indicate the positive or negative deviation from the relative reference value.

- To leave the relative reference mode, depress pushbutton ZERO SET again.

6.4.1.8. Temperature measurements ($^{\circ}\text{C}$)

GENERAL

For temperature measurements the optional Pt-100 temperature probe PM 9249 is needed. Temperature can be measured in two ways viz.:

- Temperature measurements (Standard method).
- Temperature measurements in relative reference mode.

The relative reference mode offers the possibility to select a predetermined relative reference zero level.

Each subsequent reading will indicate the positive or negative deviation from the relative reference value.

Example:

Measured temperature is e.g. $+0022.0^{\circ}\text{C}$.

In relative reference mode $+0022.0^{\circ}\text{C}$ will be displayed as $+0000.0^{\circ}\text{C}$.

The subsequent measured temperatures are e.g. $+24^{\circ}\text{C}$ and $+21^{\circ}\text{C}$. The values displayed will be respectively $+0002.0^{\circ}\text{C}$ and -0001.0°C .

TEMPERATURE MEASUREMENTS (STANDARD METHOD)

- Select function $^{\circ}\text{C}$ with the function selector.

Remark:

The temperature function has only one range.

- Connect the temperature probe to the PROBE input of the PM 2521. (Refer to Fig. 15).

Remark:

The measuring range of the PM 9249 is -60°C to $+200^{\circ}\text{C}$.

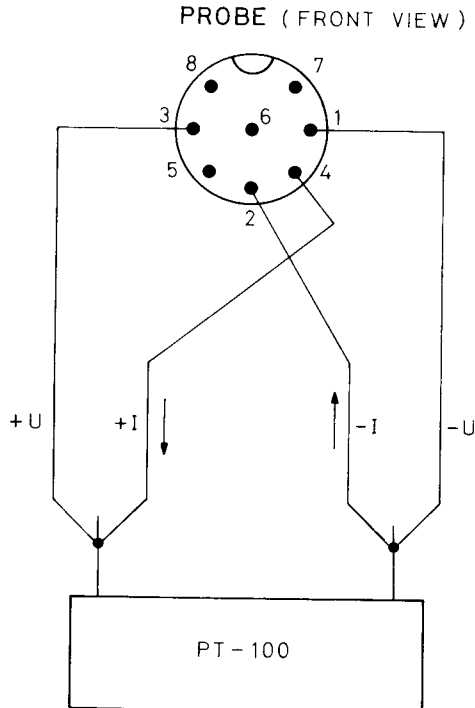

ST 3164

Fig. 15. Temperature probe connection.

TEMPERATURE MEASUREMENTS IN RELATIVE REFERENCE MODE (ZERO SET)

- Measure the temperature as described above.
- Depress pushbutton ZERO SET.

Remark:

The display will be held for one second and a Z will appear on the right hand side of the display.

The value which is on the display during this one second is the relative reference value.

After this one second the display jumps to zero and the indication ZS will appear on the display. The PM 2521 has now been switched to the relative reference mode (ZERO SET). In the relative reference mode the PM 2521 switches to manual ranging*. Each subsequent reading will indicate the positive or negative deviation from the relative reference value.

- To leave the relative reference mode depress pushbutton ZERO set again.

6.4.1.9. Frequency measurements (Hz)

GENERAL

The frequency measurements in the PM 2521 are made in conjunction with the trigger level function. Each time the input signal exceeds the trigger level a count is made. As the trigger can be adjusted, it is important to know where the trigger level is and if triggering takes place before frequency measurements are made.

The order for measuring the frequency of a signal is as follows:

- Selection of the sensitivity range.
- Selection of the trigger level
- Measurement of the frequency

FREQUENCY MEASUREMENTS

Selection of the sensitivity range

- Select function $V_{\text{---}}$ with the function selector.
- Select the automatic ranging mode by depressing the AUTO/MAN* pushbutton.

Remark:

Manual ranging is indicated with * on the display.

- Connect the voltage source to the 0 and V terminal and measure the input signal.
- Make a note of the selected range and polarity. Slow signals may pass more than one range.
- Select function trigger level with the function selector and select one of the noted ranges and polarity.

Remark:

Ranges	
$V_{\text{---}}$	Trigger level
200 mV 2 V	2 V
20 V 200 V 2000 V	20 V 200 V 2000 V

Input signals that are lower than 7,5 % of the end of range value of the trigger level range cannot be triggered accurately.

In the trigger level function only manual ranging is possible with the pushbuttons UP or DOWN.

Selection of the trigger level

- Select the + or – trigger level by depressing pushbutton +/-.

Remark:

Signals which are higher or lower than the circuit zero of the PM 2521 (0 terminal) can be triggered with respectively the + or – trigger level. In + trigger level mode the PM 2521 triggers on positive crossings of the trigger level. In – trigger level mode the PM 2521 triggers on negative crossings of the trigger level.

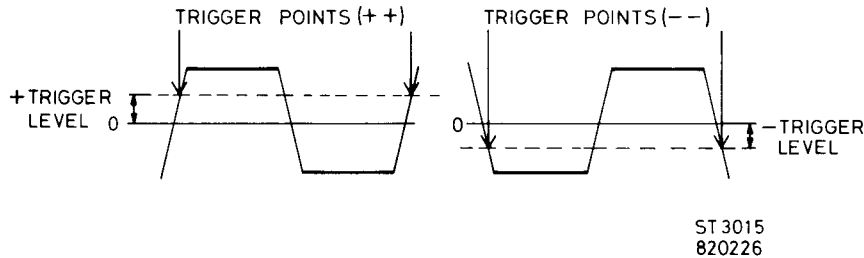

Fig. 16. Trigger level selection in function Hz.

- Adjust the trigger level with the thumbwheel until the GATE indication on the display is ignited.

Remark:

The trigger level can be adjusted between zero and end of range.

The voltage reading on the display indicates the height of the trigger level.

If the input signal cannot be triggered, proceed as follows:

- Select another trigger level polarity by depressing pushbutton +/- and try to trigger again.
- Check whether the input signal is lower than 7,5 % of the end of range value of the selected trigger level range. Signals lower than 7,5 % cannot be triggered accurately.
- Select a higher trigger level range by depressing pushbutton UP and try to trigger again.

Measurement of the frequency

- Select function Hz with the function selector.
The PM 2521 will now display the frequency of the input signal.

Remark:

The PM 2521 is switched to automatic ranging mode.

The available ranges in the Hz function are

RANGE	RANGING MODES	GATE TIME
10 kHz	MANUAL* only	10 s
100 kHz	AUTO or	1 s
1 MHz	MANUAL *	100 ms
10 MHz		10 ms

Manual ranging mode can be selected by depressing pushbutton AUTO/MAN*.

By depressing either pushbutton UP or DOWN the ranges are selected.

If the measured value exceeds, the range end value (> 99999), overload (OL) will be displayed.

During measuring the GATE indication is ignited. This only means that the gate is open. It does not mean that the PM 2521 triggers.

- If the display shows an unstable or a zero reading, check the sensitivity and the trigger level again.

6.4.1.10. Time measurements (s)

GENERAL

The time measurements in the PM 2521 are made in conjunction with the trigger level function. Each time the input signal exceeds the trigger level the PM 2521 is triggered. As the trigger level can be adjusted it is important to know where the trigger level is and if triggering takes place before time measurements are made.

The order for time measurement is as follows:

- Selection of the sensitivity ranges
- Selection of the trigger level
- Time measurements

The time measurements function has two trigger modes viz.:

- Normal trigger mode

Signals which are higher or lower than the circuit zero of the PM 2521 (0 terminal) can be triggered with the + or – trigger level respectively. In + trigger level mode the PM 2521 triggers on positive crossings of the trigger level. In – trigger level mode the PM 2521 triggers on negative crossings of the trigger level.

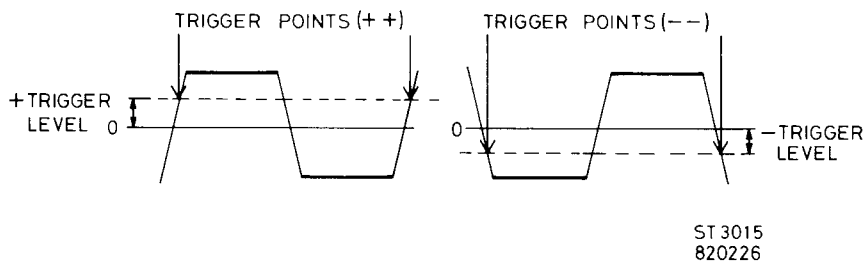

Fig. 17. Normal mode trigger level selection in function s.

- Special trigger mode with DATA HOLD PROBE PM 9263 (Start and stop on inversed slopes).

In data hold mode of the PM 9263 the PM 2521 triggers in + trigger level mode at a positive and negative crossing of the trigger level. In – trigger level mode the PM 2521 triggers at a negative and a positive crossing of the trigger level.

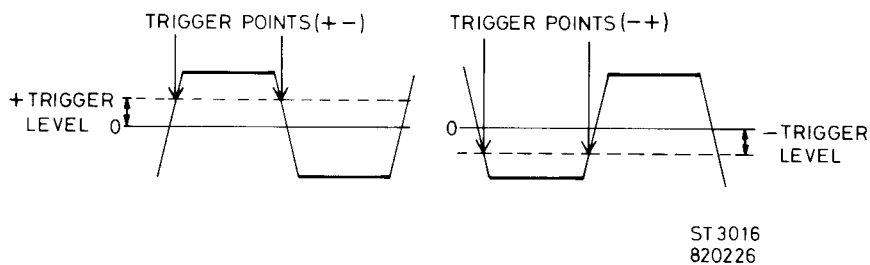

Fig. 18. Special mode trigger level selection in function s.

Remark:

The minimum width of a signal to measure time is 10 ms.

TIME MEASUREMENTS

Selection of the sensitivity ranges

- Select function $V_{\text{-----}}$ with the function selector.
- Select the automatic ranging mode by depressing the AUTO/MAN* pushbutton.

Remark:

Manual ranging is indicated with * on the display.

- Connect the voltage source to the 0 and V terminal and measure the input signal.
- Make a note of the selected range and polarity. Slow signals may pass more than one range.
- Select function trigger level with the function selector and select one of the noted ranges and polarity.

Remark:

Ranges	
$V_{\text{-----}}$	Trigger level
200 mV 2 V	2 V
20 V 200 V 2000 V	20 V 200 V 2000 V

Input signals that are lower than 7.5 % of the end of range value of the trigger level range cannot be triggered accurately.

In the trigger level function only manual ranging is possible, with the pushbuttons UP or DOWN.

Selection of the trigger level

NORMAL TRIGGER MODE

- Select the + or – trigger level by depressing pushbutton +/-.

Remark:

Signals which are higher or lower than circuit zero of the PM 2521 (0-terminal) can be triggered with the + or – trigger level respectively. In + trigger level mode, the PM 2521 triggers on positive crossings of the trigger level. In – trigger level mode the PM 2521 triggers on negative crossings of the trigger level.

- Adjust the trigger level with the thumbwheel until the GATE indication on the display is ignited.

Remark:

The trigger level can be adjusted between zero and end of range.

The voltage reading on the display indicates the height of the trigger level.

If the input signal cannot be triggered, proceed as follows:

- Select another trigger level polarity by depressing pushbutton +/- and try to trigger again.
- Check whether the input signal is lower than 7.5 % of the end of range value of the selected trigger level range. Signals lower than 7.5 % cannot be triggered accurately.
- Select a higher trigger level range by depressing pushbutton UP and try to trigger again.

SPECIAL TRIGGER MODE WITH DATA HOLD PROBE PM 9263 (Refer to Fig. 27, page 150).

- Connect the PM 9263 with the DIN plug and the banana-plug connector ($V\Omega-0$) to the corresponding terminals of the PM 2521.
- Connect a zero lead to the probe. This can be done:
 1. With separate banana lead connected to the 0 socket of the probe.
 2. With the zero cable which is supplied with the PM 9263.
- Select the most suitable test pin for the probe.
- Push the slide switch (white ring) in position RUNNING, away from the probe tip.
- Measure the input signal as described under heading "Selection of the sensitivity ranges".
- Select the correct trigger level as described under heading "Selection of the trigger level" in "NORMAL TRIGGER MODE".
- Select functions with the function selector first.
- Push the slide switch on the probe to position HOLD, towards the probe tip (Refer to Fig. 19).

Remark:

The PM 2521 triggers in + trigger level mode at a positive (start) and negative (stop) crossing of the trigger level. In – trigger level mode the PM 2521 triggers at a negative (start) and a positive (stop) crossing of the trigger level.

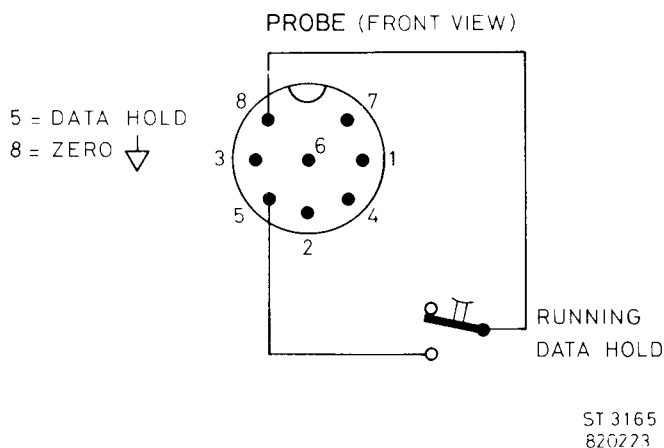

Fig. 19. Data Hold connection

Time measurements

- Select functions with the function selector.

Remark:

The PM 2521 will display the time between two crossings of the trigger level, (++) or (– –). In special trigger mode the trigger points are (+ –) or (– +). The time measurement is started at the first crossing and stopped after the second crossing. When the measuring of the time is stopped the measured value will be displayed. The available ranges in the time functions are: 10^1s , 10^2s , 10^3s , 10^4s , 10^5s .

The ranges are selected automatically.

When a time measurement is started the PM 2521 automatically selects the 10^1s range.

- To start a new measurement proceed as follows.
Reset the PM 2521 by depressing pushbutton STOP/RESET.

Remark:

The display will jump to zero and the PM 2521 will start a new measurement after a crossing of the trigger level.

- To stop a measurement proceed as follows.
Depress pushbutton STOP/RESET while the PM 2521 is measuring.

Remark:

The time measured will be displayed.

To start a measurement, depress pushbutton STOP/RESET again.

6.4.1.11. Peak voltage measurement

GENERAL

The adjustable trigger level with the trigger (GATE) indication offers the possibility to measure peak voltages. Measuring peak voltages is done in the trigger level function. This means that the peak voltages are measured with the accuracy of the trigger level function.

The order for measuring the peak voltage of a signal is as follows:

- Selection of the sensitivity range
- Selection of the trigger level
- Measurement of the peak voltage

PEAK VOLTAGE MEASUREMENTS

Selection of the sensitivity ranges

- Select function $V_{\text{---}}$ with the function selector.
- Select the automatic ranging mode by depressing the AUTO/MAN*

Remark:

Manual ranging is indicated with * on the display.

- Connect the voltage source to the 0 and V terminal and measure the input signal.
- Make a note of the selected range and polarity. Slow signals may pass more than one range.
- Select function trigger level with the function selector, and select one of the noted ranges and polarity.

Remark:

Function trigger level has four ranges.

Ranges	
$V_{\text{---}}$	Trigger level
200 mV 2 V	2 V
20 V 200 V 2000 V	20 V 200 V 2000 V

Input signals that are lower than 7.5 % of the end of range value of the trigger level range cannot be triggered accurately.

In the trigger level function only manual ranging is possible with pushbuttons UP or DOWN.

Selection of the trigger level

- Select the + or – trigger level by depressing pushbutton +/-.

Remark:

Signals which are higher or lower than the circuit zero of the PM 2521 (0 terminal) can be triggered with the + or – trigger level respectively.

In + trigger level mode the PM 2521 triggers on positive crossings of the trigger level. In – trigger level mode the PM 2521 triggers on negative crossings of the trigger level.

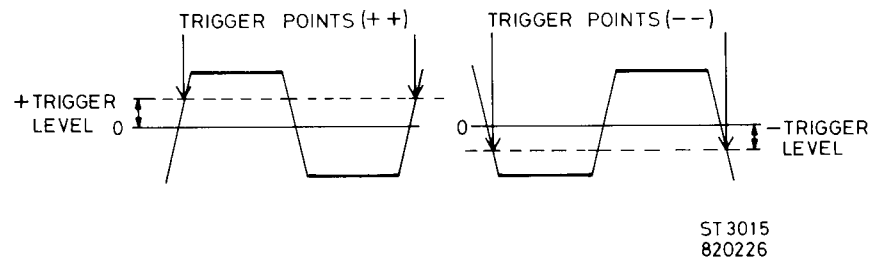

Fig. 20. Trigger level selection in peak voltage measurement mode.

- Adjust the trigger level with the thumbwheel until the GATE indication on the display is ignited.

Remark:

The trigger level can be adjusted between zero and end of range.

The voltage reading on the display indicates the height of the trigger level.

If the input signal cannot be triggered, proceed as follows:

- Select another trigger level polarity depressing pushbutton +/- and try to trigger again.
- Check whether the input signal is lower than 7.5 % of the end of range value of the selected trigger level range. Signals lower than 7.5 % cannot be triggered accurately.
- Select a higher trigger level range by depressing pushbutton UP and try to trigger again.

Measurement of the peak voltage

- Adjust the trigger level with the thumbwheel until the GATE indication on the display just switches on or off. The voltage of the trigger level equals the peak voltage of the input signal.

Examples:

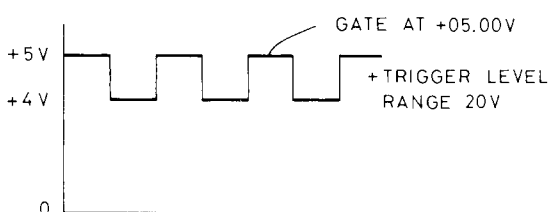
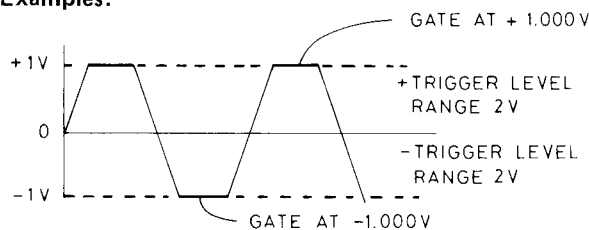

ST 3017

Fig. 21. Peak voltage measurements.

6.4.2. Extended capabilities (optional)

6.4.2.1. High tension measurements with HT probe PM 9246 (Fig. 24, page 146).

GENERAL

The HT probe PM 9246 is suitable for measuring direct voltages up to 30 kV. The attenuation factor of the probe is 1000. The measurements are carried out in the direct voltage measurement function of the PM 2521. All the facilities that are valid in the direct voltage measurements function are also valid for the HT measurements.

HIGH TENSION MEASUREMENTS

- Select function $V_{\text{---}}$ with the function selector.
- Select the manual or automatic ranging mode with pushbutton AUTO/MAN*.

Remark:

Manual ranging is indicated with a * on the display.

In automatic ranging mode the UP level is 21000 and the DOWN level is 01800.

- Select in manual ranging mode the correct range with pushbuttons UP or DOWN.

Remark:

Available ranges are:

200.00	mV
2.0000	V
20.000	V
200.00	V
2000.0	V

Range 2000 V is no being used with HT measurements.

Overload is indicated with OL on the display (Display > 21000)

- Connect the HT probe PM 9246 to the PM 2521 as shown in Fig. 24, page 146.
- Select 10 M impedance on the probe and measure the high voltage.

Remark:

The polarity indicated is that of the V terminal with respect to the 0 terminal.

With the PM 9246 voltages up to 30 kV can be measured. The attenuation factor of the probe is 1000x.

When measuring, attention must be paid to safe earth connections.

As HT measurements are made in the $V_{\text{---}}$ function of the PM 2521, the HT measurements have the same facilities as dc voltage measurements. Refer to Chapter 6.7.1.1.

6.4.2.2. High current measurements ($A_{\text{---}}$ and A_{\sim}) with SHUNT PM 9244 or CURRENT TRANSFORMER PM 9245 (Fig. 25 and 26, page 146, 150).

GENERAL

With the shunt PM 9244 it is possible to measure direct and alternating currents (max. 1 kHz) up to 31,6 A. As output voltage a selection can be made between 31,6 mV or 100 mV.

With current transformer PM 9245 it is possible to measure alternating currents over 10 A up to 100 A. The transfer factor is 1000 (100 A = 100 mA).

All facilities which are valid in the direct and alternating voltage and alternating current measurements functions are also valid for the high current measurements.

DIRECT, ALTERNATING HIGH CURRENT MEASUREMENTS WITH SHUNT PM 9244 (Fig. 25, page 146).

- Select function $V_{\text{---}}$ or $V_{\sim \text{rms}}$ with the function selector.
- Select the manual or automatic ranging mode with pushbutton AUTO/MAN*

Remark:

Manual ranging is indicated with a * on the display.

In automatic ranging mode the UP level is 210000 and the DOWN level is 01800.

- Select in manual ranging mode the correct range with pushbuttons UP or DOWN.

Remark:

Available ranges are:

200.00	mV
2.0000	V
20.000	V
200.00	V
2000.0	V

Only range 200 mV is being used. Overload is indicated with OL on the display.

- Connect the shunt PM 9244 to the PM 2521 as shown in figure 25, page 146.

Remark:

There are two current ranges available on the PM 9244 viz.: 10 A and 31.6 A.

As output voltage a selection can be made between 31.6 mV or 100 mV.

10 A	→	100 mV	10 A	→	31.6 mV
31.6 A	→	100 mV	31.6 A	→	31.6 V

Alternating currents may be measured up to 1 kHz. As the high current measurements with the PM 9244 are made in the $V_{\text{---}}$ and $V_{\sim \text{rms}}$ function of the PM 2521, they have the same facilities as direct and alternating voltage measurements. Refer to Chapter 6.7.1.1. and Chapter 6.7.1.2.

ALTERNATING CURRENT MEASUREMENTS WITH CURRENT TRANSFORMER PM 9245 (Fig. 26, page 150).

- Select function $A\sim$ rms with the function selector.
- Select the manual or automatic ranging mode with pushbutton AUTO/MAN*

Remark:

Manual ranging is indicated with a * on the display.

In automatic ranging mode the UP level is 2100 and the DOWN level is 0180.

- Select in manual ranging mode the correct range with pushbuttons UP or DOWN.

Remark:

Available ranges are:	mA terminal	0.2 A –20 A terminal
	2.000 μ A	200.0 mA
	20.00 μ A	2.000 A
	200.0 μ A	20.00 A
	2.000 mA	
	20.00 mA	

Only ranges 200 mA or lower are being used.

Overload is indicated with OL on the display (Display > 2100).

- Connect the current transformer PM 9245 to the PM 2521 as shown in Fig. 26, page 150.

Remark:

Before measuring, always connect the current transformer to the PM 2521 first. Avoid contamination of the core-parts. The transfer factor of the PM 9245 is 1000 (100 A = 100 mA). The frequency range is 45 Hz up to 1 kHz.

As the high current measurements with the PM 9245 are made in the $A\sim$ rms function of the PM 2521, they have the same facilities as the alternating current measurements. Refer to Chapter 6.4.1.5.

6.4.2.3. Data hold measurements with probe PM 9263 (Fig. 27, page 150).

GENERAL

With the data hold probe PM 9263 the data on the display can be frozen while measuring. The data hold mode is valid for all functions except the s functions. In the s function the data hold mode switches on the special trigger mode (Refer to chapter 6.4.1.10).

DATA HOLD MEASUREMENTS

- Connect the data hold probe PM 9263 to the PM 2521 as shown in figure 27, page 150.
- Select the desired function and measuring mode.
- Connect a zero lead to the 0 input of the probe.
 - This can be done in the following ways:
 - With a separate banana-plug lead connected to the "0" input of the probe. This lead is not included in the delivery of the probe.
 - With a zeroing clip-on cable supplied with the probe on the probe-tip.
- Select the most suitable test pin for the probe-tip.
- Push the slide switch (white ring) on the probe in position RUNNING (away from the probe-tip).
- Place the probe-tip on the measuring spot and measure the input signal.
- Push the slide-switch, while measuring to position HOLD (towards the probe-tip). The data on the display is now held (frozen).

Remark:

Only the data on the display is held. Meanwhile the PM 2521 continues measuring.

The maximum voltage between probe-tip $V\Omega$ and 0 is 30Vrms.

6.4.2.4. High frequency measurements with HF probe PM 9210 and accessory set PM 9212 (Fig. 28, page 150).

GENERAL

The HF probe PM 9210 is suitable for measuring HF voltages from 150 mV to 15 V in a frequency range from 100 kHz to 1 GHz.

For HF voltages from 15 V to 200 V a capacitive attenuator with an adjustable transfer ratio of 100:1 which is included in the accessory set PM 9212.

HIGH FREQUENCY MEASUREMENTS

- Select function $V_{\text{---}}$ with the function selector.
- Select the manual or automatic ranging mode with pushbutton AUTO/MAN*.

Remark:

Manual ranging is indicated with a * on the display.

In automatic ranging mode the UP level is 21000 and the DOWN level is 01800.

- Select in manual ranging mode the correct range with pushbuttons UP or DOWN.

Remark:

Available ranges are: 200.00 mV
 2.0000 V
 20.000 V
 200.00 V
 2000.0 V

Only ranges 200 mV, 2 V and 20 V are being used. Overload is indicated with OL on the display (Display > 21000).

- Connect the HF probe PM 9210 to the PM 2521 as shown in figure 28, page 150.

Remark:

To ensure reliable results when using probe PM 9210, special attention should be paid to the earthing when measuring at high frequencies. The connection between the object to be measured and the probe should therefore be as short as possible and the earthing of the probe should as far as possible be free from self-inductance. The accuracy depends on the way in which the earthing is established. A suitable earthing point will not always be available in the immediate vicinity of the point to be measured. It is advisable, therefore, to perform the measurements via the T-piece (PM 9212). For accurate measurements above approx. 100 MHz, the use of the T-piece is imperative. To enable measurements in the non-linear range, a calibration chart is supplied with the probe.