

μA78MG • μA79MG 4-Terminal Adjustable Voltage Regulators

Linear Division Voltage Regulators

Description

The μA78MG and μA79MG are 4-terminal adjustable voltage regulators. They are designed to deliver continuous load currents of up to 500 mA with a maximum input voltage of +40 V for the positive regulator μA78MG and -40 V for the negative regulator μA79MG. Output current capability can be increased to greater than 10 A through use of one or more external transistors. The output voltage range of the μA78MG positive voltage regulator is 5.0 V to 30 V and the output voltage range of the negative μA79MG is -30 to -2.2 V. For systems requiring both a positive and negative, the μA78MG and μA79MG are excellent for use as a dual tracking regulator. These 4-terminal voltage regulators are constructed using the Fairchild Planar process.

- Output Current In Excess Of 0.5 A
- μA78MG Positive Output Voltage +5.0 To +30 V
- μA79MG Negative Output Voltage -30 V To -2.2 V
- Internal Thermal Overload Protection
- Internal Short Circuit Current Protection
- Output Transistor Safe-Area Protection

Absolute Maximum Ratings

Storage Temperature Range	-65°C to +150°C
Operating Junction Temperature Range	0°C to 150°C
Lead Temperature (soldering, 10 s)	265°C
Internal Power Dissipation	Internally Limited
Input Voltage	
μA78MGC	+40 V
μA79MGC	-40 V
Control Lead Voltage	
μA78MGC	$0 \text{ V} \leq V+ \leq V_O$
μA79MGC	$V_{O-} \leq -V \leq 0 \text{ V}$

Connection Diagram μA78MG Power Watt (Top View)

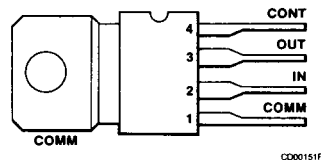

CD00151F

Heat sink tabs connected to input through device substrate. Not recommended for direct electrical connection.

Order Information

Device Code	Package Code	Package Description
μA78MGU1C	8Z	Molded Power Pack

Connection Diagram μA79MG Power Watt (Top View)

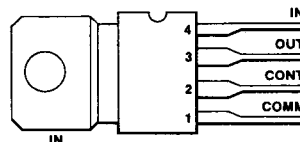

CD00151F

Heat sink tabs connected to input through device substrate. Not recommended for direct electrical connection.

Order Information

Device Code	Package Code	Package Description
μA79MGU1C	8Z	Molded Power Pack

μA78MG Equivalent Circuit

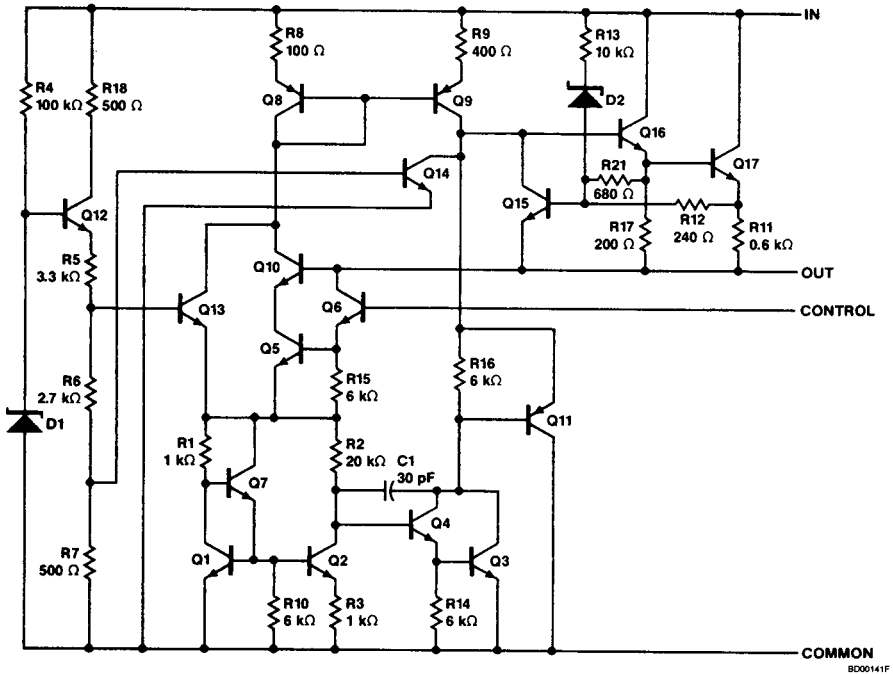

μA79MG Equivalent Circuit (Note 1)

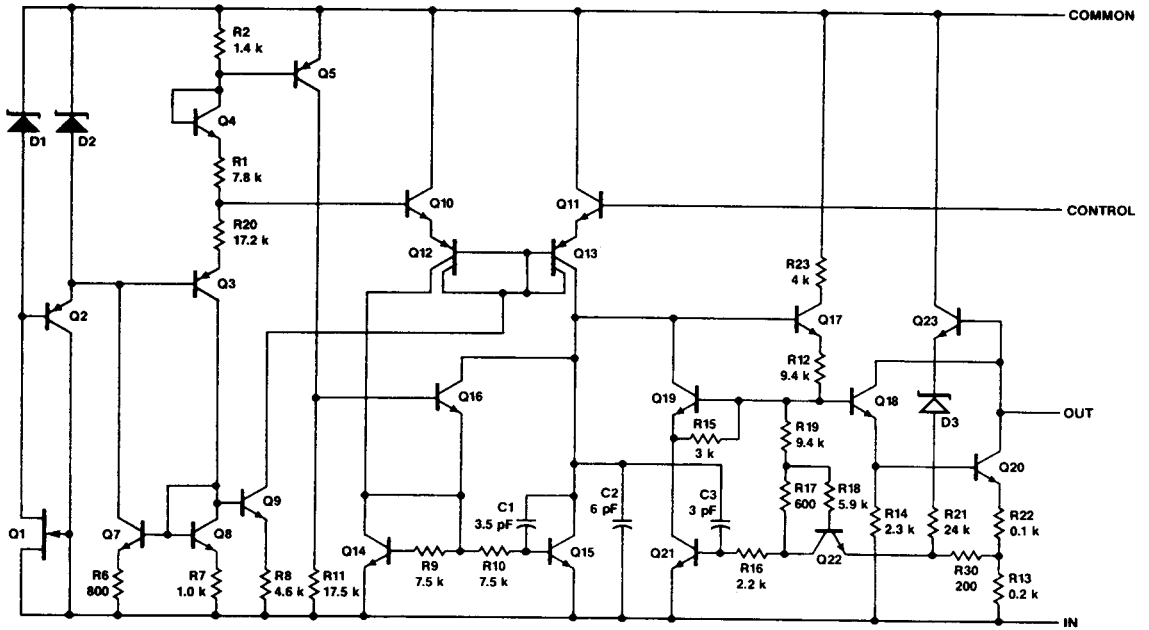

Note

1. Resistor values in Ω unless otherwise noted.

μA78MGC

Electrical Characteristics $0^{\circ}\text{C} \leq T_A \leq 125^{\circ}\text{C}$ for μA78MGC, $V_I = 10\text{ V}$, $I_O = 350\text{ mA}$, $C_I = 0.33\text{ }\mu\text{F}$, $C_O = 0.1\text{ }\mu\text{F}$, Test Circuit 1, unless otherwise specified.

Symbol	Characteristic	Condition ^{1,3}		Min	Typ	Max	Unit
V_{IR}	Input Voltage Range	$T_J = 25^{\circ}\text{C}$		7.5		40	V
V_{OR}	Output Voltage Range	$V_I = V_O + 5.0\text{ V}$		5.0		30	V
V_O	Output Voltage Tolerance	$V_O + 3.0\text{ V} \leq V_I \leq V_O + 15\text{ V}$, $5.0\text{ mA} \leq I_O \leq 350\text{ mA}$, $P_D \leq 5.0\text{ W}$, $V_{I\text{ Max}} = 38\text{ V}$	$T_J = 25^{\circ}\text{C}$			4.0	%(V_O)
						5.0	
$V_{O\text{ LINE}}$	Line Regulation	$T_J = 25^{\circ}\text{C}$, $I_O = 200\text{ mA}$, $V_O \leq 10\text{ V}$, ($V_O + 2.5\text{ V}$) $\leq V_I \leq (V_O + 20\text{ V})$, $T_J = 25^{\circ}\text{C}$, $I_O = 200\text{ mA}$, $V_O \geq 10\text{ V}$				1.0	%(V_O)
$V_{O\text{ LOAD}}$	Load Regulation	$T_J = 25^{\circ}\text{C}$, $5.0\text{ mA} \leq I_O \leq 500\text{ mA}$, $V_I = V_O + 7.0\text{ V}$				1.0	%(V_O)
I_C	Control Lead Current	$T_J = 25^{\circ}\text{C}$			1.0	6.0	μA
						7.0	
I_Q	Quiescent Current	$T_J = 25^{\circ}\text{C}$			2.8	5.0	mA
						6.0	
RR	Ripple Rejection	$I_O = 125\text{ mA}$, $8.0\text{ V} \leq V_I \leq 18\text{ V}$, $V_O = 5.0\text{ V}$, $f = 2400\text{ Hz}$		62	80		dB
N_O	Output Noise Voltage	$10\text{ Hz} \leq f \leq 100\text{ kHz}$, $V_O = 5.0\text{ V}$			8	40	μV/ V_O
V_{DO}	Dropout Voltage ²				2	2.5	V
I_{OS}	Short Circuit Current	$V_I = 35\text{ V}$, $T_J = 25^{\circ}\text{C}$				600	mA
I_{pk}	Peak Output Current	$T_J = 25^{\circ}\text{C}$		0.4	0.8	1.4	A
$\Delta V_O / \Delta T$	Average Temperature Coefficient of Output Voltage	$V_O = 5.0\text{ V}$, $I_O = 5.0\text{ mA}$	$T_A = -55^{\circ}\text{C}$ to $+25^{\circ}\text{C}$			0.4	mV/ $^{\circ}\text{C}$ / V_O
			$T_A = 25^{\circ}\text{C}$ to 125°C			0.3	
V_C	Control Lead Voltage (Reference)	$T_J = 25^{\circ}\text{C}$		4.8	5.0	5.2	V
				4.75		5.25	

6

μA79MGC

Electrical Characteristics 0°C ≤ T_J ≤ 125°C for μA79MGC, V_I = -14 V, I_O = 350 mA, C_I = 2.0 μF, C_O = 1.0 μF, Test Circuit 2, unless otherwise specified.

Symbol	Characteristic	Condition ^{1,4,5}		Min	Typ	Max	Unit
V _{IR}	Input Voltage Range	T _J = 25°C		-40		-7.0	V
V _{OR}	Output Voltage Range	V _I = V _O - 5.0 V		-30		-2.23	V
V _O	Output Voltage Tolerance	V _O - 15 V ≤ V _I ≤ V _O - 3.0 V, 5.0 mA ≤ I _O ≤ 350 mA, P _D ≤ 5.0 W, V _I Max = -38 V	T _J = 25°C			4.0	% (V _O)
						5.0	
V _O LINE	Line Regulation	T _J = 25°C, I _O = 200 mA, V _O ≤ -10 V, (V _O - 20 V) ≤ V _I ≤ (V _O - 2.5 V), T _J = 25°C, I _O = 200 mA, V _O ≤ -10 V				1.0	% (V _O)
V _O LOAD	Load Regulation	V _I = V _O - 7.0 V, 5.0 mA ≤ I _O ≤ 500 mA, T _J = 25°C				1.0	% (V _O)
I _C	Control Lead Current	T _J = 25°C				2.0	μA
						3.0	
I _Q	Quiescent Current	T _J = 25°C			0.5	2.5	mA
						3.5	
RR	Ripple Rejection	T _J = 25°C, I _O = 125 mA, V _I = -13 V V _O = -5.0 V, f = 2400 Hz		50			dB
N _O	Noise	10 Hz ≤ f ≤ 100 kHz, V _O = -8.0 V, I _L = 50 mA			25	80	μV/ V _O
V _{DO}	Dropout Voltage				1.1	2.3	V
I _{OS}	Short Circuit Current	V _I = 35 V, T _J = 25°C				600	mA
I _{pk}	Peak Output Current			0.4	0.65	1.4	mA
ΔV _O /ΔT	Average Temperature Coefficient of Output Voltage	V _O = -5.0 V, I _O = -5.0 mA	T _A = -55°C to +25°C			0.3	mV/ °C/ V _O
			T _A = 25°C to 125°C			0.3	
V _C	Control Lead Voltage (Reference)	T _J = 25°C		-2.32	-2.23	-2.14	V
				-2.35		-2.11	

Notes

- V_O is defined for the μA78MGC as $V_O = -\frac{R1 + R2}{R2} (5.0)$. The μA79MGC as $V_O = \frac{R1 + R2}{R2} (-2.23)$.
- Dropout voltage is defined as that input/output voltage differential which causes the output voltage to decrease by 5% of its initial value.
- All characteristics except noise voltage and ripple rejection ratio are measured using pulse techniques (t_w ≤ 10 ms, duty cycle ≤ 5%). Output voltage changes due to changes in internal temperature must be taken into account separately.
- The convention for negative regulators is the Algebraic value, thus -15 V is less than -10 V.
- All characteristics except noise voltage and ripple rejection ratio are measured using pulse techniques (t_w ≤ 10 ms, duty cycle ≤ 5%). Output voltage changes due to changes in internal temperature must be taken into account separately.

Typical Performance Curves For μ A78MG

Peak Output Current vs Input/Output Differential Voltage

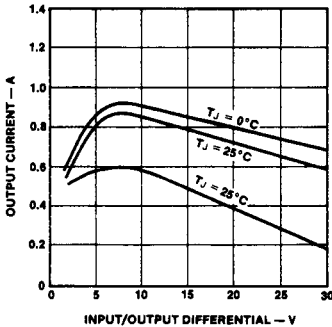

PC01481F

Quiescent Current vs Input Voltage

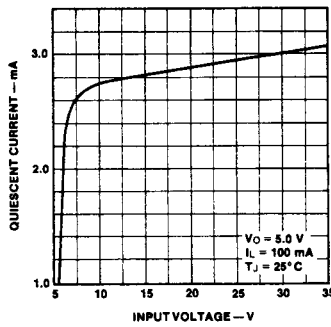

PC01491F

Control Current vs Temperature

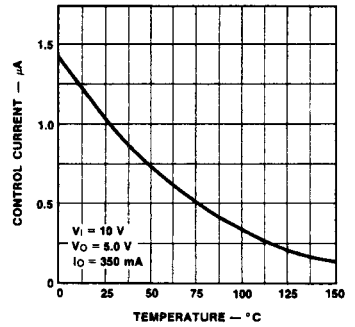

PC01501F

Differential Control Voltage vs Input Voltage

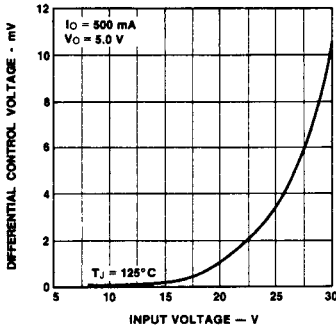

PC01511F

Differential Control Voltage vs Output Current

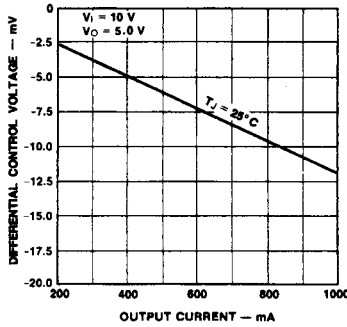

PC01521F

Ripple Rejection vs Output Voltage

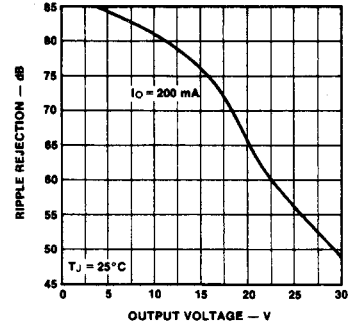

PC01531F

Dropout Voltage vs Junction Temperature

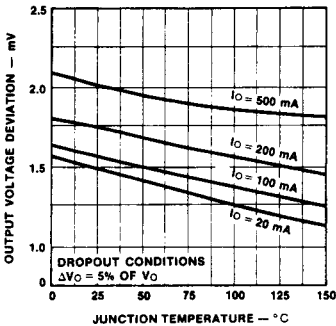

PC01541F

Ripple Rejection vs Frequency

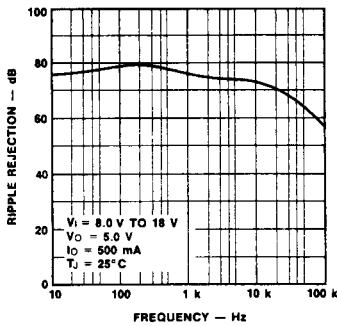

PC01551F

Load Transient Response

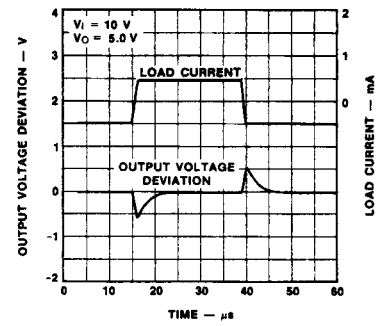

PC01561F

Typical Performance Curves For μ A78MG (Cont.)

Line Transient Response

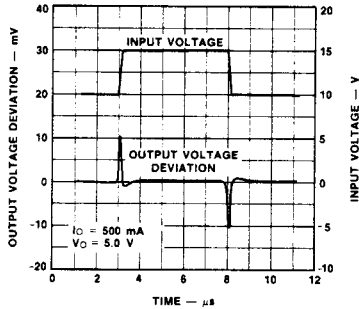

PC01571F

Typical Performance Curves For μ A79MG

Peak Output Current vs Input/Output Differential Voltage

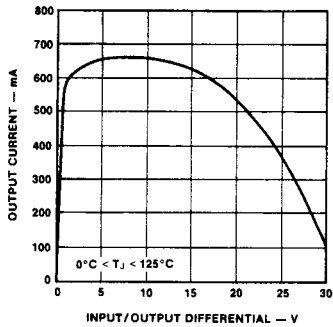

PC01581F

Quiescent Current vs Input Voltage

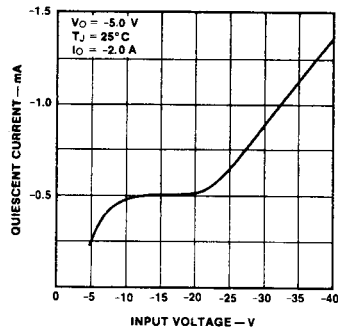

PC01591F

Control Current vs Temperature

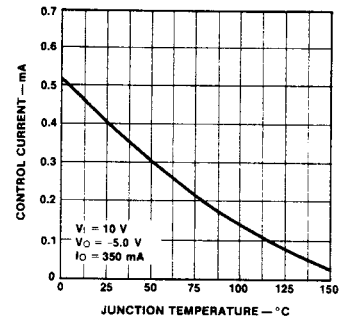

PC01601F

Differential Control Voltage vs Input Voltage

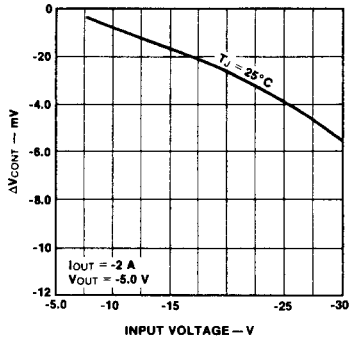

PC11670F

Differential Control Voltage vs Output Current

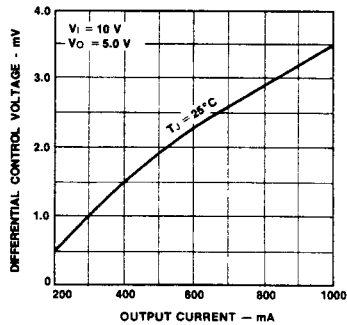

PC01621F

Ripple Rejection vs Output Voltage

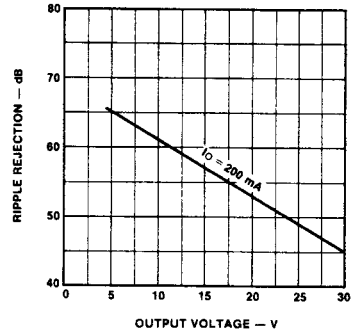

PC01631F

Typical Performance Curves For μA79MG (Cont.)

Dropout Voltage vs Junction Temperature

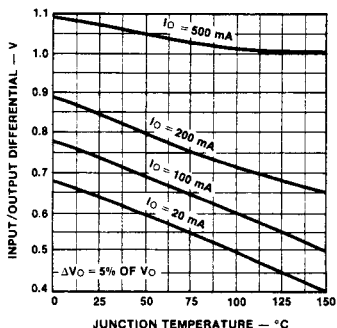

PC01641F

Load Transient Response

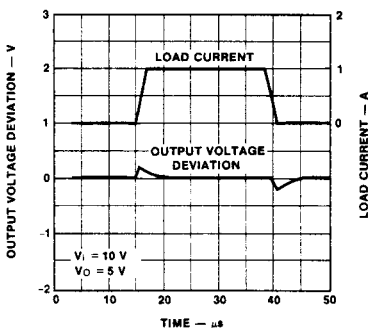

PC01661F

Ripple Rejection vs Frequency

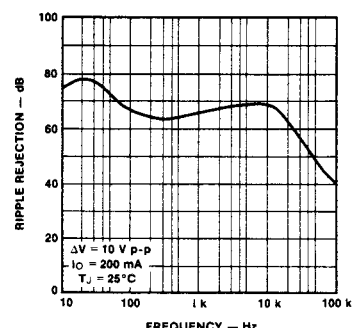

PC01651F

Typical Performance Curve For μA78MG and μA79MG

Worst Case Power Dissipation vs Ambient Temperature

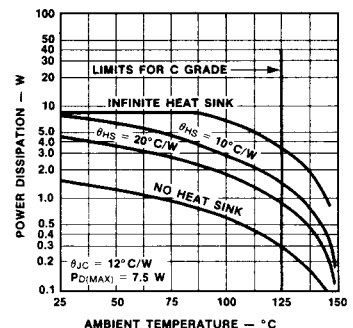

PC01686F

Line Transient Response

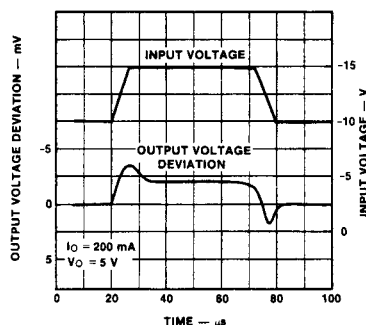

PC01671F

Design Considerations

The μA78MG and μA79MG variable voltage regulators have an output voltage which varies from V_{CONT} to typically

$$V_i - 2.0\text{ V by } V_O = V_{CONT} \frac{(R_1 + R_2)}{R_2}$$

The nominal reference in the μA78MG is 5.0 V and μA79MG is -2.23 V. If we allow 1.0 mA to flow in the control string to eliminate bias current effects, we can make $R_2 = 5\text{ k}\Omega$ in the μA78MG. The output voltage is then: $V_O = (R_1 + R_2)$ Volts, where R_1 and R_2 are in $\text{k}\Omega$ s.

Example: If $R_2 = 5.0\text{ k}\Omega$ and $R_1 = 10\text{ k}\Omega$ then $V_O = 15\text{ V}$ nominal, for the μA78MG; $R_2 = 2.2\text{ k}\Omega$ and $R_1 = 12.8\text{ k}\Omega$ then $V_O = -15.2\text{ V}$ nominal, for the μA79MG.

By proper wiring of the feedback resistors, load regulation of the devices can be improved significantly.

Both μA78MG and μA79MG regulators have thermal overload protection from excessive power, internal short circuit protection which limits each circuit's maximum current, and output transistor safe-area protection for reducing the

output current as the voltage across each pass transistor is increased.

Although the internal power dissipation is limited, the junction temperature must be kept below the maximum specified temperature in order to meet data sheet specifications. To calculate the maximum junction temperature or heat sink required, the following thermal resistance values should be used:

Package	Typical θ_{JC}	Max θ_{JC}	Typical θ_{JA}	Max θ_{JA}
Power Watt	8.0	12.0	70	75

$$P_{D \text{ Max}} = \frac{T_{J \text{ Max}} - T_A}{\theta_{JC} + \theta_{CA}} \text{ or}$$

$$\frac{T_{J \text{ Max}} - T_A}{\theta_{JA}} \text{ (Without a heat sink)}$$

$$\theta_{CA} = \theta_{CS} + \theta_{SA}$$

Solving for T_J :

$$T_J = T_A + P_D(\theta_{JC} + \theta_{CA}) \text{ or}$$

$$T_A + P_D\theta_{JA} \text{ (Without heat sink)}$$

Where

- T_J = Junction Temperature
- T_A = Ambient Temperature
- P_D = Power Dissipation
- θ_{JC} = Junction-to-case thermal resistance
- θ_{CA} = Case-to-ambient thermal resistance
- θ_{CS} = Case-to-heat sink thermal resistance
- θ_{SA} = Heat sink-to-ambient thermal resistance
- θ_{JA} = Junction-to-ambient thermal resistance

Typical Applications for μA78MG (Note 1)

Bypass capacitors are recommended for stable operation of the μA78MG over the input voltage and output current ranges. Output bypass capacitors will improve the transient response of the regulator.

The bypass capacitors, (0.33 μF on the input, 0.1 μF on the output) should be ceramic or solid tantalum which have good high frequency characteristics. The bypass capacitors should be mounted with the shortest leads, and if possible, directly across the regulator terminals.

Note

1. All resistor values in ohms.

Basic Positive Regulator

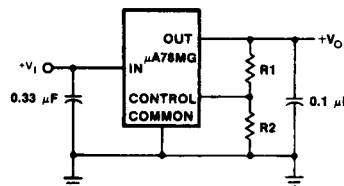

CR00191F

$$V_O = V_{CONT} \left(\frac{R1 + R2}{R2} \right)$$

Positive 5.0 V to 30 V Adjustable Regulator

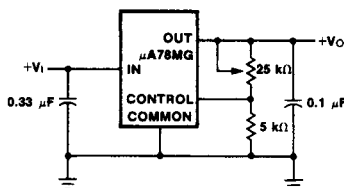

CR00201F

Positive 5.0 V to 30 V Adjustable Regulator $I_O > 1.5 \text{ A}$

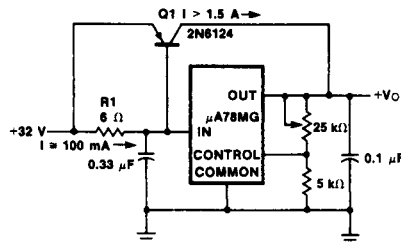

CR00211F

$$R1 = \frac{\beta V_{BE(Q1)}}{I_{R \text{ Max}}(\beta) - I_O}$$

Typical Applications for μA78MG (Note 1) (Cont.)

± 10 V, 500 mA Dual Tracking Regulator

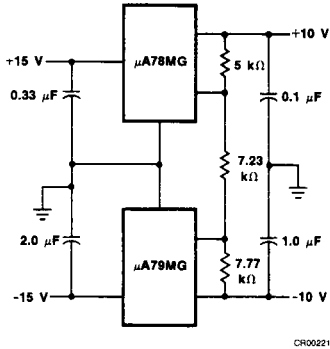

CR00221F

Note

External series pass device is not short circuit protected.

Positive High Current Short Circuit Protected Regulator

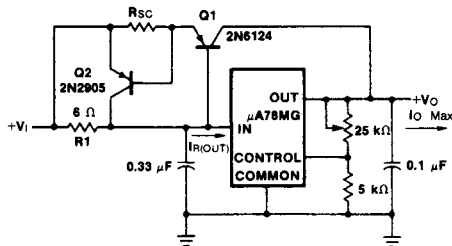

CR00231F

$$R1 = \frac{\beta V_{BE}(Q1)}{V_{R \text{ Max}}(\beta + 1) - I_{O \text{ Max}}}$$

If load is not ground referenced, connect reverse biased diodes from outputs to ground.

Output Waveform

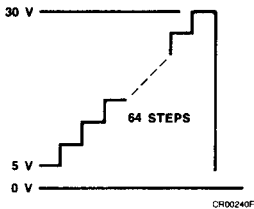

CR00240F

Note

1. All resistor values in ohms.

Positive High-Current Voltage Regulator

External Series Pass (a)

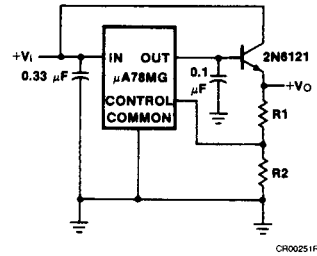

CR00251F

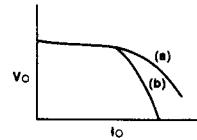

CR00261F

Short-Circuit Limit (b)

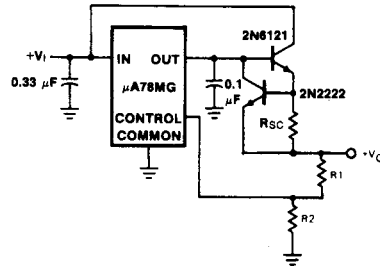

CR00271F

Typical Applications for μA79MG (Note 1)

Bypass capacitors are recommended for stable operation of the μA79MG over the input voltage and output current ranges. Output bypass capacitors will improve the transient response of the regulator.

The bypass capacitors, (2.0 μF on the input, 1.0 μF on the output) should be ceramic or solid tantalum which have good high frequency characteristics. If aluminum electrolytics are used, their values should be 10 μF or larger. The bypass capacitors should be mounted with the shortest leads, and if possible, directly across the regulator terminals.

Typical Applications for μA79MG (Note 1) (Cont.)

Negative High Current Short Circuit Protected Regulator

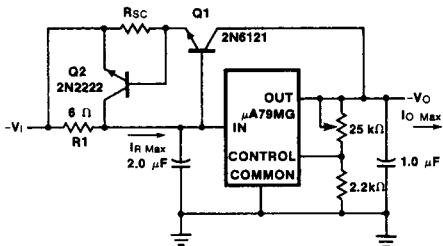

CR00281F

$$R1 = \frac{\beta V_{BE(Q1)}}{I_{R \text{ Max}}(\beta) - I_{O \text{ Max}}}$$

Basic Negative Regulator

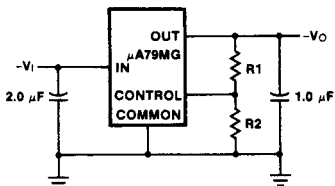

CR00291F

$$V_O = -V_{CONT} \left(\frac{R1 + R2}{R2} \right)$$

-30 V to -2.2 V Adjustable Regulator

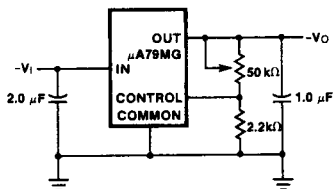

CR00301F

Note

1. All resistor values in ohms.

Negative High Current Voltage Regulator External Series Pass

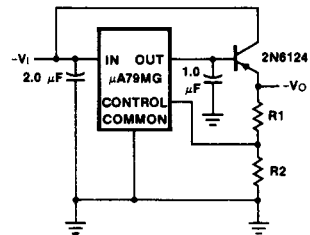

CR00311F

μA78MG Test Circuit 1

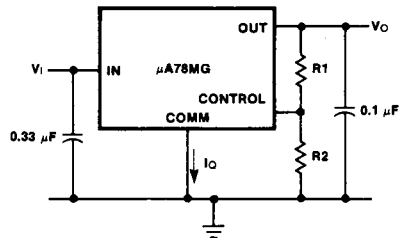

CR00321F

$$V_O = \left(\frac{R1 + R2}{R2} \right) V_{CONT}$$

V_{CONT} Nominally = 5 V

μA79MG Test Circuit 2

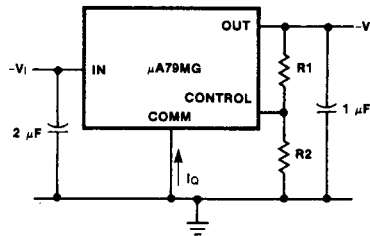

CR00331F

$$V_O = \left(\frac{R1 + R2}{R2} \right) V_{CONT}$$

V_{CONT} Nominally = -2.23 V

Recommended $R2$ current ≈ 1 mA
 $\therefore R2 = 5 \text{ k}\Omega$ ($\mu A78MG$)
 $R2 = 2.2 \text{ k}\Omega$ ($\mu A79MG$)