

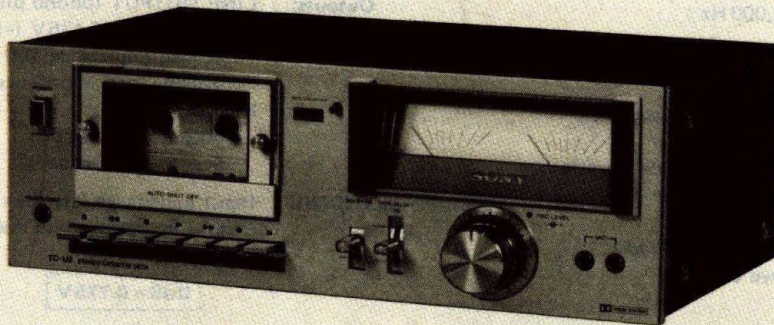

TC-U2

Canadian Model
AEP Model
UK Model
E Model



STEREO CASSETTE DECK

SAFETY-RELATED COMPONENT WARNING!!

COMPONENTS IDENTIFIED BY SHADING AND MARK  ON THE SCHEMATIC DIAGRAMS, EXPLODED VIEWS AND IN THE PARTS LIST ARE CRITICAL TO SAFE OPERATION. REPLACE THESE COMPONENTS WITH SONY PARTS WHOSE PART NUMBERS APPEAR AS SHOWN IN THIS MANUAL OR IN SUPPLEMENTS PUBLISHED BY SONY.

ATTENTION AU COMPOSANT AYANT RAPPORT À LA SÉCURITÉ!!

LES COMPOSANTS IDENTIFIÉS PAR UN TRAMÉ ET UNE MARQUE  SUR LES DIAGRAMMES SCHÉMATIQUES, LES VUES EXPLODÉES ET LA LISTE DES PIÈCES SONT CRITIQUES POUR LA SÉCURITÉ DE FONCTIONNEMENT. NE REMPLACER CES COMPOSANTS QUE PAR DES PIÈCES SONY DONT LES NUMÉROS SONT DONNÉS DANS CE MANUEL OU DES SUPPLÉMENTS PUBLIÉS PAR SONY.

'Dolby' and the double-D symbol are the trade marks of Dolby Laboratory Inc. Noise reduction system manufactured under license from Dolby Laboratory Inc.

SPECIFICATIONS

GENERAL

| | |
|----------------------------|---|
| Power Requirements: | 120V ac, 60 Hz (Canadian model) 240V ac, 50 Hz (UK model) 120, 220V ac, 50 Hz (AEP model) 110, 120, 220, 240V ac, adjustable; 50/60 Hz (E model) |
| Power Consumption: | 10W (Canadian model) 13W (AEP, UK, E model) |
| Dimensions: | Approx. 410 (w) x 145 (h) x 260 (d) mm 16 1/8 (w) x 5 3/4 (h) x 10 1/4 (d) inches including projecting parts and controls |
| Weight: | Approx. 5 kg, 11 lb |

TAPE RECORDER SECTION

| | |
|--------------------------------------|--|
| Track: | 4-track 2-channel stereo |
| Fast Forward and Rewind Time: | Approx. 90 seconds with Sony cassette C-60 |

— Continued on page 2 —

SONY[®]

SERVICE MANUAL

Frequency Response: DOLBY NR OFF
 With Ferri-Chrome cassette
 30-15,000 Hz
 50-13,000 Hz ± 3 dB
 With chromium dioxide cassette
 30-15,000 Hz
 50-13,000 Hz ± 3 dB
 With standard cassette
 30-13,000 Hz

Wow and Flutter: 0.08% WRMS

SN Ratio: DOLBY NR OFF
 With Ferri-Chrome cassette
 55 dB at peak level
 With chromium dioxide cassette
 53 dB at peak level
 DOLBY NR ON
 Improved by 5 dB at 1 kHz,
 10 dB above 5 kHz

Total Harmonic Distortion: 2%

Record Bias Frequency: 80 kHz

Inputs: MIC (phone jacks) 2
 sensitivity 0.25 mV (-70 dB)
 for a low-impedance microphone
 LINE IN (phono jacks) 2
 sensitivity 77.5 mV (-20 dB)
 input impedance 100 kΩ

Outputs: LINE OUTPUT (phono plugs) 2
 output level 0.435 V (-5 dB)
 at load impedance 100 kΩ
 suitable load impedance more than 10 kΩ
 HEADPHONES 1
 output level -26 dB
 at load impedance 8 Ω

REC/PB Jack (DIN): Input impedance less than 10 kΩ
 Output impedance less than 10 kΩ

0 dB = 0.775 V

MODEL IDENTIFICATIONS

- Specification Label -

Canadian model

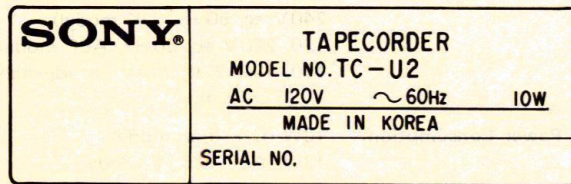

AEP model

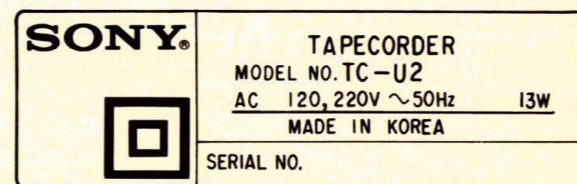

UK model

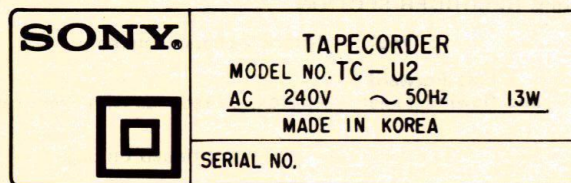

E model

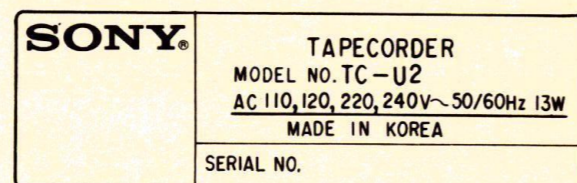

SECTION 1
 BLOCK DIAGRAM

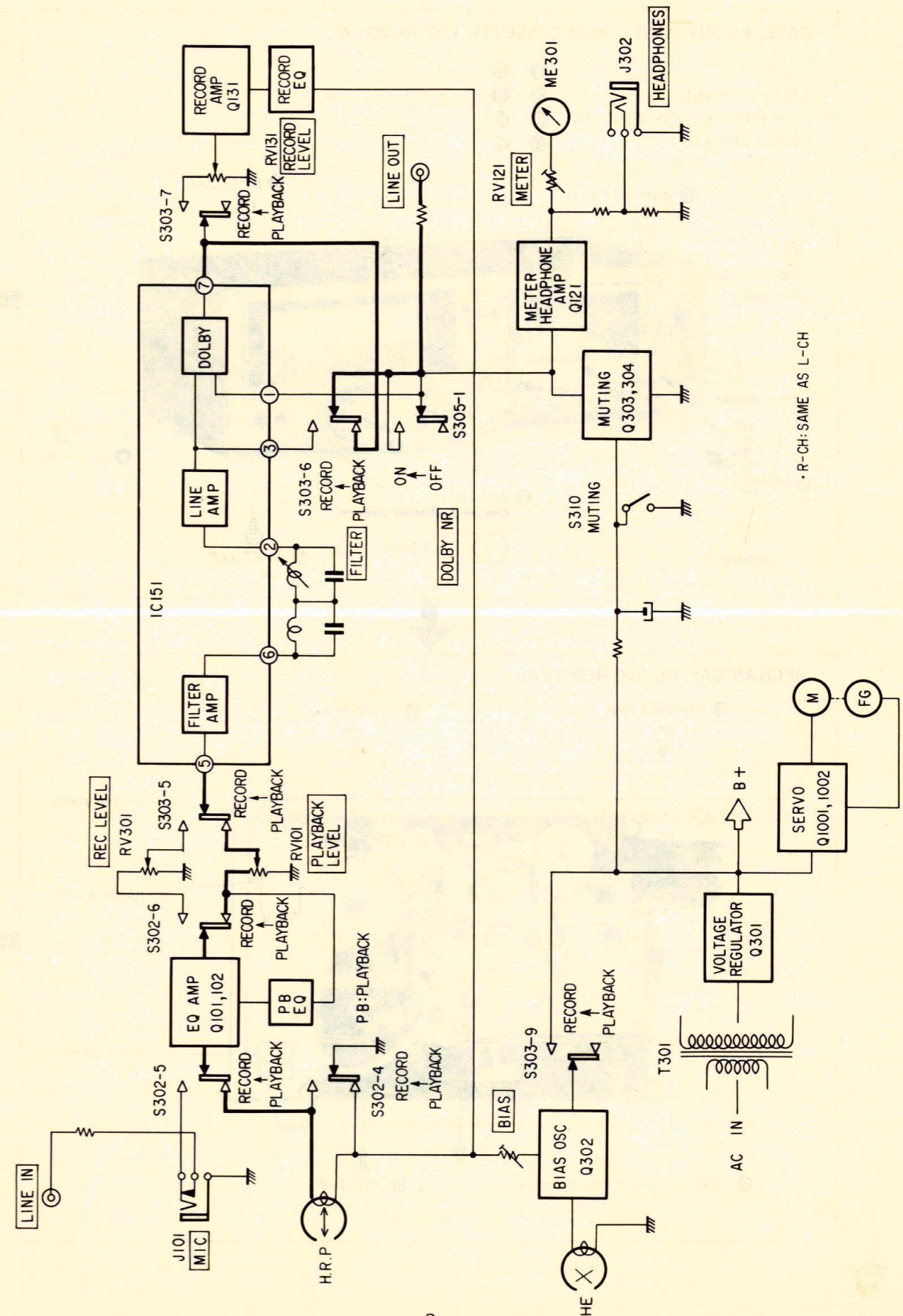

• R-CH: SAME AS L-CH

SECTION 2 DISASSEMBLY

Note: Follow the disassembly procedure in the numerical order given.

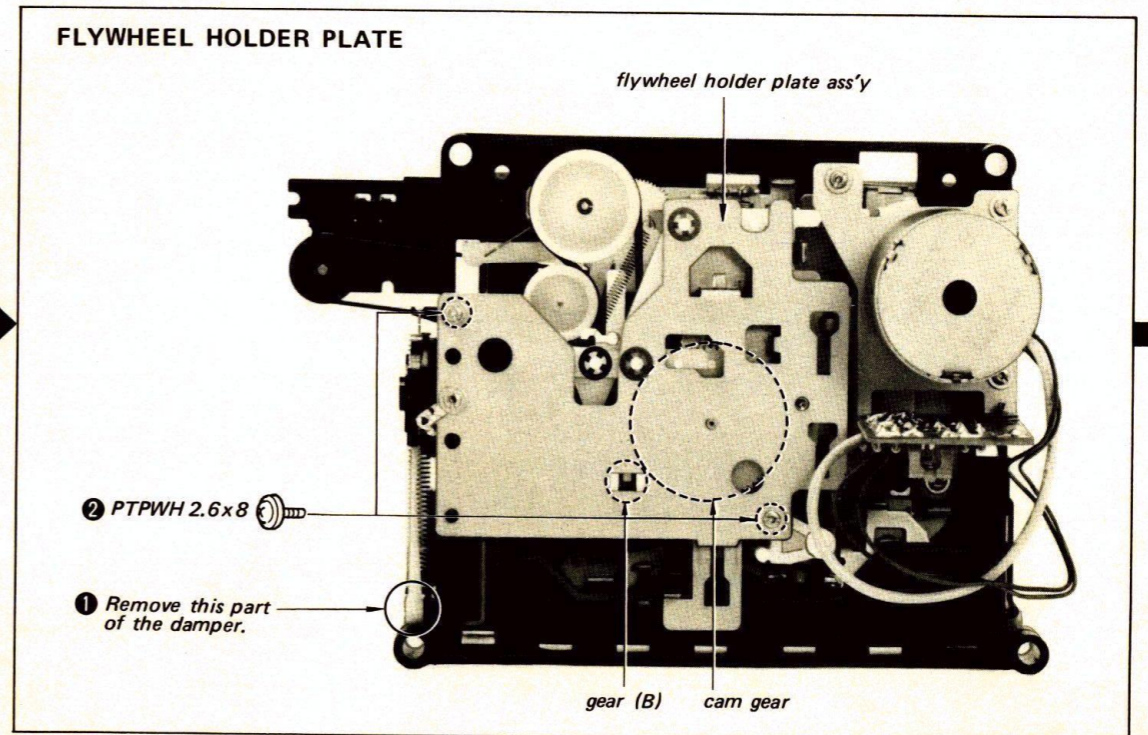
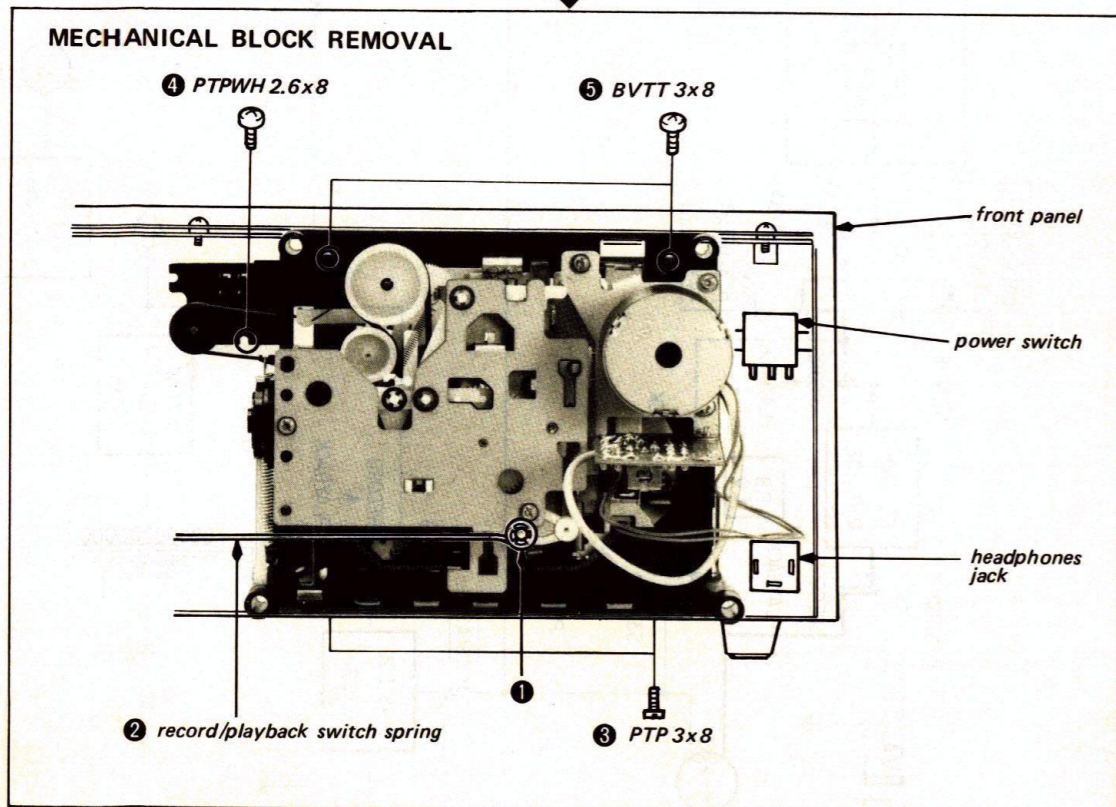
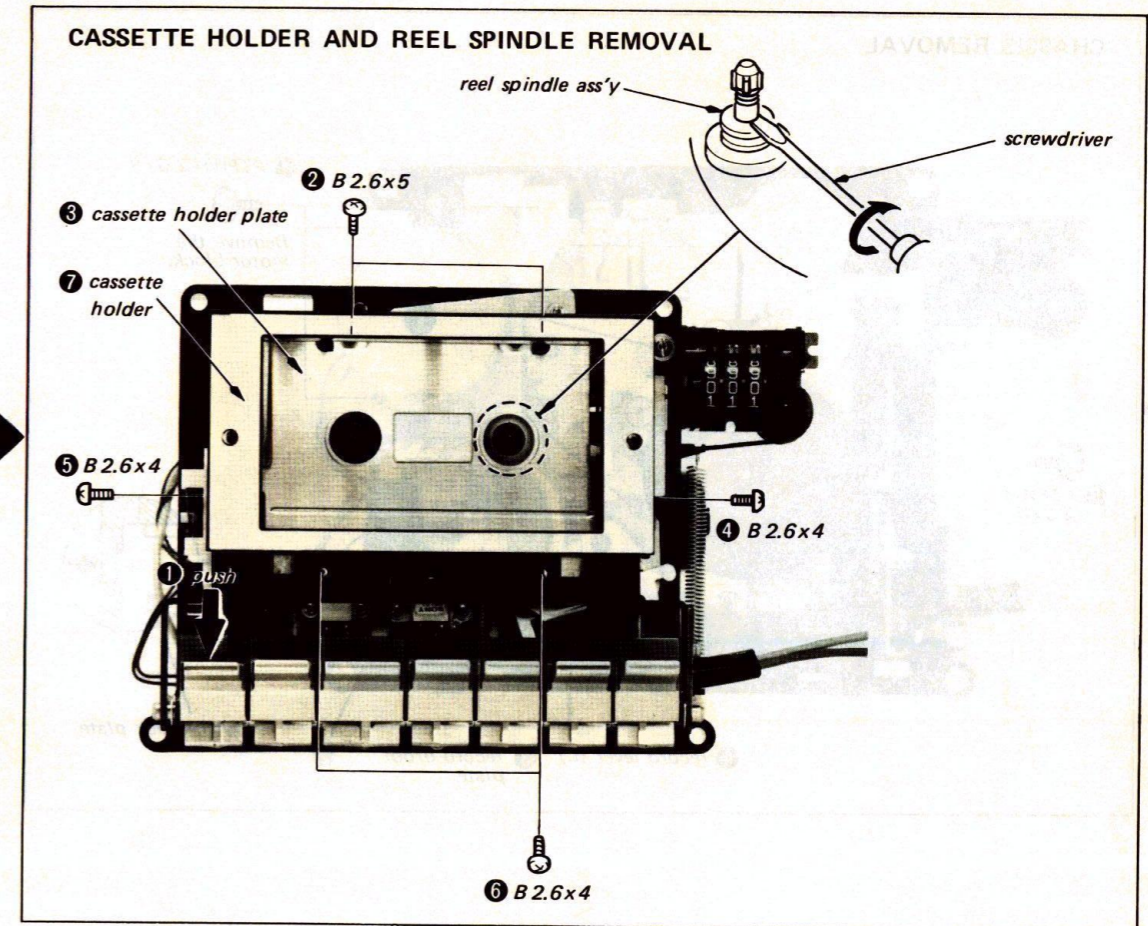
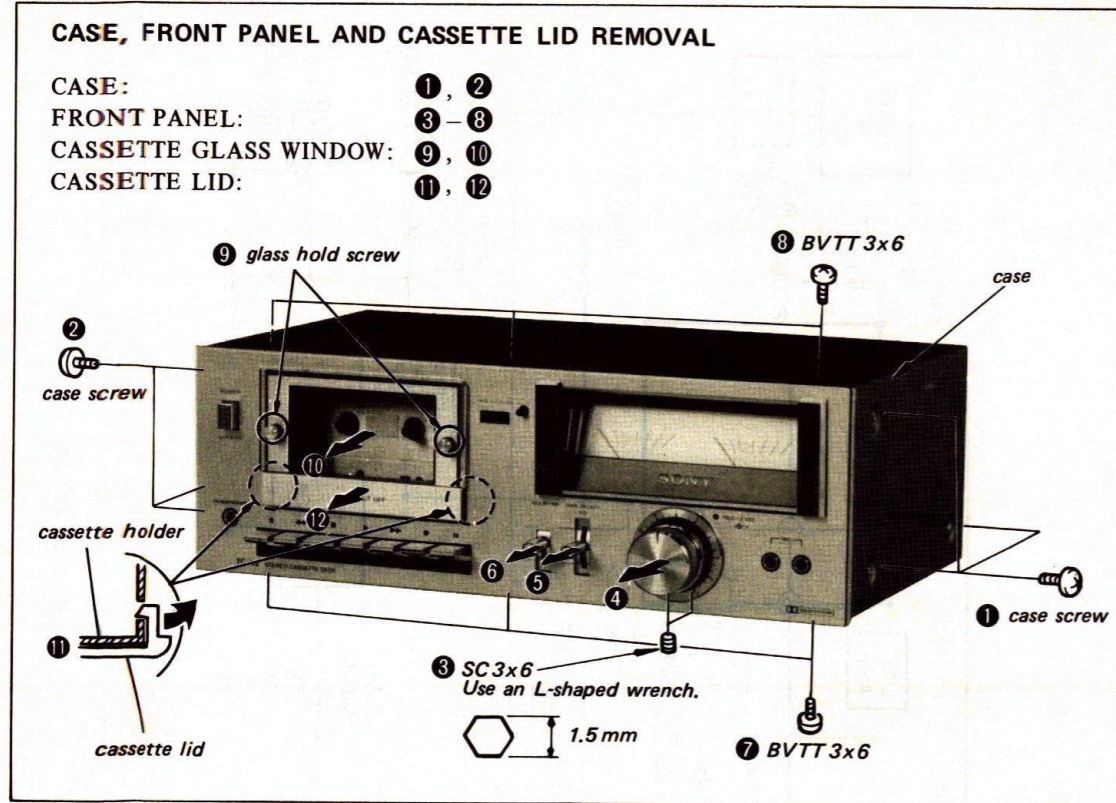

CHASSIS REMOVAL

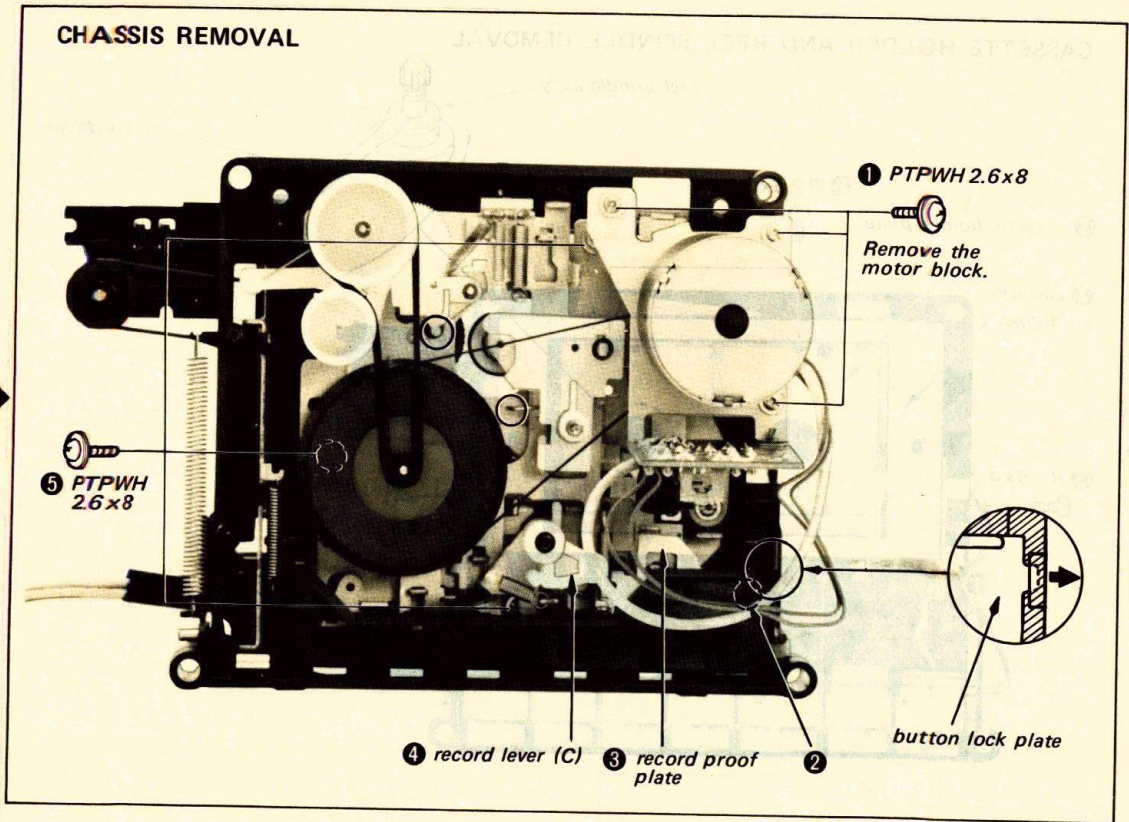

**SECTION 3
ADJUSTMENT**

3-1. MECHANICAL ADJUSTMENTS

PRECAUTION

- Clean the following parts with a denatured-alcohol-moistened swab:

| | |
|----------------------|--------------|
| record/playback head | pinch roller |
| erase head | rubber belts |
| capstan | idlers |
- Demagnetize the record/playback head with a head demagnetizer.
- Do not use a magnetized screwdriver for the adjustments.
- After the adjustments, apply a suitable locking compound to the parts adjusted.
- The adjustments should be performed with the rated power supply voltage unless otherwise noted.

Torque Adjustment

| | Torque meter | Meter reading |
|------------------------|---------------------|-----------------------------------|
| forward | CQ-101A, 102A, 103A | 25–55 g·cm (0.35–0.77 oz·inch) |
| fast-forward rewind | CQ-201A | 50–90 g·cm (0.69–1.25 oz·inch) |

Motor Pulley Height Adjustment

After replacing the motor pulley or the flywheel, this adjustment should be performed.

Procedure:

- Keep the set horizontal.
- Adjust the motor pulley height so that the drive belt is straight without twist.

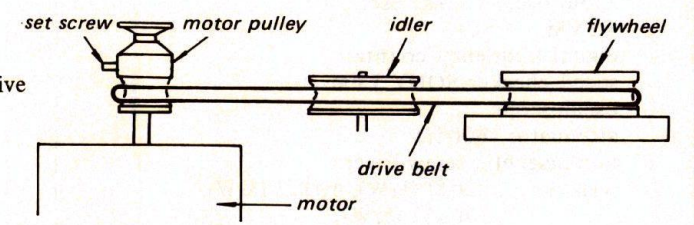

Pinch Roller Pressure Adjustment

— Playback Mode —

- Pull the spring scale.
- Slowly return the pinch roller and read the spring scale just when the pinch roller starts to rotate.
- If necessary, change the hooking position.

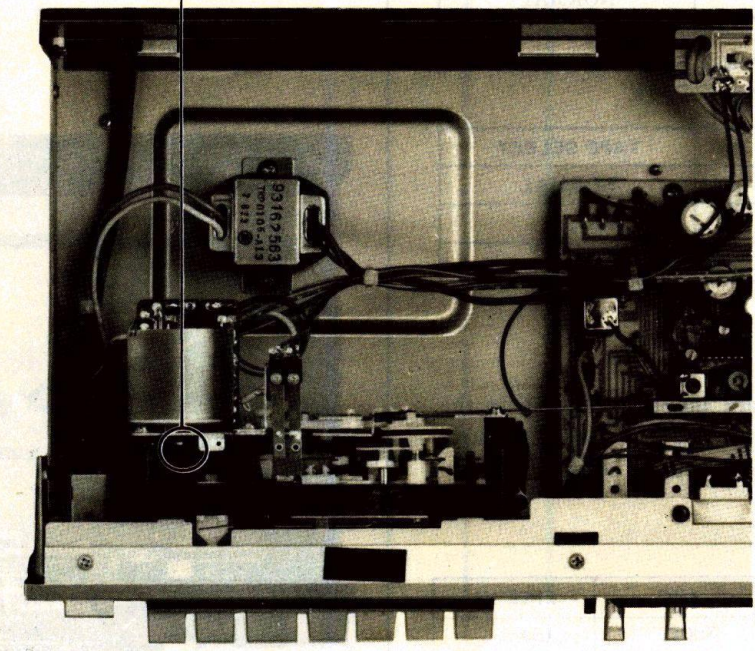
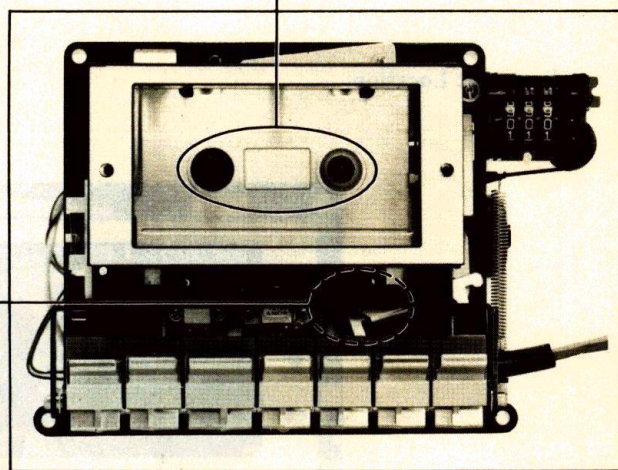
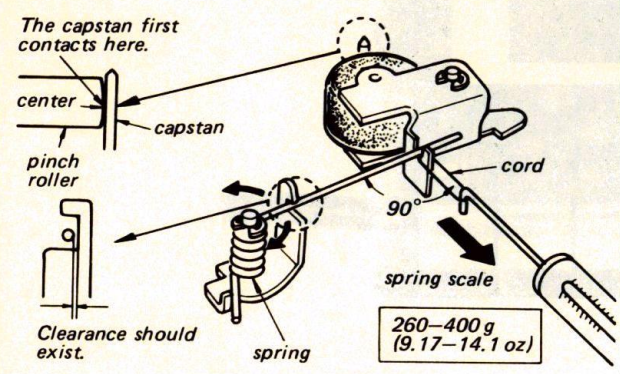

3-2. ELECTRICAL ADJUSTMENTS

Note: The adjustment should be performed in the order given in this service manual. The adjustments should be performed for both L-CH and R-CH.

Test Equipment/Tools Required:

- audio oscillator (af osc)
- VTVM
- digital frequency counter
- speed checker SONY LFM-30
- oscilloscope
- attenuator (600Ω)
- non-magnetic screwdriver
- resistors 600Ω (¼ W), 10 kΩ (¼ W), 100 kΩ (¼ W)
- blank tapes (completely erased with bulk eraser)
- SONY CS-10 (HF), CS-20 (CrO₂), CS-30 (Fe-Cr)
- SONY test tapes
 - P-4-A81S (6.3 kHz, -10 dB)
 - P-4-L81 (333 Hz, 0 dB)
 - WS-48 (3 kHz, 0 dB)

Switch Setting:

| Switch | Position |
|-------------|----------|
| DOLBY NR | OFF |
| TAPE SELECT | NORMAL |

TAPE SELECT switch settings in accordance with tape used are as follows.

| TAPE | TAPE SELECT |
|-------|------------------|
| CS-10 | NORMAL |
| CS-20 | CrO ₂ |
| CS-30 | Fe-Cr |

Standard Record:

Supply the standard input level signal to the LINE IN jack and set the REC LEVEL control to obtain the standard output level signal.

Standard Input Level

| | MIC | LINE IN |
|------------------|------------------|-----------------|
| source impedance | 300Ω | 10 kΩ |
| input level | 0.77 mV (-60 dB) | 0.25 V (-10 dB) |

Standard Output Level

| | LINE OUT | HEADPHONES |
|----------------|----------------|----------------|
| load impedance | 100 kΩ | 8Ω |
| output level | 0.44 V (-5 dB) | 25 mV (-30 dB) |

1. Tape Speed Adjustment

Procedure:

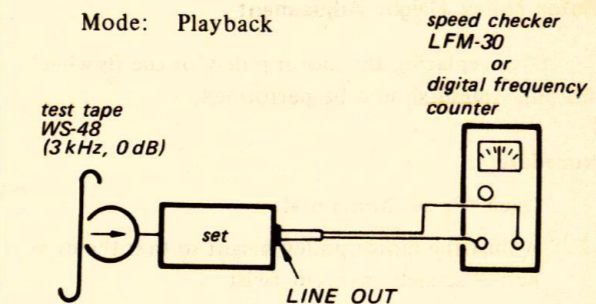

Adjust RV1001 to obtain the specified values below.

Specification:

| Speed checker | Digital frequency counter |
|---------------|---------------------------|
| -2-+3% | 2,940-3,090 Hz |

Adjustment Location:

- servo amp board -

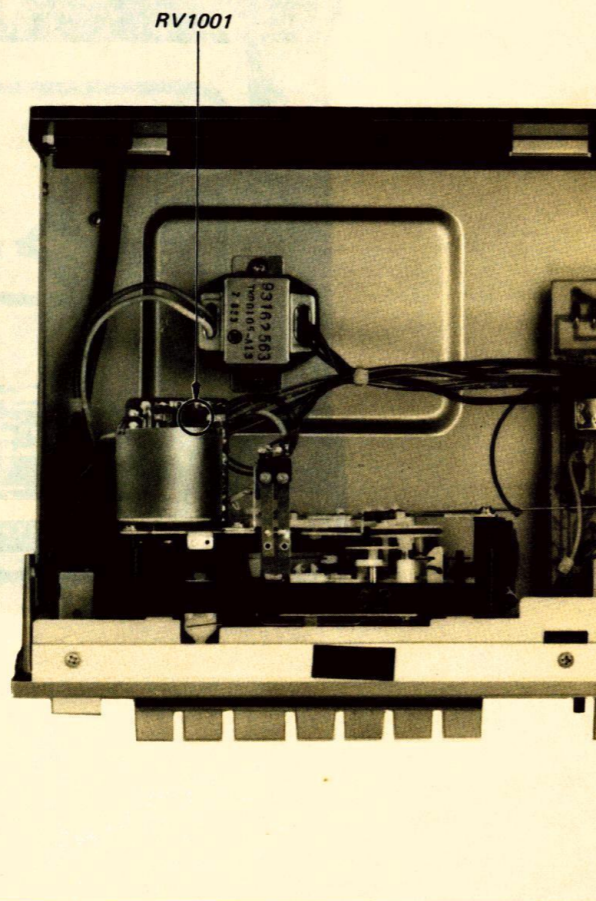

2. Record/playback Head Azimuth Adjustment

Procedure:

1. Mode: Playback

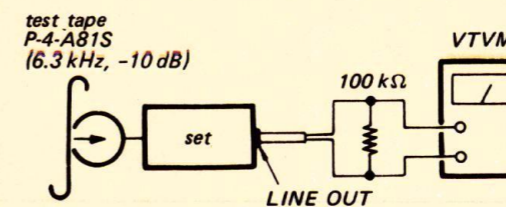

2. Turn the adjustment screw for the maximum level and set it to the mechanical mid position between L-CH and R-CH peak position.

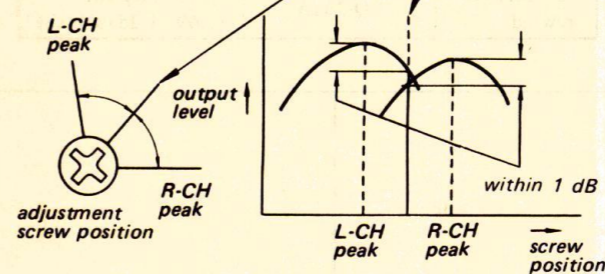

Adjustment Location:

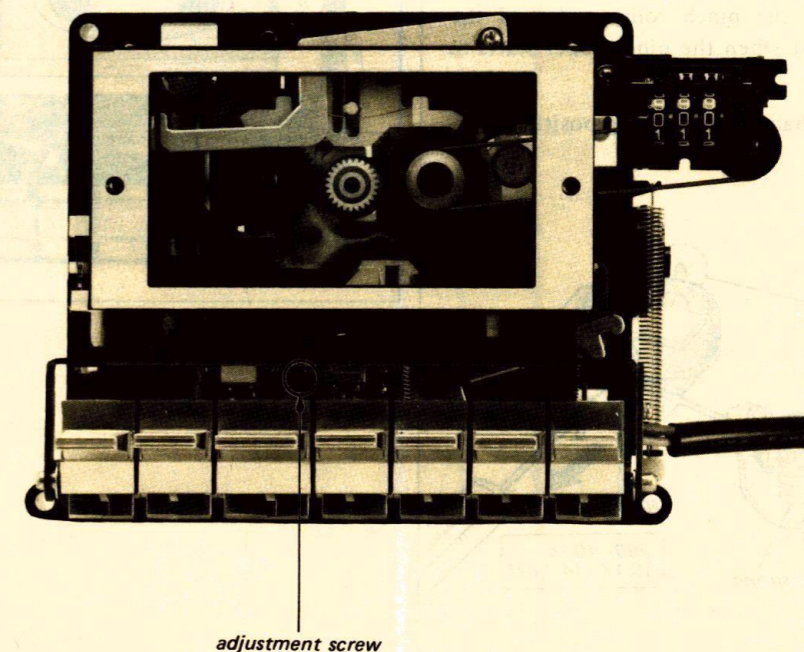

3. Mode: Playback

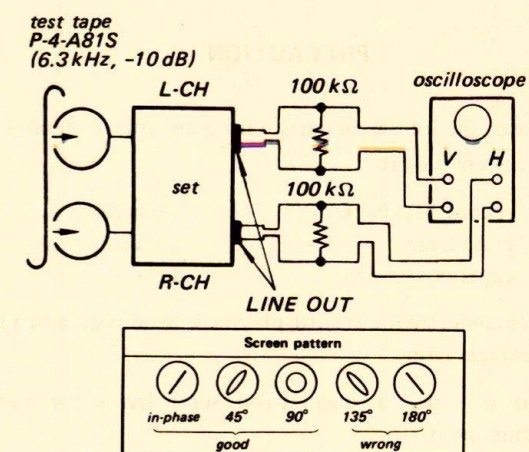

7. MPX Filter Adjustment

Procedure:

Mode: Standard record (See page 9.)
DOLBY NR switch: ON

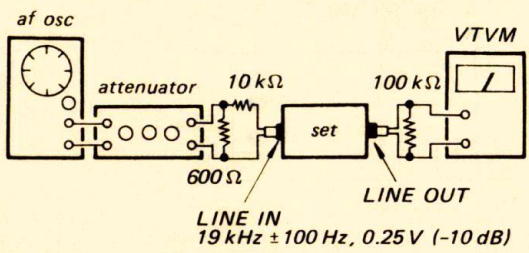

Adjust L152 (L-CH) and L252 (R-CH) for minimum VTVM reading.

4. Record Level Adjustment

Procedure:

1. Mode: Standard record (See page 9.)

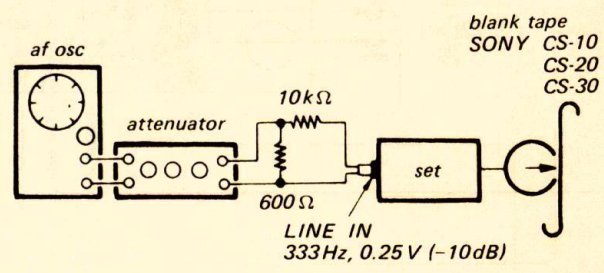

2. Mode: Playback

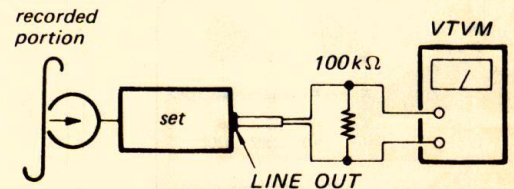

Adjust RV131 (L-CH) and RV231 (R-CH) to obtain the VTVM reading specified below.

Specification:
LINE OUT level: 0.35–0.55 V (-7 – -3 dB)

3. Playback Level Adjustment

Procedure:

1. Mode: Playback

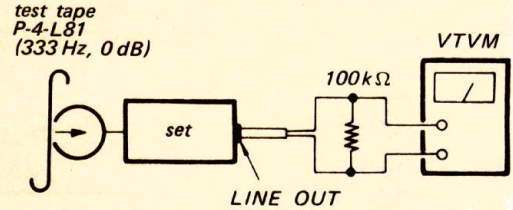

Adjust RV101 (L-CH) and RV201 (R-CH) to obtain the VTVM reading specified below.

2. Assure that the LINE OUT level does not change when the mode is changed from playback to stop several times.

Specification:
LINE OUT level: 0.49–0.62 V (-4 – -2 dB)

6. Level Meter Calibration

Procedure:

1. Mode: Standard record (See page 9.)

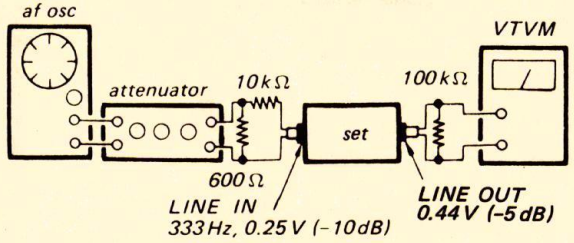

2.

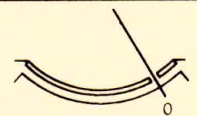
| Adjust | Level meter reading: 0VU |
|--------------|---|
| RV121 (L-CH) |  |
| RV221 (R-CH) | |

Specification:
When the LINE IN level is adjusted to make 0VU indication, VTVM reading should be 0.44 V (-5 dB).

5. Record Bias Adjustment

Procedure:

1. Mode: Standard record (See page 9.)

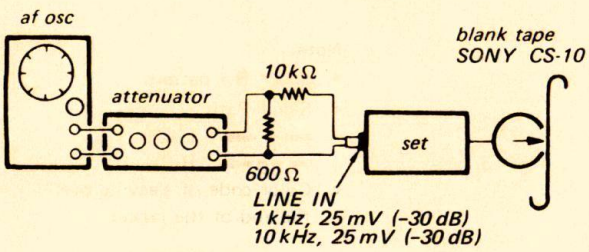

2. Mode: Playback

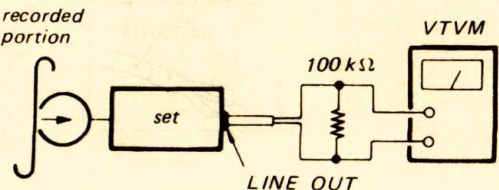

Adjust RV302 (L-CH) and RV303 (R-CH) to make 1 kHz and 10 kHz signal output levels equal.

Level difference between two output levels: 0 dB

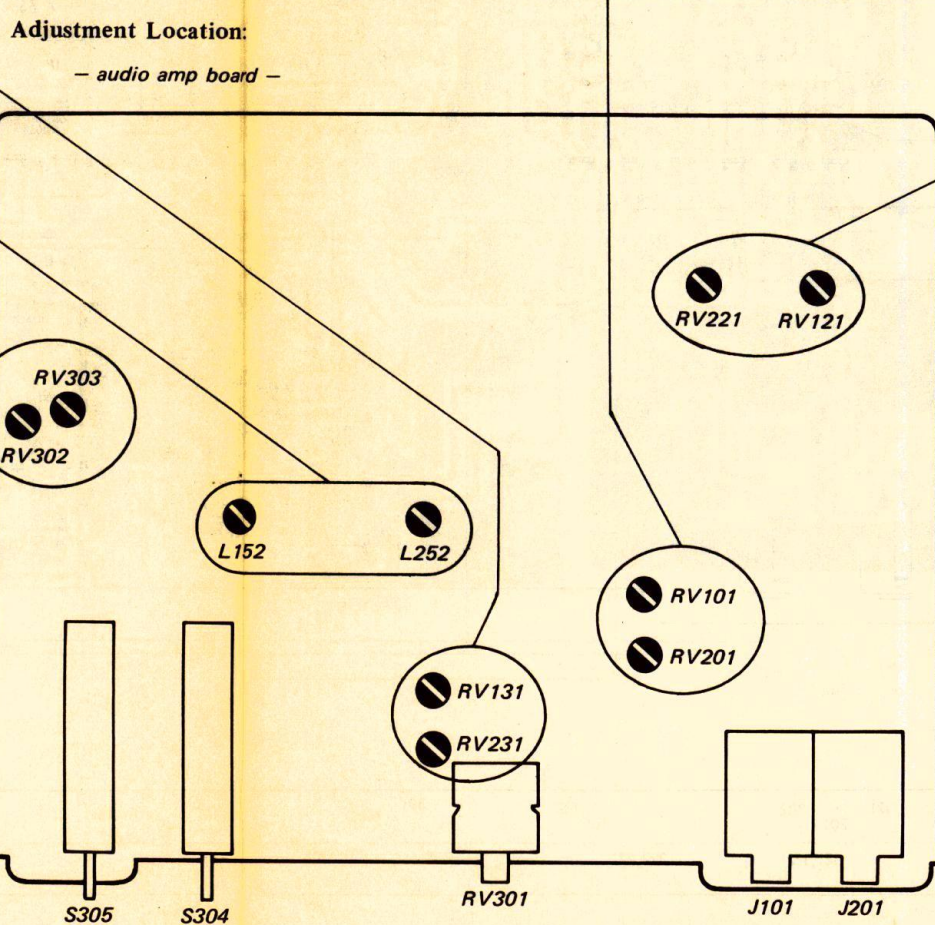

4-1. MOUNTING DIAGRAM - Conductor Side -

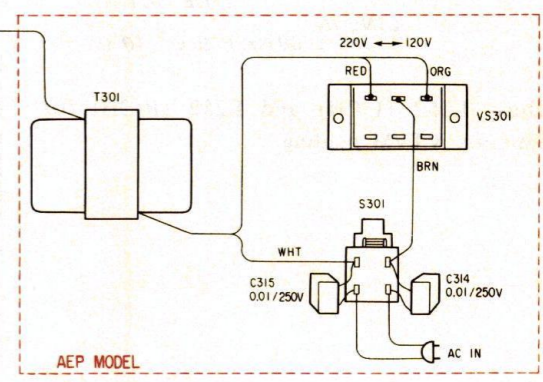
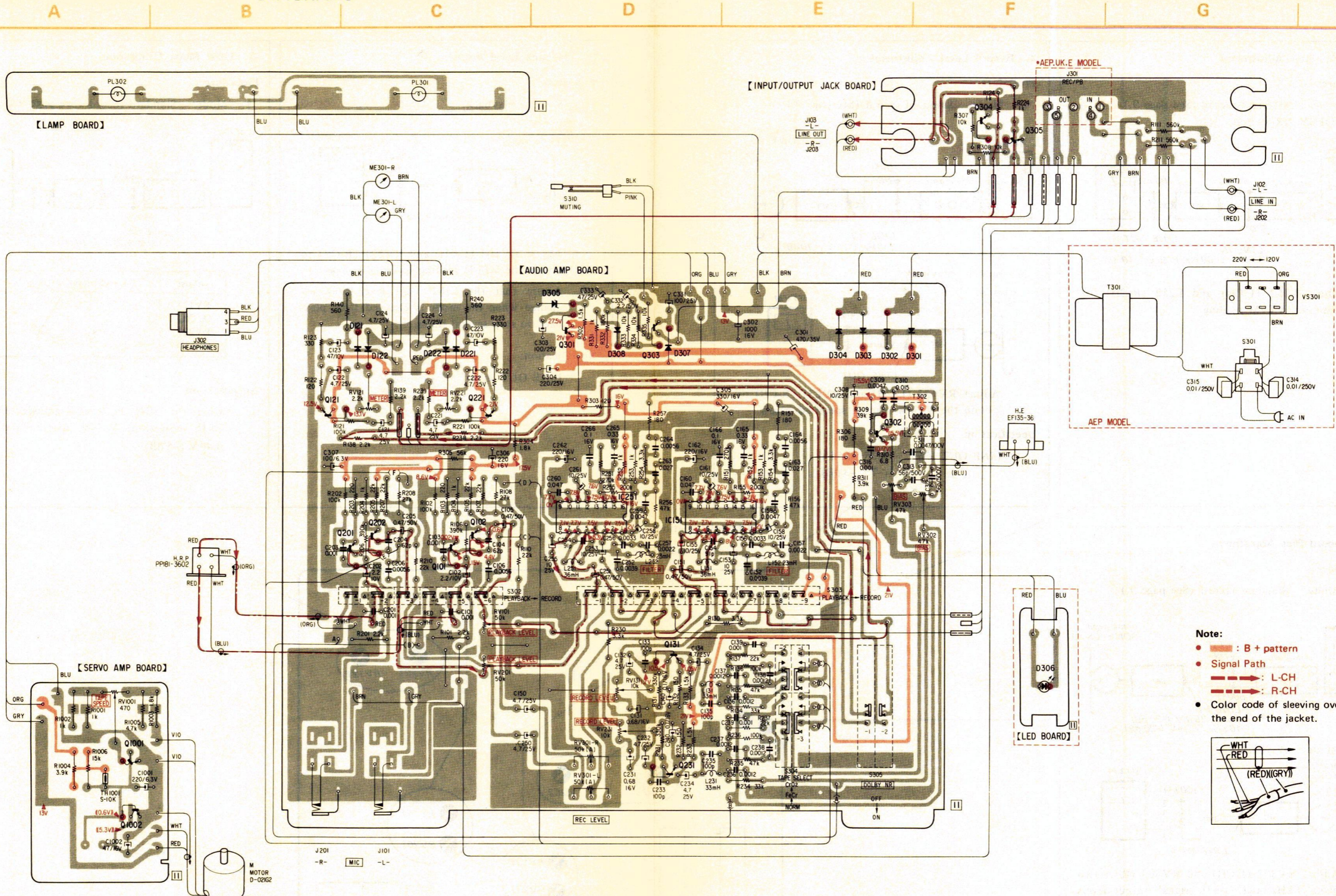

Note:

- : B + pattern
- Signal Path
- L-CH
- R-CH
- Color code of sleeving over the end of the jacket.

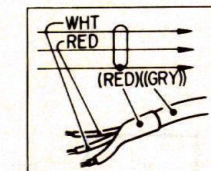

| | | | | | | | | | | | | | | | | |
|---|----|------|------|----------|----------|-----|-----|-------|-----|-----|-------|-----|-----|-----|-----|---|
| Q | IC | 1001 | 1002 | 121 | 202 | 102 | 301 | IC251 | 303 | 131 | IC151 | 302 | 304 | 305 | Q | |
| D | | | | 121, 122 | 222, 221 | | 305 | 308 | 307 | | | 304 | 303 | 302 | 301 | D |
| | | | | | | | | | | | | | | | | |

A B C D E

(4) Note:

- Items with no part number and/or no description are not stocked because they are seldom required for routine service.
- All screws are Phillips (cross recess) type unless otherwise noted.
- (-) = slotted head
- Circled letters (A) to (Z) are applicable to European models only.

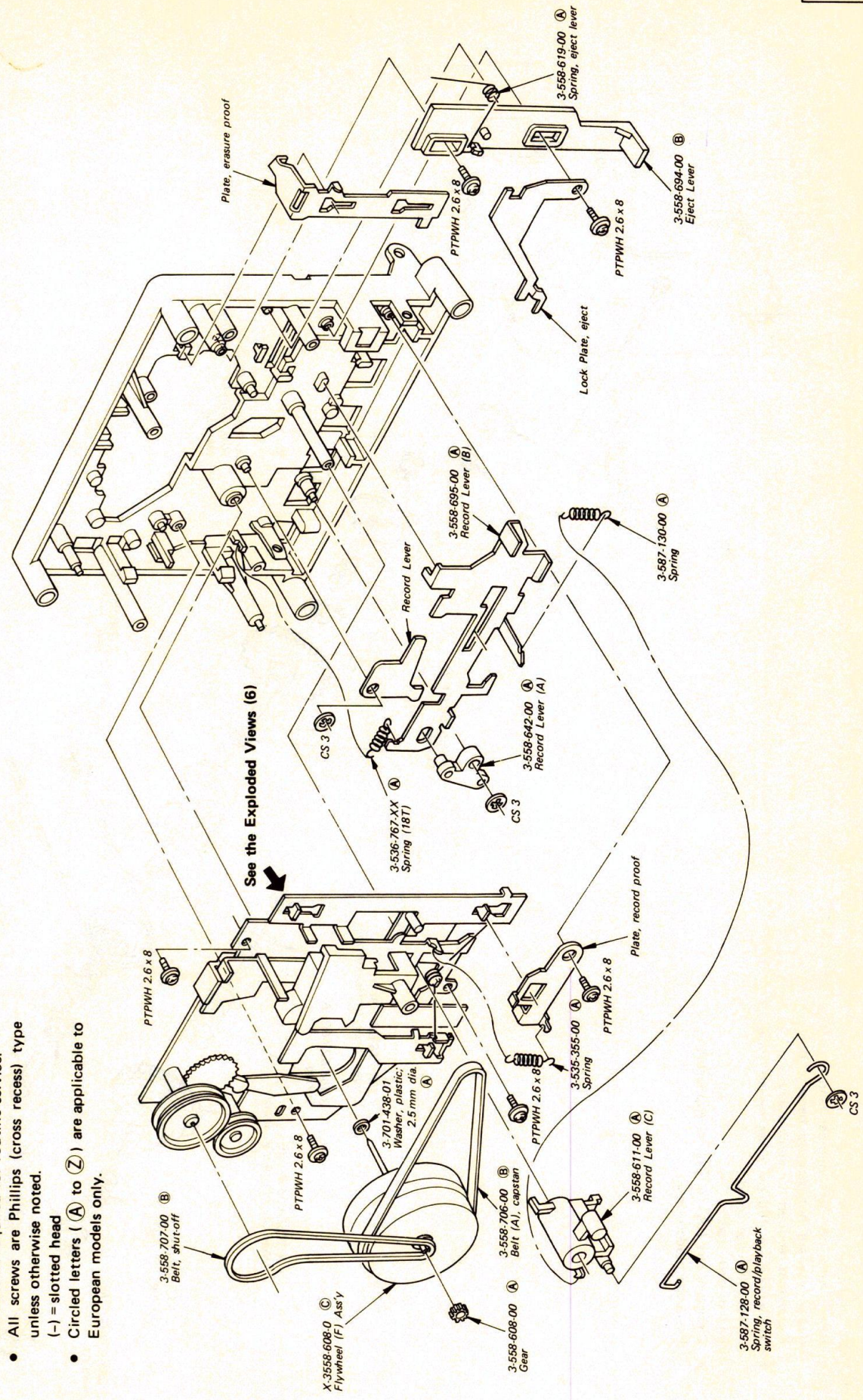

See the Exploded Views (6)

1

2

3

4

A B C D E

(5) Note:

- Items with no part number and/or no description are not stocked because they are seldom required for routine service.
- All screws are Phillips (cross recess) type unless otherwise noted.
- (-) = slotted head
- Circled letters (A) to (Z) are applicable to European models only.

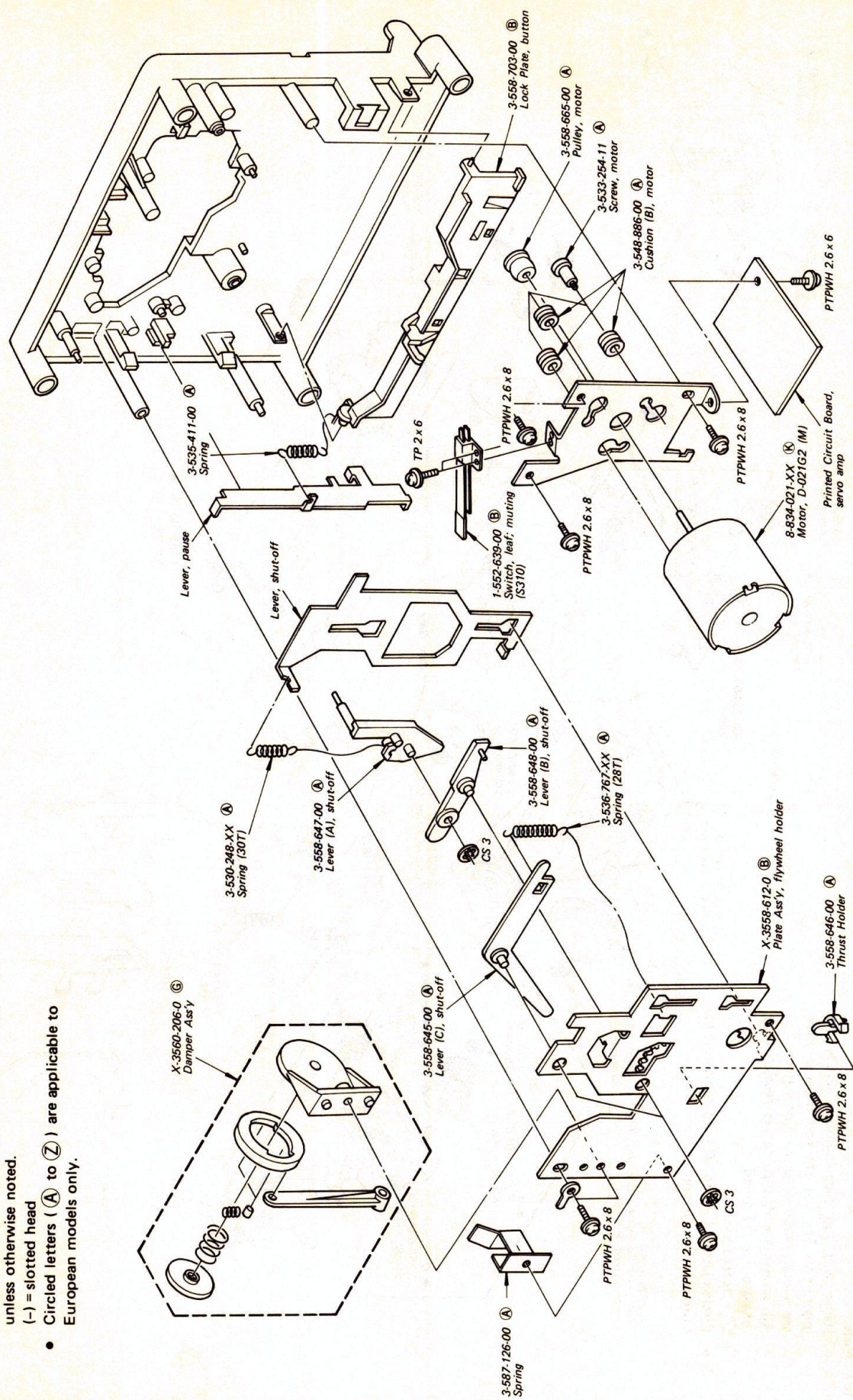

1

2

3

4

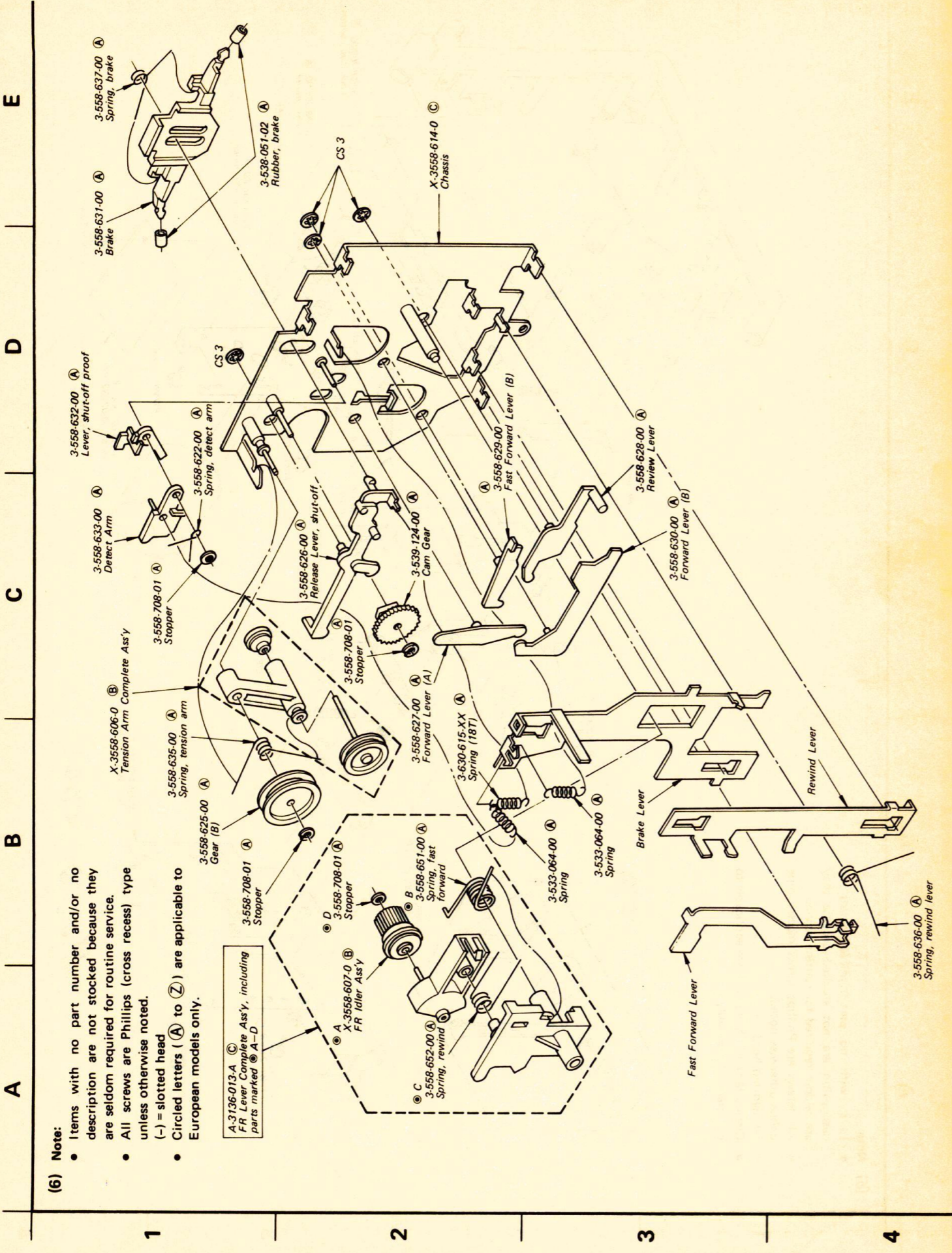

(6) Note:
 • Items with no part number and/or no description are not stocked because they are seldom required for routine service.
 • All screws are Phillips (cross recess) type unless otherwise noted.
 • (-) = slotted head
 • Circled letters (A) to (Z) are applicable to European models only.

A-3735-013-A
 FR Lever Complete Assy, including parts marked A-D

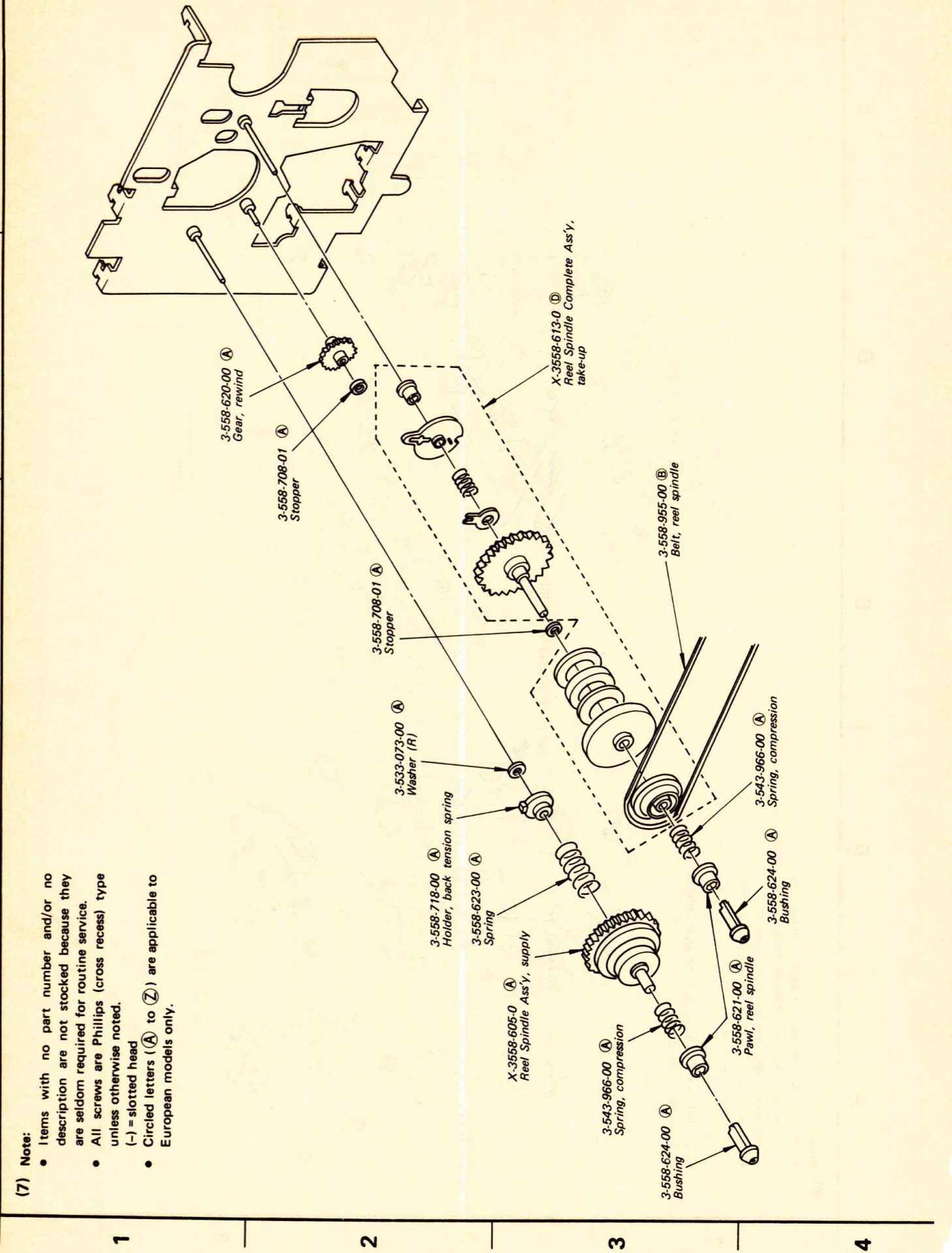

(7) Note:
 • Items with no part number and/or no description are not stocked because they are seldom required for routine service.
 • All screws are Phillips (cross recess) type unless otherwise noted.
 • (-) = slotted head
 • Circled letters (A) to (Z) are applicable to European models only.

SECTION 6
 ELECTRICAL PARTS LIST

Note: Circled letters (A) to (Z) are applicable to European models only.

Note: Circled letters (A) to (Z) are applicable to European models only.

| Ref. No. | Part No. | Description |
|-----------------------|--------------|--------------------------|
| SEMICONDUCTORS | | |
| Transistors | | |
| ⇒ Q101,201 | 8-729-665-47 | (B) 2SC1362 |
| ⇒ Q102,202 | 8-729-663-47 | (B) 2SC1364 |
| Q121,221 | 8-729-100-13 | (B) 2SC2001 |
| ⇒ Q131,231 | 8-729-663-47 | (B) 2SC1364 |
| Q301 | 9-919-380-00 | (C) 2SC1096 |
| ⇒ Q302 | 8-729-663-47 | (B) 2SC1364 |
| ⇒ Q303 | 8-727-788-00 | (B) 2SA678 |
| ⇒ Q304,305 | 8-729-663-47 | (B) 2SC1364 |
| Q1001 | 8-729-663-47 | (B) 2SC1364 |
| Q1002 | 8-729-141-43 | (B) 2SD414 |
| ICs | | |
| IC151,251 | 8-759-906-46 | NE646B |
| Diodes | | |
| ⇒ D121,221 | 8-719-422-21 | (A) 1T22AM |
| ⇒ D122,222 | 8-719-422-21 | (A) 1T22AM |
| ⇒ D301-304 | 8-719-200-02 | (B) 10E2 |
| ⇒ D305 | 8-719-931-22 | (B) EQB01-22 |
| ⇒ D306 | 8-719-301-03 | (B) SEL103R |
| ⇒ D307,308 | 8-719-815-55 | (A) 1S1555 |
| COILS | | |
| L131,231 | 1-408-155-00 | (B) 33 mH, microinductor |
| L151,251 | 1-408-157-00 | (B) 36 mH, microinductor |
| L152,252 | 1-408-156-00 | (B) 23 mH, microinductor |
| TRANSFORMERS | | |
| T301 | 1-446-218-00 | Power (E model) |
| T301 | 1-446-219-00 | Power (UK model) |
| T301 | 1-446-220-00 | Power (Canadian model) |
| T301 | 1-446-221-00 | Power (AEP model) |
| T302 | 1-405-823-00 | Oscillator |

⇒: Due to standardization, interchangeable replacements may be substituted for parts specified in the diagrams.

| Ref. No. | Part No. | Description |
|---|--------------|-----------------------|
| CAPACITORS | | |
| All capacitors are in μF and ceramic unless otherwise noted. 50WV or less are not indicated except for electrolytics and tantalum. p: μF , elect = electrolytic | | |
| C101,201 | 1-102-074-11 | (A) 0.001 |
| C102,202 | 1-131-459-11 | (A) 2.2 10V tantalum |
| C103,203 | 1-102-074-11 | (A) 0.001 |
| C104,204 | 1-101-886-11 | (A) 62p |
| C105,205 | 1-121-726-11 | (A) 0.47 50V elect |
| C106,206 | 1-108-573-12 | (A) 0.0056 mylar |
| C121,221 | 1-121-395-11 | (A) 4.7 25V elect |
| C122,222 | 1-121-395-11 | (A) 4.7 25V elect |
| C123,223 | 1-121-352-11 | (A) 47 10V elect |
| C124,224 | 1-121-395-11 | (A) 4.7 25V elect |
| C131,231 | 1-131-456-11 | (A) 0.68 16V tantalum |
| C132,232 | 1-121-395-11 | (A) 4.7 25V elect |
| C133,233 | 1-102-973-11 | (A) 100p |
| C134,234 | 1-121-395-11 | (A) 4.7 25V elect |
| C135,235 | 1-102-973-11 | (A) 100p |
| C136-138 | 1-108-351-12 | (A) 0.0012 mylar |
| C236-238 | 1-108-351-12 | (A) 0.0012 mylar |
| C139,239 | 1-108-221-12 | (A) 0.001 mylar |
| C140,240 | 1-131-451-11 | (A) 0.1 16V tantalum |
| C150,250 | 1-121-395-11 | (A) 4.7 25V elect |
| C151,251 | 1-121-726-11 | (A) 0.47 50V elect |
| C152,252 | 1-108-354-12 | (A) 0.0039 mylar |
| C153,253 | 1-121-398-11 | (A) 10 25V elect |
| C154,254 | 1-102-972-11 | (A) 91p |
| C155,255 | 1-121-398-11 | (A) 10 25V elect |
| C156,256 | 1-108-232-12 | (A) 0.0033 mylar |
| C157,257 | 1-108-230-12 | (A) 0.0022 mylar |
| C158,258 | 1-121-398-11 | (A) 10 25V elect |
| C159,259 | 1-108-234-12 | (A) 0.0047 mylar |
| C160,260 | 1-108-246-12 | (A) 0.047 mylar |
| C161,261 | 1-121-398-11 | (A) 10 25V elect |
| C162,262 | 1-121-421-11 | (B) 220 16V elect |
| C163,263 | 1-108-359-12 | (A) 0.027 mylar |

Note: Les composants identifiés par un trame et une marque A sont critiques pour la sécurité. Ne les remplacer que par une pièce portant le numéro spécifié.

| Ref. No. | Part No. | Description |
|----------|--------------|---|
| C164,264 | 1-108-355-12 | (A) 0.0056 mylar |
| C165,265 | 1-131-454-11 | (A) 0.33 16V tantalum |
| C166,266 | 1-131-451-11 | (A) 0.1 16V tantalum |
| C301 | 1-121-361-11 | (B) 470 35V elect |
| C302 | 1-121-245-11 | (B) 1000 16V elect |
| C303 | 1-121-416-11 | (B) 100 25V elect |
| C304 | 1-121-422-11 | (B) 220 25V elect |
| C305 | 1-121-521-11 | (B) 330 16V elect |
| C306 | 1-121-421-11 | (B) 220 16V elect |
| C307 | 1-121-413-11 | (A) 100 6.3V elect |
| C308 | 1-121-398-11 | (A) 10 25V elect |
| C309 | 1-108-234-12 | (A) 0.0047 mylar |
| C310 | 1-108-240-12 | (A) 0.015 mylar |
| C311 | 1-108-373-12 | (A) 0.0047 100V mylar |
| C312,313 | 1-107-165-11 | (A) 56p 500V silvered mica |
| C314 | 1-130-151-11 | (B) 0.01 125V (Canadian model) |
| C314,315 | 1-130-196-11 | (D) 0.01 250V polyethylene (AEP, UK, E model) |
| C316 | 1-108-221-12 | (A) 0.001 mylar |
| C331 | 1-121-416-11 | (B) 100 25V elect |
| C332 | 1-121-450-11 | (A) 2.2 50V elect |
| C333 | 1-121-410-11 | (B) 47 25V elect |
| C1001 | 1-121-419-11 | (B) 220 6.3V elect |
| C1002 | 1-121-409-11 | (A) 47 16V elect |

RESISTORS
 All resistors are in ohms. Common 1/4W carbon resistors are omitted. Refer to the list on the last page for their part numbers.

| | | |
|-----------|--------------|--|
| RV101,201 | 1-226-238-00 | (A) 47 k (B), adjustable; playback level |
| RV121,221 | 1-226-234-00 | (A) 2.2 k (B), adjustable; meter |
| RV131,231 | 1-226-236-00 | (A) 10 k (B), adjustable; record level |
| RV301 | 1-226-380-00 | (A) 50 k (A), variable; REC LEVEL |
| RV302,303 | 1-226-238-00 | (A) 47 k (B), adjustable; bias |
| RV1001 | 1-224-641-XX | (B) 470 (B), adjustable; tape speed |

| Ref. No. | Part No. | Description |
|----------------------|--------------|--|
| SWITCHES | | |
| S301 | 1-552-141-12 | (E) Push, POWER (AEP, UK, E model) |
| S301 | 1-552-631-00 | (E) Push, POWER (Canadian model) |
| S302 | 1-552-632-00 | (B) Slide, record/playback |
| S303 | 1-552-634-00 | (B) Slide, record/playback |
| S304 | 1-552-633-00 | (C) Lever-slide, TAPE SELECT |
| S305 | 1-552-635-00 | (C) Lever-slide, DOLBY NR |
| S310 | 1-552-639-00 | (B) Leaf, muting |
| MISCELLANEOUS | | |
| HE | 8-825-506-00 | (C) Head, erase; EF135-36 |
| HRP | 8-829-373-00 | (K) Head, record/playback; PP181-3602 |
| J101,201 | 1-507-554-21 | (C) Jack, MIC |
| J301 | 1-507-618-00 | (A) Connector, REC/PB (AEP, UK, E model) |
| J302 | 1-507-507-00 | (B) Jack, HEADPHONES |
| M | 8-834-021-XX | (K) Motor, D-021G2 |
| ME301 | 1-520-377-00 | (K) Meter, VU |
| PL301,302 | 1-518-351-00 | (B) Lamp, pilot; meter |
| VS301 | 1-552-026-00 | (E) Voltage Selector (E model) |
| VS301 | 1-552-630-00 | (D) Voltage Selector (AEP model) |
| | 1-534-777-00 | (D) Cord, power (UK model) |
| | 1-534-817-XX | (E) Cord, power (AEP model) |
| | 1-534-986-XX | (E) Cord, power; parallel blade plug (Canadian, E model) |
| | 1-551-530-11 | (E) Cord, power; euro-plug (E model) |
| | 1-551-629-00 | (C) Cord with Plug |

Power Cord - Euro-plug (1-551-530-11)

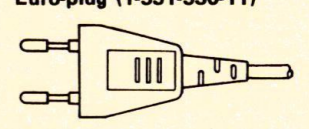

Parallel-blade plug (1-534-986-XX)



Note: The components identified by shading and mark A are critical for safety. Replace only with part number specified.

Note: The components identified by shading and mark A are critical for safety. Replace only with part number specified.

Note: Les composants identifiés par un trame et une marque A sont critiques pour la sécurité. Ne les remplacer que par une pièce portant le numéro spécifié.

Note: Circled letters (A to Z) are applicable to European models only.

1/4 WATT CARBON RESISTORS (A)

Note: Circled letter (A) is applicable to European models only.

ACCESSORIES & PACKING MATERIALS

| Part No. | Description |
|--------------|-------------------------------|
| X-3701-105-0 | (A) Tips Ass'y, head cleaning |
| 3-587-101-00 | (B) Cushion |
| 3-587-112-00 | Carton (Canadian model) |
| 3-587-113-00 | (D) Carton (AEP, UK, E model) |
| 3-701-630-00 | (A) Bag, polyethylene |
| 3-770-562-11 | (D) Manual, instruction |
| 4-855-809-00 | (B) Bag, polyethylene |

| Ω | Part No. | Ω | Part No. | Ω | Part No. | Ω | Part No. | Ω | Part No. | Ω | Part No. | Ω | Part No. |
|-----|--------------|----|--------------|-----|--------------|------|--------------|-----|--------------|------|--------------|------|--------------|
| 1.0 | 1-244-601-11 | 10 | 1-244-625-11 | 100 | 1-244-649-11 | 1.0k | 1-244-673-11 | 10k | 1-244-697-11 | 100k | 1-244-721-11 | 1.0M | 1-244-745-11 |
| 1.1 | 1-244-602-11 | 11 | 1-244-626-11 | 110 | 1-244-650-11 | 1.1k | 1-244-674-11 | 11k | 1-244-698-11 | 110k | 1-244-722-11 | 1.1M | 1-244-746-11 |
| 1.2 | 1-244-603-11 | 12 | 1-244-627-11 | 120 | 1-244-651-11 | 1.2k | 1-244-675-11 | 12k | 1-244-699-11 | 120k | 1-244-723-11 | 1.2M | 1-244-747-11 |
| 1.3 | 1-244-604-11 | 13 | 1-244-628-11 | 130 | 1-244-652-11 | 1.3k | 1-244-676-11 | 13k | 1-244-700-11 | 130k | 1-244-724-11 | 1.3M | 1-244-748-11 |
| 1.5 | 1-244-605-11 | 15 | 1-244-629-11 | 150 | 1-244-653-11 | 1.5k | 1-244-677-11 | 15k | 1-244-701-11 | 150k | 1-244-725-11 | 1.5M | 1-244-749-11 |
| 1.6 | 1-244-606-11 | 16 | 1-244-630-11 | 160 | 1-244-654-11 | 1.6k | 1-244-678-11 | 16k | 1-244-702-11 | 160k | 1-244-726-11 | 1.6M | 1-244-750-11 |
| 1.8 | 1-244-607-11 | 18 | 1-244-631-11 | 180 | 1-244-655-11 | 1.8k | 1-244-679-11 | 18k | 1-244-703-11 | 180k | 1-244-727-11 | 1.8M | 1-244-751-11 |
| 2.0 | 1-244-608-11 | 20 | 1-244-632-11 | 200 | 1-244-656-11 | 2.0k | 1-244-680-11 | 20k | 1-244-704-11 | 200k | 1-244-728-11 | 2.0M | 1-244-752-11 |
| 2.2 | 1-244-609-11 | 22 | 1-244-633-11 | 220 | 1-244-657-11 | 2.2k | 1-244-681-11 | 22k | 1-244-705-11 | 220k | 1-244-729-11 | 2.2M | 1-244-753-11 |
| 2.4 | 1-244-610-11 | 24 | 1-244-634-11 | 240 | 1-244-658-11 | 2.4k | 1-244-682-11 | 24k | 1-244-706-11 | 240k | 1-244-730-11 | 2.4M | 1-244-754-11 |
| 2.7 | 1-244-611-11 | 27 | 1-244-635-11 | 270 | 1-244-659-11 | 2.7k | 1-244-683-11 | 27k | 1-244-707-11 | 270k | 1-244-731-11 | 2.7M | 1-244-755-11 |
| 3.0 | 1-244-612-11 | 30 | 1-244-636-11 | 300 | 1-244-660-11 | 3.0k | 1-244-684-11 | 30k | 1-244-708-11 | 300k | 1-244-732-11 | 3.0M | 1-244-756-11 |
| 3.3 | 1-244-613-11 | 33 | 1-244-637-11 | 330 | 1-244-661-11 | 3.3k | 1-244-685-11 | 33k | 1-244-709-11 | 330k | 1-244-733-11 | 3.3M | 1-244-757-11 |
| 3.6 | 1-244-614-11 | 36 | 1-244-638-11 | 360 | 1-244-662-11 | 3.6k | 1-244-686-11 | 36k | 1-244-710-11 | 360k | 1-244-734-11 | 3.6M | 1-244-758-11 |
| 3.9 | 1-244-615-11 | 39 | 1-244-639-11 | 390 | 1-244-663-11 | 3.9k | 1-244-687-11 | 39k | 1-244-711-11 | 390k | 1-244-735-11 | 3.9M | 1-244-759-11 |
| 4.3 | 1-244-616-11 | 43 | 1-244-640-11 | 430 | 1-244-664-11 | 4.3k | 1-244-688-11 | 43k | 1-244-712-11 | 430k | 1-244-736-11 | 4.3M | 1-244-760-11 |
| 4.7 | 1-244-617-11 | 47 | 1-244-641-11 | 470 | 1-244-665-11 | 4.7k | 1-244-689-11 | 47k | 1-244-713-11 | 470k | 1-244-737-11 | 4.7M | 1-244-761-11 |
| 5.1 | 1-244-618-11 | 51 | 1-244-642-11 | 510 | 1-244-666-11 | 5.1k | 1-244-690-11 | 51k | 1-244-714-11 | 510k | 1-244-738-11 | 5.1M | 1-244-762-11 |
| 5.6 | 1-244-619-11 | 56 | 1-244-643-11 | 560 | 1-244-667-11 | 5.6k | 1-244-691-11 | 56k | 1-244-715-11 | 560k | 1-244-739-11 | | |
| 6.2 | 1-244-620-11 | 62 | 1-244-644-11 | 620 | 1-244-668-11 | 6.2k | 1-244-692-11 | 62k | 1-244-716-11 | 620k | 1-244-740-11 | | |
| 6.8 | 1-244-621-11 | 68 | 1-244-645-11 | 680 | 1-244-669-11 | 6.8k | 1-244-693-11 | 68k | 1-244-717-11 | 680k | 1-244-741-11 | | |
| 7.5 | 1-244-622-11 | 75 | 1-244-646-11 | 750 | 1-244-670-11 | 7.5k | 1-244-694-11 | 75k | 1-244-718-11 | 750k | 1-244-742-11 | | |
| 8.2 | 1-244-623-11 | 82 | 1-244-647-11 | 820 | 1-244-671-11 | 8.2k | 1-244-695-11 | 82k | 1-244-719-11 | 820k | 1-244-743-11 | | |
| 9.1 | 1-244-624-11 | 91 | 1-244-648-11 | 910 | 1-244-672-11 | 9.1k | 1-244-696-11 | 91k | 1-244-720-11 | 910k | 1-244-744-11 | | |

HARDWARE NOMENCLATURE

Screw:

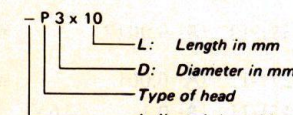

Unless otherwise indicated, it means cross-recessed head (Phillips type).

Nut, Washer, Retaining ring:

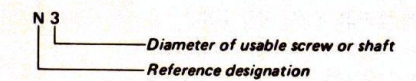

| Reference Designation | Shape | Description | Remarks |
|-----------------------|-------|---|--|
| SCREWS | | | |
| P | | pan-head screw | binding-head (B) screw for replacement |
| PWH | | pan-head screw with washer face | binding-head (B) screw and flat washer for replacement |
| PS PSP | | pan-head screw with spring washer | binding-head (B) screw and spring washer for replacement |
| PSW PSPW | | pan-head screw with spring and flat washers | binding-head (B) screw and spring and flat washers for replacement |
| R | | round-head screw | binding-head (B) screw for replacement |
| K | | flat-countersunk-head screw | |
| RK | | oval-countersunk-head screw | |
| B | | binding-head screw | |
| T | | truss-head screw | binding-head (B) screw for replacement |
| F | | flat-fillister-head screw | |
| RF | | fillister-head screw | |
| BV | | braizer-head screw | |

| Reference Designation | Shape | Description | Remarks |
|----------------------------|-------|--|---|
| SELF-TAPPING SCREWS | | | |
| TA | | self-tapping screw | ex: TA, P 3 x 10 |
| PTP | | pan-head self-tapping screw | binding-head self-tapping (TA, B) screw for replacement |
| PTPWH | | pan-head self-tapping screw with washer face | binding-head self-tapping (TA, B) screw and flat washer for replacement |
| PTTWH | | pan-head thread-rolling screw with washer face | binding-head (B) screw and flat washer for replacement |
| SET SCREWS | | | |
| SC | | set screw | |
| SC | | hexagon-socket set screw | ex: SC 2.6 x 4, hexagon socket |
| NUT | | | |
| N | | nut | |
| WASHERS | | | |
| W | | flat washer | |
| SW | | spring washer | |
| LW | | internal-tooth lock washer | ex: LW3, internal |
| LW | | external-tooth lock washer | ex: LW3, external |
| RETAINING RINGS | | | |
| E | | retaining ring | |
| G | | grip-type retaining ring | |

Sony Corporation

© 1978

— 28 —