

The home of the turntable

# THE VINYL **ENGINE**®

For more turntable manuals and setup information  
please visit [www.vinylengine.com](http://www.vinylengine.com)



**Technics**  
by Panasonic

**QUARTZ**  
**SL-1300MK2**

Quartz-Phase-Locked Control  
Direct Drive Fully-Automatic Turntable  
with Quartz Synthesizer Pitch Control



*Professional Series*





# SL-1300MK2

The Accuracy of Quartz Controlled Direct Drive  
Now Extends to User-Selected Pitch Adjustments,  
with  $\pm 9.9\%$  Adjustment Range

The SL-1300MK2 has wow & flutter of only 0.025% WRMS. That's low. But turntables have not always had this kind of rotational accuracy. In fact, most record albums are cut to a lower degree of precision. Back some eight years ago, Technics introduced the turntable that opened up the possibility of performance on this level. That turntable was the first direct drive to be introduced. And since that breakthrough, we at Technics have been working to improve on the basic direct drive concept. In 1976, Technics' SP-10MKII added quartz control to a turntable that was already legendary among audiophiles, and achieved even better speed accuracy ( $\pm 0.002\%$ ), along with enormous torque and super-fast start/stop action. Now, we are proud to introduce the SL-1300MK2, which extends quartz control to user-selected pitch changes within a range of  $\pm 9.9\%$  of the standard speed (33 $\frac{1}{3}$  or 45 rpm). Unlike quartz turntables of the past, in which quartz control had to be disengaged if pitch were altered, the SL-1300MK2 uses a quartz synthesizer to retain  $\pm 0.002\%$  speed accuracy in the pitch-altered mode. And so you know exactly how fast the turntable is turning, the programmable synthesizer gives you a constant digital readout of the percentage difference from the standard speed.

## Total Quartz Phase-Locked Control at 199 Speed Increments and Digital LED Pitch Readout Controlled by Quartz Synthesizer

By now most people have heard of quartz watches. The same quartz controlled split-second accuracy is used in Technics' Quartz synthesizer direct drive turntables to attain a maximum of only 0.002% deviation from perfect rotational speed. With the SL-1300MK2, speed is adjustable. So you can raise or lower the pitch on your records to achieve a sound that may be more pleasing to you, or to match the pitch of an instrument to be played along with the record. And precise "stretching" or "shrinking" of running time to meet fixed time intervals, as in broadcast work, can be established without guesswork. No matter what speed you

choose, the same incredible rotational accuracy is maintained. Because the quartz synthesizer is used to control *all* speeds, not just the standard 33 $\frac{1}{3}$  or 45 rpm.

Operation is simple. Just press the plus or minus feather-touch button and speed will increase or decrease by 0.1%. Keep the button depressed and the pitch change will continue up to 9.9%. That means a total of 199 different speed settings are possible. The LED display to the left of the pitch control buttons gives a readout of the pitch variation that you have chosen. Starting from 33 $\frac{1}{3}$ , for instance, the display will show "+0.1%" after you've pressed the plus button once. An indication of plus 5.9% or minus 5.6% means that the musical pitch has been raised or lowered by one half note. All electronic controls and the LED digital display are out front for easy use even when the dust cover is down.

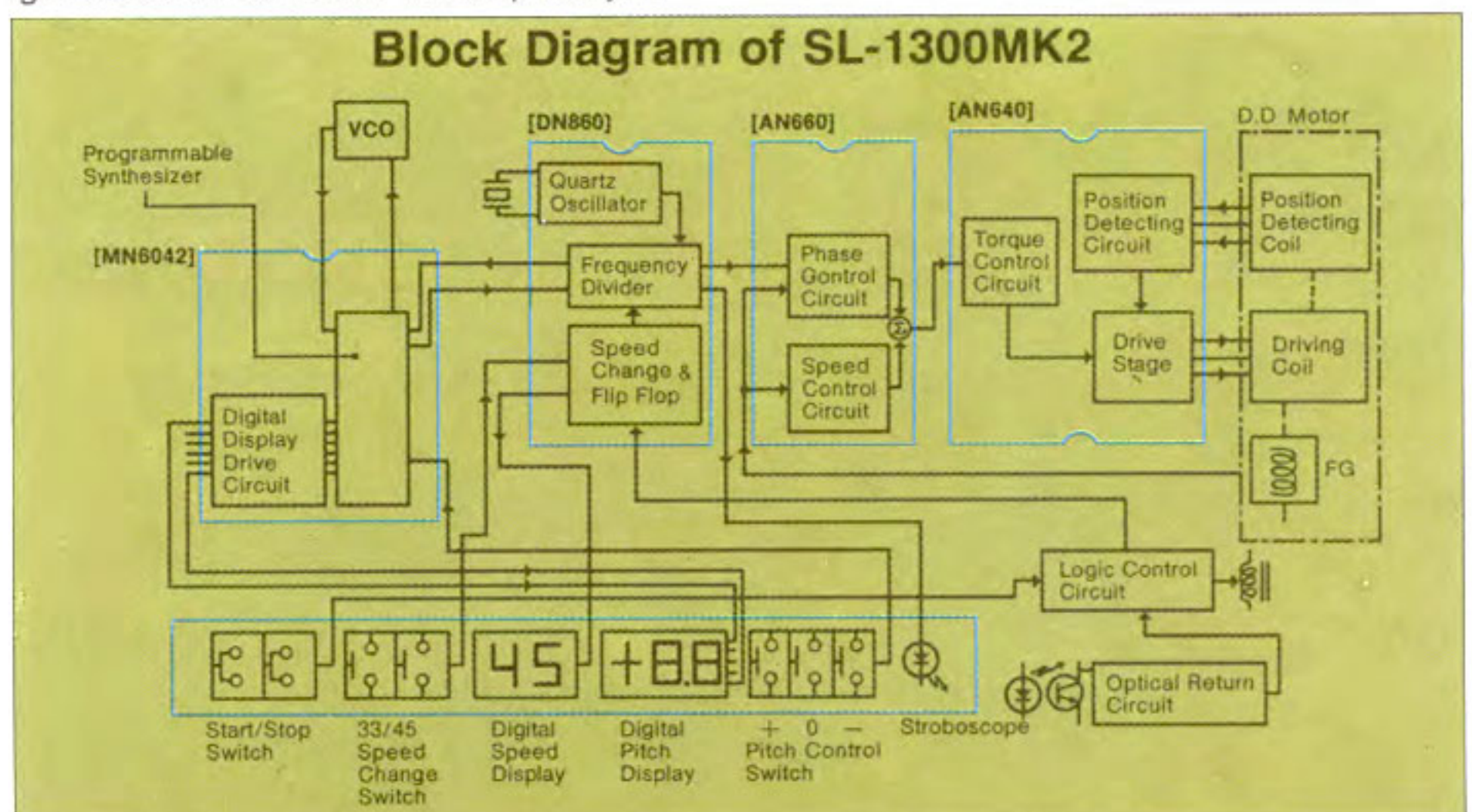





### All Control Functions Effected by High-Density ICs

The SL-1300MK2 has such a sleek functional design and such ease of operation that one may forget the technological and engineering complexity upon which it is based. High-density integrated circuits are used to squeeze the operations of more than 3000 discrete elements into a few inches of space. The IC's used cover these basic functions: quartz-synthesizer pitch control and digital driver, quartz oscillator frequency divider and speed change control, phase and speed control, and full-cycle, integration-type frequency generator. Furthermore, automatic operation is based on our most advanced detection and logic circuits.

### All Front Controls

Technics designs equipment for excellent musical reproduction. But we never forget that equipment is operated by people. So we put the control buttons and LED display in-line on the front panel for optimum handling convenience. The control buttons have a 0.4 mm stroke and take 90 grams of pressure to operate the circuits. This allows precision control capability without the annoyance of accidental operation.

### Double Isolated Suspension System and Special Base Material Reduces Acoustic Feedback Problems

Acoustic feedback is a serious threat to turntable performance. Technics developed the double isolated system to cut feedback down to virtually zero. The aluminum diecast turntable base is supported by one set of isolators. The inner main base is made of a newly developed anti-resonant heavy material molded from fiberglass and other inorganic materials, and is suspended from the turntable base by a second set of isolators. The all-important turntable, motor and tonearm assemblies are mounted on this main base. This construction minimizes the sound-degrading effects of feedback.

### Sensitive Gimbal Suspension Tonearm

20 miniature balls in bearings finished to a tolerance of  $\pm 0.5\%$  microns reduce friction and improve response. The arm is so sensitive that it will respond to forces as tiny as 7 mg. So you can expect to get all the performance your high compliance cartridge is designed to give.

### Fully Automatic Tonearm Function and Output Muting

You'll find that in automatic operation the tonearm is so quiet that you have to see it to know it's moving. Technics uses mechanically silent, precision molded, hard synthetic parts in the tonearm control mechanism. An optical sensor detects the record's end and activates the auto-return system. The result is clean, noise-free operation. And it's all controlled by advanced integrated circuit logic. An automatic muting circuit cuts off the irritating noise when the needle is set down on or lifted up from the record. This output muting is also effective when the cueing lever is used for manual operation.

### Memo-Repeat

This convenient feature lets you decide how many times you want the record played automatically. The control may be set for repeat playing up to six times or it may be set to continue playing the record an indefinite number of times.

### S/N ratio 73 dB (DIN 45539B) Wow & Flutter 0.025% (WRMS)

There is no point going into detail about these figures except to point out that they are better than the standards to which your record albums are made.

### Integral Rotor Platter Motor

A refinement of the basic direct drive idea, the integral rotor platter merely combines the turntable platter with the rotor of the motor. The number of parts is reduced and performance is improved as evidenced by the low wow and flutter achieved.



MN6042 Equivalent to 1856 elements

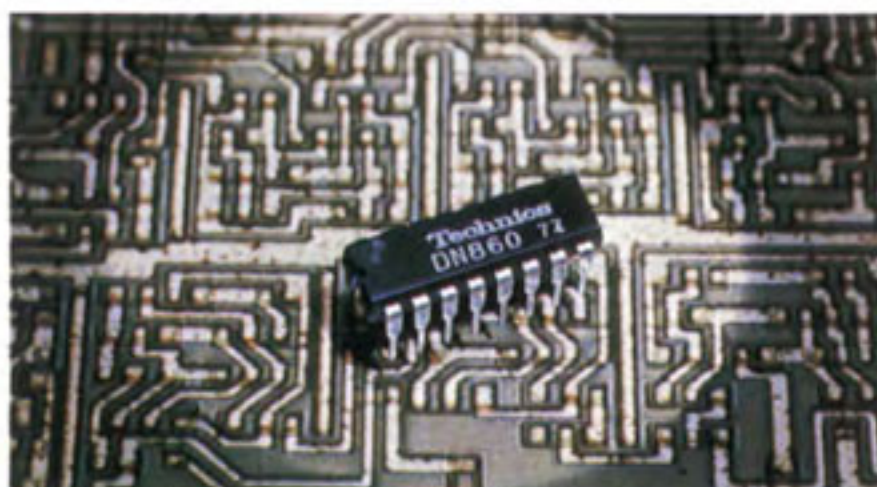

DN860 Equivalent to 380 elements



AN660 Equivalent to 427 elements



AN640 Equivalent to 340 elements

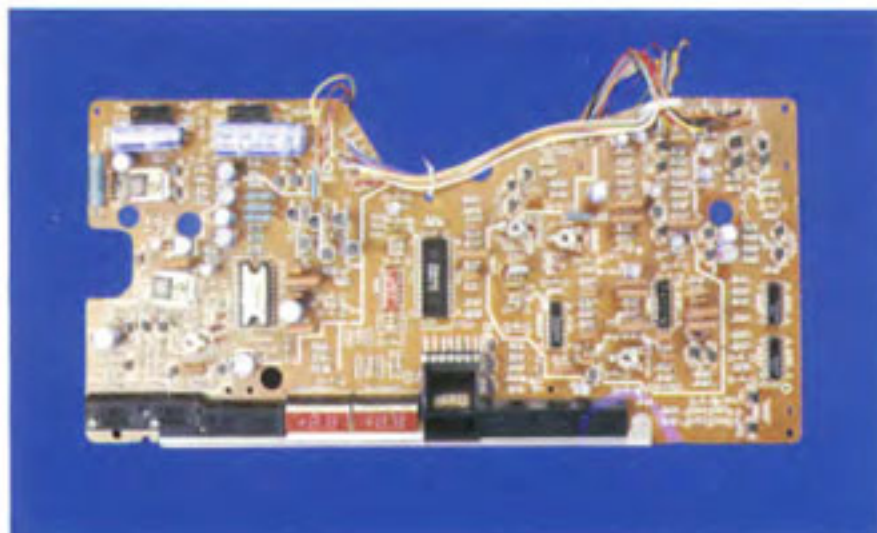





### High Torque for Fast Starts, Steady Speed

The integral rotor platter motor delivers 1.3 lb·in (1.5 kg·cm) torque to virtually eliminate the speed fluctuations caused by tonearm or record cleaner drag. In fact, if you could fit 150 tonearms tracking 2 grams each onto this turntable, it would still rotate at precisely the chosen speed. But in more realistic terms, this enormous torque gives very quick starts. From standstill, the platter reaches 33-1/3 rpm within 0.7 sec. (a quarter of a turn). This is a big advantage in many professional applications where nearly instant cueing is a necessity. Quick braking is achieved with a fully electronic system.

### Other Features

- Arm height is adjustable within a range of 6 mm to accommodate varying cartridge dimensions.
- Zinc diecast heavy tonearm base for improved acoustic characteristics.
- Resonance dampened head shell with unique overhang adjuster.
- Low capacitance phonocables.

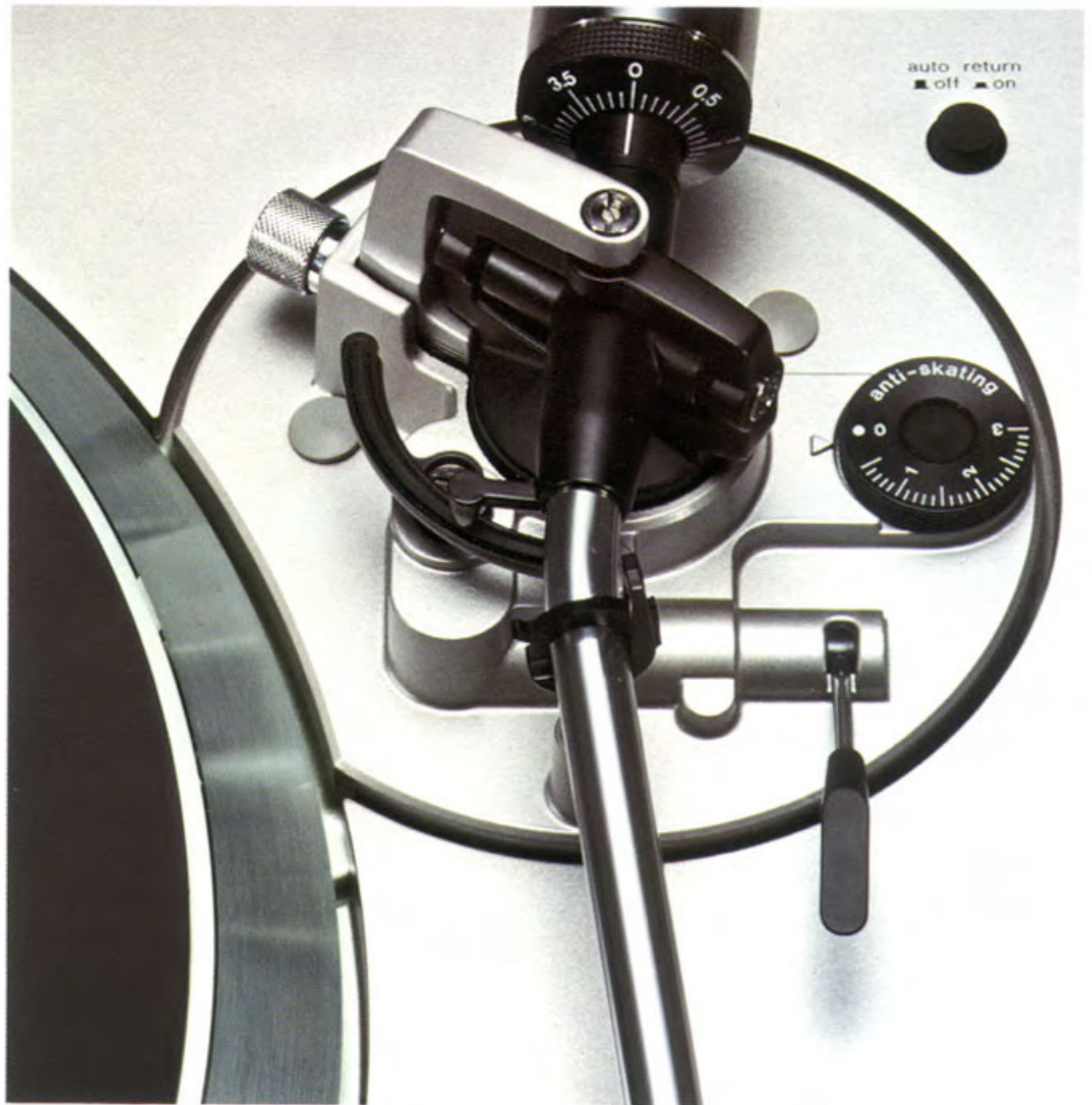

### Cross Section of Technics Quartz Series

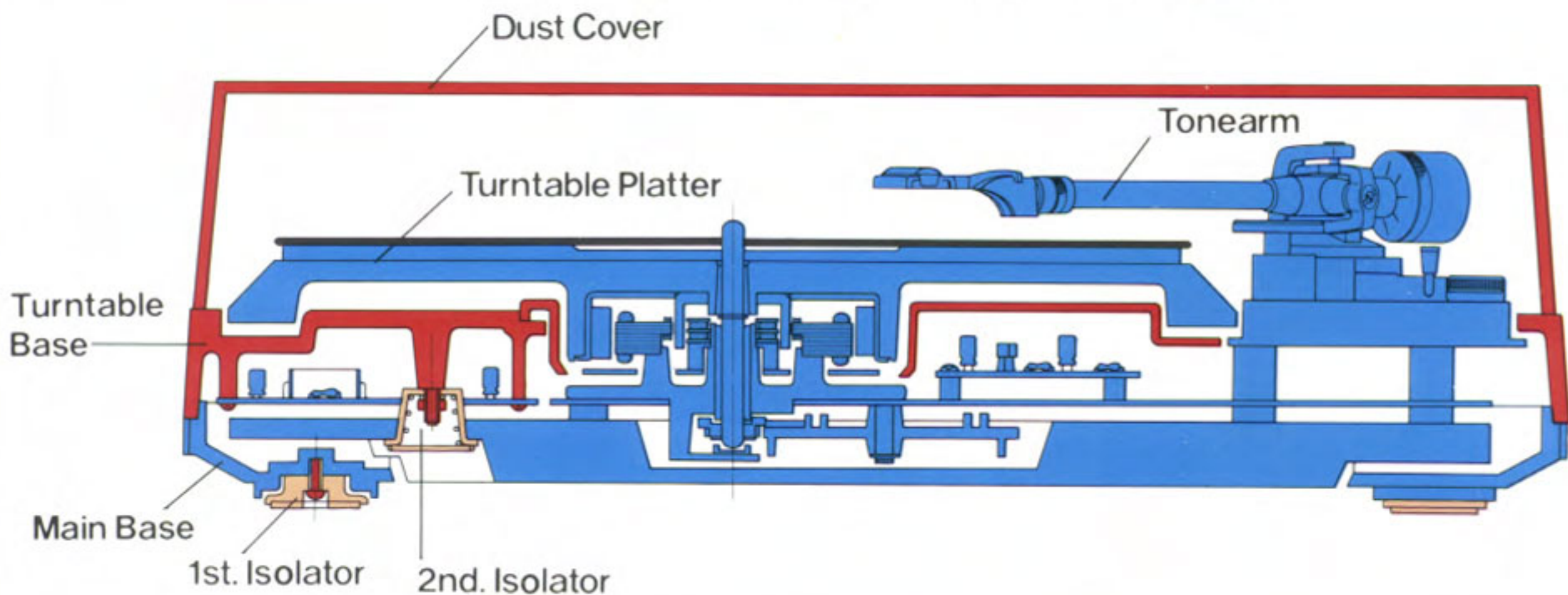



# Functional Beauty and Human Engineering

At Technics, we begin with vast resources in material and technical know-how. By striving for the ultimate in performance, while at the same time simplifying design, we have established a strong reputation for leadership in the competitive turntable industry. At the same time, we design

our products with the user in mind, incorporating features that contribute both to performance and ease of operation. Spin a disc on the SL-1300MK2, and find out how good a turntable can be.





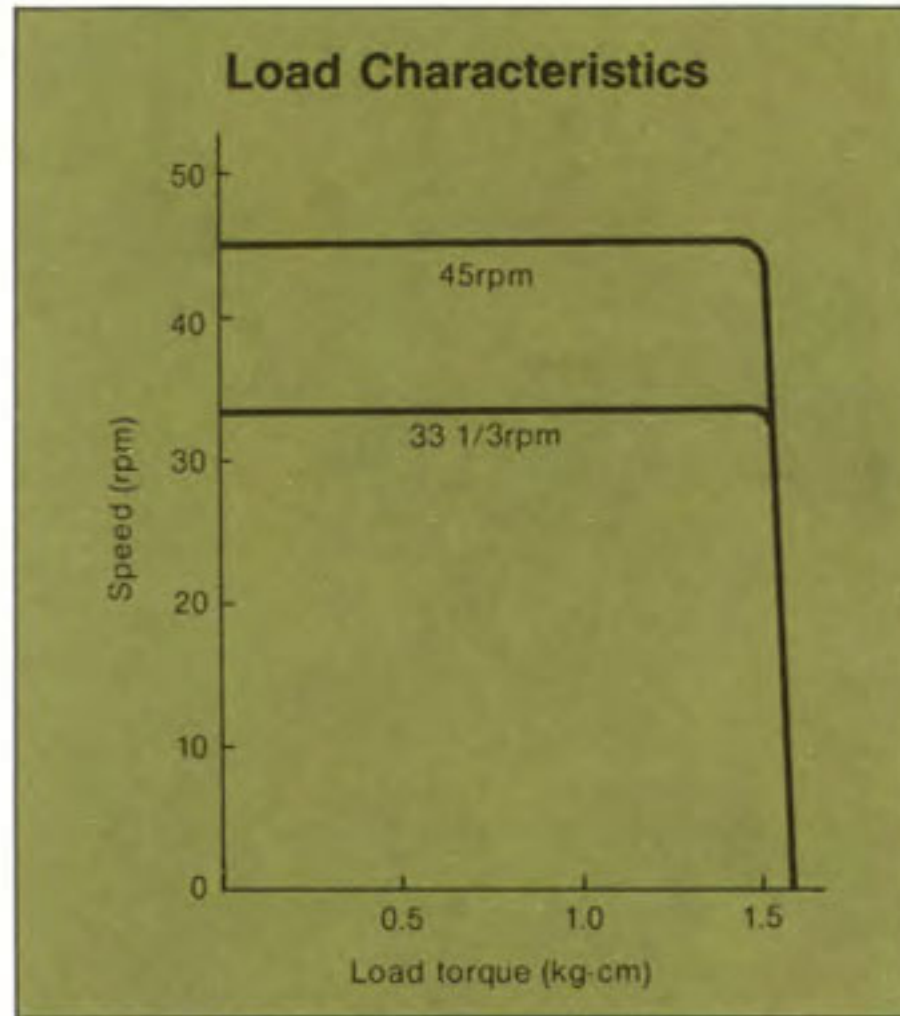
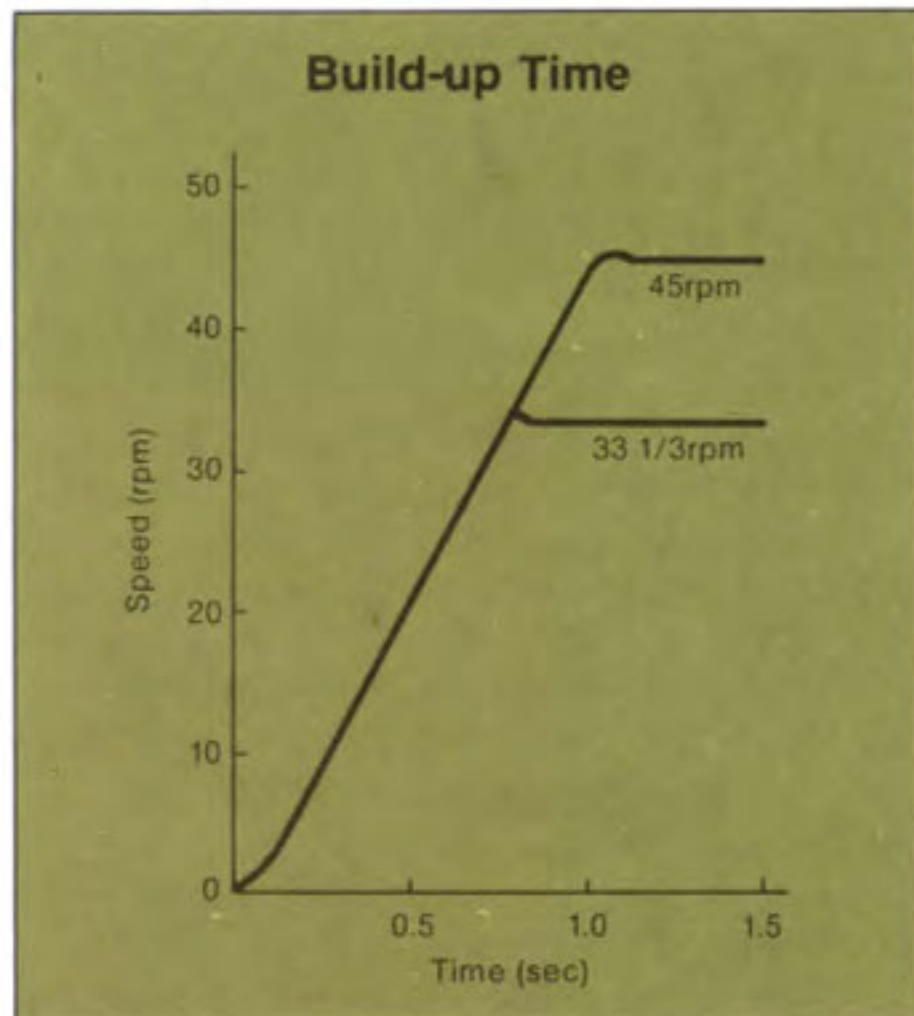
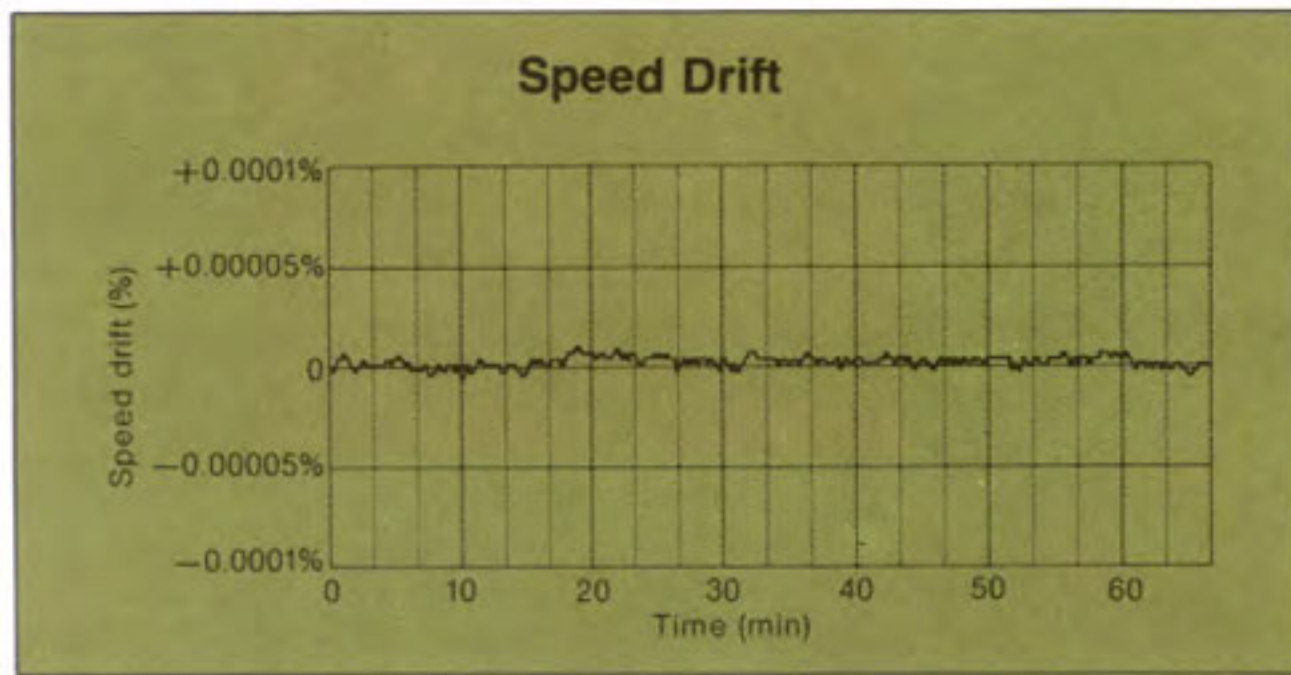

# Technical Specifications

## TURNTABLE SECTION

Type	Quartz-phase-locked control direct drive fully-automatic turntable
Motor	Ultra-low-speed brushless DC motor
Turntable platter	Aluminum diecast, diameter 13" (33 cm), weight 5.5 lb. (2.5 kg) moment of inertia 116 lb-in <sup>2</sup> (340 kg-cm <sup>2</sup> )
Turntable speeds	33 1/3 and 45 rpm
Pitch controls	Quartz synthesizer pitch control ±9.9% range digital pitch readout
Starting torque	1.3 lb-in (1.5 kg-cm)
Speed fluctuation due to load torque	0% within 1.3 lb-in (1.5 kg-cm)
Speed drift	Within ±0.002%
Wow and flutter	0.025% WRMS (JIS C5521) ±0.035% weighted zero to peak (DIN 45507)
Rumble	-50 dB (DIN 45539A) -73 dB (DIN 45539B)

## ONEARM SECTION

Type	Universal "S" shaped tubular arm, static-balanced type, with anti-skating force control device, oil-damped cueing device in both directions
Effective length	9-1/16" (230 mm)
Overhang	19/32" (15 mm)
Tracking error angle	+1° at the inner groove of record +3° at the outer groove of record
Friction	7 mg (lateral, vertical)
Effective mass	22 g (with a cartridge weighing 6.5 g at 1.25 g tracking force)
Offset angle	21.5°
Tonearm height adjustment	6 mm
Adjustable tracking force	0~3 g
Headshell weight	9.5 g
Cartridge weight range	5~11 g

## GENERAL

Power consumption	12 W
Power supply	AC 120 V, 50/60 Hz
Dimensions (H×W×D)	5-45/64" × 17-45/64" × 15-7/64" (14.5×45.3×38.4 cm)
Weight	26.0 lb. (11.8 kg)

## Quartz Synthesizer Pitch Control Series Also Feature:

SL-1400MK2 The Semi-Automatic



SL-1500MK2 The Manual



**Technics**  
by Panasonic

Panasonic Company

Division of Matsushita Electric Corporation of America

EXECUTIVE OFFICES: One Panasonic Way, Secaucus, New Jersey 07094 (201) 348-7000

PANASONIC NEW YORK: 50 Meadowlands Parkway, Secaucus, New Jersey 07094 (201) 348-7000

PANASONIC NEW JERSEY: 50 Meadowlands Parkway, Secaucus, New Jersey 07094 (201) 348-7000

PANASONIC BOSTON: C.C. & F. Industrial Park, 31 Suffolk Road, Mansfield, Mass. 02048 (617) 339-9115

PANASONIC BALTIMORE: 11 Azar Court, Baltimore, Md. 21227 (301) 247-4300

PANASONIC CHICAGO: 363 N. Third Avenue, Des Plaines, Ill. 60016 (312) 299-7171

PANASONIC ATLANTA: 1 Meca Way, Duluth, Georgia 30136 (404) 448-1100

PANASONIC DALLAS: 1825 Walnut Hill Lane, Irving, Texas 75062 (214) 258-2828

NEWCRAFT, INC.: 8383 Wilshire Blvd., Beverly Hills, Calif. 90211 (213) 655-5160

PANASONIC SALES COMPANY: Ave. 65 de Infanteria, Km. 9.7, Victoria Industrial Park, Carolina, Puerto Rico 00630 (809) 769-4320

MATSUSHITA ELECTRIC OF HAWAII, INC.: 320 Waiakamilo Road, Honolulu, Hawaii 96817 (808) 847-5361