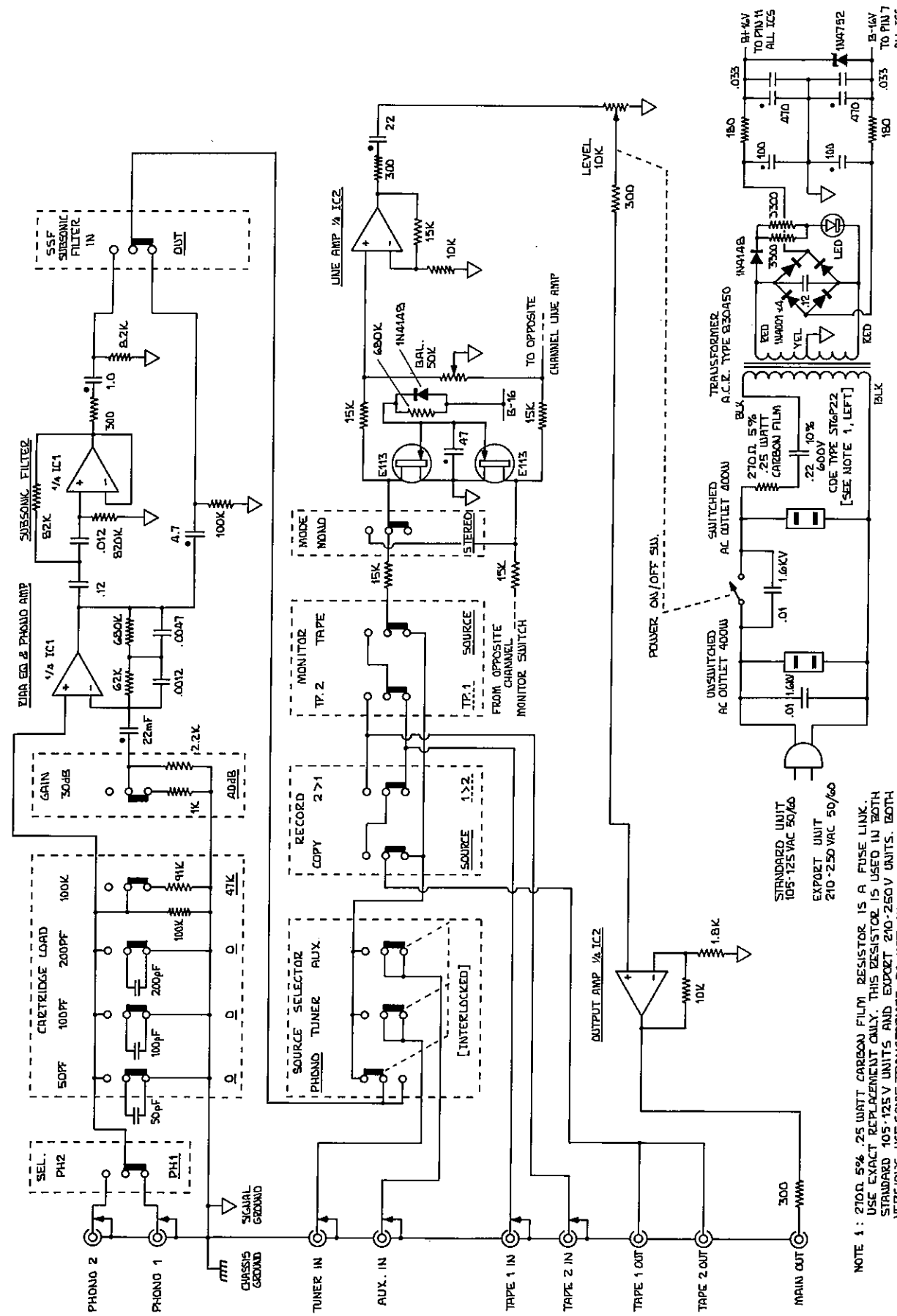

TABLE OF CONTENTS

WARRANTY STATEMENT.....	Page 2
PURCHASE RECORD.....	Page 3
AFTER UNPACKING.....	Page 4
INTRODUCTION.....	Page 5
FRONT PANEL CONTROLS.....	Page 6
REAR PANEL CONNECTIONS.....	Page 7
INSTALLATION.....	Page 8
PHONO STAGE CONTROLS.....	Page 9
SETTING UP FOR YOUR CARTRIDGE.....	Page 12
30dB/40dB SWITCH.....	Page 14
SUBSONIC FILTER (SSF).....	Page 14
PHONO 1 / PHONO 2 SWITCH.....	Page 14
FUNCTION SWITCH.....	Page 15
FUNCTION IMPLEMENTATION DIAGRAMS.....	Pages 16 & 17
GRAPHIC EQUALIZER (Spectro Acoustics Model 210) ADD-ON.....	Page 18
MAINTENANCE AND REPAIR.....	Page 20
SPECIFICATIONS.....	Page 21
SCHEMATIC DIAGRAM.....	Page 23



SPECTRO ACOUSTICS

MODEL 217 STRAIGHTLINE PREAMP
 AUG. & DESIGN 5-76 B.T. MORRISON

NOTE 1 : 270Ω 5% .25 WATT CARBON FILM RESISTOR IS A FUSE LINK. USE EXACT REPLACEMENT ONLY. THIS RESISTOR IS USED IN BOTH STANDARD 105-125V UNITS AND EXPORT 240-250V UNITS. BOTH VERSIONS USE SAME TRANSFORMER-DO NOT SUBSTITUTE IT. THE .22μF CAPACITOR IS AN AC CURRENT-LIMITING DEVICE USED ONLY IN 240-250 V UNITS. THIS IS A SPECIAL UL APPROVED TYPE-DO NOT SUBSTITUTE TO CONVERT 240-250V UNIT TO 105-125V UNIT REMOVE THIS CAPACITOR AND WIRE-BRIDGE THE TERMINALS.

NOTE 2 : ALL IC'S TYPE 4736 EXCEPT FRIBCHILD ~ ALL RESISTORS ARE .5WATT 5% UNLESS NOTED OTHERWISE. ALL CAPACITORS GIVEN IN MFD UNLESS NOTED ~ ONE CHANNEL ONLY IS SHOWN HERE.

WARNING
 To prevent fire or shock hazard, do not expose this appliance to rain or moisture.

PURCHASE RECORD

REGISTRATION FOR SPECTRO ACOUSTICS FIVE YEAR WARRANTY

Model: Spectro Acoustics Model 217 (or 217R) Preamplifier

Serial Number: _____

Your Name: _____

Place Purchased: _____

Price Paid: _____

Date of Purchase: _____

Date Warranty Card Mailed: _____

The above information becomes your permanent record of a valuable purchase. It should be promptly filled in at the same time the Warranty Registration Card is completed. The card should be mailed immediately to Spectro Acoustics to insure warranty validation. Keep this page as your own record of purchase for future reference and insurance purposes. Since our warranty is transferrable in the event you sell your model 217 to a second party, this page will act as proof of original purchase date so that the second buyer knows how much time his warranty remains effective.

- Contents of Carton: (1) Model 217 or 217R Preamplifier
(1) Model 217 Owner's Manual
(1) Warranty Registration Card

Before leaving our factory, your Model 217 Preamplifier was tested and "burned in" for 96 hours minimum and was certified to be in perfect operating condition. This manual has been prepared to assist you in obtaining optimum performance and flexibility as well as maintaining the unit in top condition. With the care befitting any fine musical instrument, your Model 217 will provide a lifetime of musical enjoyment. Should there be any questions, please feel free to contact the factory directly or the dealer from whom the unit was purchased.

SPECTRO ACOUSTICS, INCORPORATED
1308 East Spokane Street
Post Office Box 2190
Pasco, Washington
99302

Telephone:
Area code 509
545-1820 or 545-1829

MAINTENANCE & REPAIR

The Model 217 Preamplifier actually requires no maintenance whatsoever with the exception of occasional cleaning of the front panel to keep the unit looking like new. The hard-anodized finish is quite rugged and may be cleaned safely with a soft lint-free rag or paper towel and an ammonia-based cleanser. The particular brand we use at the factory for pre-shipment cleaning is Parson's Sudsing Ammonia Cleanser, available at most grocery and drug stores. As an alternative, most window cleaning products (ie Windex) containing ammonia will also do an excellent, residue-free job of cleaning the front panel, top and chassis to remove finger smudges and residue buildup.

Only qualified, authorized Spectro Acoustics Warranty Service Repair Stations should be allowed to service the Model 217 in the event of internal circuitry failure. The Spectro Acoustics factory and its authorized repair stations have the equipment, parts and knowledge to quickly and reliably service any Spectro Acoustics product, either under warranty or after the warranty period is exhausted. Should you experience any difficulty whatsoever with your Model 217, please consult the dealer from which the unit was purchased first. He may be able to point out the "problem" which, in some cases, may be due to something other than the 217 itself. In many cases, faulty or intermittent connection schemes or the cables themselves will be found to be the "problem". If the unit is indeed in need of service, your dealer will be able to provide you with the name of the nearest authorized Spectro Acoustics repair facility. In some cases, the dealer himself may have an authorized repair facility in his own shop. In the event that the dealer cannot provide this information, simply write or call the factory, directly. The address and phone number are given on page 3 of this manual. When consulting the Spectro Acoustics factory on a service-related matter, please be sure to include the unit's Model number (217 or 217R), its serial number (found on rear of unit) and a brief description of the problem.

Spectro Acoustics will not accept units for repair unless previous arrangements have been made by phone or letter. We will issue a RETURN AUTHORIZATION number to you if the unit indeed requires factory attention. This is to protect us from having to pay shipping and handling charges on returned units which are not truly defective. The only way we are able to provide such high values in audio equipment is by avoiding unnecessary costs in all phases of our operation. We want you to be happy with our equipment and we do stand behind our guarantee, which is one of the most complete in the industry, but please do yourself and us a favor by writing or calling and telling us about the problem first. Then, armed with this information, we can best decide how to go about repairing the unit. If it does become necessary to ship the Model 217, we will provide you with a return authorization number. Be sure to pack the unit in its original shipping container with all foam corners and inner packing materials. In the event the original carton is not available, we will be happy to provide you with a replacement free of charge. Spectro Acoustics will not be responsible for damages incurred in shipping if the unit is improperly packed.

Thank You.

information pertaining to single-machine tape setups and non-tape systems. The monitor switch on the 217 should be left in TAPE and TP1 all the time as long as the equalizer is installed in the system.

The Model 210 can also be used in conjunction with the Model 217 in systems that contain two tape decks. Both tape recorders will be able to record equalized material when the 210 is in its EQ TAPE position, but only one of the decks' output signals can be equalized upon playback. This is because the 210 has only one TAPE MONITOR circuit. This should prove to be no serious drawback, however, since tapes can be monitored and played back with equalization added after the tape heads on one machine. Before connecting the system, you should decide which tape deck will be the master deck (both record and playback EQ) and which should be the slave deck (record EQ only). If copies are to be made from one deck to the other, and it may be desired to add equalization between the copies, so that an unequalized tape can be equalized and re-recorded on the second machine with permanent EQ added, the master machine (both record and playback EQ) should be inserted as machine #1 and the slave or copy machine should be designated machine #2.

Use the following method to connect the various equipment:

- (1) Connect the Model 217's TAPE 1 OUTPUTS to the Model 210's MAIN INPUTS
- (2) Connect the Model 210's MAIN OUTPUTS to the Model 217's TAPE 1 INPUTS
- (3) Using a pair of Y or T adapters, connect both tape machines' line level inputs to the Model 210's TAPE OUTPUTS. (Right channel 210 TAPE OUTPUT to machine 1 line level input right and machine 2 line level input right...and left channel 210 TAPE OUTPUT to machine 1 line level input left and machine 2 line level input left.)
- (4) Connect machine 1's line level outputs to the 210's TAPE INPUTS
- (5) Connect machine 2's line level outputs to the 217's TAPE 2 INPUTS

Again, for all purposes except that of listening to the outputs of machine 2 or monitoring recordings being made onto tape machine 2, leave the 217's MONITOR switches in the TAPE and TP1 positions. In this way, the equalizer can be inserted either before the inputs of tape machine 1 or 2 to make pre-equalized tapes from any selected source or after the tape machine 1 outputs, to facilitate equalization during TAPE 1 MONITORING or COPYING from TAPE 1 to TAPE 2, depending on the position of the equalizer switches.

When the equalizer is in its EQ TAPE mode, either or both tape recorders can be used to make pre-equalized recordings from the 217's selected source. To listen to the output signal (for monitoring and playback purposes) of tape machine 1, simply press the TAPE MONITOR button on the equalizer. If the EQ LINE button is also IN on the equalizer, the output signals coming from tape machine 1 will have equalization added to them after the record heads. If the equalizer is in its EQ TAPE position, on the other hand, the material being fed to tape machine 1 (and 2) will be pre-equalized, but the playback or monitor signals coming from machine 1 will not have further equalization added. Using these controls on the equalizer and the COPY and 1-2 buttons on the 217 will then allow copies to be made from machine 1 to machine 2 with (EQ LINE) or without (EQ BYPASS or EQ TAPE) equalization added between the machines. On the other hand, if it is desired to make copies from deck 2 to deck 1, simply press COPY and 2-1 on the 217, thus allowing equalized (EQ TAPE) or unequalized (EQ LINE or BYPASS) copies in the reverse direction. Naturally, the total number of possible combinations of control settings and so forth is a very high number and it is not practical to give switching diagrams for every permutation. Just remember...the only thing you can't do is to equalize the outputs of machine 2 for monitoring purposes. This is rather obvious, since to hear machine 2's outputs, the TAPE and TP 2 buttons on the 217 must be depressed, and since the tape 2 outputs come directly from the machine to the 217 TAPE 2 INPUTS without traveling through the equalizer, these signals cannot be equalized.

AFTER UNPACKING

It will be advantageous to save all of the packing materials, cartons, and foam corner supports. These materials have been especially designed to protect the Model 217 or 217R during shipping. The original packing material will prove extremely useful should you move or need to ship the unit for any reason.

Please inspect the unit carefully after unpacking. If there is any sign of damage which might have occurred during shipping, notify the dealer from which the unit was purchased immediately. Only the consignee (your dealer or yourself) can instigate a claim against the transportation company for any damage incurred in shipping, but Spectro Acoustics will cooperate fully in such an event.

Save the shipping carton as evidence of damage for their inspection!

If your unit is to be mounted in a walnut cabinet, please follow all instructions included with the cabinet during mounting. The rubber feet need not be removed for cabinet mounting.

Before connecting your new Model 217 to your audio system, it is highly recommended that this instruction manual be read carefully. Besides familiarizing you with the many special features of this product and their uses, the manual includes important information on interfacing the unit with your audio system.

INTRODUCTION

The Model 217 Straightline Preamplifier has begun a new era in the accurate reproduction of musical material recorded on phonograph discs. Aside from including the most useful features found on expensive "control console" type preamplifiers (often left out of other "straightline" designs) the 217s totally new and unique phono amplifier stage provides seven front-panel pushbuttons designed to individually tailor the input parameters and gain/frequency response characteristics of the all-important phono preamplifier stage to any of the scores of available magnetic phonograph pickup cartridges. Four of the seven phono-stage pushbuttons can be used to provide 16 different permutations of input impedance, in both the resistive and capacitive "cartridge loading". More on this important new feature later. (see PHONO STAGE CONTROLS section)

Also included among the seven phono-stage controls is a gain selector button, used to optimize noise and phono overload considerations for both low-output cartridges and higher output cartridges. Although the RIAA standard phono equalization curve remains highly accurate at any control setting, this button can be used to change the overall gain or amplification factor of the phono stage from the standard 40 dB to a less sensitive 30 dB setting, both referring to mid-band gain at a reference frequency of 1000 Hz. A sixth phono stage pushbutton activates the SSF or subsonic filter to eliminate sub-audio turntable rumble and the low-frequency mechanical/acoustical feedback problems often found in high power installations. The third order Butterworth response of this active high-pass filter allows even the lowest audio frequency information to pass unaltered while its steep downward slope of 18 dB per octave below 20 Hz virtually "wipes-out" dangerous and irritating sub-audio noise. With all this attention paid to ultra-accurate reproduction of recorded phonograph signals, the final phono-stage pushbutton is included to allow accurate A/B comparisons of two phono sources and to allow simple program selection of either phono 1 or phono 2 inputs.

The high level section of this superb piece of audio instrumentation contains a second gang of eight pushbutton controls for source selection, complete dual-machine tape recording, playback and machine-to-machine copying in either direction. Material may be recorded on both tape machines at the same time if desired, as well, and, during tape-to-tape copying, other program sources may be monitored without interfering with the copying process in any way. Dual tape monitor circuitry and switching allows off-the-tape monitoring of either machine as well as simple playback monitoring for playing back pre-recorded taped material. It is by way of these dual taping circuits that an outboard unit (such as the Spectro Acoustics Model 210 Graphic Equalizer) can be inserted into the audio path either before, between or after the tape recorders to allow pre-equalized recordings to be made on either or both decks and between-copy equalization from one deck to the other as well as straight playback equalization of material from one of the tape machines. In addition, the outboard unit (in the case of the Model 210 Equalizer anyway) can be inserted in the output lines for playback equalization of sources other than the tape recorders, including phono, tuner and any auxiliary line-level source of program material. Besides these dual tape monitor and tape copy pushbuttons (four in all) the 217 includes pushbutton source selection of either tuner, phono or auxiliary inputs and, of course, the standard mono/stereo switch, which only affects the playback signal in this case. Material at the tape outputs remains in stereo in either position of the mono/stereo switch.

GRAPHIC EQUALIZER ADD-ON

Since the Model 217 has no "tone" controls whatsoever, some users may wish to use the unit with an accessory equalizer. The Model 217 has been designed to be both electrically and aesthetically compatible with the Spectro Acoustics Model 210, a dual-channel ten-band graphic equalizer. The added flexibility available when using the "stacked" pair of units (both are 17" wide in standard form and both are available with 19" standard RETMA rack-mounting panels...option R) we would highly recommend the Model 210 as an adjunct to the 217 for the audiophile who wishes to make use of the available benefits of narrow-band octave equalization. In addition to providing room and speaker correction facilities and opening the door for "creative" equalization and the generation of special effects, the Model 210 can be used in conjunction with the Model 217 to provide complete pre-equalization for two (or more) tape machines so that recorded material and tape copies can be made with permanent equalization added during recording.

The Model 210 is provided with full switching facilities for EQ/IN-OUT, TAPE MONITOR, and EQ/LINE-TAPE arrangements and should be connected to the Model 217 by way of one of the sets of TAPE IN/OUT jacks. Two different connection schemes are presented here and the available possibilities (and impossibilities) for system equalization using the 210/217 combination are discussed fully for both set-ups. The first connection procedure is to be used in systems having only one or no tape decks. The second set-up is recommended for maximum usefulness in situations where two decks are included in the system and requires the use of two Y or T adapters, along with the necessary shielded audio cables.

The most optimum point to insert the equalizer in the audio path is at the TAPE OUTPUT/TAPE INPUT point. If your system has no tape recording facilities, simply connect the TAPE 1 OUTPUTS left and right to the MAIN INPUTS on the Model 210. Then connect the MAIN OUTPUTS of the Model 210 back to the TAPE 1 INPUTS on the rear of the 217. The Equalizer's TAPE OUTS and TAPE INs need not be connected, since there is no tape machine in the system. The MONITOR section of the Model 217's FUNCTION switch gang should then be permanently set to the TAPE and TP1 positions. (see figure B on preceding page.) This forces all signals coming from the 217's SOURCE SELECTOR group of buttons to exit at the TAPE OUTPUTS, feed through the 210 and return, equalized, to the TAPE 1 INPUTS of the 217 for monitoring. The Model 210's EQ LINE and EQ BYPASS buttons will then control whether the equalizer is in circuit or not. The Model 210 Manual will also explain the 210's operation. Since no tape equipment is included in the system we are now discussing, the TAPE MONITOR and EQ TAPE buttons on the 210 should be set to OUT and left alone.

For systems having only one tape machine, follow the same initial hookup as given above in connecting the 210 and 217 together. Again, the TAPE 1 MONITOR setting of the 217's FUNCTION switch should be permanently set (figure B). The tape machine's line level inputs should then be connected to the Model 210's TAPE OUTPUTS and the recorder's line level outputs to the 210's TAPE INPUTS. All facilities of the 210 can now be used, including EQ TAPE and TAPE MONITOR. The setup can be used to make pre-equalized tapes, while listening to unequalized versions, equalized versions, off-the-tape monitoring with or without equalization, etc. The 210 Owner's Manual should be consulted for the details of all possible uses and the switch settings (on the Model 210) that are used to implement the various possible configurations. Naturally, the equalizer can still be used to equalize other material than that associated with the tape machine by simply leaving the EQ/TAPE and TAPE MONITOR buttons on the 210 in their OUT positions. Any selected material can then be monitored while equalization is added. Again, we repeat, the Model 210 is an extremely versatile unit. The 210 Owner's Manual should be consulted for all

(B) Used for recording from the SOURCE and monitoring from TP1 (listening to the recording being made or simple TP1 playback)

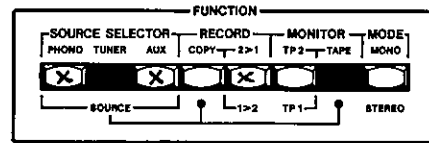

(C) Used for recording from the SOURCE and monitoring from TP2 (listening to the recording being made or simple TP2 playback)

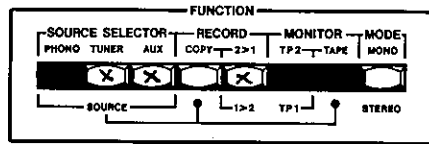

(D) Used for recording a copy from deck 1 to deck 2 while monitoring from SOURCE (copying while listening to SOURCE)

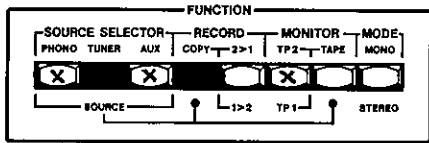

(E) Used for recording a copy from deck 2 to deck 1 while monitoring from SOURCE (copying while listening to SOURCE)

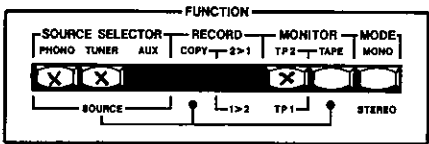

(F) Used for recording a copy from deck 1 to deck 2 while monitoring from deck 1 (listening to the original)

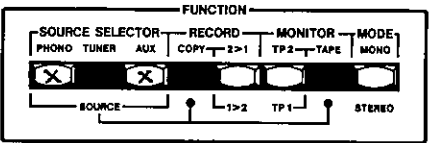

(G) Used for recording a copy from deck 1 to deck 2 while monitoring from deck 2 (listening to the new copy)

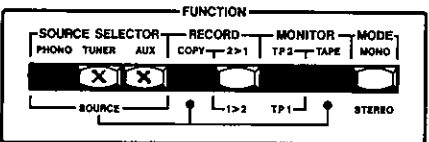

(H) Used for recording a copy from deck 2 to deck 1 while monitoring from deck 2 (listening to the original)

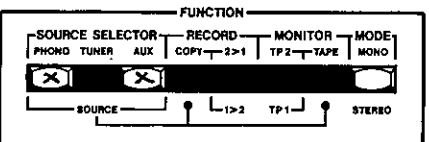

(I) Used for recording a copy from deck 2 to deck 1 while monitoring from deck 1 (listening to the new copy)

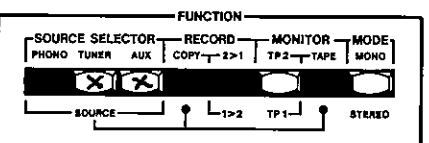

In addition to the 15 pushbutton switches on the front panel which control the phono stage parameters and all signal-routing functions, the Model 217 includes a pair of high-accuracy silicone-damped rotary controls for balance and level setting. Precision-machined aluminum knobs add the final touch of professional look and feel to the Model 217's bold instrumentation-format front panel. The balance control features a center "click" detent at the center-balanced position, while the dual-element level (volume) control also functions as a power on/off switch. A small solid-state LED (light emitting diode) is used on the front panel for power on/off indication.

Two identical audio channels and seventeen front-panel controls... truly amazing versatility in an inexpensive yet studio-grade audio pre-amplifier...the Spectro Acoustics Model 217.

FRONT PANEL CONTROLS

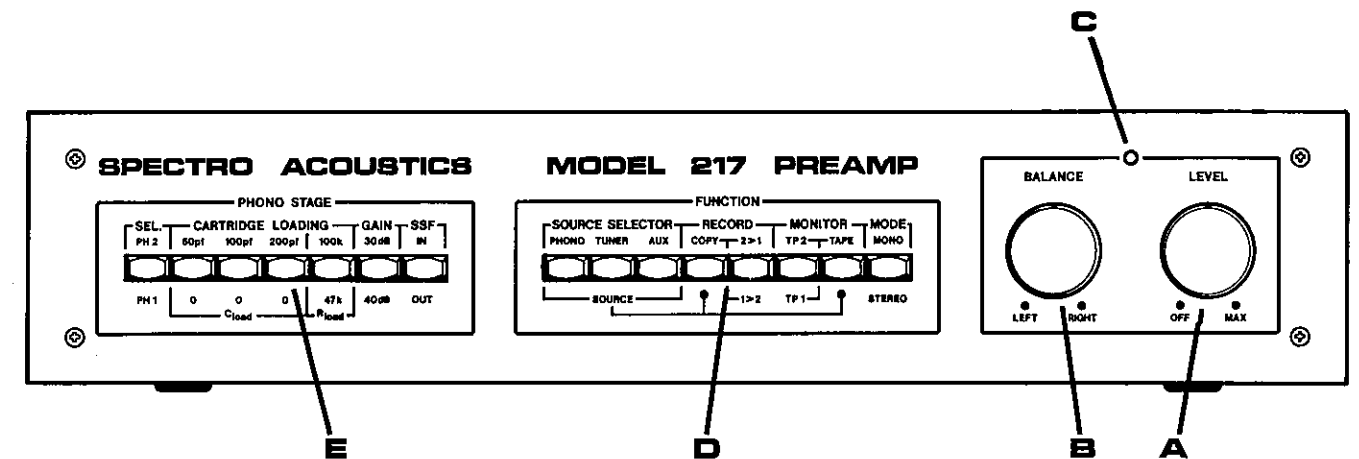

CONTROL NAME

CONTROL FUNCTION

(A) Level Control & On/Off Switch

Turns power on and off, sets listening level (no effect on tape output levels)

(B) Balance Control

Adjusts left to right level balance, from equal to fully left or fully right (no effect on tape output balance)

(C) Pilot LED

Glows red when power is turned on

(D) Function Switch Group

Controls all signal selection, routing and mono/stereo switching

(E) Phono Stage Switch Group

Controls all variable parameters of the RIAA magnetic phonograph preamplifier input stage and selects between phono 1 and phono 2 inputs

Note: The MONO/STEREO switch, not previously discussed, simply connects the two stereo channels together before the balance control for monaural listening, when pushed IN.

REAR PANEL CONNECTIONS

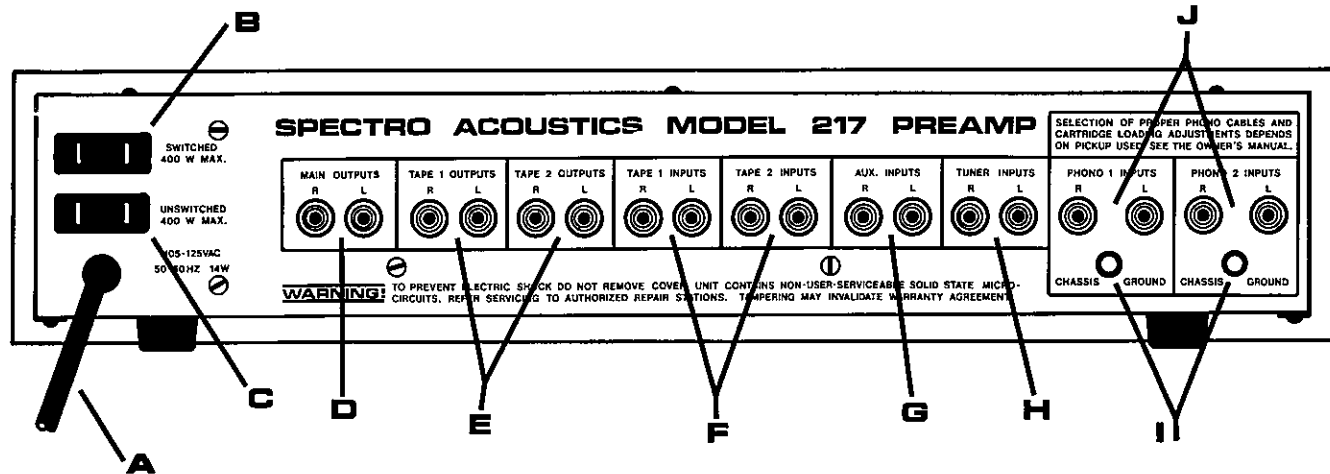

CONNECTION NAME

(A) Line Cord & Plug

(B) Switched AC Outlet

(C) Unswitched AC Outlet

(D) Main Outputs L & R

(E) Tape 1 Outputs L & R

CONNECTS TO:

Source of AC power as marked on rear panel nameplate rating. 50 or 60 Hz, 14 Watts, either 105-125 Volts (standard unit) or 210-250 Volts (export unit) Power draw will rise to 814 watts maximum with full rated use of AC convenience outlets.

Any auxilliary piece of equipment that is to be switched on and off by the preamp's power on/off switch. Do not exceed the maximum rating of 400 watts.

Any auxilliary piece of equipment that is provided with its own on/off switch or that has an automatic-shutoff feature, such as a record changer or turntable. Do not exceed the maximum rating of 400 watts.

Power amplifier inputs or electronic cross-over inputs. Able to drive several typical power amplifier inputs simultaneously if desired. Use Y or T adapters to provide more jacks as necessary for driving multiple amplifier systems. (300 ohm output impedance) The signal present at these jacks is the signal you will hear, as selected by the MONITOR switches and controlled by the mono/stereo switch and level/balance controls.

Tape recorder's high level or line level inputs. The signal present at these jacks is identical at all times to the signals at the tape 2 output jacks, and is the signal that will be recorded on the tape machine(s), as selected by the RECORD switches. The Tape Output signals are not affected by the level, balance or mono/stereo controls. Connects to LINE INPUTS of add-on units such as the Model 210 Graphic Equalizer (see Graphic Equalizer Add-on)

the COPY direction. If your master recording is being played back on deck 1, for copying to deck 2, the button is left in the OUT position, and vice-versa. The RECORD pair of buttons has no effect on what material is present at the MAIN outputs, for MONITORING through your power amplifier and loudspeakers. In addition, the MONO/STEREO switch and BALANCE and LEVEL controls have no effect on any material being recorded, whether it is the SOURCE material or a COPY from the other tape deck. This arrangement allows the user to set his listening levels independently of his record levels and, as you will see shortly, allows COPIES to be made from either machine to the other while allowing the user to MONITOR the SOURCE material. In other words, copies can be made from deck to deck while listening to a totally different program, from the PHONO, TUNER or AUX inputs, as selected by the SOURCE SELECTOR. The diagram below illustrates the proper switch configuration for dubbing a copy from deck 2 to deck 1 while listening to the PHONO. The diagram on the right shows dubbing from deck 1 to deck 2 while MONITORING from the TUNER.

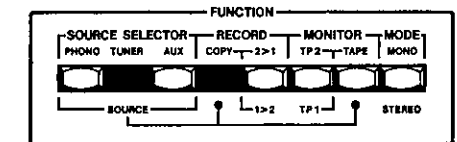
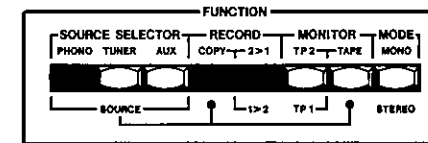

The MONITOR switch pair operates in the same way as the RECORD pair, with a master and secondary button, but instead of controlling what material is available at the TAPE outputs, these buttons control what will be sent through the MONO/STEREO switch, BALANCE and LEVEL controls to be presented at the MAIN outputs for listening, or MONITORING purposes. When the main button in this group (TAPE/SOURCE button) is OUT, the selected SOURCE material will be heard. This position is used for simple listening purposes on PHONO, TUNER or AUX input program material. When the TAPE/SOURCE button is in the SOURCE (OUT) position, the other button in the pair (TAPE 2/TAPE 1) has no effect. If the TAPE/SOURCE button is pushed IN, to its TAPE position, the outputs of either machine 1 or machine 2, as selected by the TP2/TP1 button, will be available for simple tape playback or tape monitoring while recording or copying. There are nine valid set-ups possible between the two groups of buttons. The following listing, accompanied by button diagrams of all nine settings will show the proper set-up to implement any signal-routing function necessary. Again, blackened buttons are IN, uncolored buttons are OUT and buttons with an X are "don't care" in that they have no effect.

(A) Used for simple listening to source material and un-monitored recording of source material.

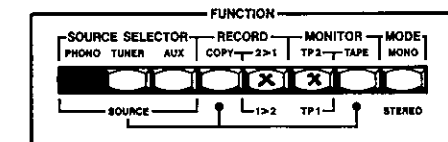

FUNCTION SWITCH

The layout and markings associated with the FUNCTION switch group are designed to be easily understood and are almost self-explanatory, at least to the seasoned audiophile. In many cases it seems that pushbutton type switching is not as straightforward and free of confusion as say rotary or lever type switching. In the case of the Model 217 (and all Spectro Acoustics products) however, the FUNCTION switch design has been carefully optimized in terms of maximum flexibility while retaining the logical and "human-engineered" approach based on function grouping. The control layout is logical, in that not only does it show signal flow, from left to right, but (as often happens in well-planned, logical designs) that it also represents the best internal layout organization to reduce the length of all internal circuitry traces, thus keeping hum, noise and rise-time to their lowest possible levels on both channels. The following description of the FUNCTION switch gang operation can be enhanced by referring to the schematic diagram at the end of this manual. For the sake of convenience in reading the diagram, all switches have been drawn so that their schematic positions (up or down) agree with their physical/electrical configurations. That is, a switch shown in the UP position on the schematic represents a button pushed IN, and vice-versa. On the front panel, the legends printed at the bottom of each switch show what function is implemented with the button OUT and the legends at the top show what happens when the button is pushed IN. Each group's title indicates which portion of the circuitry is affected by the group.

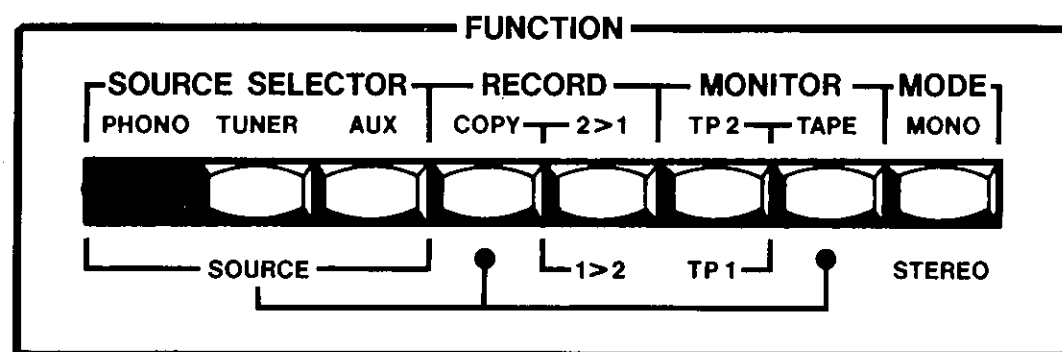

Referring to the first FUNCTION switch drawing, above, let's look at the signal flow from left to right. The SOURCE SELECTOR group consists of three interlocking buttons, of which only one is pushed in at a time. The diagram above shows that the PHONO stage has been selected as the program source in this case. As shown in the diagram, below the SOURCE SELECTOR, RECORD and MONITOR groups, the selected SOURCE material is fed to both the RECORD switch pair and the MONITOR switch pair.

Each of these two pairs of buttons has a master button and a secondary button. The RECORD pair determines what material will be present at the TAPE OUTPUTS, both 1 and 2, for recording purposes. The master button in this pair is the COPY/SOURCE button, on the left. When the COPY/SOURCE button is OUT, as in the diagram, the SOURCE material selected by the SOURCE SELECTOR is directed to the tape outputs for recording. With this button OUT (SOURCE position) the position of the other button in the pair has no effect, and the selected SOURCE material can be recorded on either or both tape machines, with no further switching necessary. When the COPY/SOURCE button is pushed IN, however, the material present at the TAPE OUTPUTS for recording will be whatever material is coming from the other tape machine. In the COPY position, the other button, 2-1/1-2 becomes activated, allowing you to choose

(F) Tape 2 Outputs L & R

Tape machine #2's high level or line level inputs. (see (E) Tape 1 Outputs)

(G) Auxilliary Inputs L & R

Outputs from any line level source of program material with up to 10 volts output level.

(H) Tuner Inputs L & R

Outputs from stereo tuner or other line level source of program material with up to 10 volts output level.

(I) Chassis Ground Lugs

Phonograph turntable ground leads ONLY. DO NOT GROUND SPEAKERS OR OTHER GROUND CONNECTIONS TO THIS POINT. If turntable(s) have no ground wires, leave these lugs unconnected.

(J) Phono Inputs 1 & 2, L & R

Magnetic phonograph cartridge outputs only. (see PHONO STAGE CONTROLS section for cartridge loading considerations and selection of optimum phono cables) Ultra-low output "moving coil" type cartridges require the insertion of a matching transformer or pre-amplifier, available from cartridge manufacturer.

INSTALLATION

A few simple rules to follow when connecting your new preamplifier to your audio system will assure proper operation the first time and maximize the total system's performance.

- (1) Always connect an input of one piece of gear to an output of another, and vice-versa. Never connect two outputs together or two inputs together. It is permissible to use Y or T connectors if more than one power amplifier or tape machine is to be driven by the line or tape outputs on any Spectro Acoustics equipment. In this case, you are actually connecting two inputs together and an output, which is permissible only because the very low output impedance (high current and drive capability) of all Spectro Acoustics equipment allows several medium or high impedance inputs to be driven simultaneously by a single pair of output jacks. Never, under any circumstances, however, connect two outputs together on any equipment and never connect the Model 217's line and tape outputs together. There is no reason to do this in any case, and possible damage could result, since each output would force current into the other output.
- (2) The inputs of the Model 217 should not be overdriven by direct connection to high level power amplifier or outputs intended to drive loudspeakers. In no event should any input be subjected to signal levels above ten volts rms. The Tape, Tuner, and Auxilliary inputs of the Model 217 are designed to be connected to any source marked "line output", "main output", "monitor output", etc. Attempting to drive these inputs with very low level signals (from microphones or musical instrument pickups, for instance) will result in very low level signal output and lack of loudness or volume even at the maximum

position of the level control.

- (3) Use shielded audio cables available at any hi-fi store for all signal connections. RCA type "pin-plugs" of the standard variety will mate correctly with the Model 217 input and output jacks. The special jacks used in the Model 217 have internal shorting switches that ground all unused inputs to eliminate hum and potential crosstalk. Some non-standard pin plugs are equipped with pins that are too long to mate properly with these jacks. These are extremely uncommon, however, and are generally only sold in Europe and foreign countries. The vast majority of standard audio cables available throughout the world will mate perfectly with these jacks. Be sure to insert the plugs all the way into the jacks, in order to break the shorting connection. 90% of all "intermittent" problems can be traced to broken audio cables or improper insertion. All cables should be kept to a reasonable length (six feet or less for line level inputs and tape outputs and 25 feet or less for main outputs) to avoid hum and high frequency losses due to cable capacitance. If accurate cartridge loading adjustments are to be made, the cables leading to the phono inputs must be of known capacitance. (See Phono Stage Controls section)
- (4) When connecting other equipment to the Model 217's AC outlets, be sure to observe the maximum rating marked near these outlets and do not overload them with equipment whose nameplate wattage rating exceeds that maximum level.

After connecting the Model 217 to your other equipment as described in the section on REAR PANEL CONNECTIONS, you are ready to enjoy music. For connection procedures for adding signal processors (ie Model 210 Graphic Equalizer) to the system see GRAPHIC EQUALIZER ADD-ON.

If you are at all confused about hookup procedures, please inquire either to the retail outlet from which the unit was purchased or, if your problems and questions still remain unanswered, directly to the Spectro Acoustics factory, whose address and telephone number is given on page 3 of this manual.

PHONO-STAGE CONTROLS

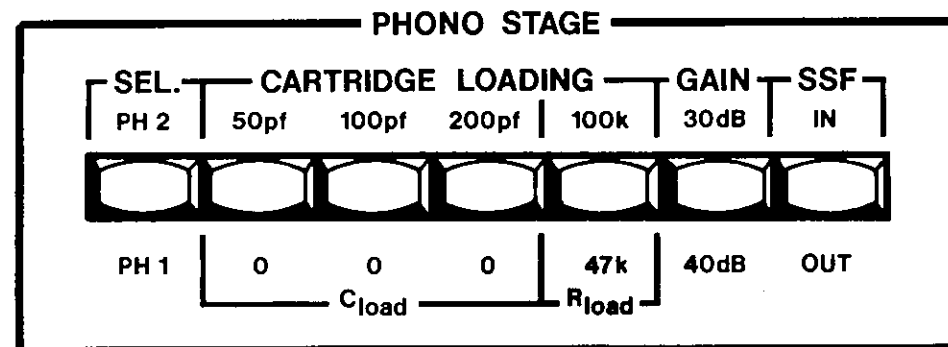

30dB/40dB SWITCH The output level of various magnetic phono cartridges for a given velocity can range tremendously. Some cartridges, known as "hot" cartridges, put out two to four times the output voltage of other, less sensitive, cartridges. This poses quite a problem in preamplifier stage design, since a preamp designed to provide enough amplification for the least sensitive low output cartridges might tend to overload when used with the "hot" cartridges presently available. As a rule, 40dB at 1000 Hz is the standard amount of amplification designed in to most phono preamps (measured from phono in to tape out). If the equipment is designed with a power supply voltage that allows a ten volt output before clipping (at 1000 Hz), it takes 100 millivolts at the phono inputs to cause overload...resulting in distortion. This is fine for many low-output cartridges, but there are now a few units on the market that can exceed this output level quite easily on certain recorded material with wide dynamic range and records that are "cut hot". Besides the possibility of input stage overload, it is desirable to optimize the gain of the input stage for best S/N ratio for any given cartridge. The high output models can be used with much less input stage amplification, resulting in a better S/N ratio overall, since the noise created by any phono stage will be related to the stage gain, or amplification factor. In addition, power amplifiers can vary in input sensitivity over a wide range, again creating a need for some means of optimizing input stage gain so that the useable range of the volume control is maximized. In other words, a preamp with 40dB gain in its input stage and say, 15dB gain (at full volume) in its high level stage might cause a sensitive power amplifier to be driven to very loud levels at a low volume control setting, making level adjustment very difficult since only a small portion of control travel can be used. The 30/40dB switch on the Model 217's phono stage amplifier can be used to optimize the overload characteristics, S/N ratio and level control range of adjustment for any combination of cartridge and power amplifier sensitivity. When out, the button allows the normal phono gain of 40dB and when pushed in, for hot cartridges or sensitive power amplifiers, limits the phono stage gain to 30dB, causing a ten dB decrease in gain and system noise. The proper setting of this switch is best determined experimentally, and, using reasonable care and normal volume control settings, no damage will be done even if the setting is incorrect. It is somewhat dangerous to loudspeakers, however, if you have the switch in its 30dB mode and the volume is cranked wide open and then suddenly the switch is returned to its 40dB position. The extra 10dB of gain can cause a large sudden power increase to the speakers, and in the case of very high power amplifiers, this can be hard on the speakers. In any event, experimentation with the 30/40dB switch is no more dangerous than simply opening the volume control fully which, as some have found out, can destroy loudspeakers rather rapidly in the case of a high power amplifier.

SUBSONIC FILTER (SSF) The subsonic filter included in the PHONO STAGE controls can be effectively used to eliminate sub-audio turntable rumble and acoustic/mechanical feedback. When in the "out" (physically) position, the low frequency response of the phono stage extends to well below 20Hz before a gentle 6dB per octave rolloff begins to occur. When the SSF button is pushed in, however, a third order filter of the Butterworth (minimum ripple) design is inserted, causing a 3dB rolloff at 20Hz and an 18dB per octave attenuation of frequencies below 20Hz. This filter has no effect on the audio information of any material presently available on phono discs, yet can almost totally eliminate the unwanted sub-audio information that is often present in turntables and phonograph records.

PHONO 1/PHONO 2 SWITCH This simple switch is almost self-explanatory. When out, the phono input stage is connected to the phono 1 input jacks and material from that turntable can be played back or recorded. When pushed in, the phono 2 inputs are connected.

NOTE: The entire phono stage is controlled by the FUNCTION SWITCH group marked SOURCE SELECTOR. Regardless of the positions of any of the PHONO STAGE switches, phono inputs will only be heard or recorded when selected by the SOURCE SELECTOR PHONO button.

internal wiring...about 18pF) and a 47K ohm resistance. It is important to note that cable capacitances vary tremendously from cable to cable. As a general rule, the "garden variety" stereo patch cords available at most hi-fi stores run about 40 to 50 pF per foot, so a three foot cable (of this type) will exhibit about 150 picofarads, while a six foot cable will run about 300 pF.

In order to assure accuracy in the cartridge loading adjustments (capacitive), the cable capacitance must be a known quantity. As a rule, turntables that are provided with permanently-attached cables use relatively low capacitance (high quality) cables on the order of about 80 pF. This works out quite nicely, since the 217's residual input capacitance with all three switches out is about 18 to 20 pF, so the combined cable/residual capacitance can be figured at 100pF. This allows the 217 a range of adjustment from 100pF to 450pF, which covers the range of manufacturer's recommendations completely. For turntables that come with detachable cables, of the standard stereo variety, the cable capacitance is an unknown factor. In this case, we recommend the use of cables such as Discwasher's "Goldens", a high quality cable whose capacitance, when combined with the 217's residual and the small capacitance of the tonearm leads is also a known 100pF. Some typical capacitive loading adjustments and their values (including 100pF cable capacitances) are shown in the diagrams below. The buttons in black are pushed in, the uncolored buttons are out. As you can see, the range and resolution of the adjustment is quite well suited to meeting any loading requirement, since each button may be used individually or in concert with the others.

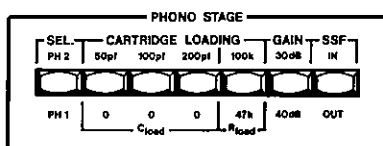

47K ohms, 100pF+0=100pF

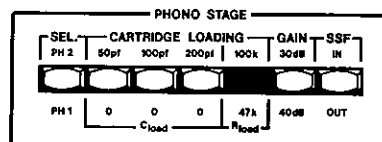

100K ohms, 100pF+0=100pF

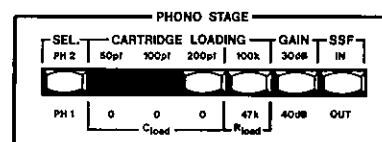

47K ohms, 100pF+150=250pF

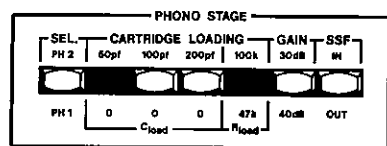

100K ohms, 100pF+50=150pF

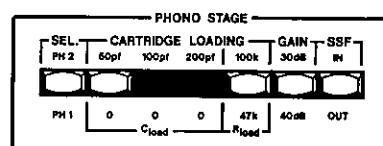

47K ohms, 100pF+300=400pF

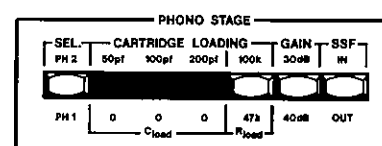

47K ohms, 100pF+350=450pF

NOTE: The audible effects of changing the resistance from 47K to 100K are quite noticeable on most any system, and generally speaking, the high frequency content will be increased as the resistance is increased, with any cartridge.

The effects of varying the loading capacitance are much more subtle, and in some cases, where the overall system response is less than ideal or in the case of certain rather insensitive cartridges, no immediately audible effects will be noticed when ranging through the various capacitance settings. However, for many very high quality systems and cartridges, the subtle effects of proper or improper capacitive loading at the phono inputs, although generally not extremely prominent, audibly, can be noticed quite readily by ear. Measured responses will usually show deviations of from 2 to 7 dB at selected high frequency points, depending on the cartridge in use and the capacitive loading setup.

Before describing the actual operation of the phono stage controls and the implementation of the 16 different cartridge loading input impedance permutations, let's discuss the reasoning behind the elaborate control setup and the justifications for the unique phono stage design used in the Model 217.

In recent years, audio enthusiasts have been treated to tremendous advances in the technology of accurate sound reproduction. Noise and distortion of all kinds have been reduced to such low levels in much of today's "high-end" audio gear that accurate detection and measurement of these tiny quantities often tests the limits of the most sophisticated scientific measuring equipment available and in most cases (where typical test equipment is used) cannot be measured at all, due to test equipment residual noise and distortion figures. Basic amplification circuitry has been improved to such a degree that today's advanced audio designers often take it for granted and apply their skills to the design of new equipment and techniques to electronically correct for the limitations of recorded material, loudspeakers, microphones, pickups and room acoustics. The literal flood of add-on noise reduction units, graphic equalizers and dynamic range restoring accessories attests to this modern struggle to bring the rest of the audio reproduction chain up to the performance level of today's amplification circuitry. One might draw the conclusion from this that no further advances in simple signal amplification are necessary or desirable and that all modern equipment that measures out well on typical steady-state signal tests using signal generators and analysers will add no unwanted effects to musical program material.

But if electronic amplifiers and preamplifiers are indeed so close to perfection as some manufacturers (and most specifications) would have us believe, why is it that two identically specified preamplifier sections or phono cartridges might sound quite different to the ear on musical program material? Certainly the difference between 0.05% and 0.01% or between 0.0075% and 0.005% distortion in two different units cannot be heard or readily recognised as the reason for two units not sounding the same. Nor can a minor deviation in steady-state frequency response (especially beyond the extremes of the audio spectrum) be pin-pointed as the culprit. There are many possible reasons for sonic differences between units that, according to their specifications, should sound identical. Some of the reasons now being investigated are TIM distortion (a phenomenon related to open-loop bandwidth, slew rate and fast-rise input signals in negative feedback amplifiers) the effects of phase shift (another phenomenon associated with time-lag delays in negative feedback amplifiers) and the effects of various output stage configurations on amplifier "clipping" and saturation and their related sonic effects. Since all amplifier stages require negative feedback (either overall or local) to attain flat, controlled amplification of a predictable, known amount, the importance of these considerations cannot be overlooked. The answers to these potential trouble-spots lie for the most part in the development of amplifier circuitry that is free of significant internal time-lags enclosed in the feedback loop and free of pre-mature overload and saturation. The devices used in the Model 217, and all Spectro Acoustics preamplifier and equalizer products satisfy these requirements quite nicely, having open-loop gain and bandwidth parameters far exceeding that required to allow freedom from these potential problems. Other designs can also boast the same excellent characteristics in this respect, due to the ever-improving state of modern electronic devices, particularly monolithic "op amps". Yet, still, in many cases, the readily apparent sonic differences between preamp A and preamp B or phono cartridge A and cartridge B seem to transcend these considerations. What possible other causes could be at the root of these seemingly impossible sonic differences? We believe that the interface between the sensitive phono cartridge and its preamplifier contains the answer to this question in many cases.

Unlike the typical audio signal generators generally used to test the frequency responses of phonograph preamp stages, a magnetic phono cartridge represents a

highly complex reactive signal source, whose output signal depends not only on the physical motion of the stylus but to a great degree is affected by the load "seen" by the cartridge at the phono inputs of the preamplifier. The overall frequency response of the cartridge/preamp combination is often highly dependent on this cartridge "loading" effect and, when improperly loaded, an excellent phono cartridge can be degraded to the point that its potential for true "hi-fi" reproduction is not realized.

Due to this subtle interaction between magnetic cartridge and preamplifier, the manufacturers of phono pickups nearly always specify the optimum cartridge loading that yields the best frequency response overall for their product. This cartridge loading specification is given in terms of two parameters: resistance and capacitance. Some fine cartridges will work best into very "light" loading, 100K ohms and 100pF or less in some cases, while other equally fine models might specify much heavier loading to obtain the flattest response and freedom from uncontrolled peaks and dips, especially at the high frequency end of the audio spectrum. Most Shure cartridges, for instance, offer optimum performance when loaded with as much as 500 pF and a resistance of 47K ohms. Generally, the resistance value suggested by the cartridge manufacturer will be either 47K ohms or 100K ohms, while the recommended capacitance can range from 100pF to 500 pF. Some cartridges are relatively immune to loading changes, particularly capacitive loading, yet others display huge audible differences when loaded differently. This generally depends on the inductance and resistance of the magnetic windings in the cartridge itself. Some excerpts from recent popular audio publications and manufacturers literature bear out this often devious effect of improper cartridge loading:

C.G. McProud... "How we test a phonograph cartridge"....Audio Magazine says:

"...there are often such peaks, so further graphs are made on both channels with additional capacitance across the leads. The normal capacitance of typical turntable leads is on the order of 250 pF (Note: although it can vary greatly), and we add increments of 50 pF across the leads and make further series of curves which show the effects of added capacitance. (Reading the instructions) is of no less importance with cartridges, for the manufacturer is likely to suggest the optimum capacitance into which the cartridge should work. Even if he doesn't, however, we find it ourselves. If it is found that a flatter response is obtained with a specific value of capacitance, we so indicate, and all further testing is done with the value in the circuit. In addition to reducing possible peaks, the proper value of load capacitance also helps to remove the "swayback" that often occurs in the 5000 to 8000 Hz range."

Julian Hirsch... "Shure Model M95ED Review"....Popular Electronics says:

"(with the turntable's standard tonearm and cable capacitance) the response had a peak of about 4dB at 16kHz. Since Shure recommends a load capacitance of 400 to 500 pF for flattest response, we added capacitance to bring the total to 440pF and measured the response again. This time it was notably flat, varying \pm 1dB from 40 to 17,500 Hz."

Empire Electronics... "Blueprint for flat frequency response"....says:

"...frequency response was measured using the CBS 100 test record, which sweeps from 20Hz to 20,000Hz. The vertical tracking force was set at 1 gram. Nominal system capacitance was calibrated to be 300pF and a 47K ohm resistance was maintained throughout testing..."

"If proper phono cartridge loading is as important as these excerpts tell us" one might ask, "why then don't all preamp manufacturers include some means of adjusting these parameters?" There are several possible reasons why. Some manufacturers dismiss the problem altogether, saying that phono leads could be mech-

anically trimmed in length to provide the correct capacitance. This is fine if a low capacitance is desired (reasonably short cable) but allows no way to change the resistive impedance and, in addition, it is highly impractical in the case where the user wishes to experiment with several different cartridge models. Most preamps either include no additional cartridge loading capacitance (and rely strictly on cable capacitance for proper loading) while others attempt to add an "average" amount of loading capacitance to suit the "average" cartridge...a beast which is rather rare, at best. Still, no means of changing the resistive load from 47K to 100K ohms is provided in these instances. Then there is the problem most audio manufacturers face in that their products are aimed at the mass marketplace, where unfamiliar adjustments and procedures can "scare off" potential buyers.

Another main reason preamp (and receiver) manufacturers almost never provide cartridge loading adjustments on their products is that it is a somewhat difficult procedure to design any switchable circuitry into the sensitive, hum-prone phono input circuitry, without introducing clicks, ticks, pops and hum during switching. Also, the phono stages used by most manufacturers are based on discrete tube, FET or transistor designs which, in many cases, offer very limited isolation between the RIAA feedback frequency response-shaping network and the sensitive input point where cartridge loading elements must be located. This lack of isolation causes a reflected load at the input that is a function of the RIAA feedback elements, the isolation factor and the signal frequency, all of which are rather hard to isolate. In addition, the DC biasing networks associated with typical discrete designs often limit the possibilities for total freedom in loading anyway. These unfortunately interwoven considerations tend to place rather severe and often unpredictable limitations on the range of possible cartridge loading, so the manufacturer simply declines to specify or even comment on the true load seen by the phono cartridge in actual use, giving rise, in many cases, to the obvious sonic differences between phono stages that are, according to the specs, identical.

By using recently developed monolithic IC operational amplifiers with truly isolated feedback and signal input points (differentially-balanced) instead of the normal discrete tube or transistor designs, Spectro Acoustics has been able to design a phono amplifier stage with such a high degree of isolation between the RIAA feedback network and the signal input point that full control of cartridge loading becomes not only possible, but quite practical as well. Earlier IC-type phono stages were either too noisy or had other problems related to distortion or signal-handling capability. The type 4136 devices used in all Spectro Acoustics preamp and equalizer products contain four gain and phase-matched op amp sections on a single, temperature-matched silicon substrate (chip). In addition to the very high isolation between input and feedback points, the 4136 offers an open-loop bandwidth of 3 megahertz, 105dB isolation between the four stages, 0.1 microsecond risetime, noise levels below that of any available program material, distortion figures that are competitive with the best discrete designs (and better in some cases, IM distortion in particular) and enough output drive power to drive several tape recorders or power amplifiers simultaneously. Each tiny IC package contains over 50 transistors, along with several FET devices and a handful of resistors.

SETTING UP FOR YOUR CARTRIDGE(S)

The Model 217's cartridge loading adjustment facilities take the form of four pushbutton switches. Three of these switches switch in capacitors across the input points in a 50-100-200 pF arrangement, while the fourth switch sets the input resistance to either of the two standard values, 47K ohms or 100K ohms. The capacity switches are independently operated, so that any additional capacitance (over and above the normal cable capacitance) of from zero to 350pF can be added, in 50pF steps. In other words, if all switches are out, the phono cartridge sees only the cable capacitance (plus an insignificant residual capacitance associated with the