

SERVICE MANUAL

INTEGRATED AMPLIFIER SANSUI AU-D33/D22

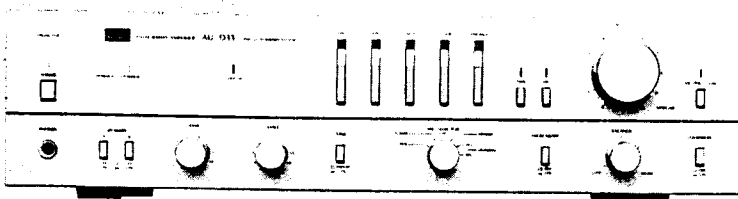

RTV servis Horvat

Tel: ++385-31-856-637

Tel/fax: ++385-31-856-139

Mob: 098-788-319

www.rtv-horvat-dj.hr

THE QUALITY OF
THIS MANUAL IS
THE BEST THAT
IS AVAILABLE



SANSUI ELECTRIC CO., LTD.

www.rtv-horvat-dj.hr

● SPECIFICATIONS

<AU-D33>

Power output

MIN. RMS, both channels driven, from 20 to 20,000 Hz with no more than 0.004 % total harmonic distortion

50 watts per channel into 8 ohms

Load impedance 8 ohms

Total harmonic distortion

. less than 0.004 % at or below rated min. RMS power output

Intermodulation distortion (60 Hz : 7 kHz = 4:1 SMPTE method) less than 0.006 % at rated

Frequency response (at 1 watt)

Overall (from AUX) . DC to 300,000 Hz +0 dB, -3.0 dB

RIAA curve deviation (PHONO-MM, 20 Hz to 100 kHz)

. +0.2 dB, -0.5 dB (REC OUT)

Damping factor (1 kHz, both channels driven)

. 40 into 8 ohms

Input sensitivity and impedance (at 1 kHz)

PHONO-MC 250 μ V/100 ohms

(Max. input capability: 12 mV at 1 kHz, less than 0.1 % total harmonic distortion)

PHONO-MM 2.5 mV/47 kilohms

(Max. input capability: 170 mV at 1 kHz, less than 0.01 % total harmonic distortion)

AUX, TUNER, TAPE PLAY-1, 2

. 200 mV/47 kilohms

Output level (1,000 Hz)

TAPE REC-1, 2 200 mV into 47 kilohms

Channel separation (1 kHz, at rated power output)

PHONO-MM 72 dB

AUX, TUNER, TAPE PLAY-1, 2

. 90 dB

Signal to noise ratio (short-circuit, A-network)

PHONO-MC 65 dB

PHONO-MM 84 dB

AUX, TUNER, TAPE PLAY-1, 2

. 105 dB

Controls

BASS \pm 10 dB at 50 Hz

TREBLE \pm 10 dB at 10 kHz

LOUDNESS +8 dB at 100 Hz

+5 dB at 10 kHz

Others

Power voltage 100/120/220/240 V (50/60 Hz)

For U.S.A. and Canada

. 120 V (60 Hz)

Power consumption 210 watts 240 VA Rated

300 watts Maximum

Dimensions 430 mm (16-15/16") W

112 mm (4-7/16") H

334 mm (13-3/16") D

Weight 7.3 kg (16.1 lbs.) net

8.3 kg (18.3 lbs.) packed

to be continued▶

COMET

<AU-D22>

Power output
 MIN. RMS, both channels driven, from 20 to 20,000 Hz with no more than 0.006 % total harmonic distortion
 35 watts per channel into 8 ohms
Load impedance 8 ohms
Total harmonic distortion
 less than 0.006 % at or below rated min. RMS power output
Intermodulation distortion (60 Hz : 7 kHz = 4:1 SMPTE method) less than 0.007 % at rated
Frequency response (at 1 watt)
 Overall (from AUX) . 20 to 300,000 Hz +0 dB, -3.0 dB
RIAA curve deviation (PHONO-MM, 20 Hz to 100 kHz)
 +0.2 dB, -0.5 dB (REC OUT)
Damping factor (1 kHz, both channels driven)
 40 into 8 ohms
Input sensitivity and impedance (at 1 kHz)
 PHONO-MC 250 μ V/100 ohms
 (Max. input capability: 12 mV at 1 kHz, less than 0.1 % total harmonic distortion)
 PHONO-MM 2.5 mV/47 kilohms
 (Max. input capability: 170 mV at 1 kHz, less than 0.01 % total harmonic distortion)
 AUX, TUNER, TAPE PLAY-1, 2
 200 mV/47 kilohms
Output level (1,000 Hz)
 TAPE REC-1, 2 200 mV into 47 kilohms
Channel separation (1 kHz, at rated power output)
 PHONO-MM 60 dB
 AUX, TUNER, TAPE PLAY-1, 2
 90 dB

Signal to noise ratio (short-circuit, A-network)
 PHONO-MC 65 dB
 PHONO-MM 84 dB
 AUX, TUNER, TAPE PLAY-1, 2
 105 dB
Controls
 BASS \pm 10 dB at 50 Hz
 TREBLE \pm 10 dB at 10 kHz
 LOUDNESS +8 dB at 100 Hz
 +5 dB at 10 kHz

Others
Power voltage 100/120/220/240 V (50/60 Hz)
 For U.S.A. and Canada
 120 V (60 Hz)
Power consumption . . . 160 watts 190 VA Rated
 270 watts Maximum
Dimensions 430 mm (16-15/16") W
 112 mm (4-7/16") H
 334 mm (13-3/16") D
Weight 6.8 kg (15.0 lbs.) net
 7.8 kg (17.2 lbs.) packed

* Design and specifications subject to change without notice for improvements.

1. BLOCK DIAGRAM

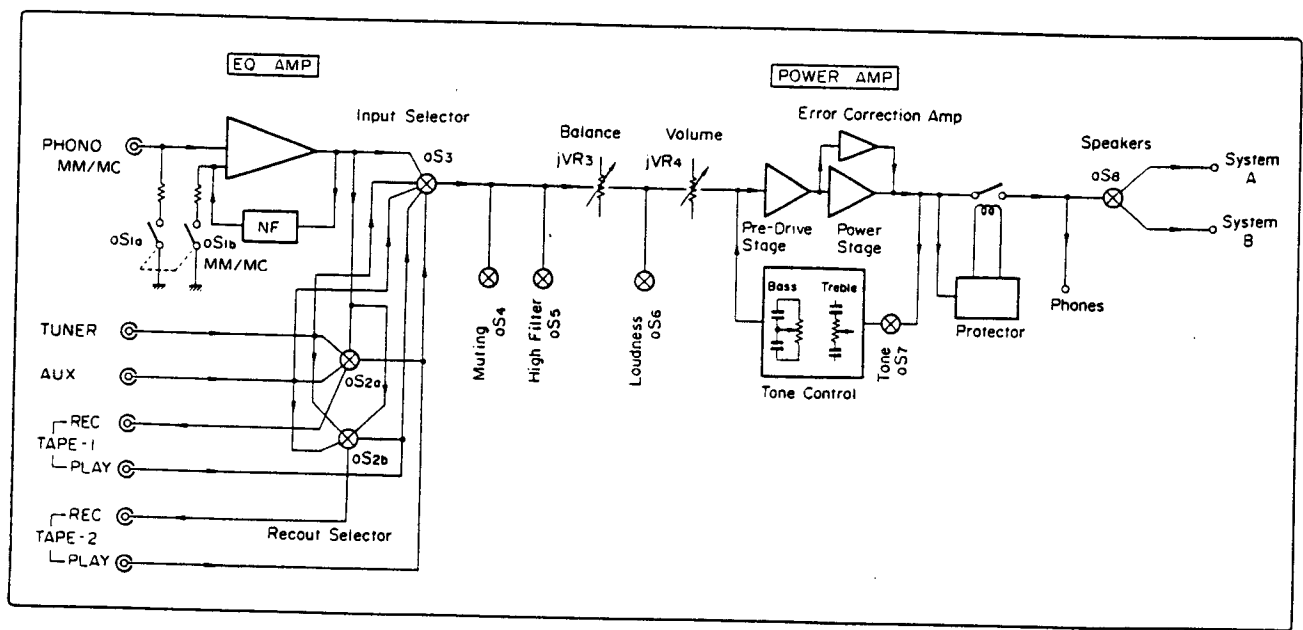

2. PARTS LOCATION & PARTS LIST

• Since some of capacitors and resistors are omitted from parts lists in this Service Manual, refer to the Common Parts List for capacitors & resistors, which was appended previously to Sansui Manual.

2-1. F-3578 Equalizer Amp Circuit Board (Stock No. 00655401 = AU-D33/00662401 = AU-D22)

Component Side

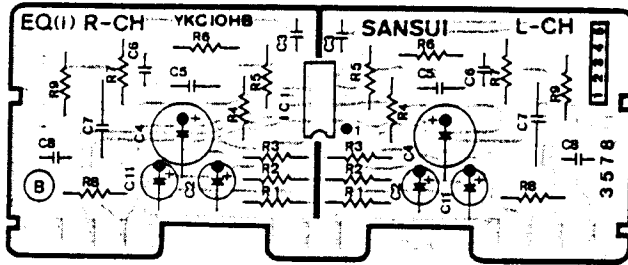

Parts List

Parts No.	Stock No.	Description
•IC		
iIC1	46151400	NJM2043D

2-2. F-3592 Power Supply, Protector Circuit Board (Stock No. 00657101 = AU-D33/00671701 = AU-D22)

Component Side

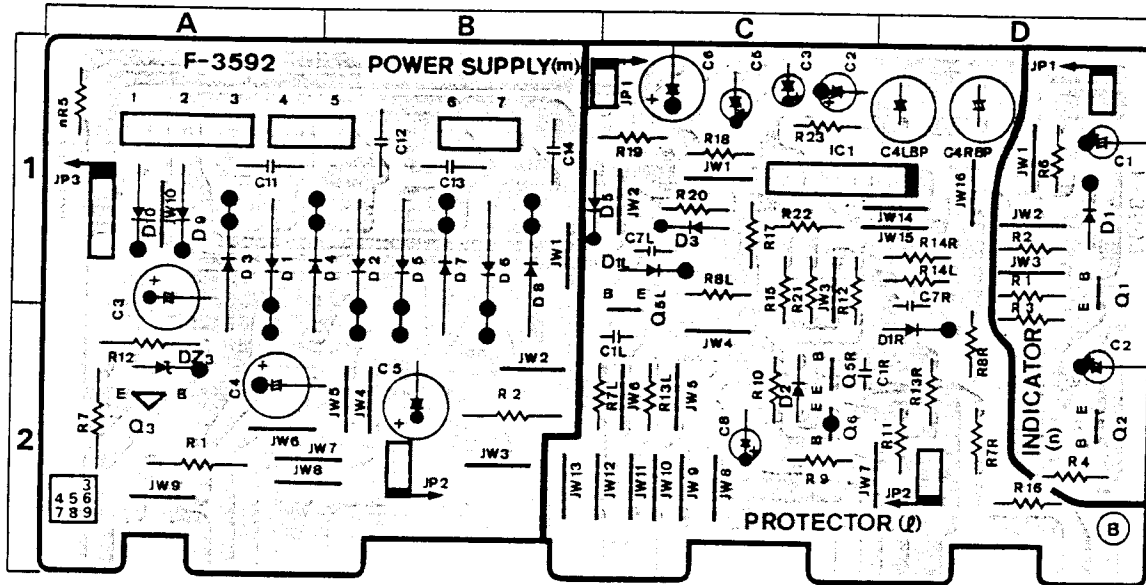

Parts List

Parts No.	Stock No.	Description
•IC		
iIC1	46207600	TA7317P
•Diode		
ID1 ~ 3	03117600	1S2473
ID5	03117600	1S2473
IC4	08460200	220μF 6.3V E.B.
•Transistor		
mQ3	03083902	2SD313
•Diode		
mD9, 10	03117700	10E-2
•Zener Diode		
mDZ3	03178800	RD12E-B
mR7	00184900	82Ω 1W N.I.R.
mC11 ~ 14	08680400	0.01μF 500V C.C.
•Transistor		
nQ1	03068301	2SC2320
	or 03059501	2SC945
nQ2	03068301	2SC2320
	or 03059501	2SC945

Parts No.	Stock No.	Description
•Diode		
nD1	03117600	1S2473
<AU-D33>		
•Transistor		
IQ5	03065501	2SC1775
	or 03067401	2SC1845
IQ6	03009301	2SA872
	or 03010901	2SA992
•Diode		
mD1 ~ 8	03115300	30D-2
<AU-D22>		
•Transistor		
IQ5	03067401	2SC1845
IQ6	03010901	2SA992
•Diode		
mD1 ~ 8	03117700	10E-2

2-3. F-3590 Power Amp Circuit Board (Stock No. 00656901 = AU-D33)

Component Side

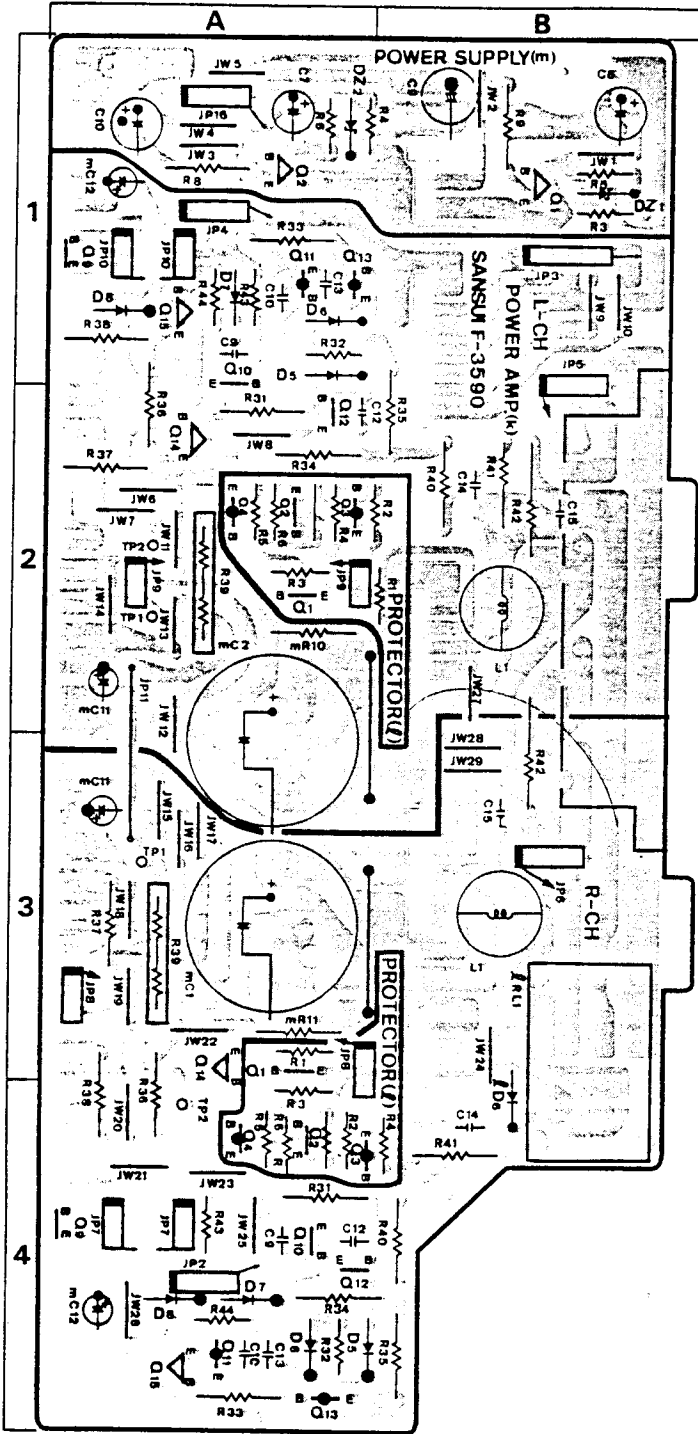

Parts List

Parts No.	Stock No.	Description
●Transistor		
kQ9	03068301	2SC2320
	or 03059501	2SC945
kQ10	03085201	2SD438
kQ11	03033601	2SB560MP
kQ12	07263501	2SD600
kQ13	07263401	2SB631
kQ14	03086101	2SD357
kQ15	03034401	2SB527
kQ16	46169901	2SC2579LBR
kQ17	46169801	2SA1104LBR
●Diode		
kD5	03117600	1S2473
kD6	03117600	1S2473
kR39	46184100	0.22Ω x 2 5W Ce.R.
kR42	00190600	4.7Ω 2W N.I.R.
kL1	46027200	1μH Inductor
●Transistor		
IQ1	03068301	2SC2320
	or 03059501	2SC945
	or 07194801	2SC1815
IQ2	03068301	2SC2320
	or 03059501	2SC945
	or 07194801	2SC1815
IQ3	03012701	2SA999
	or 07197001	2SA733A
	or 07194701	2SA1015
IQ4	03012701	2SA999
	or 07197001	2SA733A
	or 07194701	2SA1015
●Diode		
ID4	03117700	10E-2
IRL1	46152000	Relay
●Transistor		
mQ1	03085201	2SD438
mQ2	03033601	2SB560MP
●Zener Diode		
mDZ1	03180000	RD22E
mDZ2	03180000	RD22E
mC1	46151600	8200μF 50V E.C.
mC2	46151600	8200μF 50V E.C.
	46094600	8P Output Terminal

2-4. F-3589 Pre Drive Amp Circuit Board (Stock No. 00656801 = AU-D33)

Component Side

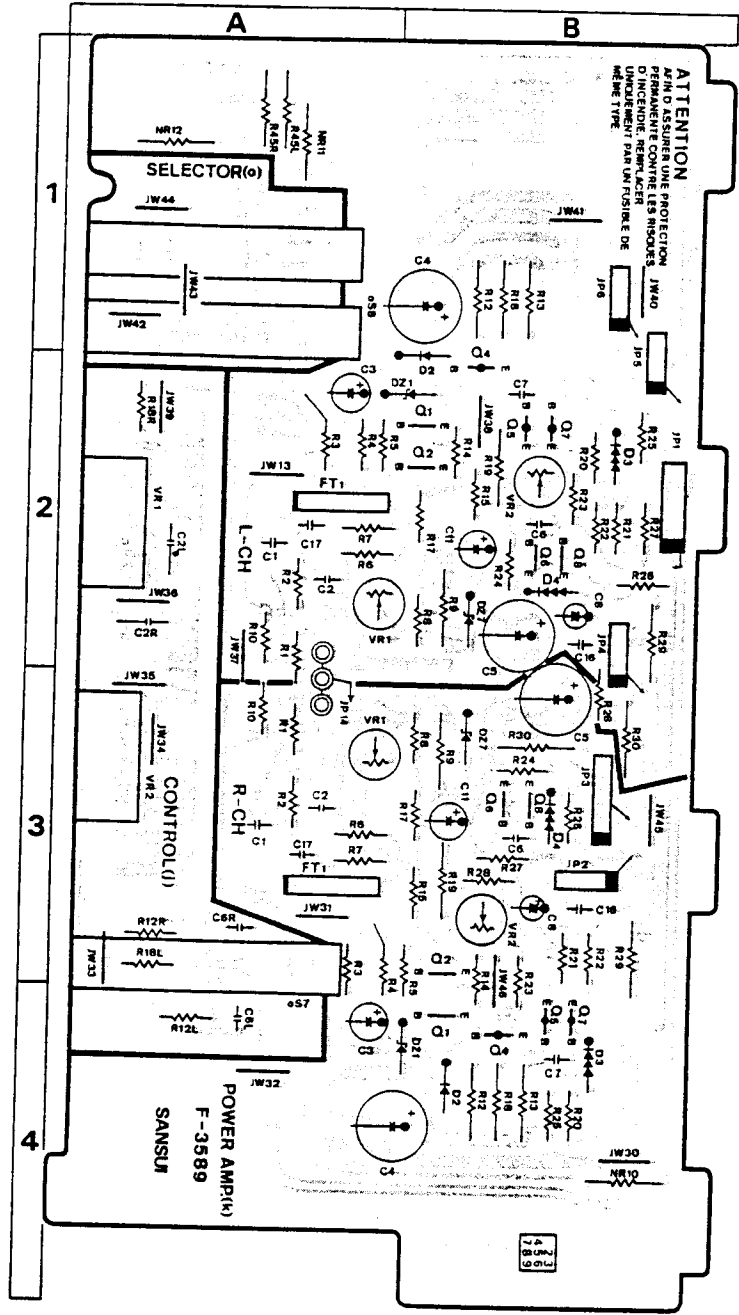

Parts List

Parts No.	Stock No.	Description
● Transistor		
kQ1	03067401	2SC1845
	or 07299101	2SC2240
kQ2	03067401	2SC1845
	or 07299101	2SC2240
kQ4	03010901	2SA992
	or 07299001	2SA970
kQ5	03010901	2SA992
	or 07299001	2SA970
kQ6	03067401	2SC1845
	or 07299101	2SC2240
kQ7	03007901	2SA899
kQ8	03064001	2SC1904
● FET		
kFT1	07110001	μPA68H
● Diode		
kD2	03117600	1S2473
● Varistor		
kD3	03401700	MV-103
kD4	03401700	MV-103
● Zener Diode		
kDZ1	03179600	RD18E-B
kDZ7	03180000	RD22E
kR45	00181200	220Ω 1W N.I.R.
kVR1	10350100	Semi Variable Resistor 100Ω (B), DC 0V
kVR2	10350700	Semi Variable Resistor 1kΩ (B), bias
oS7	46162100	Push Switch, tone selector
oS8	46161800	Push Switch, speaker A/B
oJ1	07204100	Head Phone Jack (Silver Model)
	46096600	Head Phone Jack (Black Model)
jVR1	46159800	Variable Resistor 50kΩ (C) x 2, bass
jVR2	46159800	Variable Resistor 50kΩ (C) x 2, treble

● Abbreviations

C.R.	Carbon Resistor	E.L.	Low Leak Electrolytic Capacitor
S.R.	Solid Resistor	E.B.	Bi-Polar Electrolytic Capacitor
Ca.R.	Cement Resistor	E.BL.	Low Leak Bi-Polar Electrolytic Capacitor
M.R.	Metal Film Resistor	Ta.C.	Tantalum Capacitor
F.R.	Fusing Resistor	F.C.	Film Capacitor
N.I.R.	Non-Inflammable Resistor	M.P.	Metalized Paper Capacitor
C.C.	Ceramic Capacitor	P.C.	Polystyrene Capacitor
C.T.	Ceramic Capacitor, Temperature Compensation	G.C.	Gimmic Capacitor
E.C.	Electrolytic Capacitor		

2-5. F-3594 Power Amp Circuit Board (Stock No. 00662601 = AU-D22)

Component Side

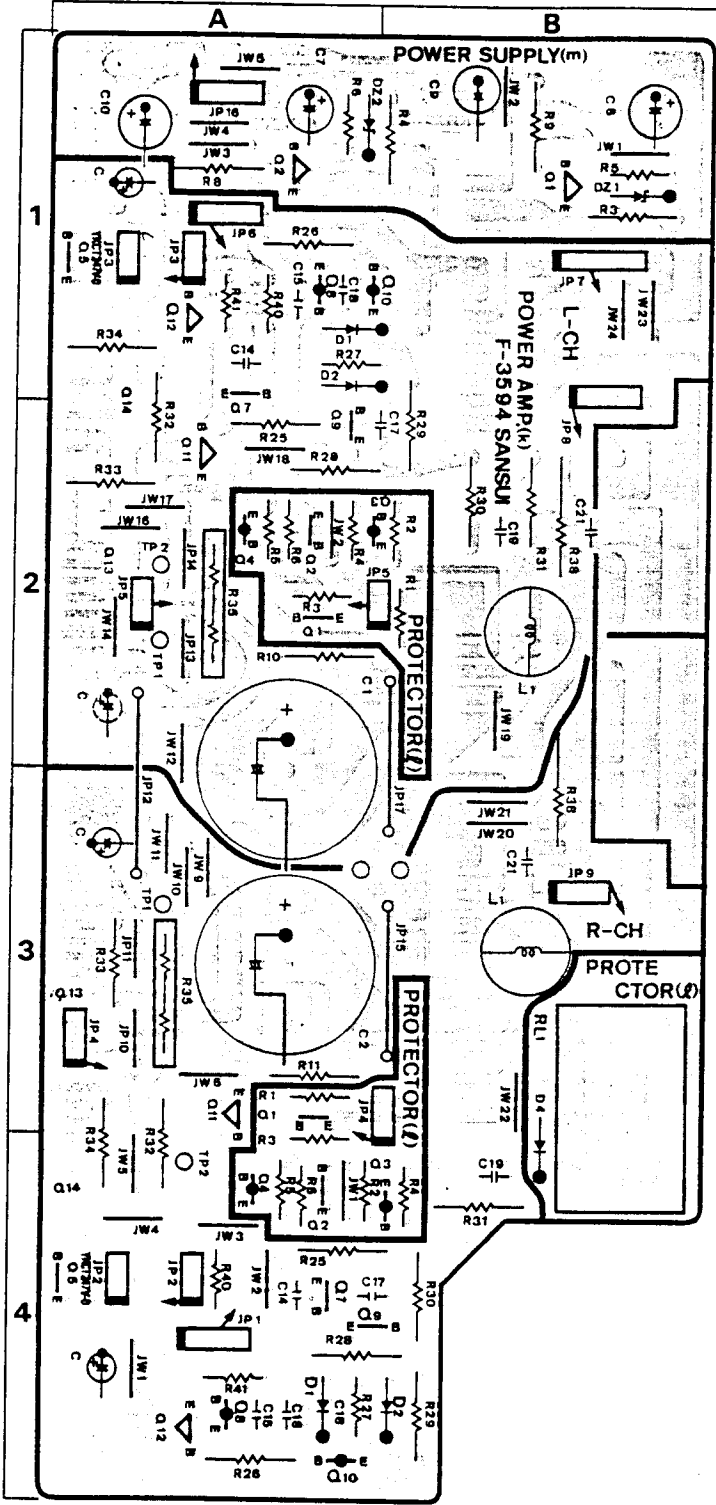

Parts List

Parts No.	Stock No.	Description
●Transistor		
kQ5	03068301	2SC2320
	or 07194801	2SC1815
	or 03059501	2SC945
kQ7	03062801	2SC1735
kQ8	03007201	2SA850
kQ9	07263501	2SD600
kQ10	07263401	2SB631
kQ11	03086101	2SD357
kQ12	03034401	2SB527
kQ13	46117901	2SC2577LBR
kQ14	46117801	2SA1102LBR
●Diode		
kD1, 2	03117600	1S2473
kR35	46184300	0.22Ω x 2 3W Ce.R.
kR38	00185500	10Ω 2W N.I.R.
kL1	46027200	Peaking Coil 1μH
●Transistor		
IQ1	03068301	2SC2320
	or 03059501	2SC945
	or 07194801	2SC1815
IQ2	03068301	2SC2320
	or 03059501	2SC945
	or 07194801	2SC1815
IQ3	03012701	2SA999
	or 07197001	2SA733A
	or 07194701	2SA1015
IQ4	03012701	2SA999
	or 07197001	2SA733A
	or 07194701	2SA1015
●Diode		
ID4	03117700	10E-2
IRL1	46152000	Relay
●Transistor		
mQ1	03085201	2SD438
mQ2	03033601	2SB560MP
●Zener Diode		
mDZ1, 2	03180000	RD22E-B
mC1, 2	00316100	6800μF 50V E.L.
	46094600	8P Output Terminal

2-6. F-3593 Pre Drive Amp Circuit Board (Stock No. 00662501 = AU-D22)

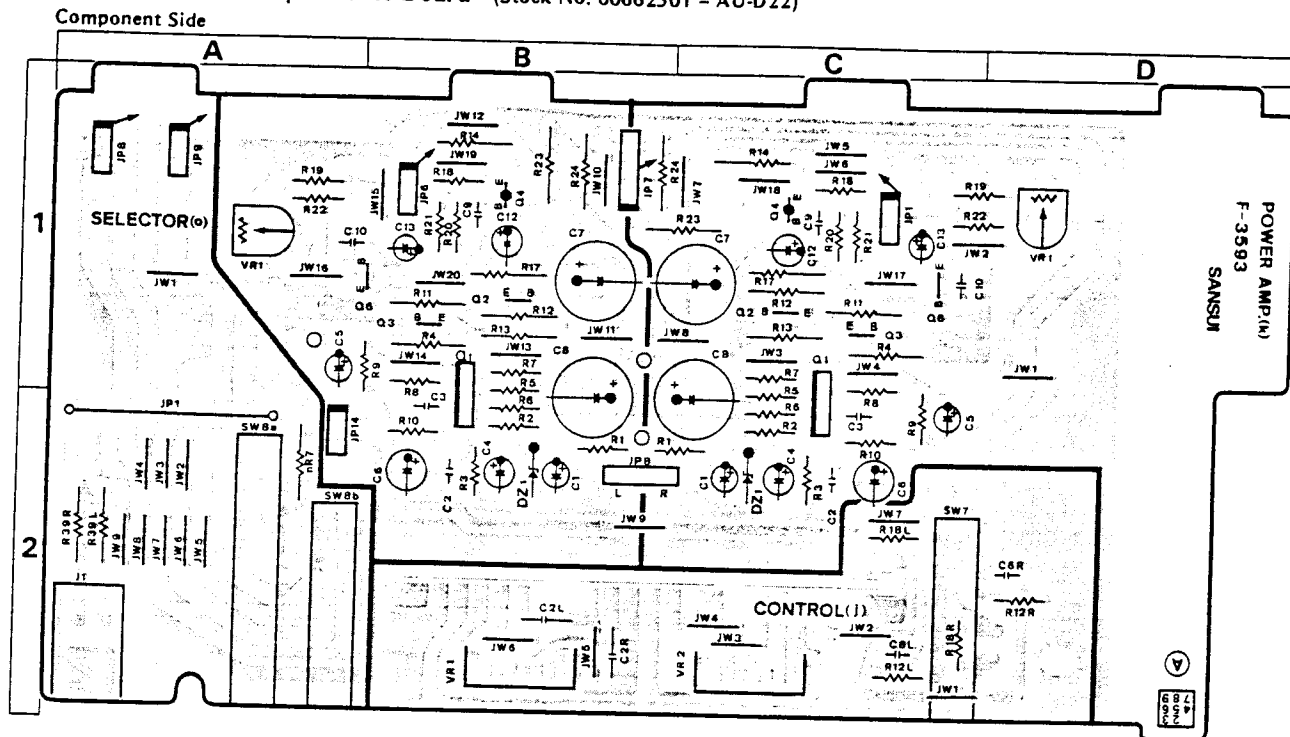

Parts List

Parts No.	Stock No.	Description
jVR1	46159800	Variable Resistor 50kΩ (C) x 2, bass
jVR2	46159800	Variable Resistor 50kΩ (C) x 2, treble
• Transistor		
kQ1	03602901	2SA798
kQ2	03062801	2SC1735
	or 46127901	2SC2910
kQ3	03062801	2SC1735
	or 46127901	2SC2910
kQ4	03007901	2SA899
kQ6	03064001	2SC1904

Parts No.	Stock No.	Description
• Zener Diode		
kDZ1	03179000	RD13E-B
kVR1	07240900	Semi Variable Resistor 500Ω (B), bias
oS7	11319501	Push Switch, tone
oS8	46162000	Push Switch, speaker A/B
oJ1	07204100	Head Phone Jack (Silver Model)
	46096600	Head Phone Jack (Black Model)

• Note: The circuit board, F-3580, F-3581, F-3583, F-3582, F-3591, F-3584, F-3334, F-3585, F-3579, F-3586 & F-3587 are not supplied as the assembled. However, the individual parts on the circuit board are provided by orders.

2-7. F-3580 Master Volume Circuit Board

Component Side

(AU-D33/D22)

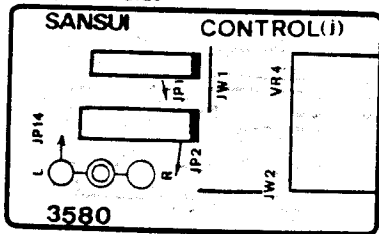

Parts List

Parts No.	Stock No.	Description
jVR4	46159900	Variable Resistor 150kΩ (B) x 2

2-8. F-3581 Input Terminal Circuit Board

Component Side

(AU-D33/D22)

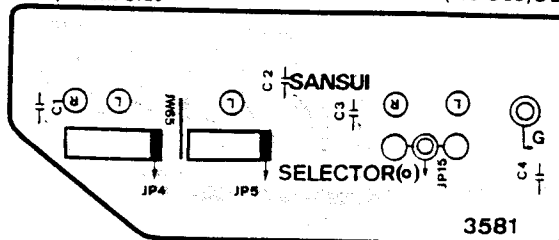

Parts List

Parts No.	Stock No.	Description
	07249000	2P Input Terminal, phono
	07249100	4P Input Terminal, tuner, aux

2-9. F-3583 Input Selector SW. Circuit Board (AU-D33/D22)

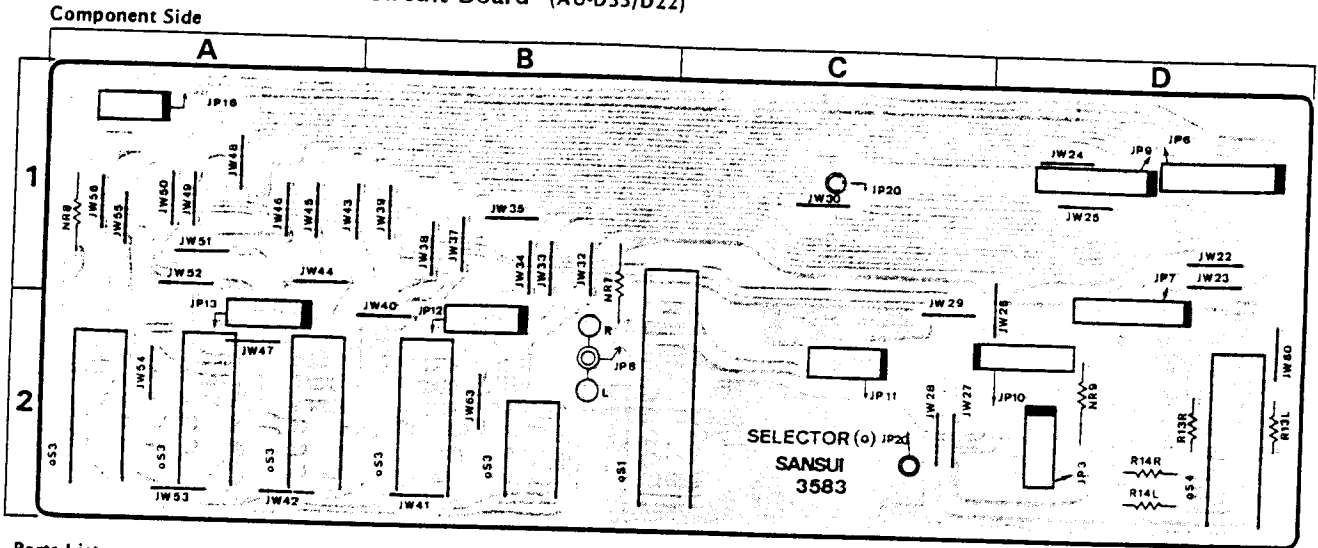

Parts List

Parts No.	Stock No.	Description
oS3	46162200	Push Switch, input selector
oS4	46161900	Push Switch, muting

Parts No.	Stock No.	Description
<AU-D33>		
oS1	46162300	Push Switch, MM/MC
<AU-D22>		
oS1	46162400	Push Switch, MM/MC

2-10. F-3582 Recording Selector Circuit Board (AU-D33/D22)

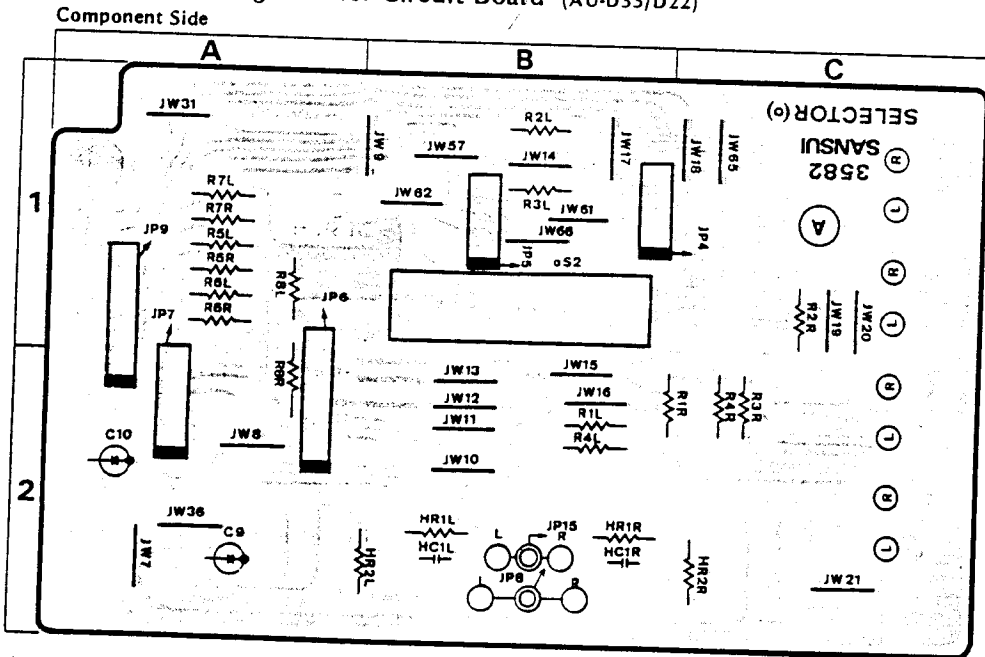

Parts List

Parts No.	Stock No.	Description
oS2	07200200	Rotary Slide Switch
	07249100	4P Input Terminal, tape 1, 2

3. OTHER PARTS

3-1. Front View

A) AU-D33

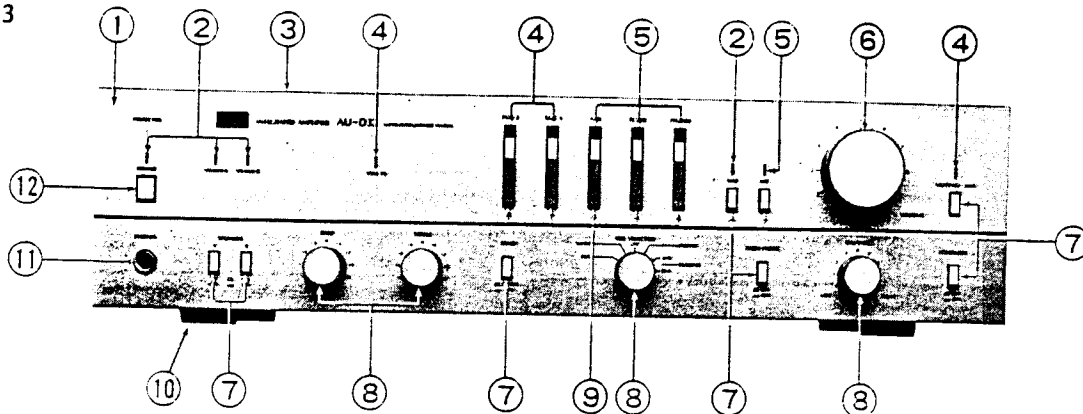

B) AU-D22

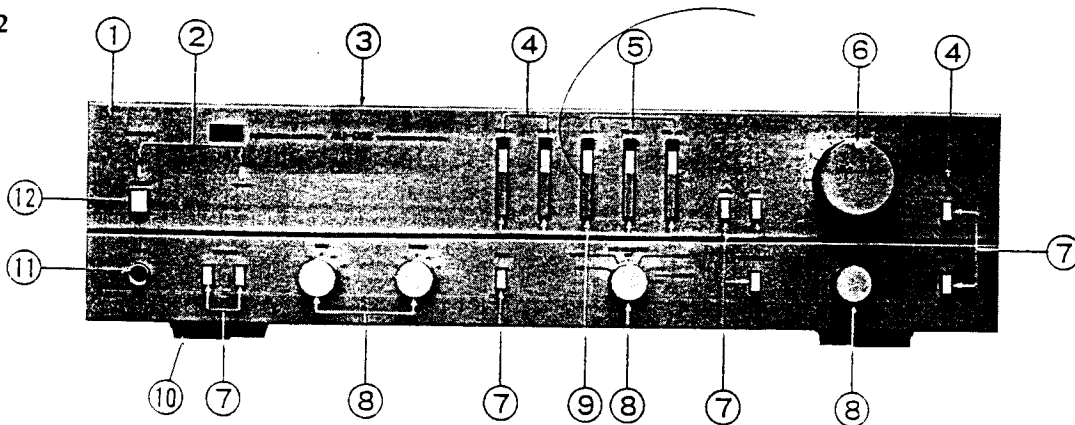

Parts List <Front View, AU-D33/D22>

Parts No.	Stock No.	Description
2	46169300	Light Emitting Diode SEL-1210S
4	46174000	Light Emitting Diode SLP-470C
5	46173900	Light Emitting Diode SLP-270C
10	07822700	Leg
<Silver Model>		
1	07814000	Front Panel Ass'y <AU-D33>
	07815800	Front Panel Ass'y <AU-D22>
3	07812000	Bonnet
6	07808900	Knob, volume
7	07809500	Push Knob, accessory
8	07808700	Knob, balance, bass, treble, rec selector
9	07809300	Push Knob, input selector
11	07204100	Head Phone Jack
12	07809700	Push Knob, power
<Black Model>		
1	07814100	Front Panel Ass'y <AU-D33>
	07815700	Front Panel Ass'y <AU-D22>
3	07812100	Bonnet
6	07809000	Knob, volume
7	07809600	Push Knob, accessory
8	07808800	Knob, balance, bass, treble, rec selector
9	07809400	Push Knob, input selector
11	46096600	Head Phone Jack
12	07809800	Push Knob, power

Parts List <Top View, AU-D33/D22>

Parts No.	Stock No.	Description
1	15005001	Power Transformer <AU-D33>
	15005101	Power Transformer <AU-D22>
2	39106000	Strain Relief
3	38004700	Power Supply Cord
4	07189600	AC Outlet
5	46094600	8P Output Terminal
6	22301500	Ground Terminal
7	07249000	2P Input Terminal, phono
8	07249100	4P Input Terminal, tuner, aux, tape
pF1	07188700	Fuse 125V 2A <AU-D33>
	07188500	Fuse 250V 1.5A <AU-D22>

3-2. Top View

A) AU-D33

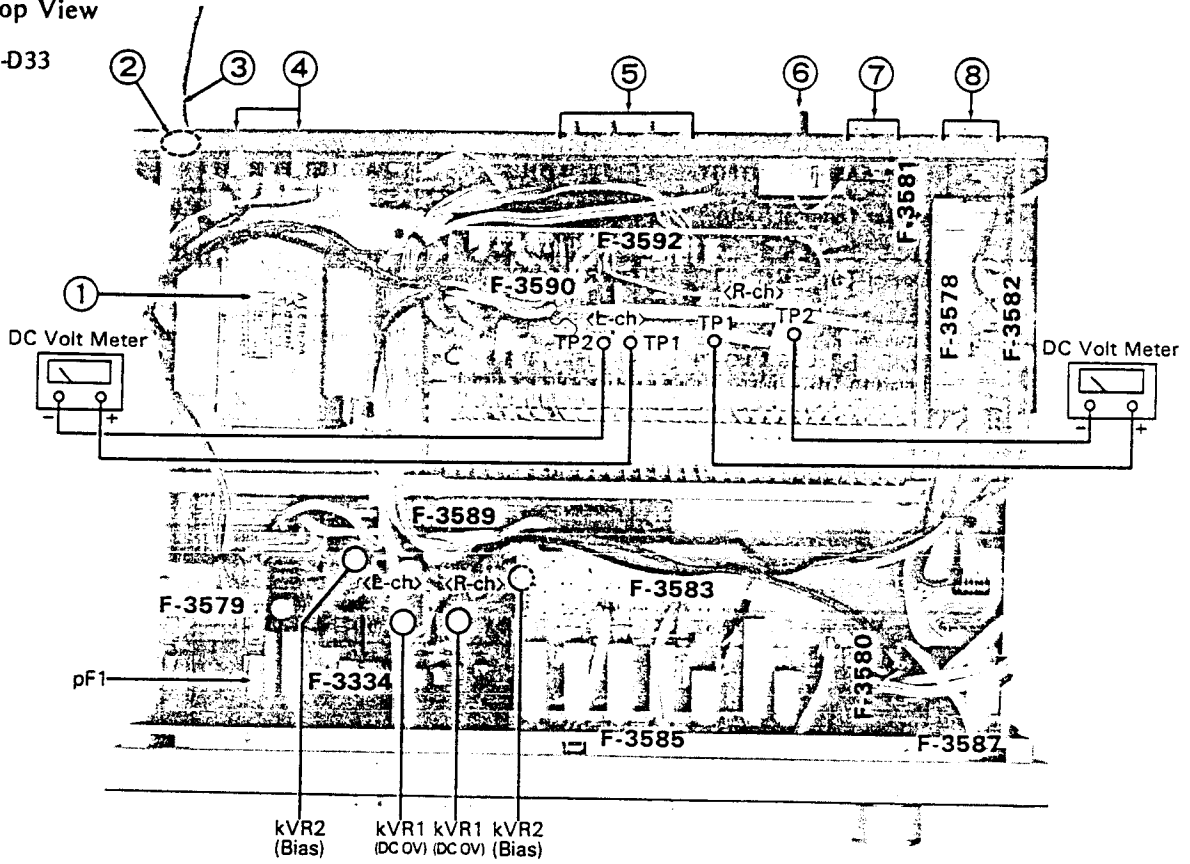

B) AU-D22

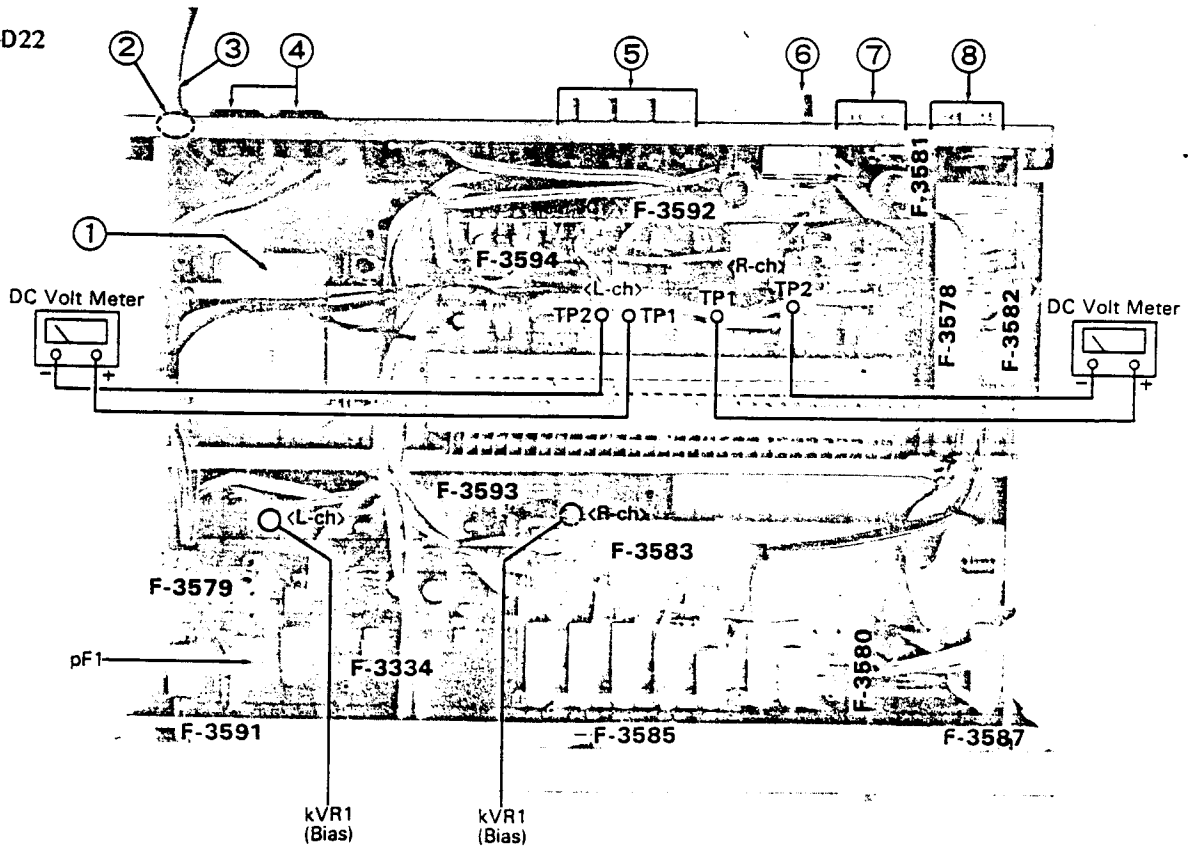

4. ADJUSTMENTS

4-1. Driver Circuit Adjustment (See Top View on page 10)

- Note: 1) Master Volume Minimum
 2) Room Temperature . . 18°C ~ 28°C (65°F ~ 83°F)

A) AU-D33

STEP	SUBJECT	MEASURE OUTPUT	ADJUST	ADJUST FOR	REMARKS
1.	DC 0V Adj. L-CH	Speaker Terminal (L-ch)	kVR1, L-ch (F-3589)	DC 0V ± 20 mV	Before turning ON power switch, set kVR1 (F-3589) to center position.
2.	DC 0V Adj. R-CH	Speaker Terminal (R-ch)	kVR1, R-ch (F-3589)	DC 0V ± 20 mV	
3.	Bias Current Adj. L-CH	Between emitters of power transistors (kQ16 & kQ17) (Between TP1 & 2)	kVR2, L-ch (F-3589) at 1 minute after turning the power ON.	DC 4 mV	<ul style="list-style-type: none"> • Before adjustment, the temperature of the transistors and the radiator must be same as room temperature. • Before turning ON power switch, set kVR2 (F-3589) fully counterclockwise.
4.	Bias Current Adj. R-CH	Between emitters of power transistors (kQ16 & kQ17) (Between TP1 & 2)	kVR2, R-ch (F-3589) at 1 minute after turning the power ON.	DC 4 mV	

B) AU-D22

STEP	SUBJECT	MEASURE OUTPUT	ADJUST	ADJUST FOR	REMARKS
1.	Bias Current Adj. L-CH	Between emitters of power transistors (kQ13 & kQ14) (Between TP1 & 2)	kVR1, L-ch (F-3593)	DC 4 mV	<ul style="list-style-type: none"> • Before adjustment, the temperature of the transistors and the radiator must be same as room temperature. • Before turning ON power switch, set kVR1 (F-3593) fully counterclockwise.
2.	Bias Current Adj. R-CH	Between emitters of power transistors (kQ13 & kQ14) (Between TP1 & 2)	kVR1, R-ch (F-3593)	DC 4 mV	

5. INTERIOR BLOCK DIAGRAM OF IC, TA7317P

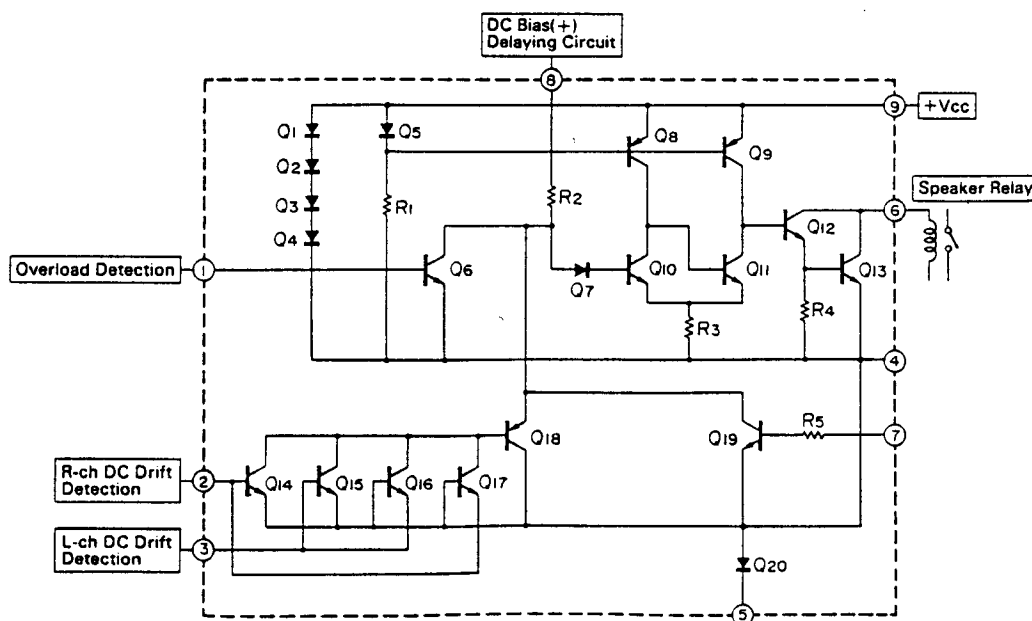

M 6-1. AU-D33

* Design and specifications subject to change without notice.
 * La présentation et les spécifications sont susceptibles d'être modifiées sans préavis.
 * Änderungen, die dem technischen Fortschritt dienen, vorbehalten.

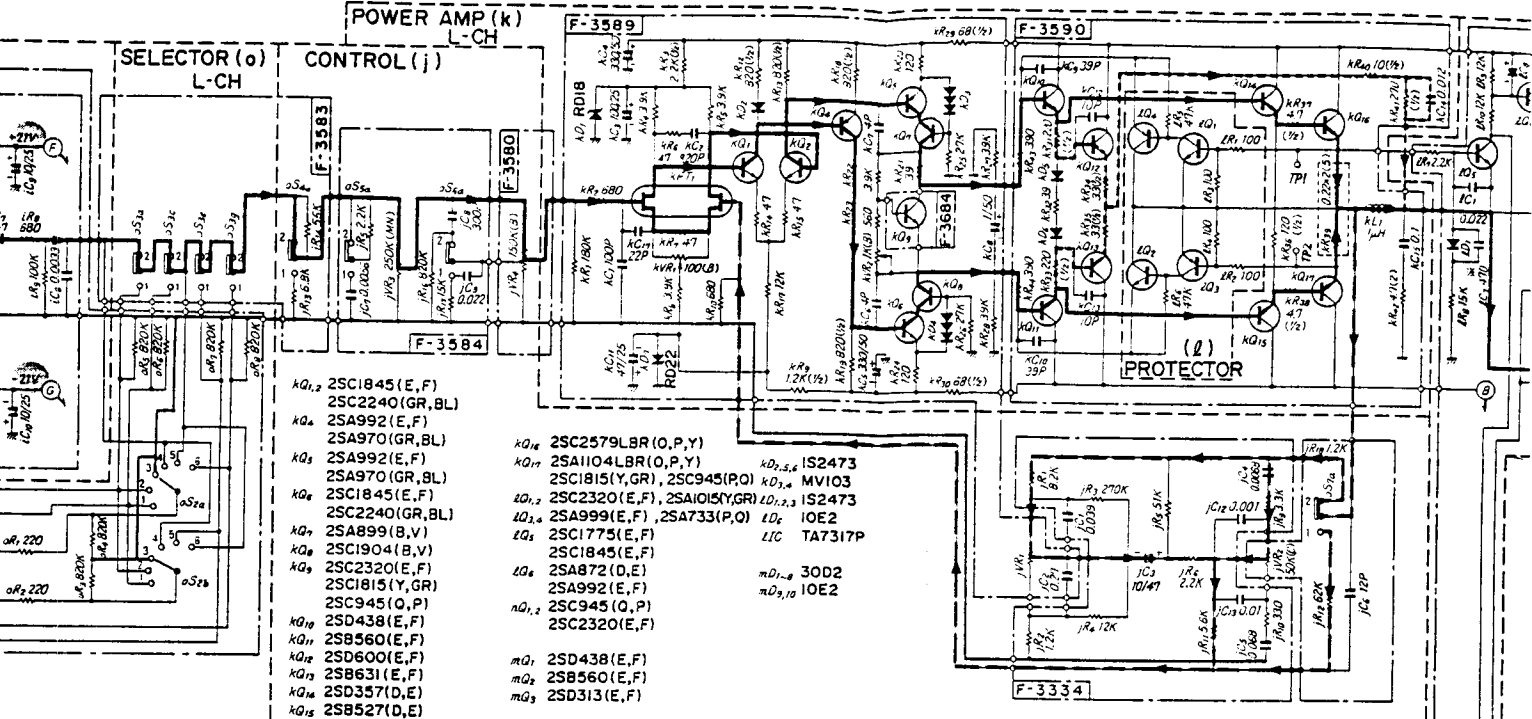

- | | |
|----------------------------------|--|
| KQ _{1,2} 2SC1845 (E,F) | KQ ₁₆ 2SC2579LBR (O,P,Y) |
| KQ ₃ 2SC2240 (GR, BL) | KQ ₁₇ 2SA1104LBR (O,P,Y) |
| KQ ₄ 2SA992 (E,F) | KD _{3,4} MVI03 |
| KQ ₅ 2SA970 (GR, BL) | KD _{5,6} IS2473 |
| KQ ₆ 2SC1845 (E,F) | KD _{7,8} 2SC2320 (E,F), 2SA1015 (Y, GR) |
| KQ ₇ 2SC2240 (GR, BL) | LD _{2,3} IS2473 |
| KQ ₈ 2SA899 (B, V) | LD _{1,4} 2SA999 (E,F), 2SA733 (P, Q) |
| KQ ₉ 2SC1904 (B, V) | LD ₅ IOE2 |
| KQ ₁₀ 2SC2320 (E,F) | LD ₆ LIC TA7317P |
| KQ ₁₁ 2SC1815 (Y, GR) | LD ₇ 30D2 |
| KQ ₁₂ 2SC945 (O, P) | LD ₈ IOE2 |
| KQ ₁₃ 2SD438 (E,F) | |
| KQ ₁₄ 2SB560 (E,F) | |
| KQ ₁₅ 2SD600 (E,F) | |
| KQ ₁₆ 2SB631 (E,F) | |
| KQ ₁₇ 2SD357 (D, E) | |
| KQ ₁₈ 2SB527 (D, E) | |

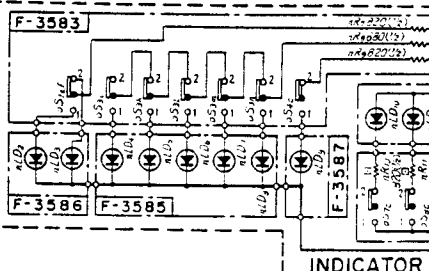
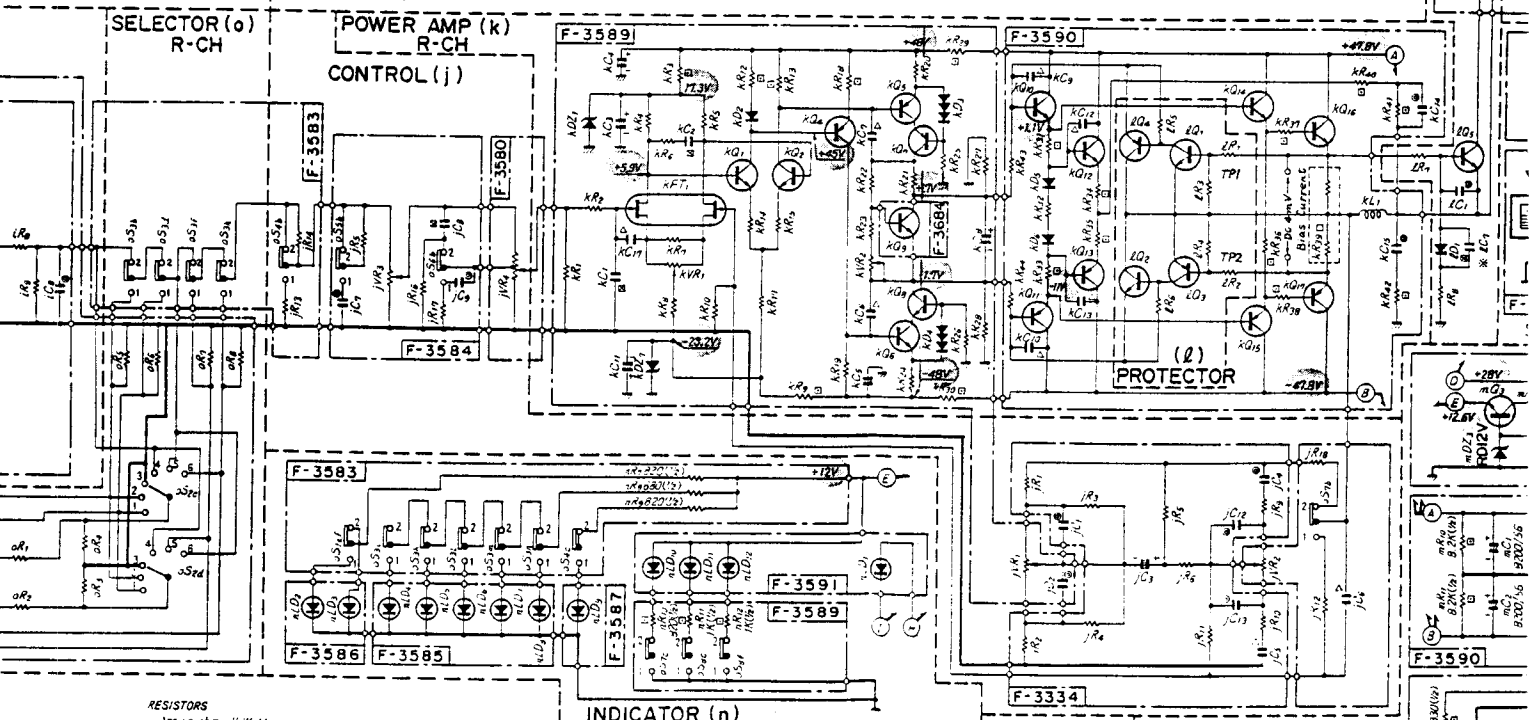

RESISTORS
 Are in ohms, 1/4 Watts.
 5% Tolerance
 Unless Otherwise Noted
 K: 1K, M: 1M

CAPACITORS
 Are in μ F, Unless Otherwise Noted, P: nF

TOLERANCE
 J: $\pm 5\%$, G: $\pm 2\%$, F: $\pm 1\%$
 Each D.C. Voltage shows the nominal value in volts at no input signal.
 Electrolytic Capacitor:
 Capacitance (μ F) / Volt (V)

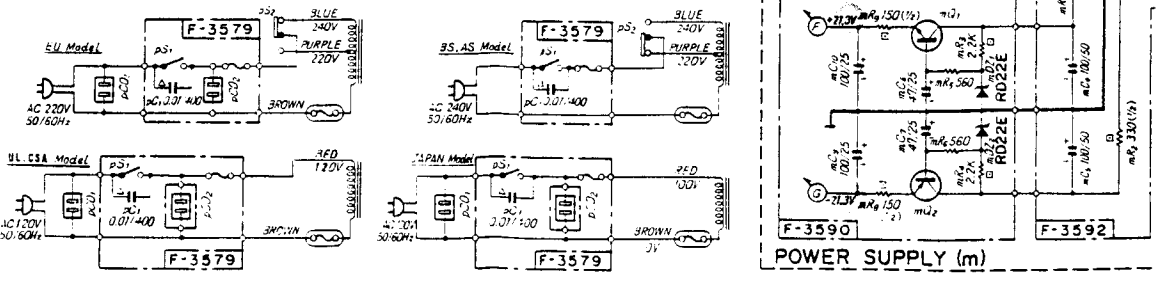

• Design and specifications subject to change without notice for improvement.
 • La présentation et les spécifications sont susceptibles d'être modifiées sans préavis par suites d'améliorations éventuelles.
 • Änderungen, die dem technischen Fortschritt dienen, bleiben vorbehalten.

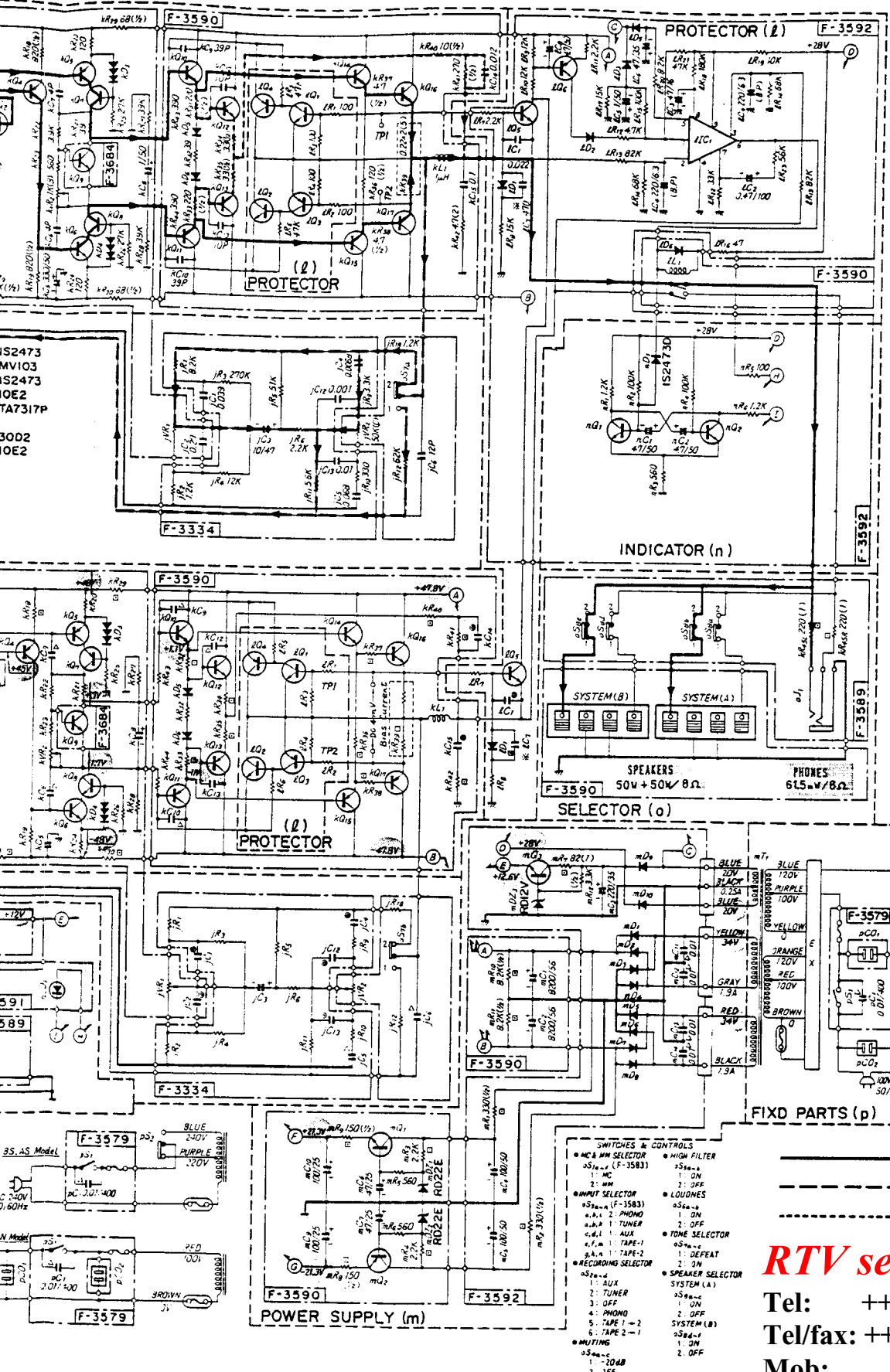

- 2SA733
- 2SA872
- 2SA870
- 2SA992
- 2SA1015
- 2SB560MP
- 2SC945
- 2SC1775
- 2SC1815
- 2SC1845
- 2SC2246
- 2SC2320
- 2SC438
- 2SA899
- 2SB631
- 2SC1904
- 2SD600
- 2SD357
- 2S8527
- 2SD313
- 2SA1104LBR
- 2SC2579LBR
- TA7317P
- NJM2043
- RD12E
- RD18E
- RD22E
- µPA68H
- 10E2
- IS2473
- MV-103

1
2
3
4

- SWITCHES & CONTROLS**
- MC/M SELECTOR (F-3583)
 - 1: ON
 - 2: OFF
 - INPUT SELECTOR (F-3583)
 - 1: PHONO
 - 2: TAPE-1
 - 3: TAPE-2
 - 4: TAPE-1-2
 - 5: TAPE-2-1
 - RECORDING SELECTOR (F-3583)
 - 1: ON
 - 2: OFF
 - TUNER (F-3583)
 - 1: ON
 - 2: OFF
 - TONE SELECTOR (F-3583)
 - 1: DEFEAT
 - 2: ON
 - 3: OFF
 - SPEAKER SELECTOR (F-3583)
 - 1: SYSTEM (A)
 - 2: SYSTEM (B)
 - MUTE (F-3583)
 - 1: ON
 - 2: OFF

— Signal Line
 - - - N.F.B. Line
 ····· F.F. Line

RTV servis Horvat
 Tel: ++385-31-856-637
 Tel/fax: ++385-31-856-139
 Mob: 098-788-319

A

B

C

D

6-2. AU-D22

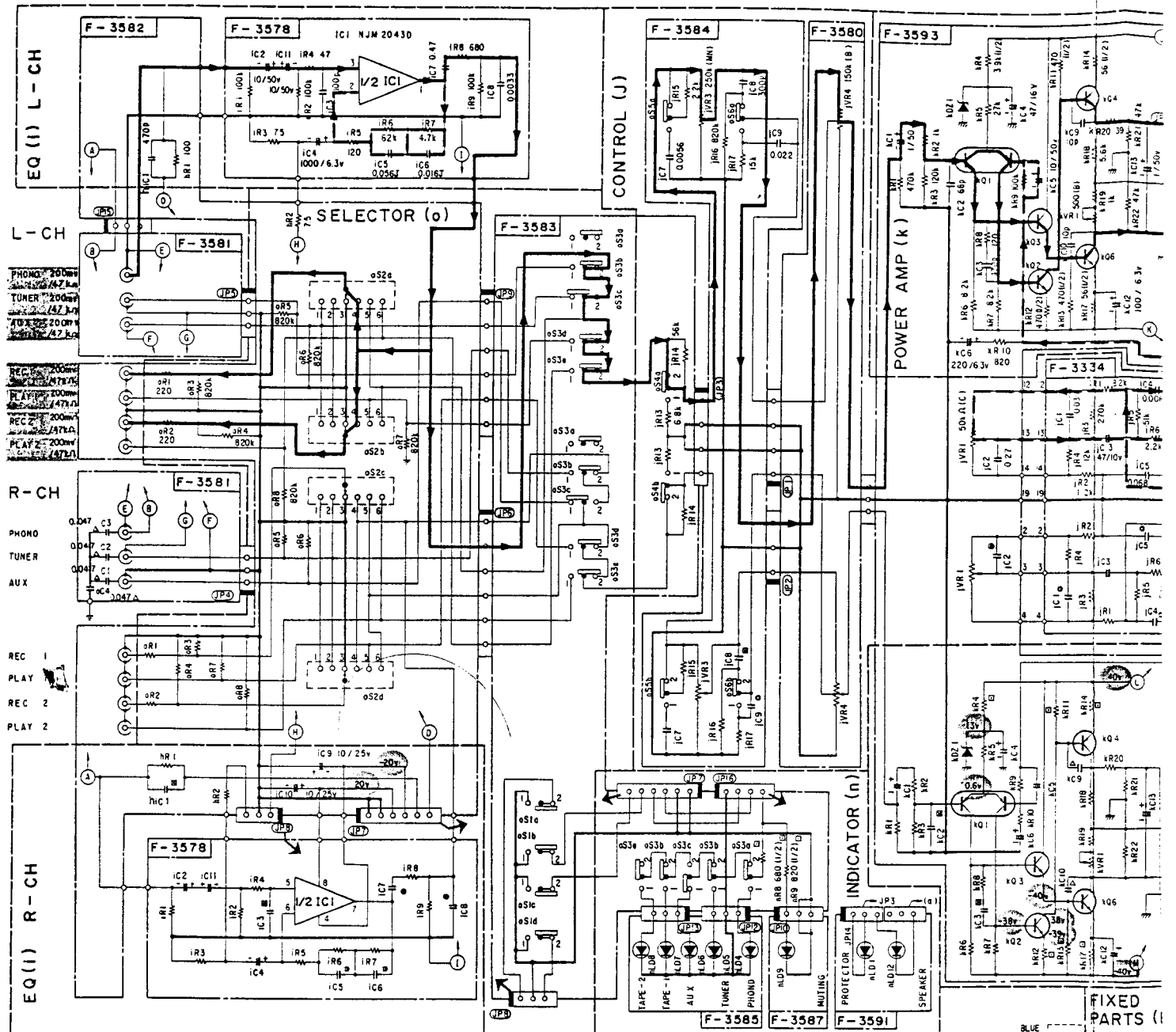

P/W B NO	PARTS NO	TRANSISTOR	OPTIONAL USE FOR TRANSISTOR
F-3592	Q1,2	2SC2320	E.F. 2SC1815 2SC945
	Q3	2S0313	
	Q5	2SC1845	F.E.
	Q6	2SA992	F.E.
F-3593	X1	2SA798	F.G.
	X2,3	2SC1735	GR BL 2SC2910
F-3685	X6	2SA899	B.V.
	X5	2SC1904	B.V.
F-3594	X7	2SC2320	E.F. 2SC945 2SC1815
	X8	2SC1735	D.E.
	X9	2SA850	D.E.
	X10	2S0600	E.F.
	X11	2S8631	E.F.
	X12	2S0357	D.E.
	X13	2S8527	D.E.
	X14	2SC2577	LBR
	X15	O.P.Y.	
	X16	2SA1102	LBR
	X17	O.P.Y.	
	X18	2SD438	E.F.
	X19	2S8560	E.F.
X20	2SC2320	E.F. 2SC945 2SC1815	
X21	2SA999	E.F. 2SA733 2SA1015	

P/W B NO	PARTS NO	DIODE	LED
F-3592	D1,2,3,5	1S2473 D	
	D4	1S2473 D	
	D10	1OE-2	
	D12	RD12E-8	
F-3593	D1	RD13E-8	
	D1,2	1S2473 D	
F-3594	D1,2	RD22E-9	
	D1,2	SLP-260C	
F-3585	D1,2	SLP-460C	
	D1,2	SLP-460C	
F-3591	D1,12	SEL-1210S	

- SWITCHES & CONTROLS**
- MC & MM SELECTOR
 - 1: MC
 - 2: MM
 - INPUT SELECTOR
 - a: PHONO
 - b: TUNER
 - c: AUX
 - d: TAPE - 1
 - e: TAPE - 2
 - RECORDING SELECTOR
 - 1: AUX
 - 2: TUNER
 - 3: OFF
 - 4: PHONO
 - 5: TAPE 1 - TAPE 2
 - 6: TAPE 2 - TAPE 1
 - MUTING
 - 1: -20dB
 - 2: OFF
 - LOUDNES
 - 1: ON
 - 2: OFF
 - HIGH FILTER
 - 1: ON
 - 2: OFF
 - TONE SELECTOR
 - 1: DEFEAT
 - 2: ON
 - SPEAKER SELECTOR
 - 1: ON
 - 2: OFF
 - SYSTEM
 - 1: ASYSTEM
 - 2: BSYSTEM

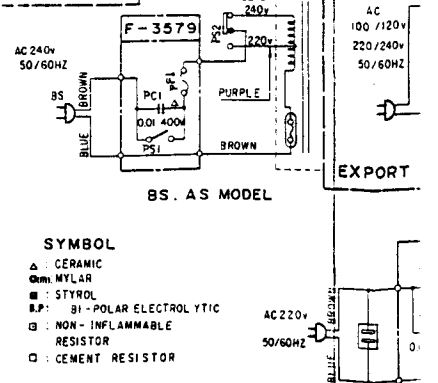

- SYMBOL**
- △: CERAMIC
 - : MYLAR
 - : STYROL
 - BP: BI-POLAR ELECTROLYTIC
 - : NON-INFLAMMABLE RESISTOR
 - : CEMENT RESISTOR

* Design and specifications subject to change w
 * La présentation et les spécifications sont suscep
 * Änderungen, die dem technischen Fortschritt

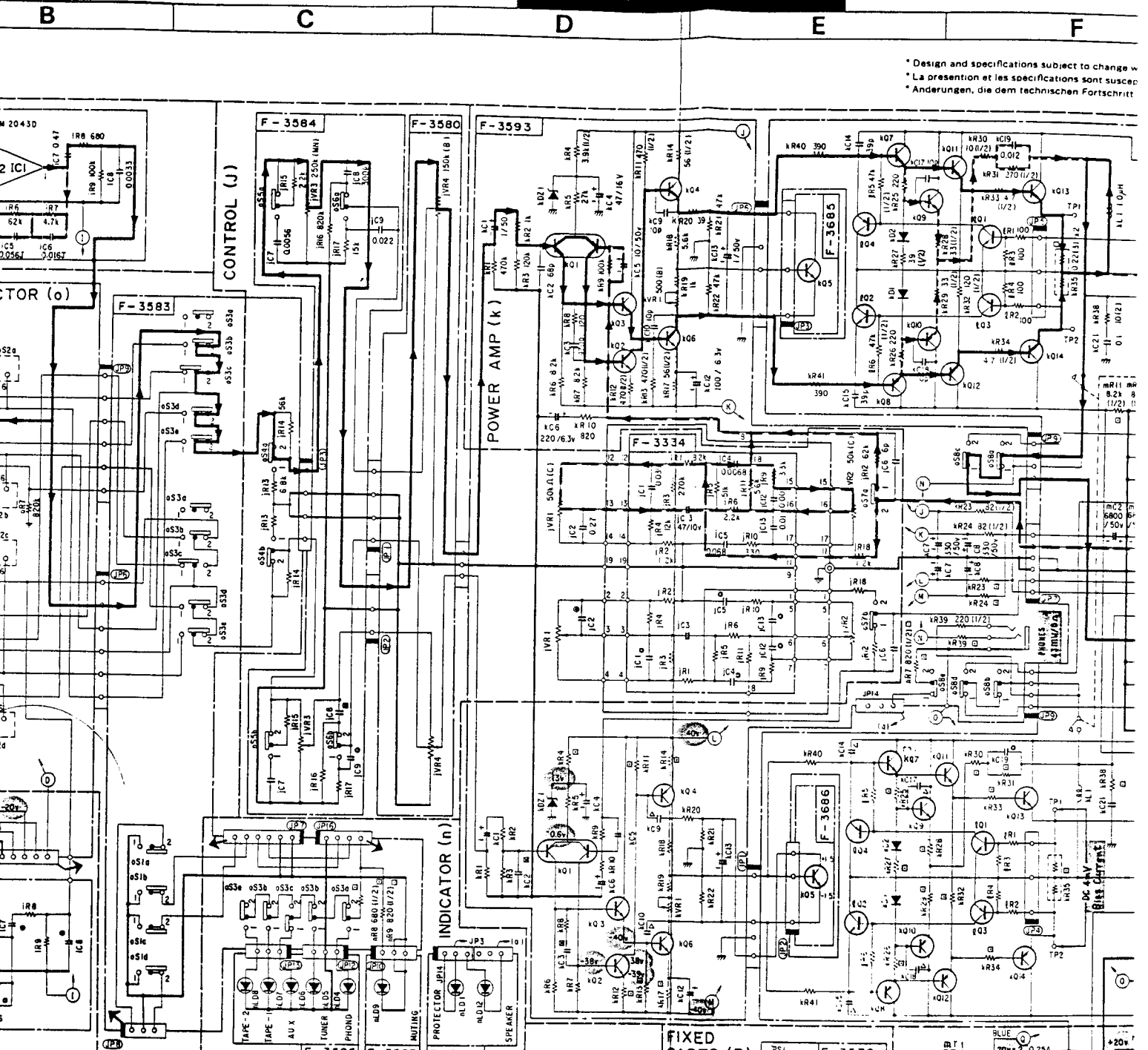

NO	PARTS	NO	LEO
15	RD 4, 3, 6	SLP-260C	
16	RD 7, 8	SLP-460C	
17	RD 9	SLP-460C	
19	RD 1, 12	SEL-1210S	

- ### SWITCHES & CONTROLS
- MC & MM SELECTOR
 - oS1a-d (F-3583)
 - 1: MC
 - 2: MM
 - INPUT SELECTOR
 - oS3a-b (F-3583)
 - a: PHONO
 - b: TUNER
 - c: AUX
 - d: TAPE - 1
 - e: TAPE - 2
 - RECORDING SELECTOR
 - oS2a-d
 - 1: AUX
 - 2: TUNER
 - 3: OFF
 - 4: PHONO
 - 5: TAPE 1 - TAPE 2
 - 6: TAPE 2 - TAPE 1
 - MUTING
 - oS4a-b
 - 1: -20dB
 - 2: OFF
 - LOUDNES
 - oS5a-b
 - 1: ON
 - 2: OFF
 - HIGH FILTER
 - oS6a-b
 - 1: ON
 - 2: OFF
 - TONE SELECTOR
 - oS7a-b
 - 1: DEFEAT
 - 2: ON
 - SPEAKER SELECTOR
 - oS8a, b, c
 - 1: ASYSTEM
 - 2: BSYSTEM

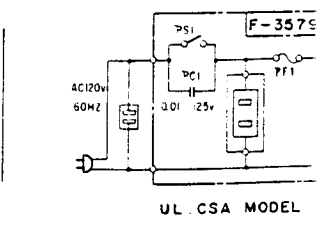
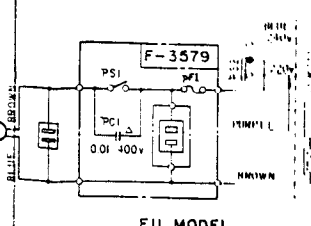
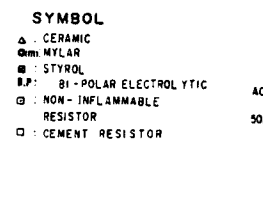
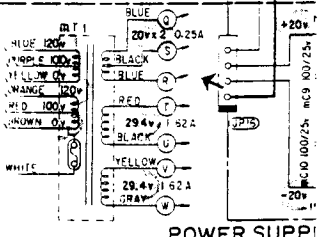
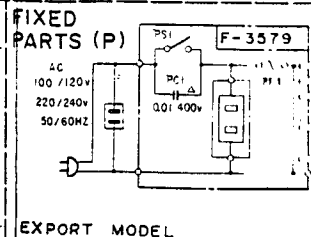
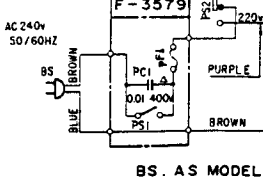

RTV servis Horvat
 Tel: ++385-31-856-637
 Tel/fax: ++385-31-856-139
 Mob: 098-788-319
www.rtv-horvat-dj.hr

• Design and specifications subject to change without notice for improvement.
 • La présentation et les spécifications sont susceptibles d'être modifiées sans préavis par suites d'améliorations éventuelles.
 • Änderungen, die dem technischen Fortschritt dienen, bleiben vorbehalten.

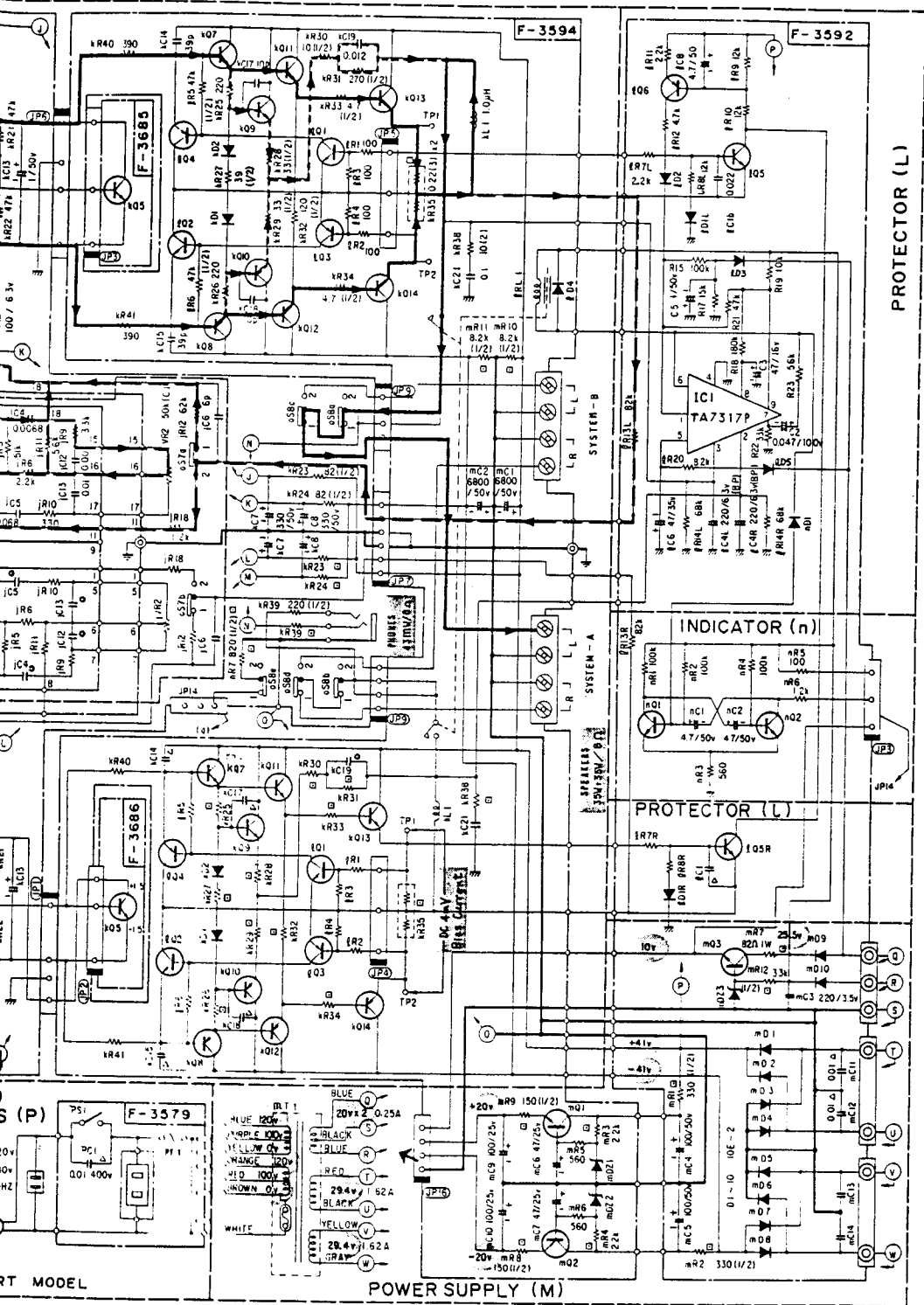

- 2SA992
- 2SA999
- 2SA1015
- 2SA-733A
- 2SB560MP
- 2SC945
- 2SC1815
- 2SC1845
- 2SC2320
- 2SC2910
- 2SD438
- 2SA850
- 2SC1735
- 2SA899
- 2SB631
- 2SC1904
- 2SD600

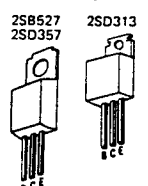
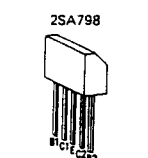

- 2SA1102LBR
- 2SC2577LBR

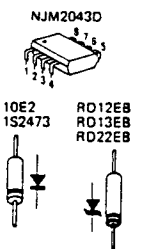
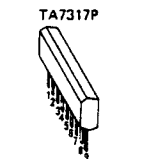
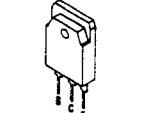

1
2
3
4

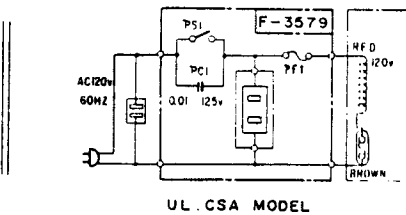
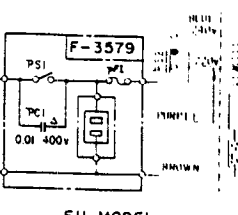

RESISTORS
 ARE IN OHMS 1/4 WATTS ±5% TOLERANCE
 UNLESS OTHERWISE NOTED. K: KO Ω W: MW
 CAPACITORS
 ARE IN μF UNLESS OTHERWISE NOTED. P: PF
 TOLERANCE
 J: ±5% G: ±2% F: ±1%
 EACH D.C. VOLTAGE SHOWS THE NOMINAL VALUE
 IN VOLTS AT NO INPUT SIGNAL
 ELECTROLYTIC CAPACITOR CAPACITANCE (μF)/VOLT (V)

— Signal Line
 - - - N.F.B. Line
 ····· F.F. Line

7. PACKING LIST

•AU-D33

Parts No.	Stock No.	Description
1	91167810	Vinyl Cover
2	07811900	Styrofoam Packing
3	07811100	Carton Case (Silver Model)
	07810900	Carton Case (Black Model)

•AU-D22

Parts No.	Stock No.	Description
1	91167810	Vinyl Cover
2	07811900	Styrofoam Packing
3	07811300	Carton Case (Silver Model)
	07811200	Carton Case (Black Model)

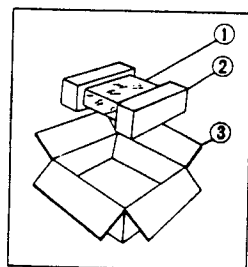

8. ACCESSORY LIST

•AU-D33

Stock No.	Description
46125300	Operating Instruction

•AU-D22

Stock No.	Description
46141700	Operating Instruction



SERVICE BULLETIN

SANSUI ELECTRIC COMPANY LIMITED 9-16 SHIMORENJAKU 8CHOME, MITAKA-CITY, TOKYO 181, JAPAN PHONE:0422 (48) 7211
Quality Assurance Dept.

MODEL: AU-D33
Integrated Amplifier

Ref. AN-139
Date: November '81

SUBJECT: HUM NOISE AT MC PHONO

Symptom:

When turning up volume control, hum noise in some sets may occur at MC PHONO position.

Countermeasure:

Interchange two wirings, white lead with pink one on F-3582 board as shown below.

NOTE:

This bulletin applies to all #AU-D33 with Serial No. between 431100001 & 431100300.

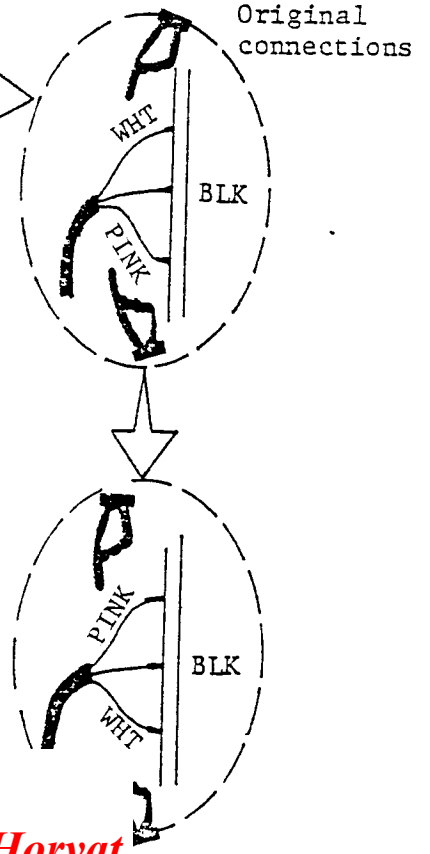
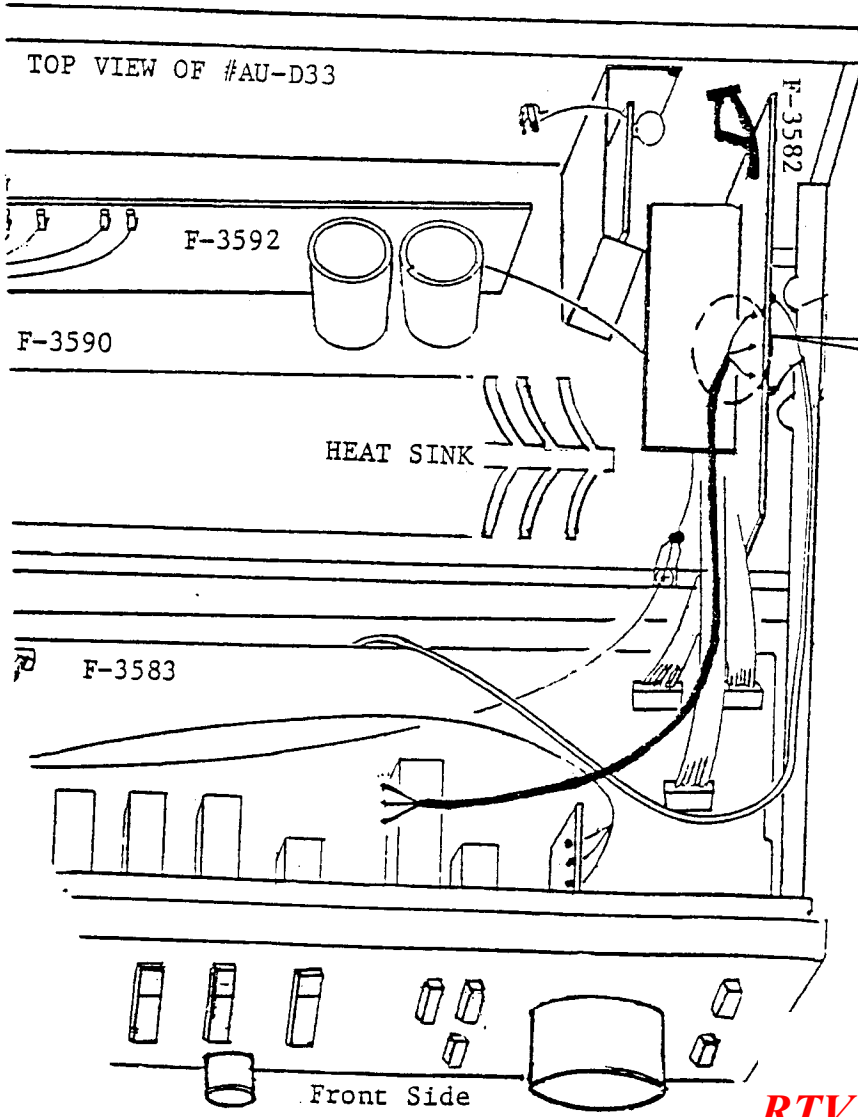
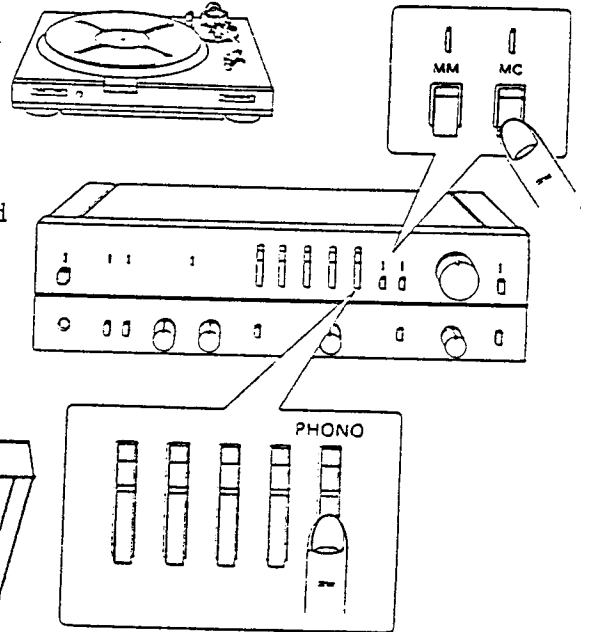

RTV servis Horvat

Tel: ++385-31-856-637

Tel/fax: ++385-31-856-139

Mob: 098-788-319

www.rtv-horvat-dj.hr

www.rtv-horvat-dj.hr