

**HiFi ENGINE<sup>®</sup>**

For more Hi-Fi manuals and set-up information  
please visit [www.hifiengine.com](http://www.hifiengine.com)

SERVICE  
MANUAL



**marantz**

model 170DC

*Power Amplifier*

## TABLE OF CONTENTS

SECTION	PAGE
<b>1. INTRODUCTION</b> .....	<b>1</b>
<b>2. TEST EQUIPMENT REQUIRED FOR SERVICING</b> .....	<b>1</b>
<b>3. ALIGNMENT PROCEDURE</b> .....	<b>2</b>
3.1 DC Balance .....	<b>2</b>
3.2 Meter Adjustment .....	<b>2</b>
<b>4. VOLTAGE CONVERSION FOR EUROPE</b> .....	<b>2</b>
4.1 Voltage Conversion Chart for Europe .....	<b>2</b>
<b>5. MAJOR COMPONENT LOCATIONS</b> .....	<b>3</b>
5.1 Front Panel Adjustment and Component Locations .....	<b>3</b>
5.2 Main Chassis Component Locations (Top View) .....	<b>3</b>
5.3 Rear Panel Adjustment and Component Locations .....	<b>4</b>
5.4 Main Chassis Component Locations (Bottom View) .....	<b>4</b>
5.5 Front Panel Adjustment and Component Locations for Europe .....	<b>5</b>
5.6 Main Chassis Component Locations (Top View) .....	<b>5</b>
5.7 Rear Panel Adjustment and Component Locations for Europe .....	<b>6</b>
5.8 Main Chassis Component Locations (Bottom View) .....	<b>6</b>
<b>6. DIAGRAM AND COMPONENT LOCATIONS</b> .....	<b>7</b>
6.1 Main Amp. Assembly (P700) Schematic Diagram and Component Locations .....	<b>7</b>
6.2 Peak Indicator Assembly (PN00) Schematic Diagram and Component Locations .....	<b>8</b>
<b>7. BLOCK DIAGRAM</b> .....	<b>9</b>
<b>8. PACKING MATERIAL EXPLODED VIEW</b> .....	<b>10</b>
<b>9. CONNECTION DIAGRAM</b> .....	<b>11</b>
<b>10. SCHEMATIC DIAGRAM</b> .....	<b>13</b>
<b>11. EXPLODED MECHANICAL DIAGRAM</b> .....	<b>15</b>
<b>12. PARTS LIST</b> .....	<b>17</b>
<b>13. TECHNICAL SPECIFICATIONS</b> .....	<b>21</b>

## 1. INTRODUCTION

This service manual was prepared for use by Authorized Warranty Stations and contains service information for Marantz Model 170DC Main Amplifier.

Servicing information and voltage data included in this manual are intended for use by the knowledgeable and experienced technician only. All instructions should be read carefully. No attempt should be made to proceed

without a good understanding of the operations in the receiver.

The parts list furnishes information by which replacement parts may be ordered from the Marantz Company. A simple description is included for parts which can usually be obtained through local suppliers.

## 2. TEST EQUIPMENT REQUIRED FOR SERVICING

Table 1 lists the test equipment required for servicing the Model 170DC Main Amplifier.

Item	Manufacturer and Model No.	Use
Distortion Analyzer Audio Oscillator AC VTVM	Sound Technology Model 1700B	Distortion measurements Sinewave and squarewave signal source voltage measurements (AC)
Oscilloscope	Tektronix Model T932 Philips Model 3232	Waveform analysis and trouble shooting and ASO alignment
Circuit Tester		Trouble shooting
DC VTVM	Fluke Model 8000 "Digital" Simpson Model 313, Triplet Model 801	Voltage measurements (DC)
AC Wattmeter	Simpson Model 1379	Monitors primary power to amplifier
AC Ammeter	Commercial Grade (1-10A)	Monitors amplifier output under short circuit condition
Line Voltmeter	Simpson Model 1359	Monitors potential of primary power to amplifier
Variable Autotransformer	Superior Electronic Co., Powerstat Model 116B-10A	Adjusts level of primary power to amplifier
Shorting Plug	Use phono plug with 600 ohm across center pin and shell	Shorts amplifier input to eliminate noise pickup
Output Load (8 ohms, ± 0.5% 100W)	Commercial Grade	Provides 8-ohm load for amplifier output termination
Output Load (4 ohms, ± 0.5% 100W)	Commercial Grade	Provides 4-ohm load for amplifier output termination

### 3. ALIGNMENT PROCEDURE

#### 3.1 DC BALANCE

1. Connect oscilloscope to Left Channel output terminals of the Model 170DC.
2. Turn Line Switch to ON and adjust variac to 120 vac.
3. After relay energizes, adjust Left Channel (Left Hand Heatsink) amplifier board potentiometer R719 for an indication of a "line" zero (i.e.,  $0V \pm 50 mV$ ) as indicated on the oscilloscope.
4. Repeat for Right Channel (Right Hand Heatsink).

#### 3.2 METER ADJUSTMENT

1. Fully turn RN03 (RN04) clockwise and RN11 (RN12) counterclockwise.
2. Set the output of the speaker terminal to 9V R.M.S.
3. Set the meters (M001, M002) to "0VU" by RN11 (RN12).
4. Increase the output of the speaker terminal to 16V R.M.S.  
Turn RN03 (RN04) in the clockwise direction and stop where the meter's pointer hits the full scale stopper.

#### • EUROPEAN MODEL ONLY

### 4. VOLTAGE CONVERSION

This Model is equipped with a universal power transformer to permit operation at 110, 120, 220 and 240 V AC 50/60 Hz.

To convert the unit to the required voltage, set the plug as illustrated so that you can adjust the voltage as required.

#### CAUTION

DISCONNECT POWER SUPPLY CORD FROM AC OUTLET BEFORE CONVERTING VOLTAGE.

#### 4.1 VOLTAGE CONVERSION CHART

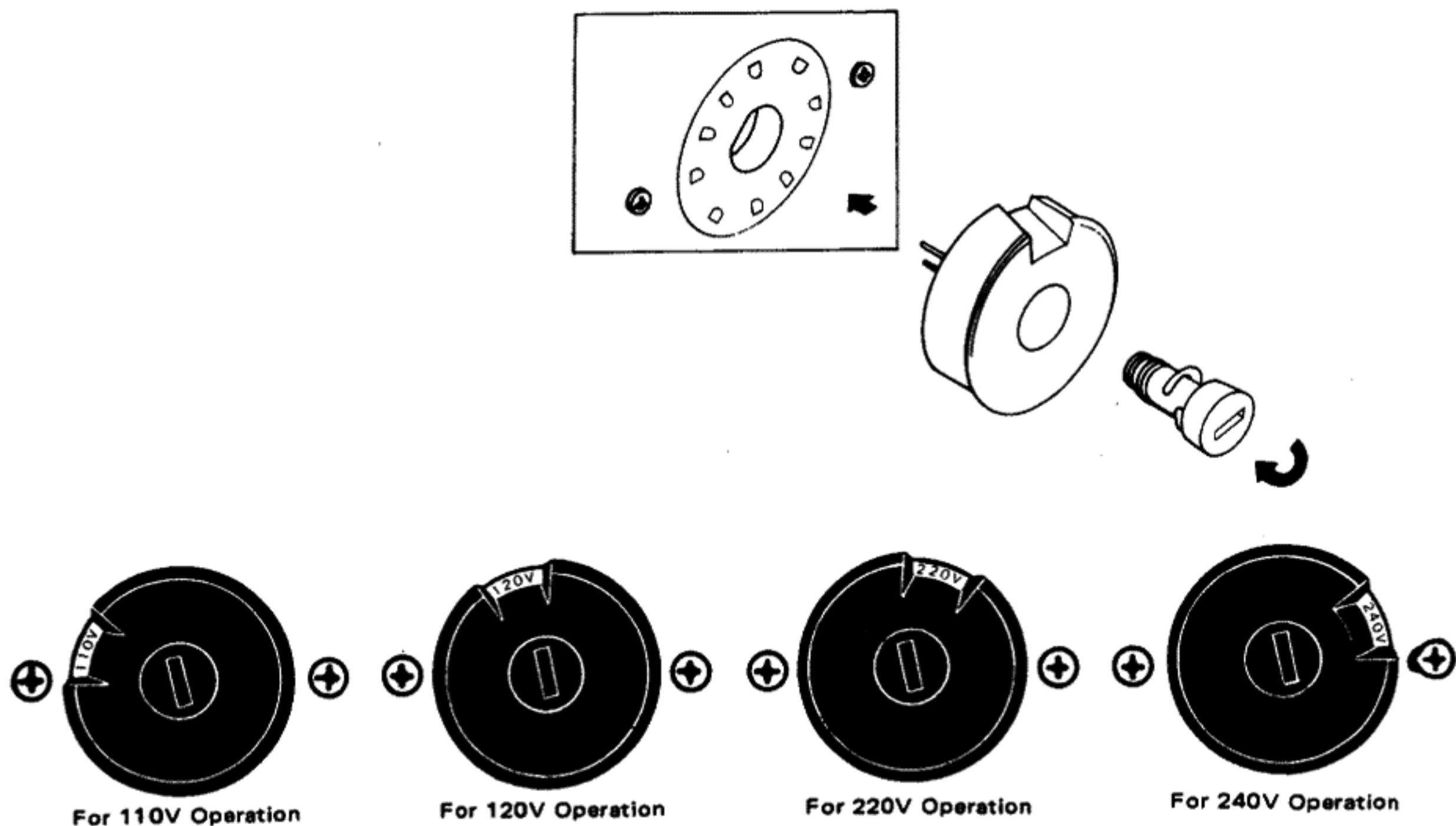

## 5. MAJOR COMPONENT LOCATIONS

### 5.1 FRONT PANEL ADJUSTMENT AND COMPONENT LOCATIONS

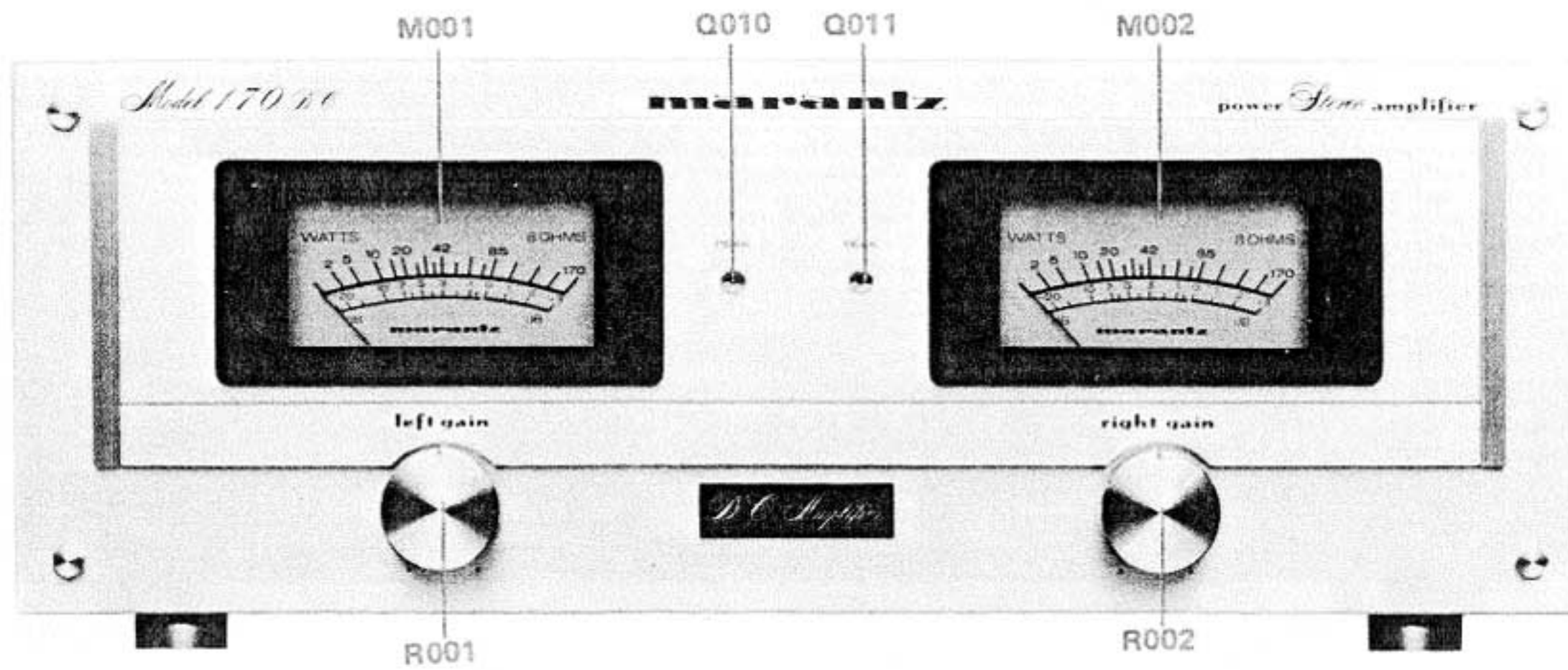

### 5.2 MAIN CHASSIS COMPONENT LOCATIONS (TOP VIEW)

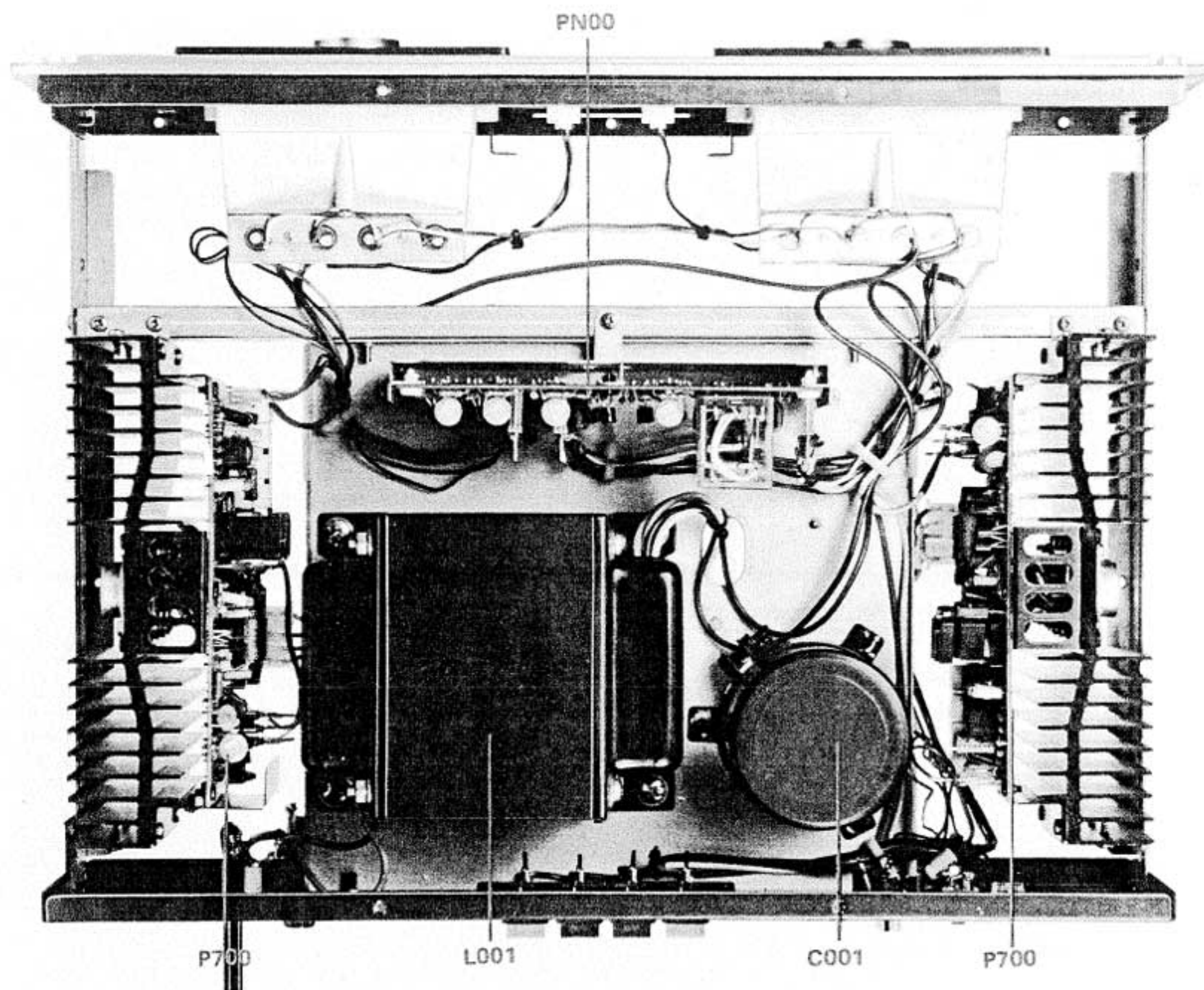

### 5.3 REAR PANEL ADJUSTMENT AND COMPONENT LOCATIONS

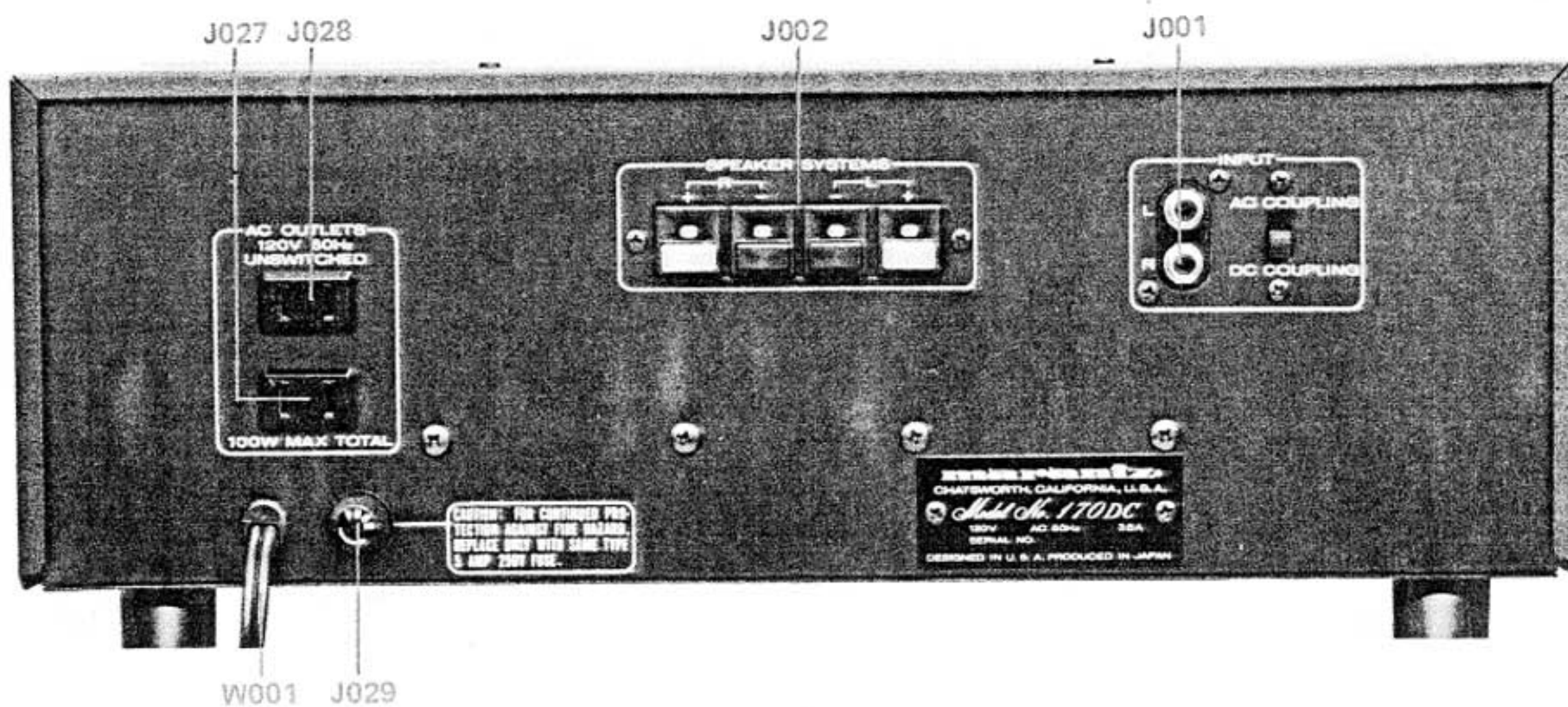

### 5.4 MAIN CHASSIS COMPONENT LOCATIONS (BOTTOM VIEW)

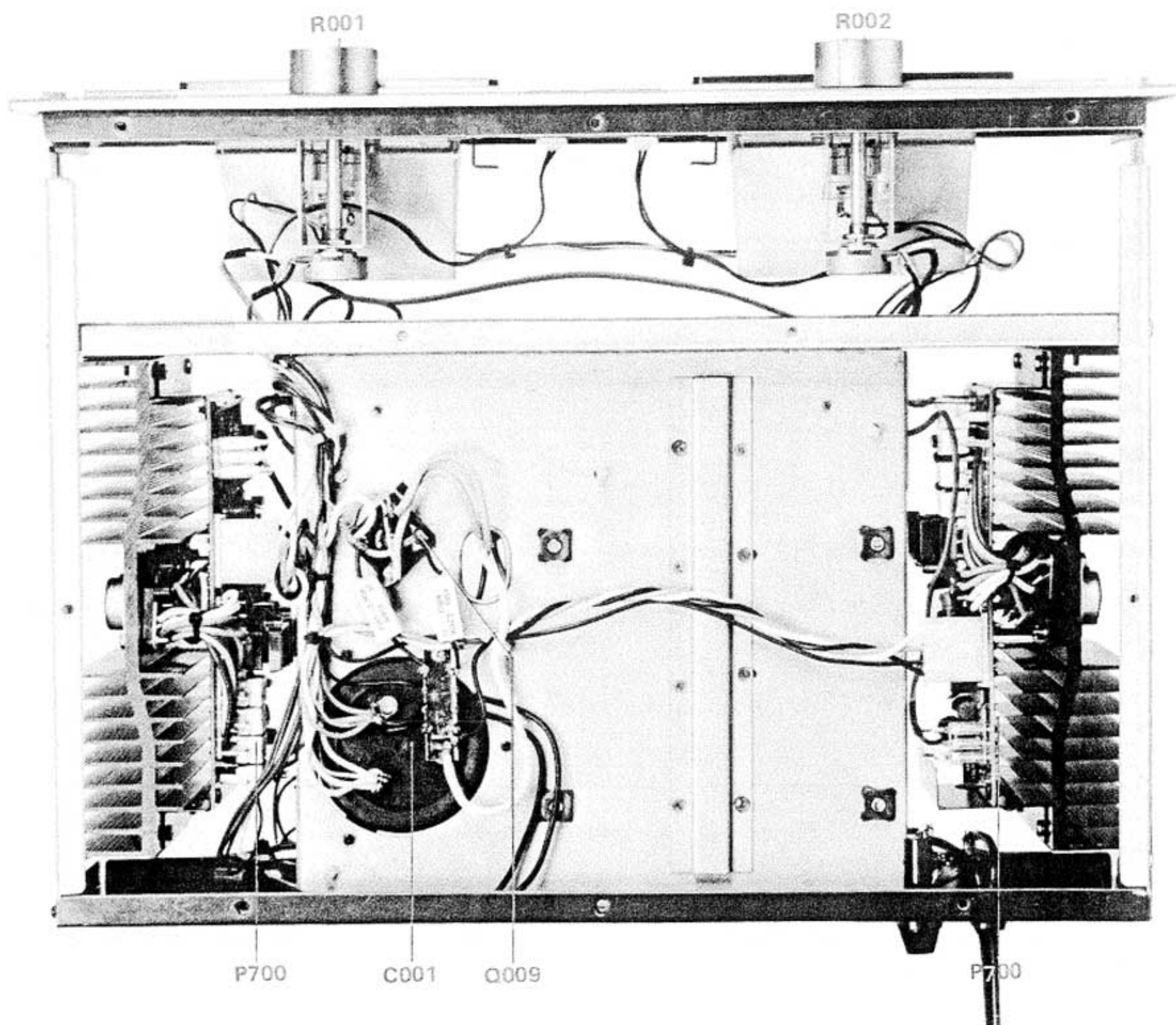

• EUROPEAN MODEL ONLY

5.5 FRONT PANEL ADJUSTMENT AND COMPONENT LOCATIONS

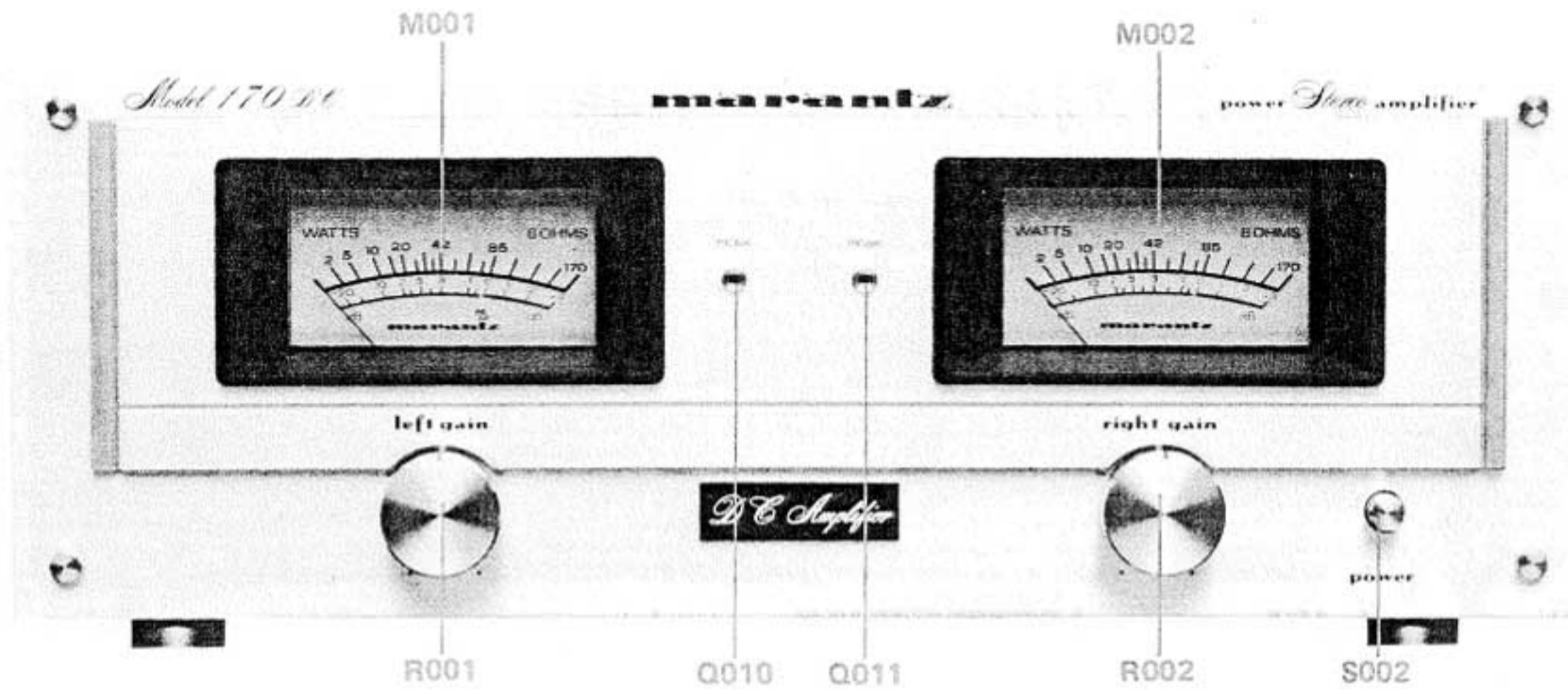

5.6 MAIN CHASSIS COMPONENT LOCATIONS (TOP VIEW)

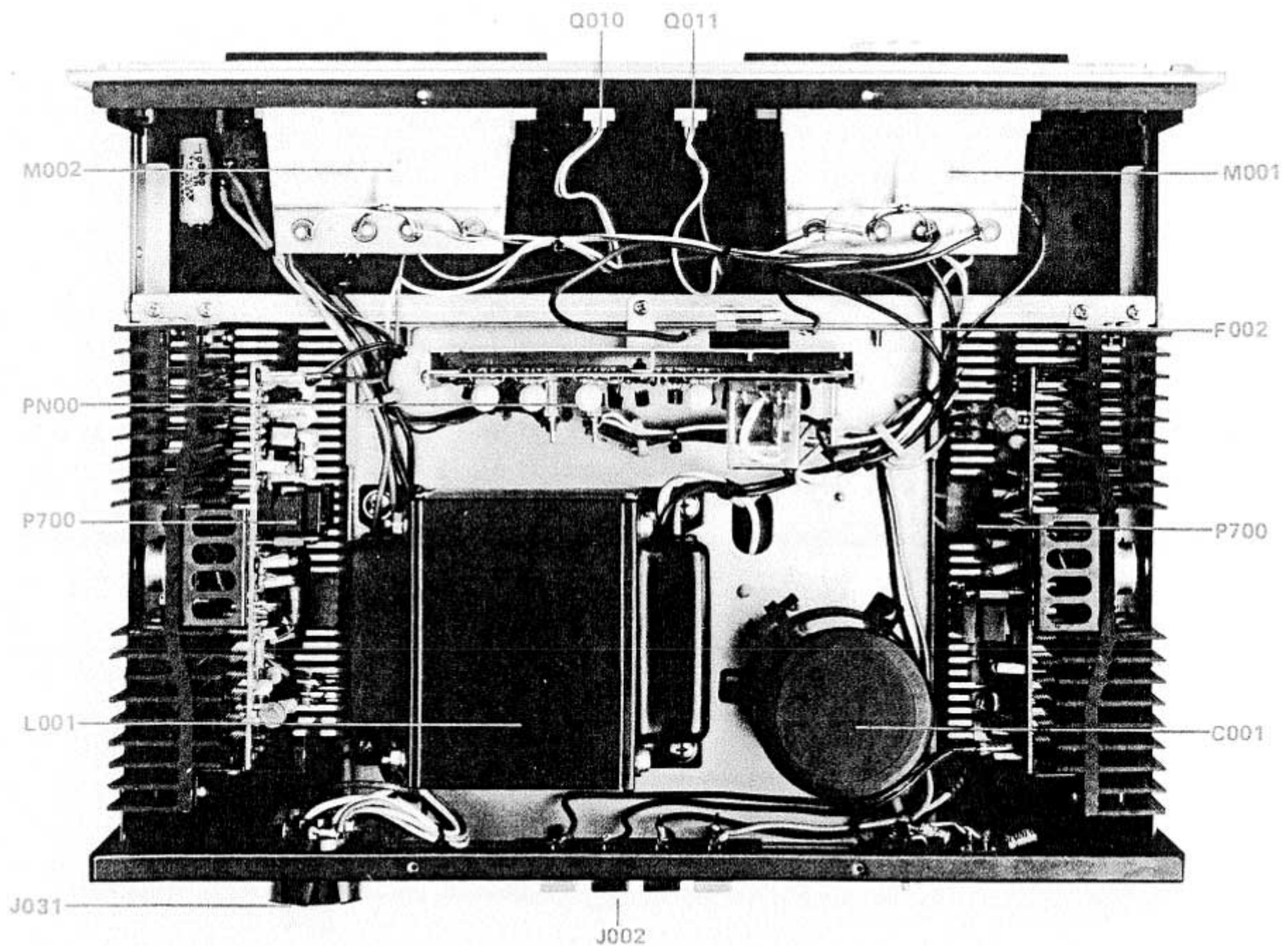



## 5.7 REAR PANEL ADJUSTMENT AND COMPONENT LOCATIONS

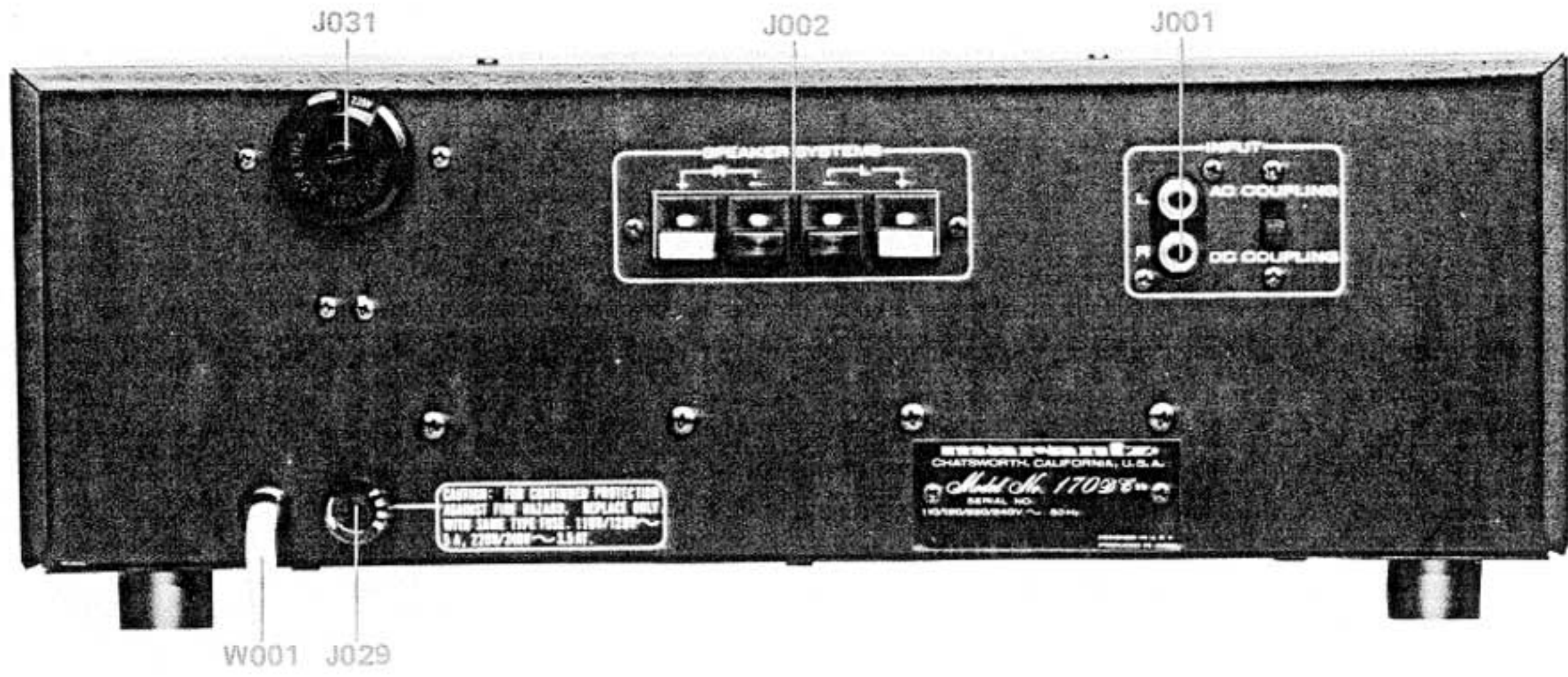

## 5.8 MAIN CHASSIS COMPONENT LOCATIONS (BOTTOM VIEW)

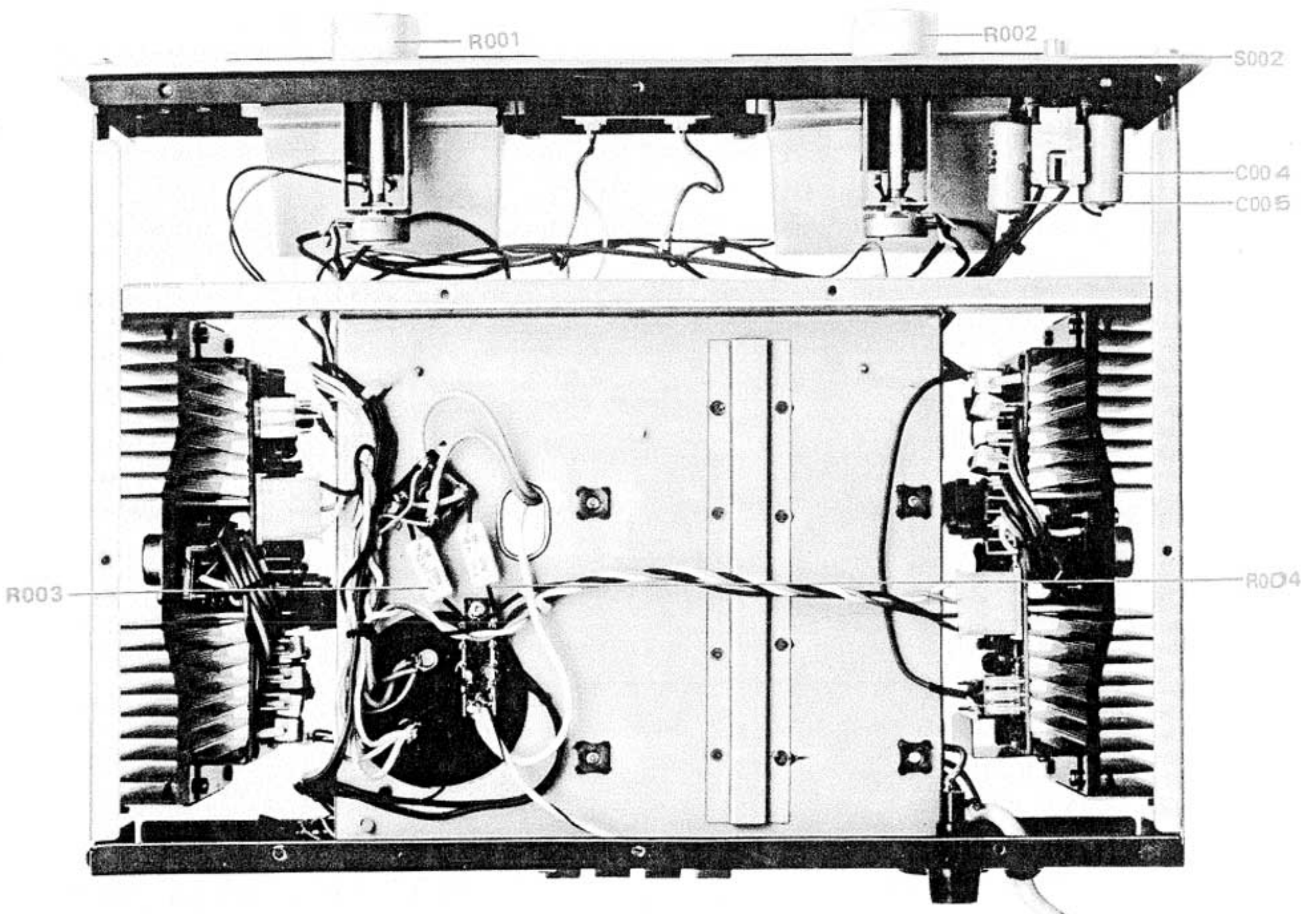

## 6. DIAGRAM AND COMPONENT LOCATIONS

### 6.1 MAIN AMP. ASSEMBLY (P700) SCHEMATIC DIAGRAM AND COMPONENT LOCATIONS

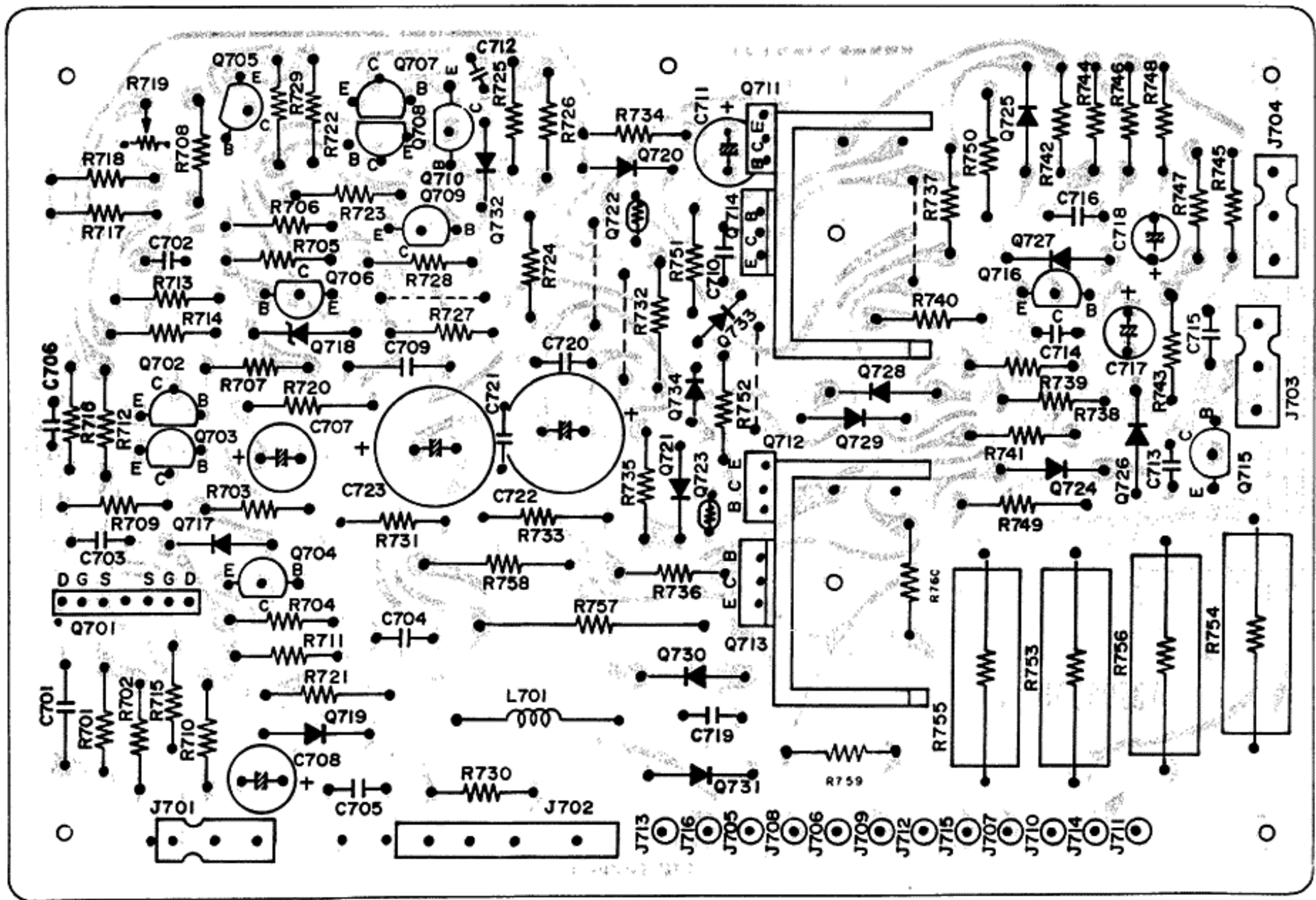
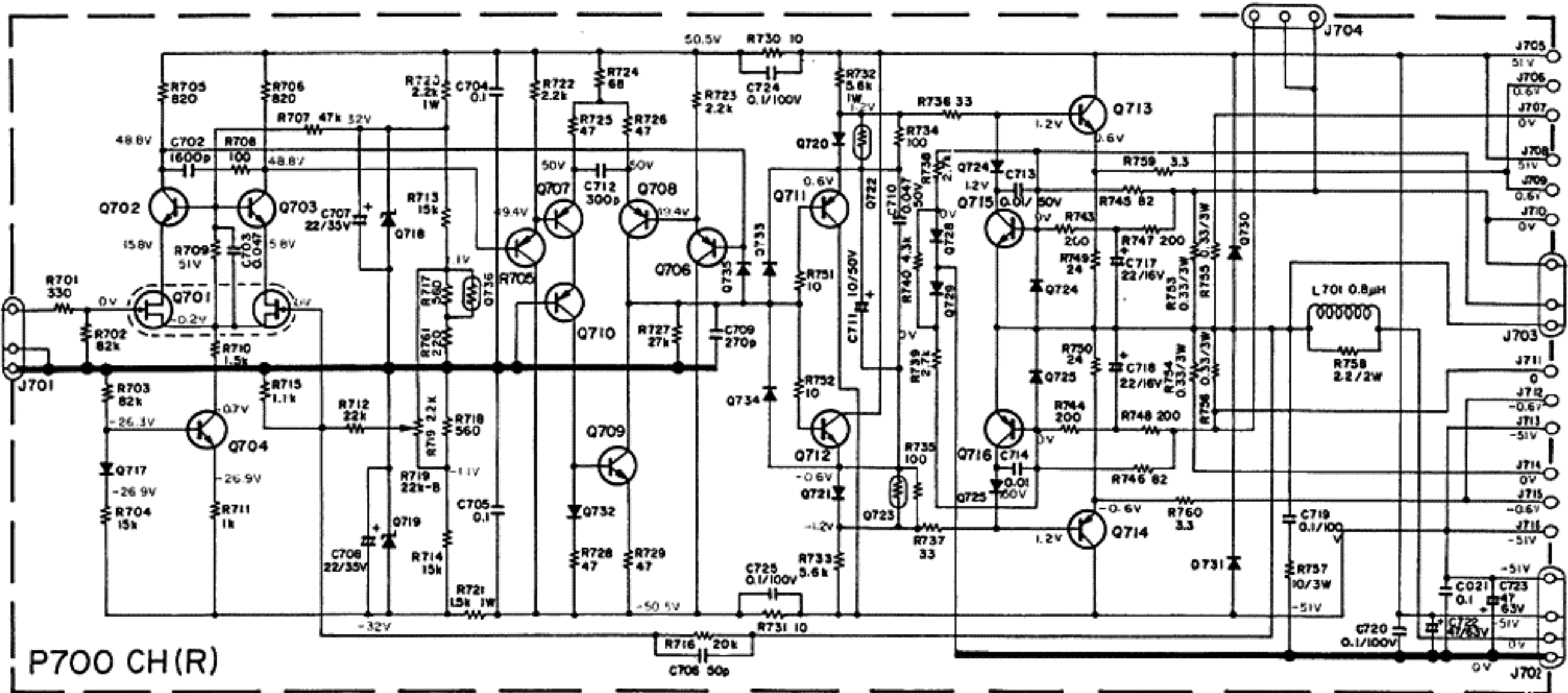



# 7. BLOCK DIAGRAM

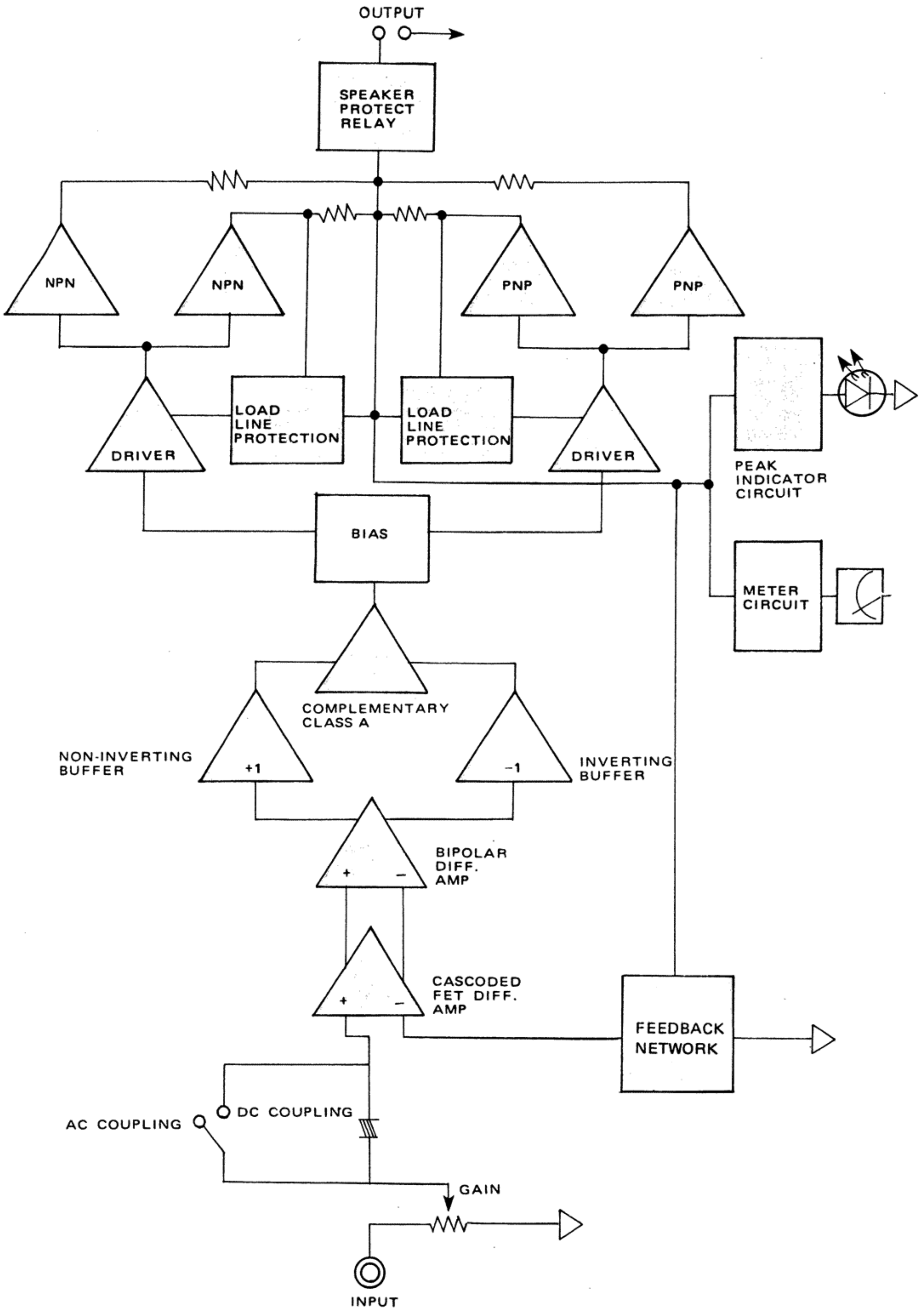

# 8. PACKING MATERIAL EXPLODED VIEW

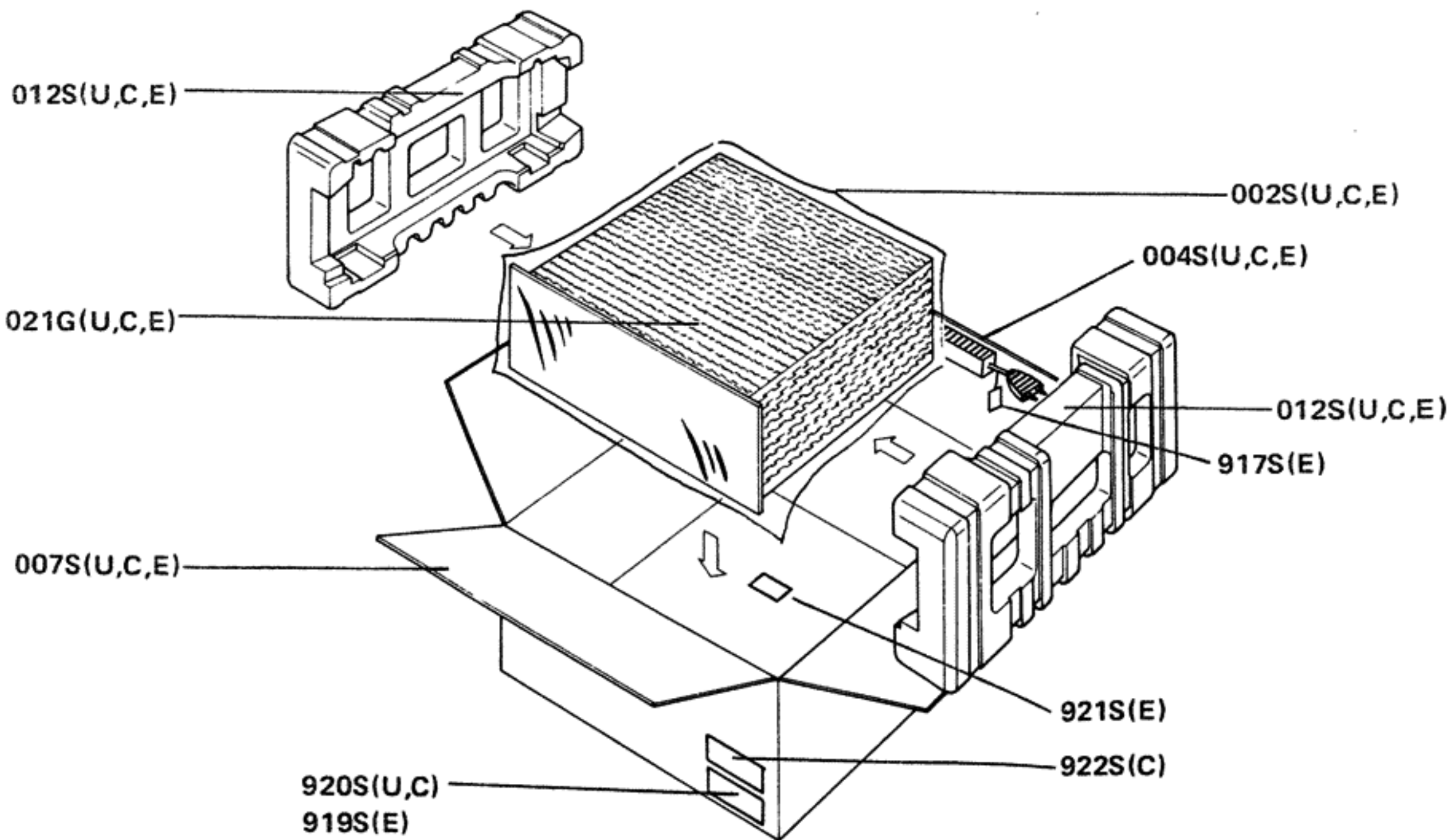
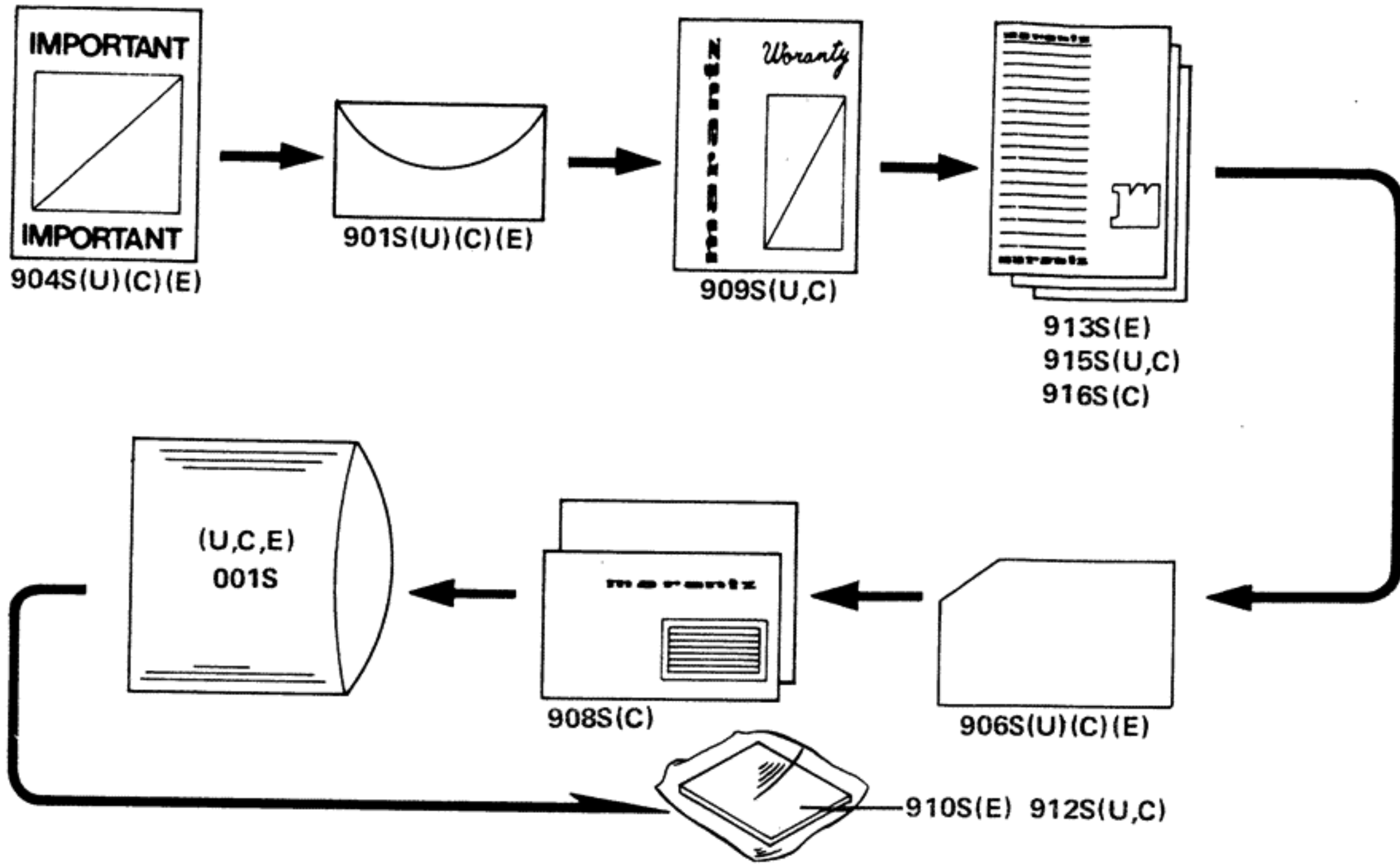

- (U) for U.S.A.
- (C) for Canada
- (E) for Europe

9. CONNECTION DIAGRAM

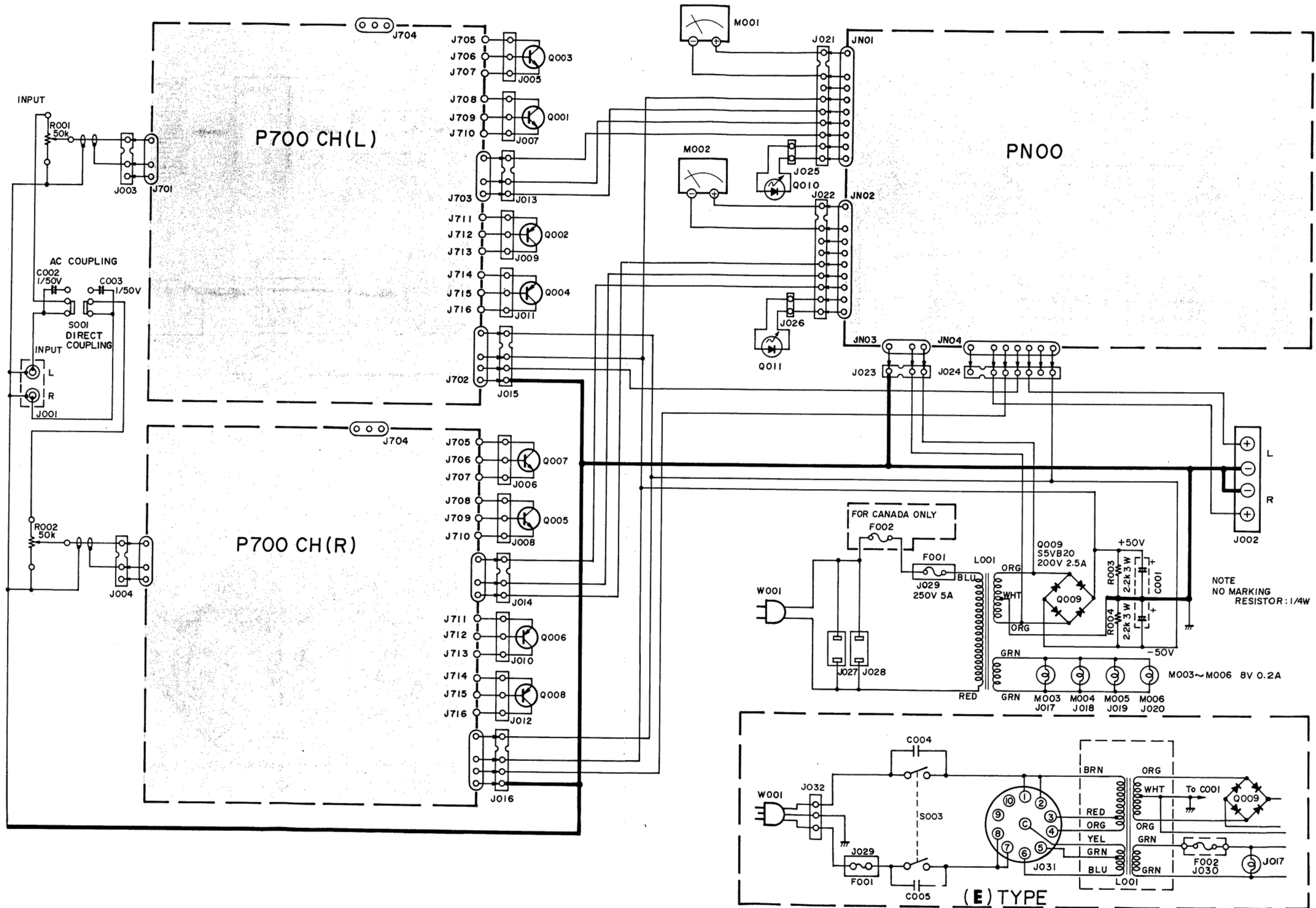







- (U) for U.S.A.
- (C) for Canada
- (E) for Europe

REF. DESIG.	Q'TY			PART NO.	DESCRIPTION	REF. DESIG.	Q'TY			PART NO.	DESCRIPTION
	U	C	E				U	C	E		
904S	1			2577851020	Instructions	JN01	1	1	1	YP06001070	Plug, 9P Connector
904S		1	1	2818851120	Instructions	JN02	1	1	1	YP06001070	Plug, 9P Connector
905B	2	2	2	2979154014	Knob	JN03	1	1	1	YP06001040	Plug, 3P Connector
905R			1	2882861020	Label	JN04	1	1	1	YP06001060	Plug, 7P Connector
905R	1			9510911010	Label	LN01	1	1	1	LY40240040	Relay, MS4U 24V
905R	1			9510911020	Label	QN01	1	1	1	HT309452A0	Transistor, 2SC945 (Q or R)
906B			1	2970154032	Knob	QN02	1	1	1	HT309452A0	Transistor, 2SC945 (Q or R)
906R			1	9512601060	Label	QN03	1	1	1	HT309452A0	Transistor, 2SC945 (Q or R)
906S	1			2577854012	Guarantee Card	QN04	1	1	1	HT309452A0	Transistor, 2SC945 (Q or R)
906S		1	1	9630000180	Guarantee Card	QN05	1	1	1	HT309452A0	Transistor, 2SC945 (Q or R)
907G			1	51102608A0	B.H.M. Screw, B2.6 x 8	QN06	1	1	1	HT309452A0	Transistor, 2SC945 (Q or R)
908G			1	53112603E0	Hexagon Nut	QN09	1	1	1	HT309452A0	Transistor, 2SC945 (Q or R)
908L	1			2991861010	Label	QN10	1	1	1	HT313182B0	Transistor, 2SC1318 (R or S)
908S		1		9650000050	S. Station Card	QN11	1	1	1	HT313182B0	Transistor, 2SC1318 (R or S)
909G			1	2965105012	Chassis	QN13	1	1	1	HD30023090	Zener, WZ-071 7V
909S	1			2818854023	Guarantee Card	QN14	1	1	1	HD20011030	Diode, DS131B 200V
909S		1		2818854042	Guarantee Card	QN15	1	1	1	HT108722D0	Transistor, 2SA872A (D or E)
910B	1	1		2965160215	Bracket	QN16	1	1	1	HT108722D0	Transistor, 2SA872A (D or E)
910B			1	2965160223	Bracket	QN17	1	1	1	HT108722D0	Transistor, 2SA872A (D or E)
910G			1	51280312B0	B.H. Tapped Screw, B3 x 12	QN18	1	1	1	HT108722D0	Transistor, 2SA872A (D or E)
910R		1		2911861162	Label	QN19	1	1	1	HT317752E0	Transistor, 2SC1775A (E or F)
910S			1	2818851140	Instructions	QN20	1	1	1	HT317752E0	Transistor, 2SC1775A (E or F)
912B			1	1455259040	Bushing	QN21	1	1	1	HD20003210	Diode, 1S2471
912B	1	1		1455259070	Bushing	QN22	1	1	1	HD20003210	Diode, 1S2471
912S	1			2818851040	Instructions	QN23	1	1	1	HD20001210	Diode, 1S2473
912S		1		2818851140	Instructions	QN24	1	1	1	HD20001210	Diode, 1S2473
913S			1	2965851310	Instructions	QN25	1	1	1	HD20001210	Diode, 1S2473
915R		1		2911861240	Label	QN26	1	1	1	HD20001210	Diode, 1S2473
915S	1			2965851012	Instructions	QN27	1	1	1	HD20018050	Diode, 1S2092
915S			1	2965851030	Instructions	QN28	1	1	1	HD20018050	Diode, 1S2092
915S		1		2965851310	Instructions	QN29	1	1	1	HD20005010	Diode, W06B
916B	1			2965265010	Indicator	QN30	1	1	1	HD20005010	Diode, W06B
916B		1		2965265020	Indicator	RN01	1	1	1	RA02230020	Trimming Resistor, 22kΩ (B)
916B			1	2965265032	Indicator	RN02	1	1	1	RA02230020	Trimming Resistor, 22kΩ (B)
916R		1		2911861192	Label	RN03	1	1	1	RA02220080	Trimming Resistor, 2.2kΩ (B)
916S		1		2886851100	Instructions	RN04	1	1	1	RA02220080	Trimming Resistor, 2.2kΩ (B)
917R		1		9510601050	Label	RN05	1	1	1	RT05153140	Resistor, 15kΩ ±5% ¼W
917S			1	9560000042	Hang Tag	RN06	1	1	1	RT05153140	Resistor, 15kΩ ±5% ¼W
918B			2	51100308S9	B.H.M. Screw, B3 x 8	RN07	1	1	1	RT05223140	Resistor, 22kΩ ±5% ¼W
918S	1			2965851020	Instructions	RN08	1	1	1	RT05223140	Resistor, 22kΩ ±5% ¼W
918S		1		2965851050	Instructions	RN09	1	1	1	RT05221140	Resistor, 220Ω ±5% ¼W
919S			4	9523015110	Serial No. Card	RN10	1	1	1	RT05221140	Resistor, 220Ω ±5% ¼W
920B			2	51100314S9	B.H.M. Screw, B3 x 14	RN11	1	1	1	RT05272140	Resistor, 27kΩ ±5% ¼W
920G			4	2970120030	Insulator	RN12	1	1	1	RT05272140	Resistor, 27kΩ ±5% ¼W
920S	4			9522815010	Serial No. Card	RN13	1	1	1	RT05681140	Resistor, 680Ω ±5% ¼W
920S		4		9523015120	Serial No. Card	RN14	1	1	1	RT05681140	Resistor, 680Ω ±5% ¼W
921B			1	2970005010	Clamper	RN15	1	1	1	RT05103140	Resistor, 10kΩ ±5% ¼W
921S			1	2731821010	Silicagel	RN16	1	1	1	RT05103140	Resistor, 10kΩ ±5% ¼W
922B			1	4113120010	Insulator	RN17	1	1	1	RT05393140	Resistor, 39kΩ ±5% ¼W
922S		2		9510901020	Label	RN18	1	1	1	RT05393140	Resistor, 39kΩ ±5% ¼W
<b>PN00 PEAK IND. RELAY &amp; METER BOARD</b>						RN19	1	1	1	RT05183140	Resistor, 18kΩ ±5% ¼W
PN00	1	1	1	YG29650022	P.W. Board	RN20	1	1	1	RT05183140	Resistor, 18kΩ ±5% ¼W
PN00		1	1	ZZ29650020	P.W. Board Assembly	RN21	1	1	1	RT05302140	Resistor, 3kΩ ±5% ¼W
CN01	1	1	1	EA33505090	Electrolytic Cap., 3.3μF 50V	RN22	1	1	1	RT05302140	Resistor, 3kΩ ±5% ¼W
CN02	1	1	1	EA33505090	Electrolytic Cap., 3.3μF 50V						
CN03	1	1	1	DF17104520	Film Cap., 0.1μF 200V						
CN04	1	1	1	EA10606390	Electrolytic Cap., 10μF 63V						
CN05	1	1	1	EA22701690	Electrolytic Cap., 220μF 16V						
CN06	1	1	1	EA47601690	Electrolytic Cap., 47μF 16V						
CN07	1	1	1	EA47601690	Electrolytic Cap., 47μF 16V						

- (U) for U.S.A.
- (C) for Canada
- (E) for Europe

REF. DESIG.	Q'TY			PART NO.	DESCRIPTION	REF. DESIG.	Q'TY			PART NO.	DESCRIPTION
	U	C	E				U	C	E		
RN23	1	1	1	RT05753140	Resistor, 75kΩ ±5% ¼W	J020	1	1	1	YJ08000190	Jack, Lamp Socket
RN24	1	1	1	RT05753140	Resistor, 75kΩ ±5% ¼W	J021	1	1	1	YJ06001070	Jack, 9P Connector
RN25	1	1	1	RT05753140	Resistor, 75kΩ ±5% ¼W	J022	1	1	1	YJ06001070	Jack, 9P Connector
RN26	1	1	1	RT05753140	Resistor, 75kΩ ±5% ¼W	J023	1	1	1	YJ06001040	Jack, 3P Connector
RN27	1	1	1	RT05473140	Resistor, 47kΩ ±5% ¼W	J024	1	1	1	YJ06001060	Jack, 7P Connector
RN28	1	1	1	RT05473140	Resistor, 47kΩ ±5% ¼W	J025	1	1	1	YJ05000250	Jack, LED Socket
RN29	1	1	1	RT05473140	Resistor, 47kΩ ±5% ¼W	J026	1	1	1	YJ05000250	Jack, LED Socket
RN30	1	1	1	RT05473140	Resistor, 47kΩ ±5% ¼W	J027	1	1		YJ04000560	Jack, AC Outlet
RN31	1	1	1	RT05183140	Resistor, 18kΩ ±5% ¼W	J028	1	1		YJ04000560	Jack, AC Outlet
RN32	1	1	1	RT05183140	Resistor, 18kΩ ±5% ¼W	J029	1	1		YJ08000120	Jack, Fuse Holder
RN33	1	1	1	RT05333140	Resistor, 33kΩ ±5% ¼W	J029		1		YJ08000220	Jack, Fuse Holder
RN34	1	1	1	RT05333140	Resistor, 33kΩ ±5% ¼W	J030		1		YJ08000090	Jack, Fuse Holder
RN35	1	1	1	RT05223140	Resistor, 22kΩ ±5% ¼W	J031		1		BY03110010	Plug, Line Selector
RN36	1	1	1	RT05223140	Resistor, 22kΩ ±5% ¼W	J032		1		YL09030010	Terminal, 3P
RN37	1	1	1	RT05104140	Resistor, 100kΩ ±5% ¼W	L001	1	1		TS60504050	Power Transformer
RN38	1	1	1	RT05104140	Resistor, 100kΩ ±5% ¼W	L001		1		TS60504060	Power Transformer
RN39	1	1	1	RT05822140	Resistor, 82kΩ ±5% ¼W	M001		1		IM11082050	D.C. Meter, Level
RN40	1	1	1	RT05822140	Resistor, 82kΩ ±5% ¼W	M001	1			IM11082052	D.C. Meter, Level
RN41	1	1	1	RT05512140	Resistor, 5.1kΩ ±5% ¼W	M001		1		IM11082050	D.C. Meter, Level
RN42	1	1	1	RT05512140	Resistor, 5.1kΩ ±5% ¼W	M002	1			IM11082052	D.C. Meter, Level
RN43	1	1	1	RT05273140	Resistor, 27kΩ ±5% ¼W	M002		1	1	IM11082050	D.C. Meter, Level
RN44	1	1	1	RT05273140	Resistor, 27kΩ ±5% ¼W	M003	1	1	1	IN10080430	Lamp, Meter
RN45	1	1	1	RT05123140	Resistor, 12kΩ ±5% ¼W	M004	1	1	1	IN10080430	Lamp, Meter
RN46	1	1	1	GJ05471010	Resistor, 470Ω ±5% 1W	M005	1	1	1	IN10080430	Lamp, Meter
RN47	1	1	1	RT05224140	Resistor, 220kΩ ±5% ¼W	M006	1	1	1	IN10080430	Lamp, Meter
RN48	1	1	1	RT05243140	Resistor, 24kΩ ±5% ¼W	Q001	1	1	1	HT404272A0	Transistor, 2SD427 (R or O)
RN49	1	1	1	RT05273140	Resistor, 27kΩ ±5% ¼W	Q002	1	1	1	HT205572A0	Transistor, 2SB557 (R or O)
RN50	1	1	1	RT05682140	Resistor, 6.8kΩ ±5% ¼W	Q003	1	1	1	HT404272A0	Transistor, 2SD427 (R or O)
RN51	1	1	1	RT05243140	Resistor, 24kΩ ±5% ¼W	Q004	1	1	1	HT205572A0	Transistor, 2SB557 (R or O)
RN52	1	1	1	RT05562140	Resistor, 5.6kΩ ±5% ¼W	Q005	1	1	1	HT404272A0	Transistor, 2SD427 (R or O)
RN53	1	1	1	RT05562140	Resistor, 5.6kΩ ±5% ¼W	Q006	1	1	1	HT205572A0	Transistor, 2SB557 (R or O)
RN54	1	1	1	GJ05332010	Resistor, 3.3kΩ ±5% 1W	Q007	1	1	1	HT404272A0	Transistor, 2SD427 (R or O)
RN55	1	1	1	RT05511140	Resistor, 510Ω ±5% ¼W	Q008	1	1	1	HT205572A0	Transistor, 2SB557 (R or O)
RN56	1	1	1	RT05511140	Resistor, 510Ω ±5% ¼W	Q009	1	1	1	HD20004290	Diode, S5VB-20
C001	1	1	1	ES12906310	Electrolytic Cap., 12000μF x 2 63V	Q010	1	1	1	H110004030	L.E.D., 132B
C002	1	1	1	EQ10505010	Electrolytic Cap., 1μF 50V	Q011	1	1	1	H110004030	L.E.D., 132B
C003	1	1	1	EQ10505010	Electrolytic Cap., 1μF 50V	R001	1	1	1	RK05030200	Variable Resistor, 50kΩ (B)
C004			1	DD07473540	Oil-Paper Cap., 0.047μF ±20% 450V	R002	1	1	1	RK05030200	Variable Resistor, 50kΩ (B)
C005			1	DD07473540	Oil-Paper Cap., 0.047μF ±20% 450V	R003	1	1	1	GS10222030	Resistor, 2.2kΩ ±10% 3W
F001			1	FS10350800	Fuse, 3.5AT SEMKO Type	R004	1	1	1	GS10222030	Resistor, 2.2kΩ ±10% 3W
F001	1	1		FS10500040	Fuse, 5A MGC UL	S001	1	1	1	SS02020380	Slide Switch, DC/AC Coupling
F002			1	FS10200800	Fuse, 2AT SEMKO Type	S002		1		SP02010250	Pushswitch, Power SDG-5P SEMKO
F002			1	FS20500010	Fuse, 5A	W001		1		YC01900030	A.C. Power Cord
J001	1	1	1	YT02020140	Terminal, 2P Input Pin Jack	W001	1	1		YC02400170	A.C. Power Cord
J002	1	1	1	YT03040160	Terminal, Speaker						
J003	1	1	1	YJ06001040	Jack, 3P Connector						
J004	1	1	1	YJ06001040	Jack, 3P Connector						
J005											
J012	8	8	8	YJ05000220	Jack, Transistor Socket	P700	2	2	2	YG29650040	P700 MAIN AMP. BOARD
J013	1	1	1	YJ06001040	Jack, 3P Connector						
J014	1	1	1	YJ06001040	Jack, 3P Connector						
J015	1	1	1	YJ06001080	Jack, 4P Mini Connector						
J016	1	1	1	YJ06001090	Jack, 4P Mini Connector						
J017	1	1	1	YJ08000190	Jack, Lamp Socket						
J018	1	1	1	YJ08000190	Jack, Lamp Socket						
J019	1	1	1	YJ08000190	Jack, Lamp Socket						
						C701	2	2	2	DF65251010	Film Cap., 250pF ±5% 50V
						C702	2	2	2	DF65162010	Film Cap., 1600pF ±5% 50V
						C703	2	2	2	DF16473010	Film Cap., 0.047μF ±10% 50V
						C704	2	2	2	DF17104540	Film Cap., 0.1μF ±20% 100V
						C705	2	2	2	DF17104540	Film Cap., 0.1μF ±20% 100V
						C706	2	2	2	DD15500500	Ceramic Cap., 50pF ±5% 500V
						C707	2	2	2	EA22603590	Electrolytic Cap., 22μF 35V
						C708	2	2	2	EA22603590	Electrolytic Cap., 22μF 35V
						C709	2	2	2	DF65271510	Film Cap., 270pF ±5%
						C710	2	2	2	DF16473010	Film Cap., 0.047μF ±10% 50V
						C711	2	2	2	EA10605090	Electrolytic Cap., 10μF 50V
						C712	2	2	2	DF65301510	Film Cap., 300pF ±5%
						C713	2	2	2	DF16103010	Film Cap., 0.01μF ±10% 50V

- (U) for U.S.A.
- (C) for Canada
- (E) for Europe

REF. DESIG.	Q'TY			PART NO.	DESCRIPTION
	U	C	E		
C714	2	2	2	DF16103010	Film Cap., 0.01 $\mu$ F $\pm$ 10% 50V
C715	2	2	2	DF16104010	Film Cap., 0.1 $\mu$ F $\pm$ 10% 50V
C716	2	2	2	DF16104010	Film Cap., 0.1 $\mu$ F $\pm$ 10% 50V
C717	2	2	2	EE10601640	Electrolytic Cap., 10 $\mu$ F $\pm$ 20% 16V
C718	2	2	2	EE10601640	Electrolytic Cap., 10 $\mu$ F $\pm$ 20% 16V
C719	2	2	2	DF17104540	Film Cap., 0.1 $\mu$ F $\pm$ 20% 100V
C720	2	2	2	DF17104540	Film Cap., 0.1 $\mu$ F $\pm$ 20% 100V
C721	2	2	2	DF17104540	Film Cap., 0.1 $\mu$ F $\pm$ 20% 100V
C722	2	2	2	EA47606390	Electrolytic Cap., 47 $\mu$ F 63V
C723	2	2	2	EA47606390	Electrolytic Cap., 47 $\mu$ F 63V
J701	2	2	2	YP06001040	Plug, 3P Connector
J702	2	2	2	YP06000520	Plug, 4P Connector
J703	2	2	2	YP06001040	Plug, 3P Connector
J704	2	2	2	YP06001040	Plug, 3P Connector
J705					
J716	12	12	12	YP10001130	Plug, Wrapping Pin
L701	2	2	2	LC22620010	Choke Coil, 2.6 $\mu$ H
Q701	2	2	2	HC10003200	IC, 2SK109 Dual FET IDSS (C or D)
Q702	2	2	2	HT317752E0	Transistor, 2SC1775A (E or F)
Q703	2	2	2	HT317752E0	Transistor, 2SC1775A (E or F)
Q704	2	2	2	HT317752E0	Transistor, 2SC1775A (E or F)
Q705	2	2	2	HT108722D0	Transistor, 2SA872A (D or E)
Q706	2	2	2	HT108722D0	Transistor, 2SA872A (D or E)
Q707	2	2	2	HT108721E0	Transistor, 2SA872A (E)
Q708	2	2	2	HT108721E0	Transistor, 2SA872A (E)
Q709	2	2	2	HT317751E0	Transistor, 2SC1775A (E)
Q710	2	2	2	HT108721E0	Transistor, 2SA872A (E)
Q711	2	2	2	HT109142B0	Transistor, 2SA914 (R or S)
Q712	2	2	2	HT319532B0	Transistor, 2SC1953 (R or S)
Q713	2	2	2	HT319132B0	Transistor, 2SC1913 (Q or R)
Q714	2	2	2	HT109132B0	Transistor, 2SA913 (Q or R)
Q715	2	2	2	HT309452A0	Transistor, 2SC945 (Q or R)
Q716	2	2	2	HT107332A0	Transistor, 2SA733 (Q or R)
Q717	2	2	2	HD20011050	Diode, 1S1555
Q718	2	2	2	HD30046090	Zener, BZ-310
Q719	2	2	2	HD30046090	Zener, BZ-310
Q720	2	2	2	HV00004120	Varistor, MV-1
Q721	2	2	2	HV00004120	Varistor, MV-1
Q722	2	2	2	HH00007030	Thermistor, SDT-100 (1k $\Omega$ )
Q723	2	2	2	HH00007030	Thermistor, SDT-100 (1k $\Omega$ )
Q724	2	2	2	HD20011050	Diode, 1S1555
Q725	2	2	2	HD20011050	Diode, 1S1555
Q726	2	2	2	HD20011050	Diode, 1S1555
Q727	2	2	2	HD20011050	Diode, 1S1555
Q728	2	2	2	HD20011050	Diode, 1S1555
Q729	2	2	2	HD20011050	Diode, 1S1555
Q730	2	2	2	HD20011010	Diode, W06C
Q731	2	2	2	HD20011010	Diode, W06C
Q732	2	2	2	HD20011050	Diode, 1S1555
Q733	2	2	2	HD20011050	Diode, 1S1555
Q734	2	2	2	HD20011050	Diode, 1S1555
R701	2	2	2	RT05472140	Resistor, 4.7k $\Omega$ $\pm$ 5% $\frac{1}{4}$ W

REF. DESIG.	Q'TY			PART NO.	DESCRIPTION
	U	C	E		
R702	2	2	2	RT05104140	Resistor, 100k $\Omega$ $\pm$ 5% $\frac{1}{4}$ W
R703	2	2	2	RT05124140	Resistor, 120k $\Omega$ $\pm$ 5% $\frac{1}{4}$ W
R704	2	2	2	RT05183140	Resistor, 18k $\Omega$ $\pm$ 5% $\frac{1}{4}$ W
R705	2	2	2	RT05821140	Resistor, 820 $\Omega$ $\pm$ 5% $\frac{1}{4}$ W
R706	2	2	2	RT05821140	Resistor, 820 $\Omega$ $\pm$ 5% $\frac{1}{4}$ W
R707	2	2	2	RT05473140	Resistor, 47k $\Omega$ $\pm$ 5% $\frac{1}{4}$ W
R708	2	2	2	RT05101140	Resistor, 100 $\Omega$ $\pm$ 5% $\frac{1}{4}$ W
R709	2	2	2	RT05513140	Resistor, 51k $\Omega$ $\pm$ 5% $\frac{1}{4}$ W
R710	2	2	2	RT05152140	Resistor, 1.5k $\Omega$ $\pm$ 5% $\frac{1}{4}$ W
R711	2	2	2	RT05102140	Resistor, 1k $\Omega$ $\pm$ 5% $\frac{1}{4}$ W
R712	2	2	2	RT05223140	Resistor, 22k $\Omega$ $\pm$ 5% $\frac{1}{4}$ W
R713	2	2	2	RT05153140	Resistor, 15k $\Omega$ $\pm$ 5% $\frac{1}{4}$ W
R714	2	2	2	RT05153140	Resistor, 15k $\Omega$ $\pm$ 5% $\frac{1}{4}$ W
R715	2	2	2	RT02112140	Resistor, 1.1k $\Omega$ $\pm$ 5% $\frac{1}{4}$ W
R716	2	2	2	RT02203140	Resistor, 20k $\Omega$ $\pm$ 5% $\frac{1}{4}$ W
R717	2	2	2	RT05561140	Resistor, 560 $\Omega$ $\pm$ 5% $\frac{1}{4}$ W
R718	2	2	2	RT05561140	Resistor, 560 $\Omega$ $\pm$ 5% $\frac{1}{4}$ W
R719	2	2	2	RA02230050	Trimming Resistor, 22k $\Omega$
R720	2	2	2	GJ05222010	Resistor, 2.2k $\Omega$ $\pm$ 5% 1W
R721	2	2	2	GJ05152010	Resistor, 1.5k $\Omega$ $\pm$ 5% 1W
R722	2	2	2	RT05222140	Resistor, 2.2k $\Omega$ $\pm$ 5% $\frac{1}{4}$ W
R723	2	2	2	RT05222140	Resistor, 2.2k $\Omega$ $\pm$ 5% $\frac{1}{4}$ W
R724	2	2	2	RT05680140	Resistor, 68 $\Omega$ $\pm$ 5% $\frac{1}{4}$ W
R725	2	2	2	RT05470140	Resistor, 47 $\Omega$ $\pm$ 5% $\frac{1}{4}$ W
R726	2	2	2	RT05470140	Resistor, 47 $\Omega$ $\pm$ 5% $\frac{1}{4}$ W
R727	2	2	2	RT05273140	Resistor, 27k $\Omega$ $\pm$ 5% $\frac{1}{4}$ W
R728	2	2	2	RT05151140	Resistor, 150 $\Omega$ $\pm$ 5% $\frac{1}{4}$ W
R729	2	2	2	RT05151140	Resistor, 150 $\Omega$ $\pm$ 5% $\frac{1}{4}$ W
R730	2	2	2	GF05100140	Resistor, 10 $\Omega$ $\pm$ 5% $\frac{1}{4}$ W
R731	2	2	2	GF05100140	Resistor, 10 $\Omega$ $\pm$ 5% $\frac{1}{4}$ W
R732	2	2	2	GJ05562010	Resistor, 5.6k $\Omega$ $\pm$ 5% 1W
R733	2	2	2	GJ05562010	Resistor, 5.6k $\Omega$ $\pm$ 5% 1W
R734	2	2	2	RT05750140	Resistor, 75 $\Omega$ $\pm$ 5% $\frac{1}{4}$ W
R735	2	2	2	RT05750140	Resistor, 75 $\Omega$ $\pm$ 5% $\frac{1}{4}$ W
R736	2	2	2	RT05330140	Resistor, 33 $\Omega$ $\pm$ 5% $\frac{1}{4}$ W
R737	2	2	2	RT05330140	Resistor, 33 $\Omega$ $\pm$ 5% $\frac{1}{4}$ W
R738	2	2	2	RT05822140	Resistor, 8.2k $\Omega$ $\pm$ 5% $\frac{1}{4}$ W
R739	2	2	2	RT05822140	Resistor, 8.2k $\Omega$ $\pm$ 5% $\frac{1}{4}$ W
R740	2	2	2	RT05243140	Resistor, 24k $\Omega$ $\pm$ 5% $\frac{1}{4}$ W
R741	2	2	2	RT05124140	Resistor, 120k $\Omega$ $\pm$ 5% $\frac{1}{4}$ W
R742	2	2	2	RT05124140	Resistor, 120k $\Omega$ $\pm$ 5% $\frac{1}{4}$ W
R743	2	2	2	RT05181140	Resistor, 180 $\Omega$ $\pm$ 5% $\frac{1}{4}$ W
R744	2	2	2	RT05181140	Resistor, 180 $\Omega$ $\pm$ 5% $\frac{1}{4}$ W
R745	2	2	2	RT05301140	Resistor, 300 $\Omega$ $\pm$ 5% $\frac{1}{4}$ W
R746	2	2	2	RT05301140	Resistor, 300 $\Omega$ $\pm$ 5% $\frac{1}{4}$ W
R747	2	2	2	RT05201140	Resistor, 200 $\Omega$ $\pm$ 5% $\frac{1}{4}$ W
R748	2	2	2	RT05201140	Resistor, 200 $\Omega$ $\pm$ 5% $\frac{1}{4}$ W
R749	2	2	2	GF05151120	Resistor, 150 $\Omega$ $\pm$ 5% $\frac{1}{2}$ W
R750	2	2	2	GF05151120	Resistor, 150 $\Omega$ $\pm$ 5% $\frac{1}{2}$ W
R751	2	2	2	RT05100140	Resistor, 10 $\Omega$ $\pm$ 5% $\frac{1}{4}$ W
R752	2	2	2	RT05100140	Resistor, 10 $\Omega$ $\pm$ 5% $\frac{1}{4}$ W
R753	2	2	2	GW10272030	Resistor, 0.27 $\Omega$ $\pm$ 10% 3W
R754	2	2	2	GW10272030	Resistor, 0.27 $\Omega$ $\pm$ 10% 3W
R755	2	2	2	GW10272030	Resistor, 0.27 $\Omega$ $\pm$ 10% 3W
R756	2	2	2	GW10272030	Resistor, 0.27 $\Omega$ $\pm$ 10% 3W
R757	2	2	2	GJ05100030	Resistor, 10 $\Omega$ $\pm$ 5% 3W
R758	2	2	2	GJ05022020	Resistor, 2.2 $\Omega$ $\pm$ 5% 2W
R759	2	2	2	RT05033140	Resistor, 3.3 $\Omega$ $\pm$ 5% $\frac{1}{4}$ W
R760	2	2	2	RT05033140	Resistor, 3.3 $\Omega$ $\pm$ 5% $\frac{1}{4}$ W

### 13. TECHNICAL SPECIFICATIONS

#### FOR U.S.A. MODEL ONLY

RATED POWER OUTPUT, MINIMUM CONTINUOUS AVERAGE POWER PER CHANNEL, BOTH CHANNELS DRIVEN	86 W
POWER BAND	20 Hz ~ 20 kHz
TOTAL HARMONIC DISTORTION	0.03% (8 OHMS) 0.09% (4 OHMS)
I.M. Distortion	0.03% (8 ohms)
(I.H.F. method, 60 Hz and 7 kHz mixed 4:1 at rated power output)	0.09% (4 ohms)
Damping Factor	60 (8 ohms, 20 Hz)
Sensitivity (at MAIN IN)	1.5 V
Impedance (at MAIN IN)	30 k ohms
Frequency Response for Power Amp Only	20 Hz ~ 20 kHz ±0.2 dB
Power Requirements	120 V AC 60 Hz
Dimensions	
Width	41.6 cm (16-3/8 inches)
Height	14.6 cm ( 5-3/4 inches)
Depth	30.2 cm (11-7/8 inches)
Weight	
Unit alone	14.1 kg (31 lbs.)
Packed for shipment	16 kg (35.2 lbs.)

#### FOR EUROPEAN MODEL ONLY

<b>Audio Section</b>	
POWER OUTPUT AT 1% DISTORTION	148 W
RATED POWER OUTPUT, 1 kHz	108 W
TOTAL HARMONIC DISTORTION AT RATED POWER OUTPUT, 1 kHz	0.09%
I.M. DISTORTION AT RATED POWER OUTPUT	
(I.H.F. METHOD, 300 Hz and 10 kHz MIXED 4:1 AT RATED POWER OUTPUT)	0.09%
POWER BANDWIDTH, ½ RATED POWER OUTPUT	7 Hz ~ 80 kHz
LOAD IMPEDANCE	4 OHMS
POWER OUTPUT AT 1% DISTORTION	122 W
RATED POWER OUTPUT, 1 kHz	86 W
TOTAL HARMONIC DISTORTION AT RATED POWER OUTPUT, 1 kHz	0.03%
I.M. DISTORTION AT RATED POWER OUTPUT	
(I.H.F. METHOD, 300 Hz and 10 kHz MIXED 4:1 AT RATED POWER OUTPUT)	0.03%
POWER BANDWIDTH, ½ RATED POWER OUTPUT	7 Hz ~ 80 kHz
LOAD IMPEDANCE	8 OHMS
Damping Factor, SP Output	
40 Hz	60
1 kHz	50
12.5 kHz	45
Frequency Response	
Main In ±1.5 dB	±0.2 dB
Signal-to-Noise Ratio, 1 kHz	
Main In	58 dB
Input Sensitivity, 1 kHz (Rated Input Voltage)	
Main In	1500 mV
Input Impedance, 1 kHz	
Main In	30 k ohms
Interchannel Crosstalk	
Main In 1 kHz	55 dB
250 Hz ~ 10 kHz	50 dB
Power Consumption	
Idling	60 W
Rated Power, 1 kHz	350 W
<b>General</b>	
Power Requirements	220 V ~, 50 Hz
	(E and N versions are featuring an external voltage selector for use on 110/120/240 V. Other versions can be converted by a qualified technician to operate on 110/120/240 V.)
Power Consumption at rated output, both channels operating	330 W
Idling Power	60 W
Semiconductor Complement	
Transistors	53
Diodes	49
Field Effect Transistors	4
Dimensions	
Panel Width	416 mm ( 16-3/8 inches)
Panel Height	146 mm ( 5-3/4 inches)
Depth	301 mm (11-27/32 inches)
Weight	
Unit alone	14.1 kg (31.1 lbs.)
Packed for shipment	16.0 kg (35.2 lbs.)



**marantz**

**MARANTZ CO., INC. · P. O. BOX 577 · CHATSWORTH, CALIFORNIA · 91311**



A WHOLLY-OWNED SUBSIDIARY OF SUPERSCOPE INC., CHATSWORTH, CALIFORNIA · 91311