

HiFi ENGINE®

For more Hi-Fi manuals and set-up information
please visit www.hifiengine.com

DC STEREO INTEGRATED AMPLIFIER

KA-7100

INSTRUCTION MANUAL



the sound approach to quality
KENWOOD

INTRODUCTION

The purpose of this manual is to acquaint you with the operating features of your new amplifier. You will notice that in every detail of planning, engineering, styling, operating convenience, and adaptability, we have sought to anticipate your needs and desires.

We suggest that you read this manual carefully. Knowing how to set up your amplifier, to the best advantage will enhance your listening pleasure right from the start. You will also become aware of the ease with which you can adjust your amplifier to meet your special requirements.

PRECAUTIONS CONCERNING INSTALLATION

- (a) Avoid locations subject to direct sunlight.
- (b) Avoid high or low temperature extremes.
- (c) Keep the amplifier away from heat radiating source.

SERIAL NUMBER

Record your SERIAL NUMBER on the spaces designated on the warranty card. You will find the serial number on the back of the unit.

AFTER UNPACKING

After unpacking, we recommend you inspect and examine the unit for any possible shipping damage. If your unit is damaged or fails to operate, notify your dealer immediately. If your unit was shipped to you directly, notify the shipping company without delay. Only the consignee (the person or company receiving the unit) can file a claim against the carrier for shipping damage.

We recommend you retain the original carton and packing materials to prevent any damage should you transport or ship your unit in the future.

WARNING:
TO PREVENT FIRE OR SHOCK HAZARD, DO NOT EXPOSE THIS APPLIANCE TO RAIN OR MOISTURE.

NOTES

1. Units shipped to the U.S.A. and CANADA are designed to be operated with 120 volts AC only. Units shipped to the Scandinavian countries are designed to be operated with 220 volts AC only. Therefore the above units are not equipped with an AC Voltage Selector Switch so all reference to such a switch throughout this manual should be disregarded.
2. Units shipped to all other countries are equipped with an AC Voltage Selector Switch on the rear panel that is preset at the factory to the voltage generally available in the destination area.

AC VOLTAGE SELECTION

The KA-7100 operates on 110 ~ 120 volt or 220 ~ 240 volt AC. The AC Voltage Selector Switch on the rear panel is set to the voltage that prevails in the area to which the amplifiers are shipped. Before operating this unit, make sure that the position of the AC Voltage Selector Switch matches your line voltage. If not, it must be changed to the proper setting.

To change, first disconnect the AC line cord. Then remove the stopper plate and slide the AC Voltage Selector Switch to the opposite side. Then reattach the stopper plate to the other side.

Note:

Our warranty does not cover damage caused by excessive line voltage due to improper setting of the AC Voltage Selector Switch.

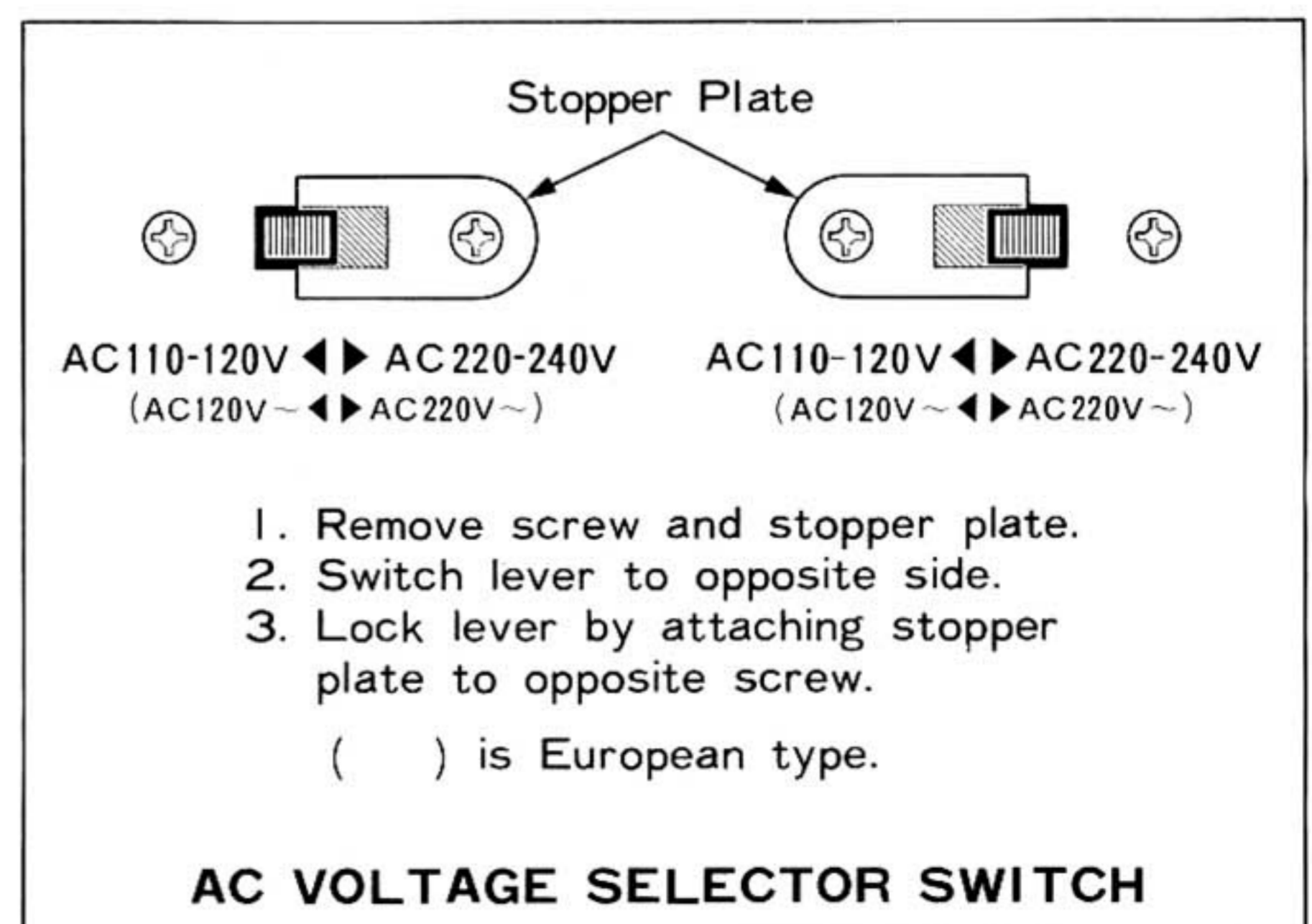

CONTENTS

FEATURES	3
INTERCONNECTING DIAGRAM	4
CONNECTING INSTRUCTIONS	6
CONTROLS AND THEIR FUNCTIONS	8
OPERATING INSTRUCTIONS	10
TECHNICAL DESCRIPTION	12
BLOCK DIAGRAM	13
POINTS TO BE CHECKED PRIOR TO SERVICING	14
SPECIFICATIONS	15

FEATURES

1. Newly incorporated DC power amplifier* designed by Kenwood offers extremely low distortion and phase characteristics particularly in the range of very low frequencies. Since a good transient response characteristic is assured, output wave forms can be taken out without impairing the original wave forms of input. The quality of reproduced sound is very high.

* Refer to page 12 regarding technical descriptions of the DC power amplifier.

2. Because of the adoption of right and left separate power supplies, each independent of the other, *dynamic crosstalk distortion* is eliminated and excellent reproduction is achieved with stable acoustic image.
3. Continuous power output is 60 watts per channel, minimum RMS, at 8 ohms from 20 Hz to 20,000 Hz with no more than 0.02% total harmonic distortion.
4. Since an FET differential circuit is adopted in the first stage, the equalizer circuit assures a low distortion factor and a high S/N ratio.
5. A BAX type low-distortion tone control and a tone defeat switch designed to make up highly qualified sound are provided.
6. An ATT type master volume control (32 contacts) is provided. It is carefully designed to reduce interlock errors to a minimum.
7. Multi-Function Attenuator Switch
This lever instantly cuts the level by 20 dB.

For greater control with the large level control, simply activate this lever and you will find precise level adjustment easier and quicker. In addition, this switch is practical when answering the telephone or to placate an unappreciative guest.

8. A 2-stage loudness control is very convenient for low-frequency correction.
9. Convenient tape switch with through circuit for two tape decks.
10. Kenwood's excellence of design and superior craftsmanship is evident not only in the electronics of the KA-7100 but also in all the controls.

INTERCONNECTING DIAGRAM

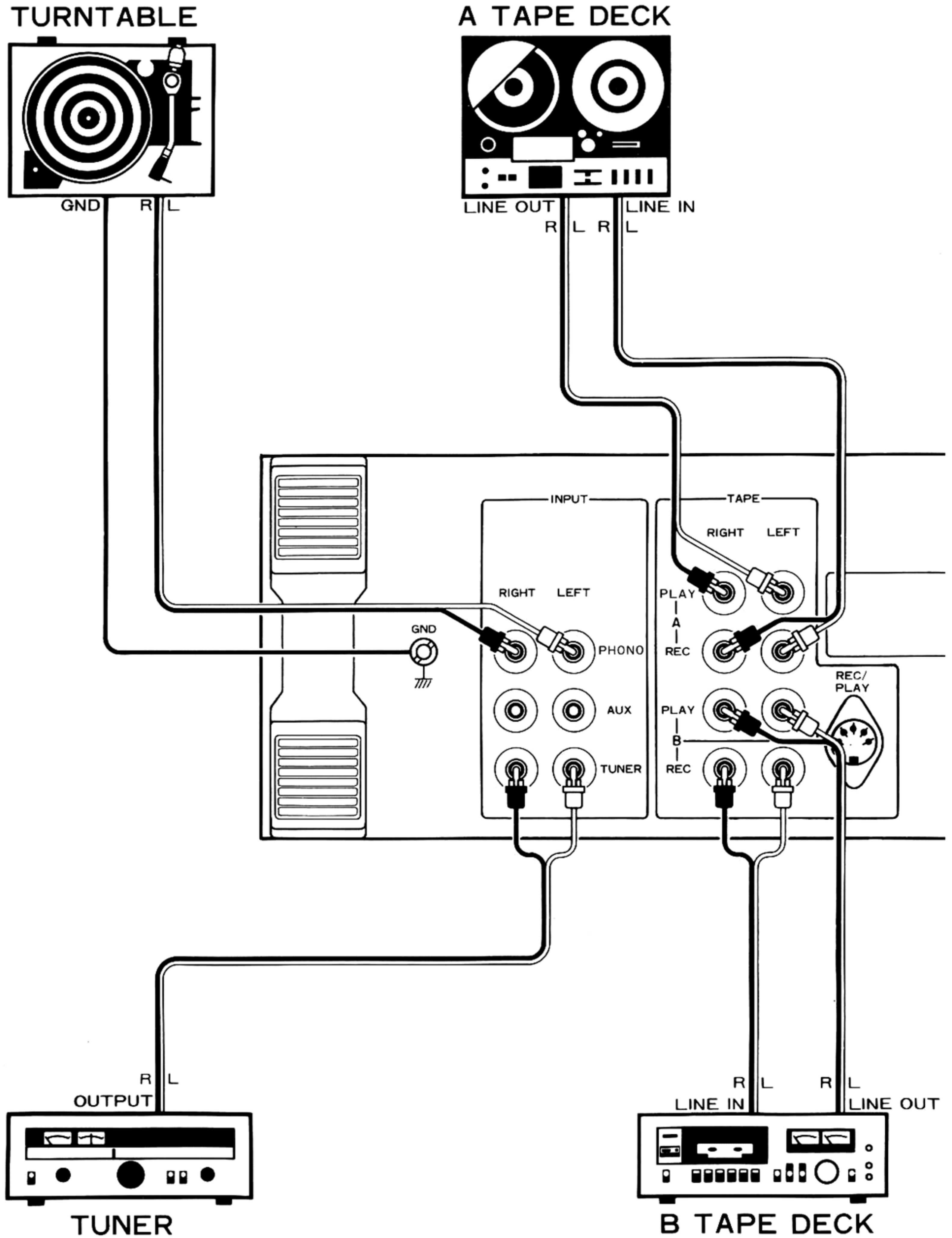

INTERCONNECTING DIAGRAM

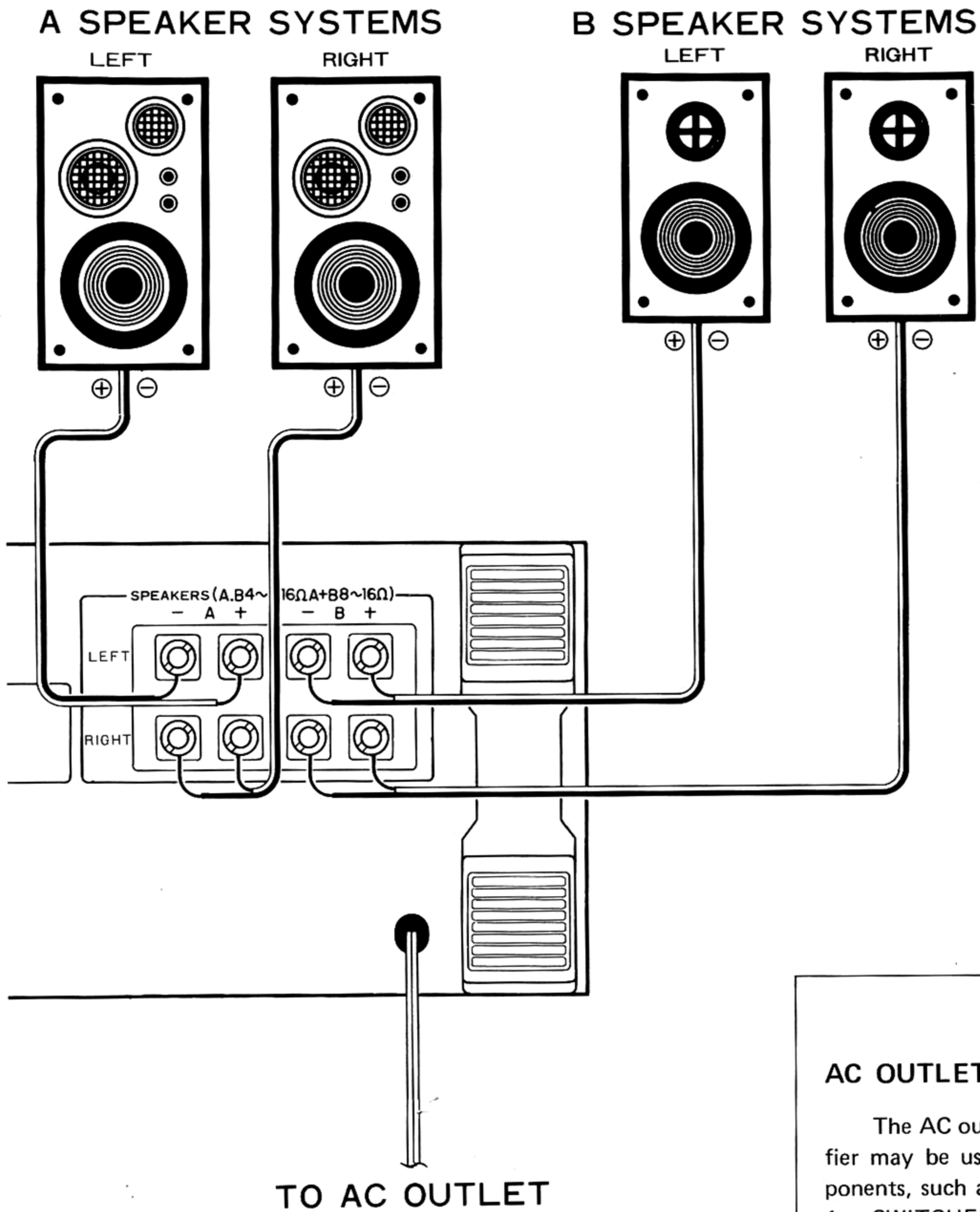

AC OUTLETS

The AC outlets on the rear panel of the amplifier may be used to supply power to other components, such as a turntable, tape deck, etc.

1. **SWITCHED** outlets
These outlets are controlled by the POWER switch on the front panel. (The total capacity is 100 watts maximum.)
2. **UNSWITCHED** outlet
This outlet delivers power at all times. (The capacity is 300 watts maximum.)

Notes:

1. Units shipped to the European countries are not equipped with the AC OUTLETS.
2. Do not connect any equipment whose power consumption exceeds the capacity of each outlet.

CONNECTING INSTRUCTIONS

SPEAKER CONNECTING AND SPEAKER SWITCH

In connecting only one set of speakers, connect the right speaker to right speaker terminals and left speaker to left speaker terminals of "A" speaker terminals. Should plus or minus of either right or left channel be reversely connected, sounds at the center section will be adversely affected by lack of separation. To connect additional set of speakers, connect right speaker to right speaker terminals and left speaker to left speaker terminals of "B" speaker terminals.

When connecting the speaker leads to the speaker terminals, make sure that the bare wire strands at the ends of the speaker leads do not touch each other or adjacent terminal.

It is recommended that the tips of the speaker cord leads are soldered, or the strands of each individual lead twisted together to eliminate any possibility of short-circuits forming in the speaker connecting network.

Note:

When only one pair of loudspeakers are used, please ensure that the impedance of each speaker system is 4 ohm or more. When two sets of speaker systems are being used at the same time (A+B), please ensure that the impedance of each speaker system is 8 ohm or more.

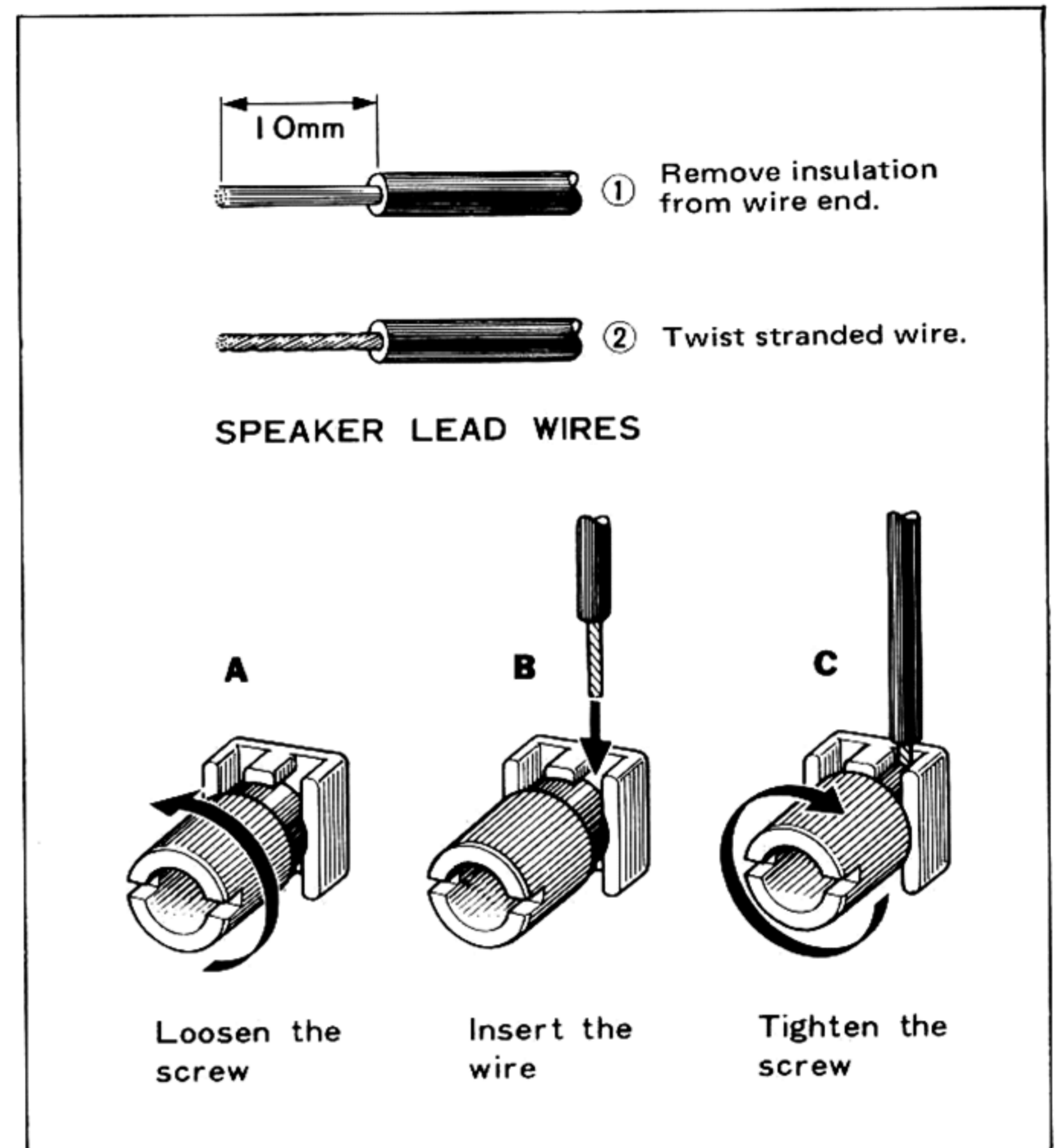

PHASING OF THE SPEAKERS

Speaker phasing can be determined in the following manner:

1. Set the MODE switch to MONO.
2. Set the INPUT SELECTOR switch to PHONO, and adjust the VOLUME control to the desired listening level.
3. Play a familiar record.
4. If the sound is coming directly from the front, the speakers are in phase. If the sound comes from both sides and there is a noticeable loss in low frequencies, the speakers are out of phase. In this case reverse the leads on one speaker.

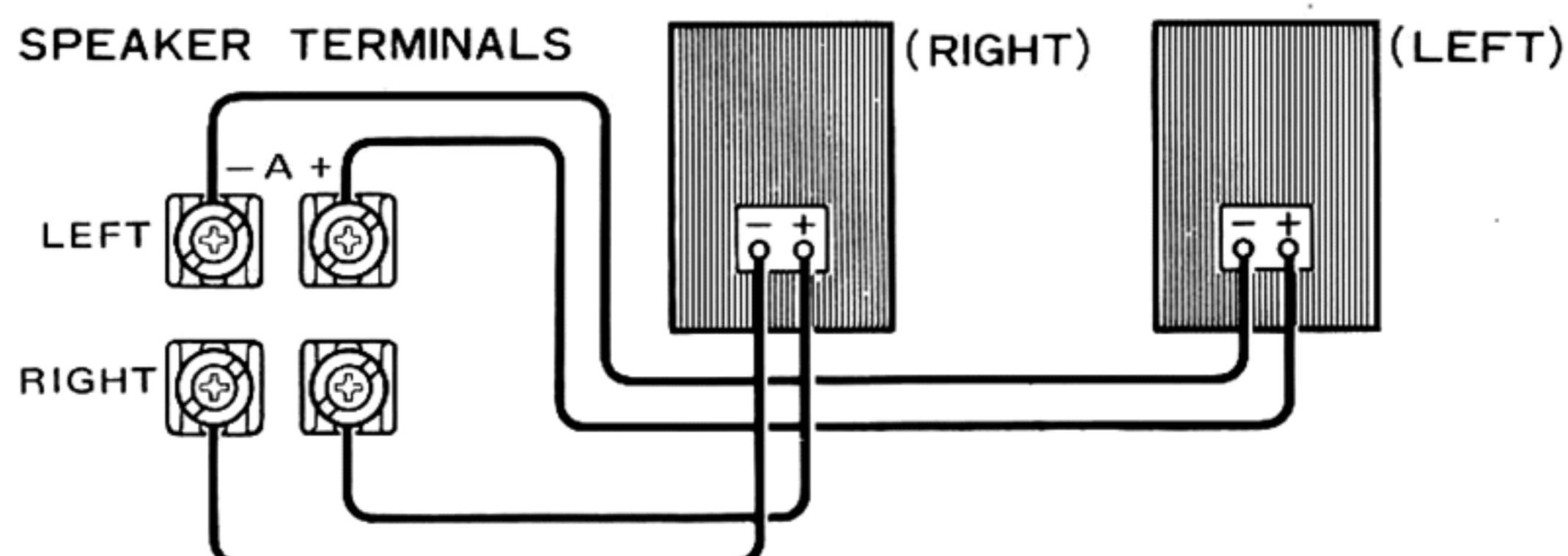

CONNECTING INSTRUCTIONS

TURNTABLE CONNECTION

The two shielded audio cables from your stereo turntable are normally terminated with phono plugs. Connect the left channel of the turntable to "LEFT" of the INPUT PHONO jack and the right channel to "RIGHT" of the INPUT PHONO jack. If the turntable has a grounding wire, connect it to the unit's GND terminal to avoid hum.

AUX JACKS CONNECTION

High level INPUT AUX jacks are for miscellaneous sources, such as extra tape decks, additional tuners and/or receivers, TV sound outputs, and other external components.

TAPE DECK CONNECTION

Recording

A tape deck can be connected for recording as follows: the left channel input of the tape deck to "LEFT" of the TAPE A REC jack, the right channel input of the tape deck to "RIGHT" of the TAPE A REC jack.

Playback

A tape deck can be connected for playback as follows: the left channel output of the tape deck to "LEFT" of the TAPE A PLAY jack, the right channel output of the tape deck to "RIGHT" of the TAPE A PLAY jack.

Second Tape Deck

If the second tape deck is connected, similar connections must be provided to the TAPE B jacks.

DIN CONNECTOR (REC/PLAY CONNECTOR)

If your tape deck is equipped with a DIN connector, connect it to the TAPE B REC/PLAY connector with a DIN connecting cord. A DIN connector enables recording and playback with this single cord.

Note:

The DIN connector corresponds to the TAPE B PLAY and TAPE B REC jacks — the signal must be controlled with the TAPE switch on the front panel. When a DIN cord is connected, the TAPE B PLAY and TAPE B REC jacks should not be used.

TUNER CONNECTION

Use the TUNER terminals for connection to an FM stereo or AM-FM stereo tuner. Connect the left channel of the tuner to "LEFT" of the INPUT TUNER jack and the right channel of the tuner to "RIGHT" of the INPUT TUNER jack.

TURNTABLE

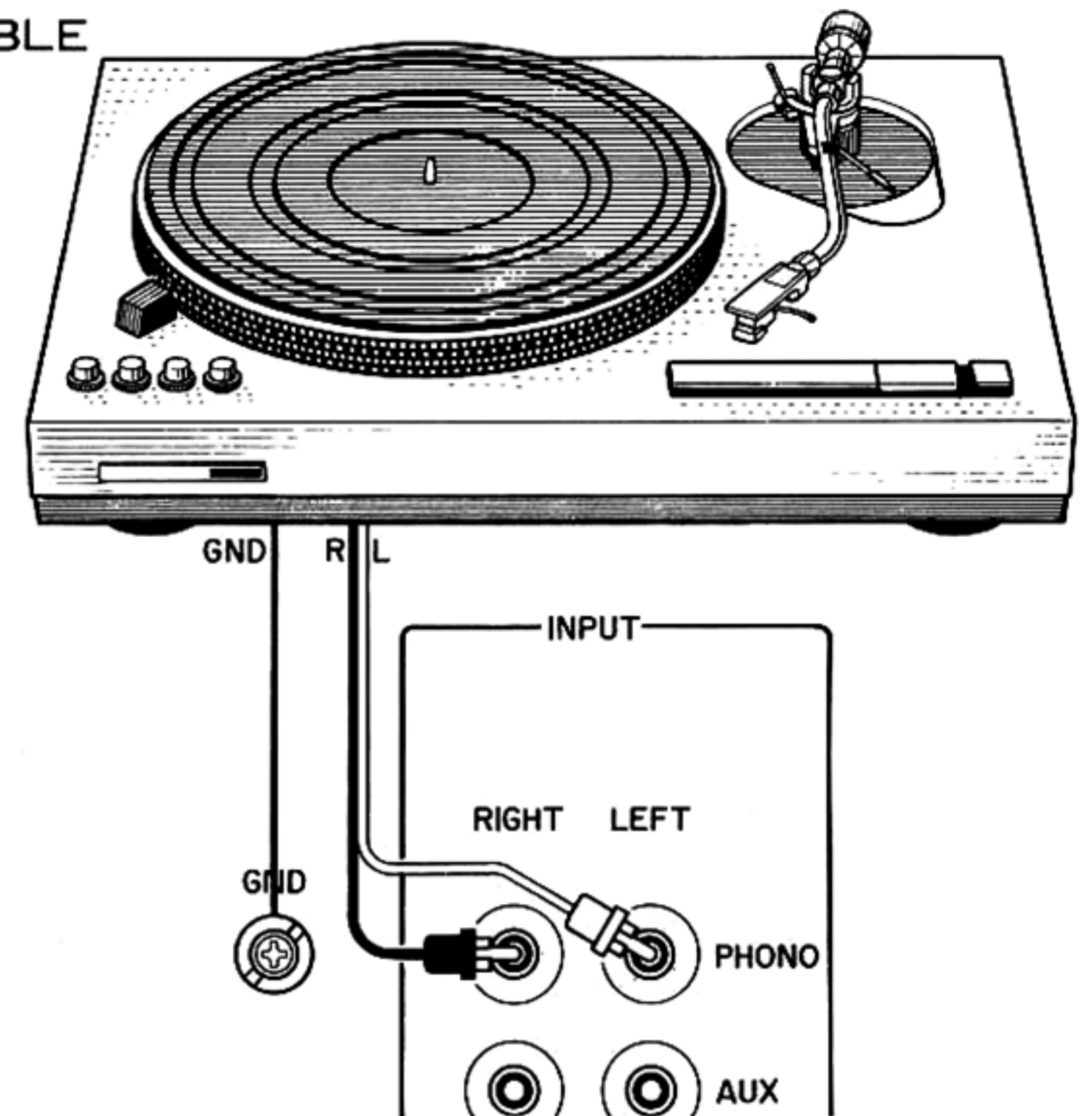

TAPE DECK

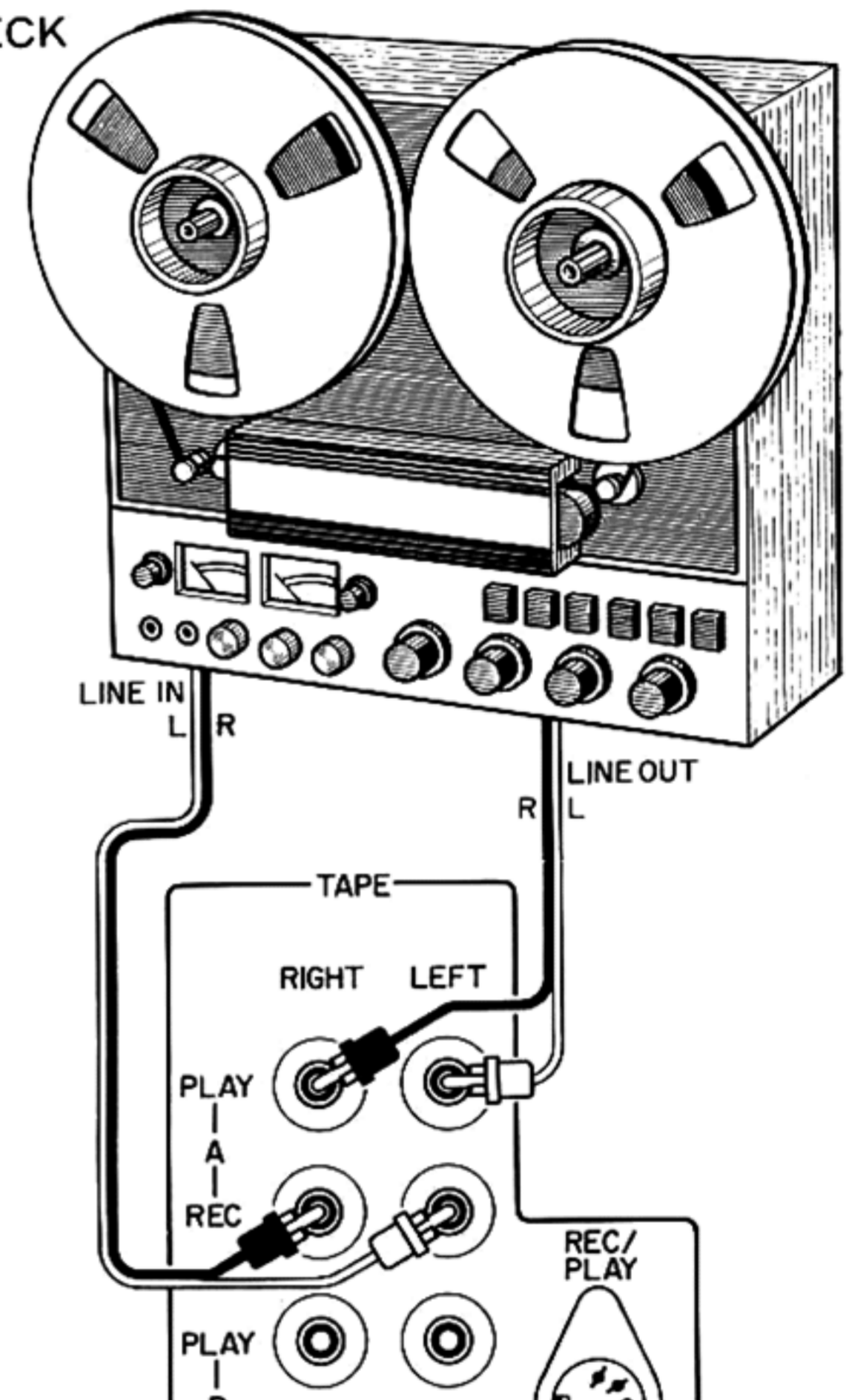

TUNER

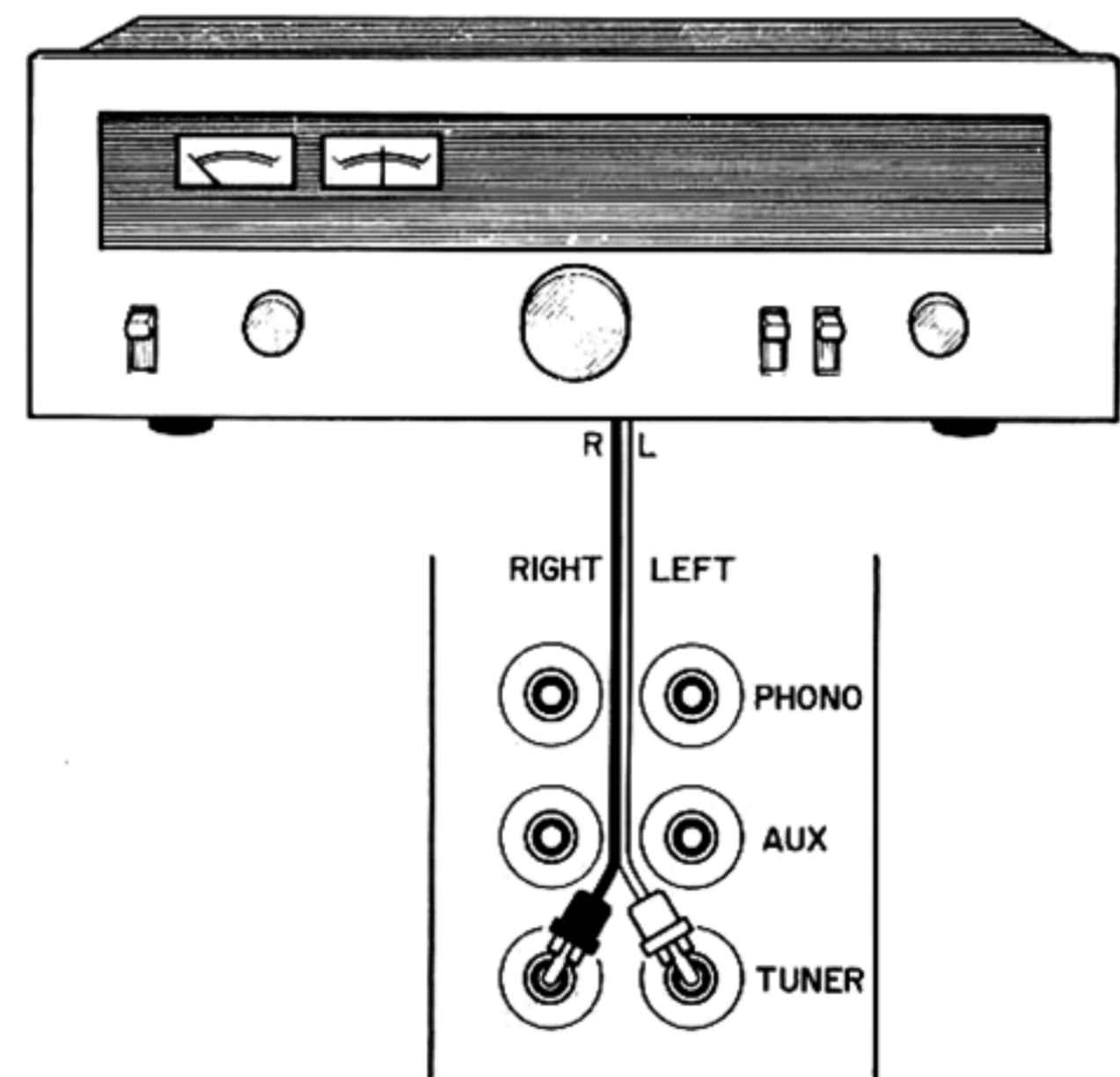

CONTROLS AND THEIR FUNCTIONS

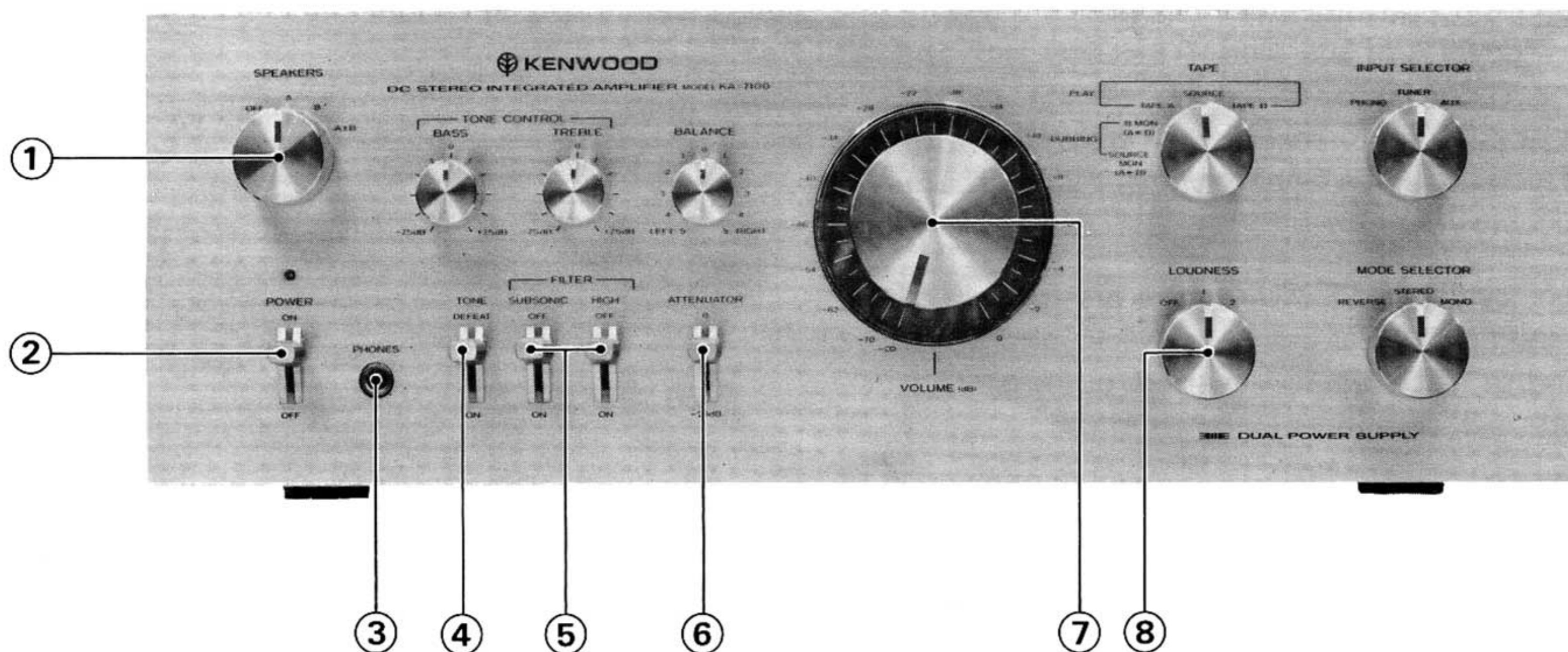

① SPEAKERS switch

OFF – This position silences all speakers for private headphones listening.

A – Activates speakers connected to the "A" speakers terminals on the rear panel.

B – Activates speakers connected to the "B" speaker terminals on the rear panel.

A+B – Activates simultaneously two sets of speaker systems connected to the "A" and "B" speaker terminals.

② POWER switch

ON – This position turns the amplifier on. The pilot lamp lights when the power is on. Also controls the AC outlet marked SWITCHED on the rear panel.

OFF – This position turns the amplifier off.

③ PHONES jack

Plug a stereo headphones into this jack. For private listening through headphones, set the SPEAKERS switch to the OFF position.

④ TONE switch

In position DEFEAT, the bass and treble controls do not function. By switching between DEFEAT and ON, this enables you making frequency response measurements of phono cartridges, loudspeakers and the acoustic conditions of the room.

⑤ FILTER switches

SUBSONIC – Frequencies below 20 Hz are attenuated by 6 dB/octave. Although such subsonic frequencies are inaudible to the human ear, they can cause intermodulation distortions and even damage to the loudspeakers. It is recommendable to set the button ON at all times, even if no record rumble etc. is heard.

OFF – No attenuation of subsonic frequencies.

HIGH – Setting this switch to ON reduces any high frequency noise, such as tape hiss, record scratch, etc.

Frequencies above 8 kHz are attenuated by 6 dB/octave.

⑥ ATTENUATOR switch

Set to -20 dB to attenuate the audio output by 20 dB. This convenient feature saves having to disturb the VOLUME control, for example, when answering the telephone.

⑦ VOLUME control

Adjusts output level to speakers and headphones. Scale is graduated in dB, and when used in conjunction with the ATTENUATOR, fine adjustment can be obtained.

⑧ LOUDNESS Switch

The LOUDNESS switch boosts bass response to compensate for the human ear's lack of response to those frequencies at low volume levels.

Set it to your own most satisfactory listening level.

Switch positions and functions are as follows:

"OFF" Flat

"1" +3 dB at 100 Hz

"2" +6 dB at 100 Hz

CONTROLS AND THEIR FUNCTIONS

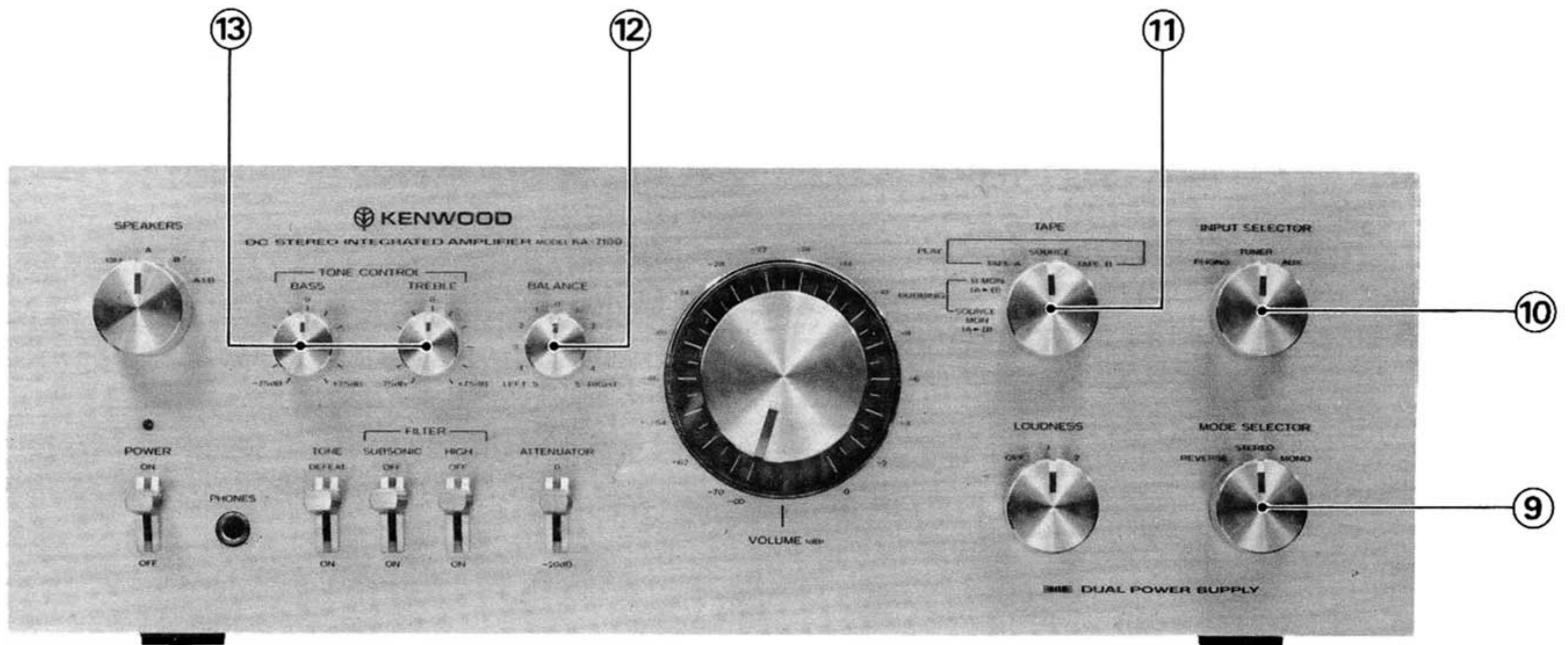

⑨ MODE SELECTOR switch

Switch positions and functions are as follows:

STEREO — This provides stereo reproduction of any stereo program source. The left channel is heard from the left speaker, and the right channel is heard from the right speaker.

REVERSE — Stereo reproduction with reversed channels: left channel to right speaker, right channel to left speaker.

MONO — Mono reproduction. The left and right channels are mixed together and heard from both speaker.

⑩ INPUT SELECTOR switch

Switch positions and functions are as follows:

PHONO — In this position the turntable is available if connected to the PHONO input jacks on the rear panel.

TUNER — In this position the tuner is available if connected to the TUNER input jacks on the rear panel.

AUX — Selects source connected to the AUX jacks.

⑪ TAPE switch

Switch positions and functions are as follows:

PLAY: _____

SOURCE — The source signal is heard.

TAPE A — For monitoring a recording or for playback on a tape deck connected to the TAPE A jacks.

Sound recorded on the tape is heard.

TAPE B — For monitoring a recording or for playback on a tape deck connected to the TAPE B jacks.

Sound recorded on the tape is heard.

DUBBING: _____

B MON (A ► B) — For dubbing from a tape deck connected to the A TAPE jacks into a tape deck connected to the B TAPE jacks. The recording condition of the B tape deck can be monitored.

SOURCE MON (A ► B) — Parallel with the tape dubbing operation (A ► B), this position makes it possible to reproduce simultaneously from the loudspeakers other program sources selected by the INPUT SELECTOR switch such as an FM broadcast or phono disc reproduction.

⑫ BALANCE control

This BALANCE control adjusts unequal volume from any program source in right and left channels. The left channel is accentuated when this adjuster is turned from center "0" toward the left side, and conversely.

⑬ TONE controls

The BASS and TREBLE controls are for adjusting the bass and treble response. This is a click step type control. Turning the controls clockwise increases bass and treble response and counterclockwise decreases bass and treble response. Bass and Treble controls do not function when the TONE switch is set to DEFEAT.

OPERATING INSTRUCTIONS

Prior to turning on the unit, set each selector, switch and control as below:

- SPEAKERS —————▶ OFF, A, B or A+B
- BASS, TREBLE —————▶ 0
- BALANCE —————▶ 0
- TONE —————▶ ON
- FILTER —————▶ OFF
- ATTENUATOR —————▶ 0
- VOLUME —————▶ — ∞
- TAPE —————▶ SOURCE
- LOUDNESS —————▶ OFF
- MODE SELECTOR —————▶ STEREO

FM AND AM RECEPTION

1. Set the INPUT SELECTOR switch to TUNER.
2. Operate the tuner.
3. Adjust the volume and the tonality.

TURNTABLE OPERATION

1. Set the INPUT SELECTOR switch to PHONO.
2. Operate the turntable.
3. Adjust the volume and the tonality.

AUX JACKS UTILIZATION

1. Set the INPUT SELECTOR switch to AUX.
2. Operate the component connected.
3. Adjust the volume and the tonality.

TAPE DECK OPERATION

PLAYBACK

1. Set the TAPE switch to TAPE A or TAPE B in accordance with the tape deck to be operated. The INPUT SELECTOR switch can be in any position.
2. Operate the tape deck.
3. Adjust the volume and the tonality.

TAPE MONITORING

If you use the unit with 3-head type tape decks, you can check the sound quality of the recording by momentarily comparing the recorded sound with the source sound as follows:

- Set the TAPE switch to TAPE A or TAPE B to monitor the recorded sound.
- Set the TAPE switch to SOURCE to monitor the source sound before recorded.

WHEN RECORDING WITH ONE TAPE DECK

1. Set the INPUT SELECTOR switch to the desired program source.
2. Set the selected program source in operation.
3. Operate the tape deck. Recording level should be adjusted with its volume control.

Note:

Recording is not affected by the unit's controls and switches such as BASS, TREBLE, BALANCE, TONE, FILTER, ATTENUATOR, VOLUME and LOUDNESS.

WHEN RECORDING WITH TWO TAPE DECKS

1. Set the INPUT SELECTOR switch to the desired program source.
2. Set the selected program source in operation.
3. Operate two tape decks. Recording levels should be adjusted with their volume controls. To monitor the recording, set the TAPE switch to TAPE B. It is impossible to monitor the recording in the tape deck A when recording with two tape decks.

Note:

When recording with two tape decks, a source signal cannot be recorded in the tape deck B if the TAPE switch is set to TAPE A. Therefore, be sure to set the TAPE switch to SOURCE or TAPE B only.

OPERATING INSTRUCTIONS

Tape-to-Tape Dubbing

Tape recordings can be easily duplicated from one tape deck to another with minimal loss of quality by the following procedure.

1. Set the TAPE switch to B MON (A ► B) when you wish to make dubbing, monitoring the sound duplicated on the tape deck B. Meantime, set the TAPE switch to SOURCE MON (A ► B) when you wish to make dubbing, listening to a different source sound such as an FM broadcast, record, etc.

Note:

The INPUT SELECTOR switch can be in any position in both cases.

2. Load the recorded tape on the tape deck A, and another tape for re-recording, on the tape deck B.
3. Operate both tape decks together.

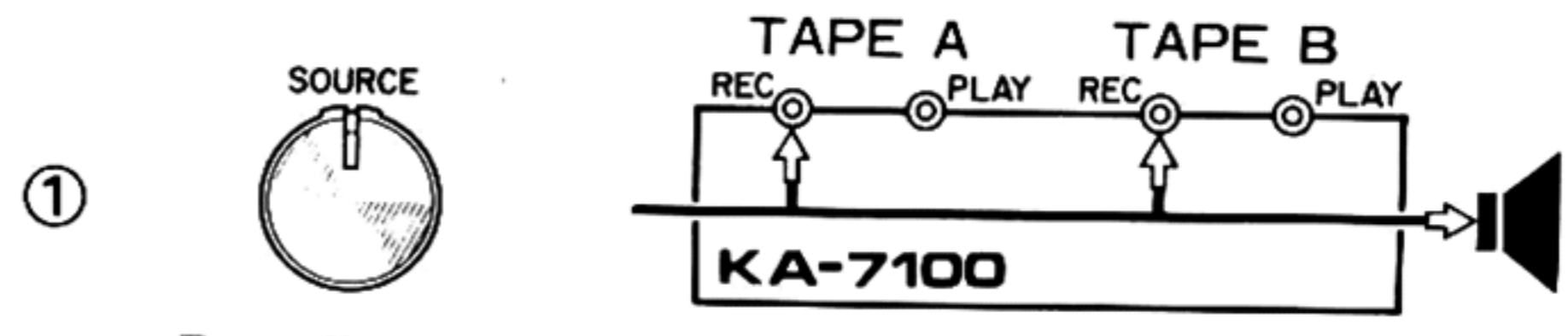
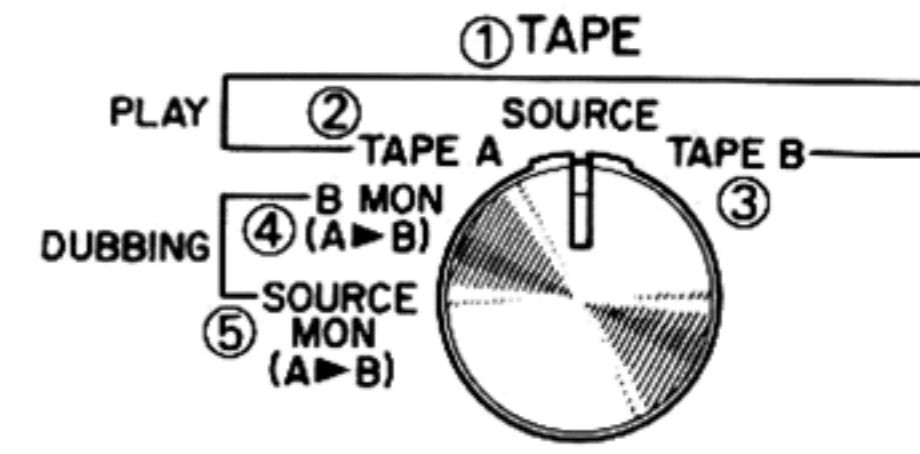

Recording: The input signal selected by the INPUT SELECTOR switch is always present at a fixed level at the TAPE A & TAPE B REC jacks.

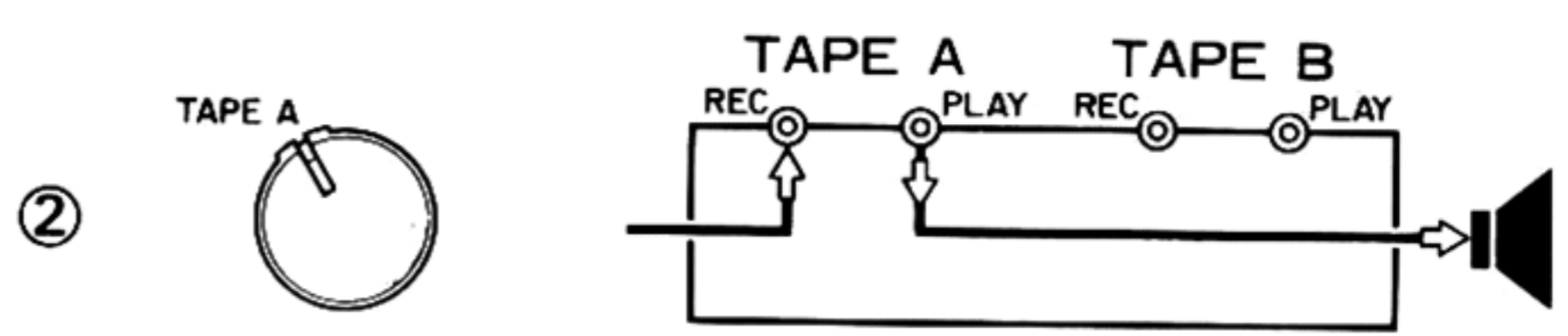

Playback: The playback signal enters TAPE A PLAY jacks and is heard from the speakers.

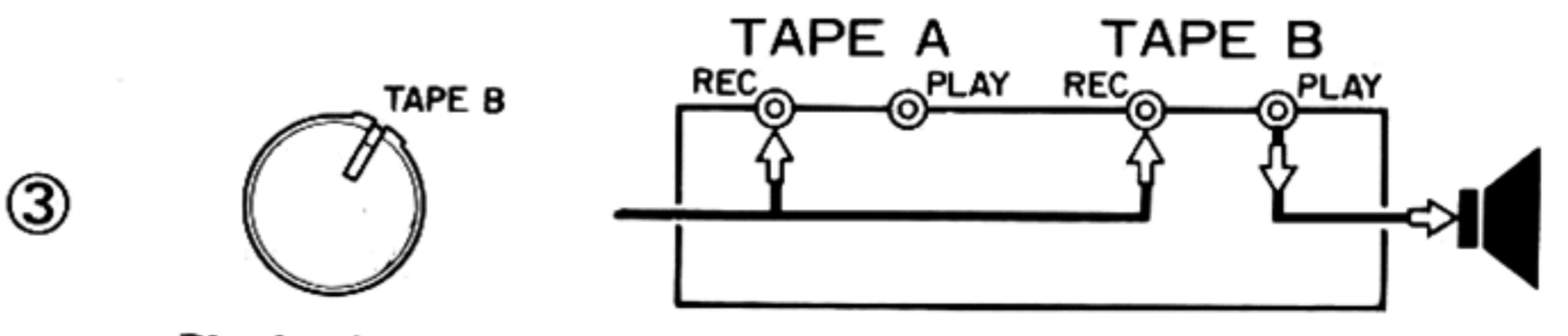

Playback: The playback signal enters TAPE B PLAY jacks and is heard from the speakers.

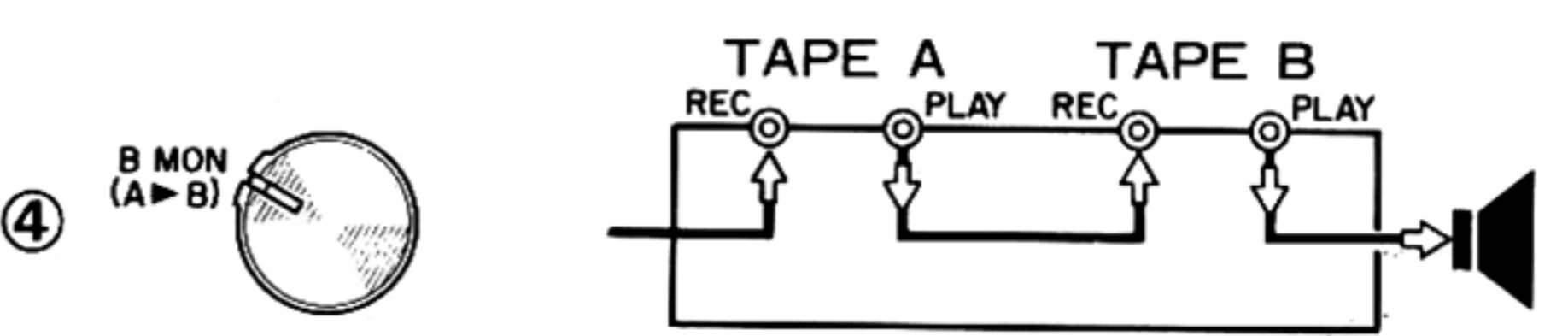

Dubbing: The playback signal from tape deck A enters via TAPE A PLAY jacks, passes through TAPE switch B MON (A ► B), and is recorded by tape deck B.

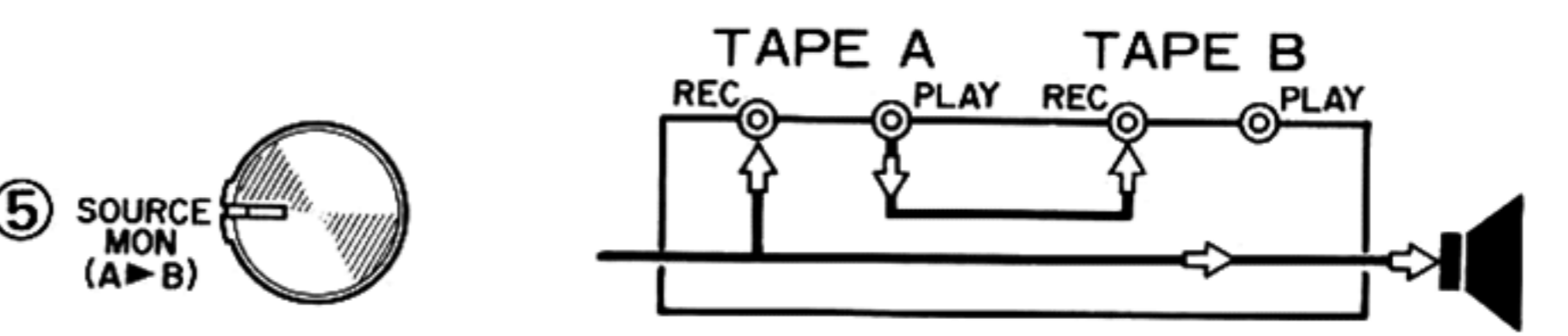

Dubbing: The playback signal from tape deck A enters via TAPE A PLAY jacks, passes through TAPE switch SOURCE MON (A ► B), and is recorded by tape deck B. In addition, this position makes it possible that a different source signal such as an FM broadcast or phono disc is reproduced through the speakers.

TECHNICAL DESCRIPTION

DC POWER AMPLIFIER

In many ways the direct current (DC) amplifier is the ideal amplifier for audio use. Kenwood audio engineers have taken up the challenge of producing this ideal amplifier. The result has been success in producing a power amplifier which makes this dream come true.

Characteristics of DC Amplifiers

1. They make reproduction of low frequencies down to subsonic and DC levels possible. The result is to give a greater sense of power in the audio reproduction which greatly increases enjoyment of music and reproduces the low-frequency high-energy sounds of a live performance as only a DC amplifier can.
2. There is zero phase difference between input and output. Because there are no capacitors in the signal path to cause phase rotation,

phase distortion is absent.

3. Output waveform is a faithful duplication of the input waveform. Although this would seem to be a natural prerequisite for a hi-fi amplifier, it is a fact that only a DC amplifier makes faithful duplication possible.

The performance of a DC amplifier depends upon the stability of each individual circuit within it. In the input stage, special dual FETs are used, intended for the most demanding electronic computer applications (in packs of perfectly balanced pairs). This is followed by a three-stage differential amplifier operating in Class A, in which the open loop gain is high, and in which a fully adequate degree of negative feedback is applied with a pre-driver load circuit in which the power transistor bias is stabilized by a constant current supply circuit. This circuit configuration gives excellent stability and extremely wide frequency response.

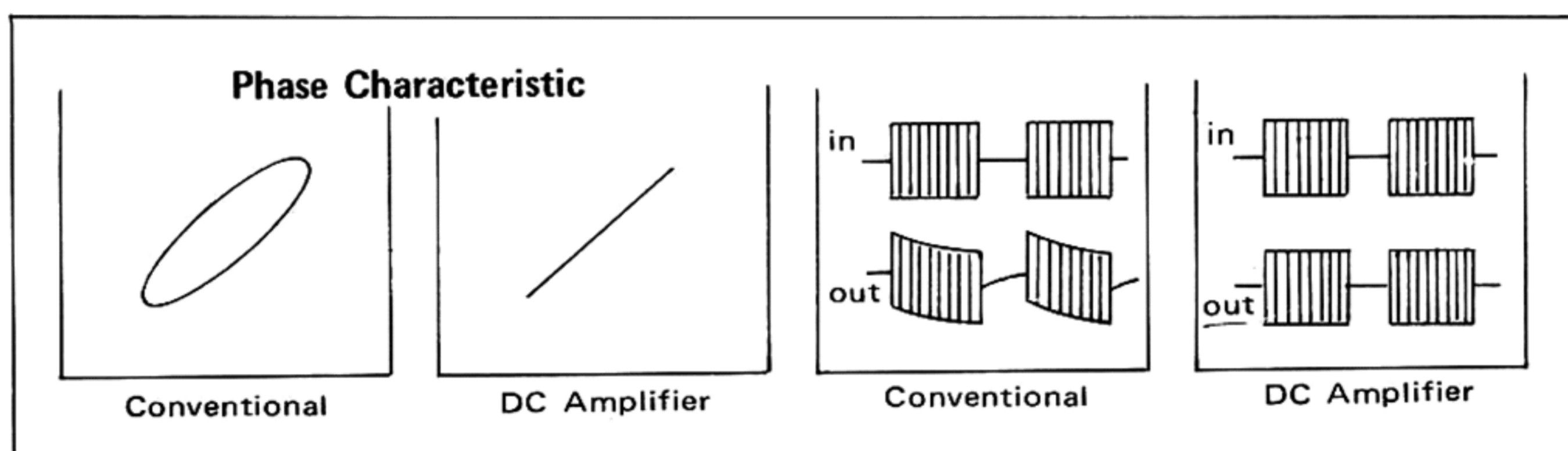

PRECAUTIONS FOR SAFETY

- Switch off the unit and disconnect the power plug from your AC outlet immediately if the abnormality (smell, smoke, etc.) should take place.
- When you connect or disconnect the power plug from your AC outlet, never do it with wet hands to avoid unexpected accident from electric shock. Besides, do it by holding the power plug itself, not the power cord.
- Disconnect the power plug from your AC outlet when it begins to thunder terrifically. Also, disconnect the feeder or coaxial cable for an outdoor antenna from the tuner, if used together with the unit. Do not touch the feeder or coaxial cable disconnected then.
- It is desirable to disconnect the power plug from your AC outlet when you leave your house for a long time.
- Never dismantle the case from the unit and touch the internal part. Never modify the internal part. Otherwise, the danger of electric shock will be incurred.
- The power cord must not be pulled strongly, nor bent forcibly, nor scratched, nor extended by connecting an extra cord. This will damage the cord and be a cause of electric shock and a fire.
- Do not put a heavy thing on the power cord.
- Do not put on and near the unit what contains water such as a vase, pitcher, etc.
- Do not put the inflammable (paper, celluloid, etc.) and the metal (needle, hairpin, coin, etc.) in the unit.
- Never close the ventilation holes on the case top with a table cloth, curtain, etc. Nothing must be put on the unit especially when using for a long time.

BLOCK DIAGRAM

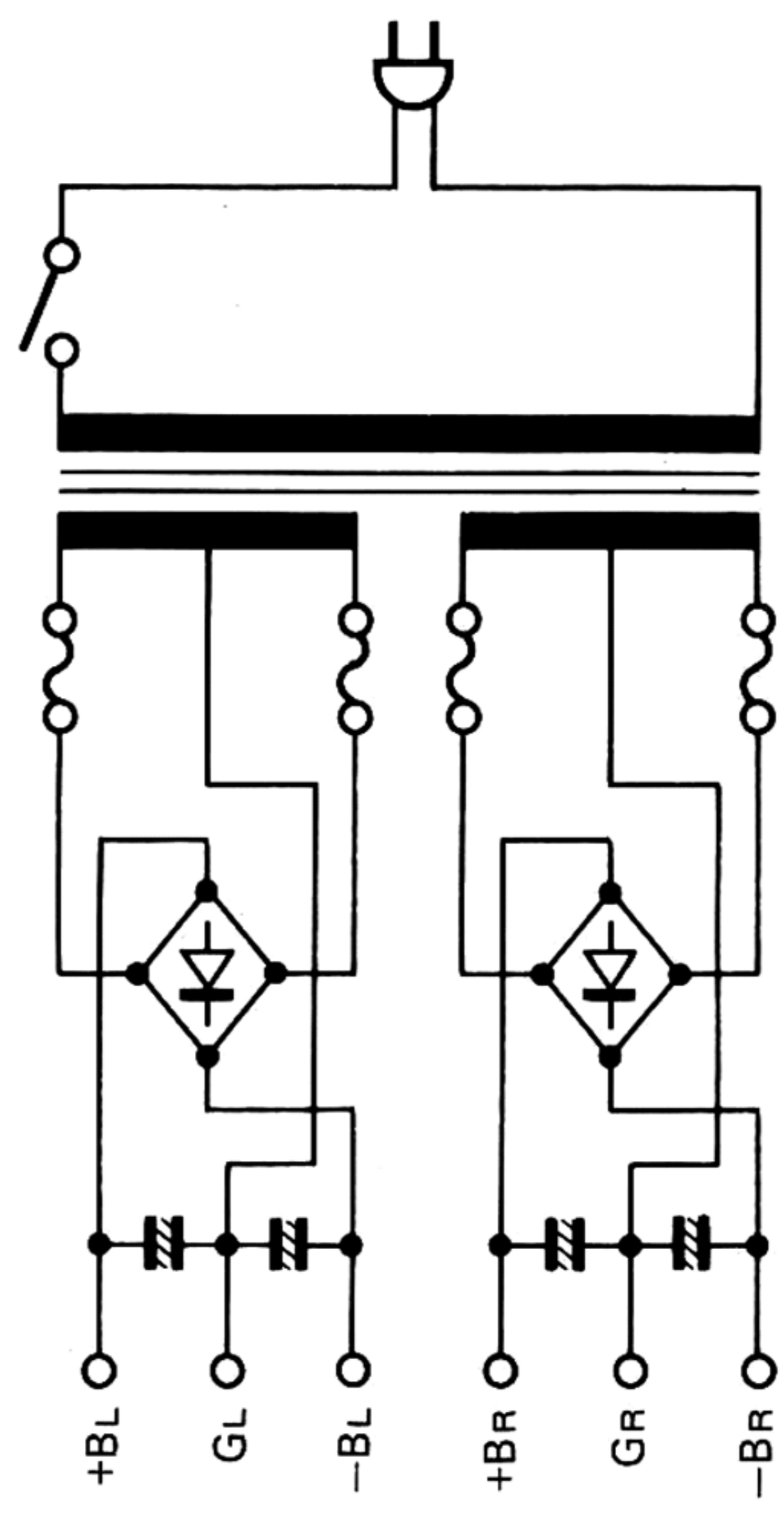
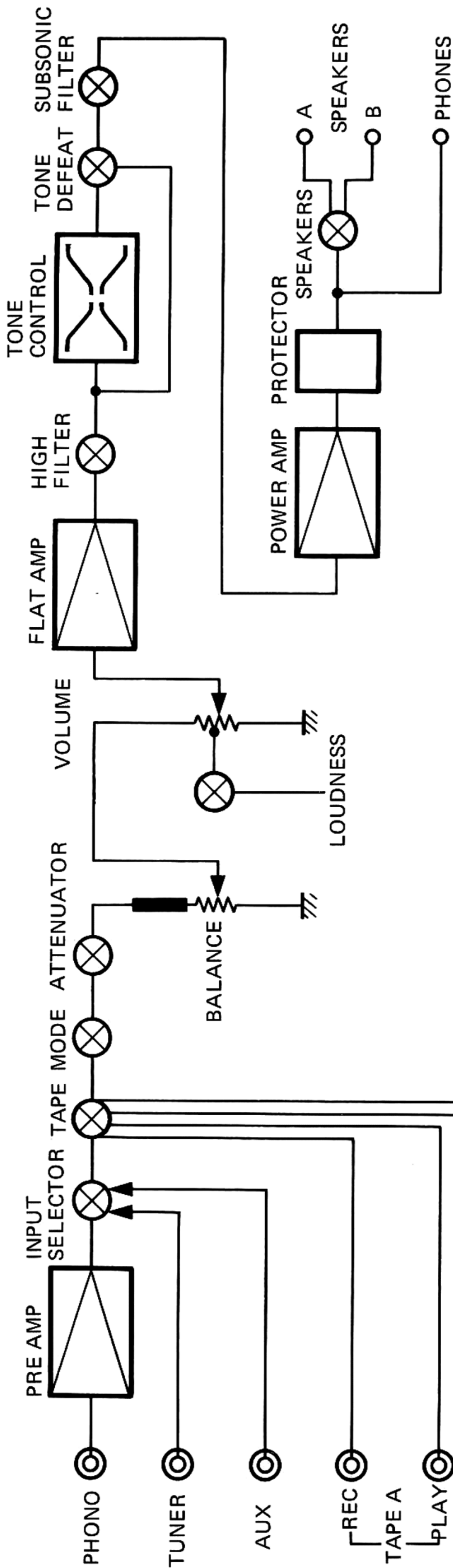

POINTS TO BE CHECKED PRIOR TO SERVICING

In initially installing this amplifier improper connections to a tuner or turntable may result in one of the following indications of trouble. Their possible causes and corrective measures are listed below to facilitate installation.

SYMPTOM	PROBABLE CAUSE	CORRECTION
No pilot lamp indication, no sound although AC is switched ON.	Poor AC plug connection.	Check plug contact.
No sound from LEFT and RIGHT.	<ul style="list-style-type: none"> a) Speaker cords disconnected. b) SPEAKERS switch set to OFF position. c) Volume Control (extreme left). d) TAPE switch at TAPE A or TAPE B position. 	<ul style="list-style-type: none"> a) Check connections from amp. output to speakers. b) SPEAKERS switch should be switched to OFF only when using stereo headphones. c) Set to appropriate volume level. d) Always set to SOURCE except when using tape decks.
Sound only from one side.	<ul style="list-style-type: none"> a) Poor speaker cord connections. b) BALANCE control set to one extreme or other. 	<ul style="list-style-type: none"> a) Check amp. output and speakers connections. b) Adjust BALANCE control.
Difference in volume level of radio and phono.	Difference in received signal and phono output levels.	Set to appropriate volume level.
No sound from LEFT and RIGHT, or sound only from one side.	Turntable output cord disconnected.	See that turntable output cord is firmly plugged into amp. input.
Loud hum drowns out sound.	Poor turntable output cord prong connections.	See that turntable output cord is firmly plugged into amp. input.
Sound audible but background hum occurs.	<ul style="list-style-type: none"> a) Turntable output cord picking up hum from AC cord. b) Turntable not grounded. 	<ul style="list-style-type: none"> a) Keep turntable output cord away from AC cords. Choose cord paths which keep hum at a minimum. Reverse turntable AC plug connections. b) Connect ground wire to GND terminal.
Sound audible but continuous background buzz interferes.	TV signal picked up by Turntable output cord. Frequency occurs near TV transmitting antenna.	Route turntable cord so that hum is minimized.
Howling noise occurs when volume is raised or bass response is increased.	Speaker vibrations induce feedback in Pickup.	Increase distance between turntable and speakers. Choose speaker locations carefully. Remember, loose flooring induces howling.

SPECIFICATIONS

POWER AMPLIFIER SECTION

POWER OUTPUT

60 watts* per channel, minimum RMS, at 8 ohms from 20 Hz to 20,000 Hz with no more than 0.02% total harmonic distortion.

Both Channel Driven	60 + 60 watts 8 ohms at 1,000 Hz 80 + 80 watts 4 ohms at 1,000 Hz
Dynamic Power Output	250 watts 4 ohms
Total Harmonic Distortion	0.02% at rated power into 8 ohms 0.02% at 1 watt into 8 ohms
Intermodulation Distortion (60 Hz : 7 kHz = 4 : 1)	0.01% at rated power into 8 ohms 0.01% at 1 watt into 8 ohms
Power Bandwidth	5 Hz to 45,000 Hz
Frequency Response	D.C. to 100,000 Hz +0 dB, -1.5 dB
Signal to Noise Ratio	120 dB (short circuited)
Damping Factor	50 at 8 ohms
Speaker Impedance	Accept 4 ohms to 16 ohms

PRE AMPLIFIER SECTION

Input Sensitivity/Impedance/Signal to Noise Ratio (IHF A curve)

Phono	2.5 mV/ 50 k ohms/ 80 dB
Tuner	150 mV/ 50 k ohms/ 110 dB
AUX	150 mV/ 50 k ohms/ 110 dB
Tape	150 mV/ 50 k ohms/ 110 dB
Maximum Input Level for Phono	200 mV (rms), T.H.D. 0.02% at 1,000 Hz
Output Level/Impedance	
Tape REC (Pin)	150 mV/ 450 ohms
(DIN)	30 mV 80 k ohms
Frequency Response	
Phono	RIAA standard curve +0.2 dB, -0.2 dB
AUX & Tape	10 Hz to 100,000 Hz +0 dB, -1.8 dB
Tone Control	
Bass	±7.5 dB at 100 Hz
Treble	±7.5 dB at 10,000 Hz
Loudness Control (-30 dB)	(1) + 3 dB at 100 Hz. (2) + 6 dB at 100 Hz
Subsonic Filter	20 Hz, 6 dB/oct
High Filter	8 kHz, 6 dB/oct

GENERAL

Power Consumption	460 watts at full power
A.C. Outlet	Switched 2, Unswitched 1
Dimensions	W 16-15/16" (430 mm) H 5-7/8" (149 mm) D 14-15/16" (379 mm)
Weight (Net)	25.4 lbs. (11.5 kg)

* Measured pursuant to Federal Trade Commission's Trade Regulation rule in U.S.A. on Power Output Claims for Amplifier.

Note: Kenwood follows a policy of continuous advancements in development. For this reason specifications may be changed without notice.



PRINTED IN JAPAN B50-1620-00 (KUMSWL) (T)

N/746 D12345/847 6789ON/848 D12345/949 6789ON/950 D12345/051