

***Pioneer***

**STEREO AMPLIFIER**

**A-307R**

**A-209R**

**Operating Instructions**

Thank you for buying this PIONEER product. Please read through these operating instructions so you will know how to operate your model properly. After you have finished reading the instructions, put them away in a safe place for future reference.

In some countries or regions, the shape of the power plug and power outlet may sometimes differ from that shown in the explanatory drawings. However, the method of connecting and operating the unit is the same.

**WARNING: TO PREVENT FIRE OR SHOCK HAZARD, DO NOT EXPOSE THIS APPLIANCE TO RAIN OR MOISTURE.**

*This product complies with the Low Voltage Directive (73/23/EEC), EMC Directives (89/336/EEC, 92/31/EEC) and CE Marking Directive (93/68/EEC).*

## IMPORTANT



The lightning flash with arrowhead symbol, within an equilateral triangle, is intended to alert the user to the presence of uninsulated "dangerous voltage" within the product's enclosure that may be of sufficient magnitude to constitute a risk of electric shock to persons.

### CAUTION

**RISK OF ELECTRIC SHOCK  
DO NOT OPEN**

#### CAUTION:

**TO PREVENT THE RISK OF ELECTRIC SHOCK, DO NOT REMOVE COVER (OR BACK). NO USER-SERVICEABLE PARTS INSIDE. REFER SERVICING TO QUALIFIED SERVICE PERSONNEL.**



The exclamation point within an equilateral triangle is intended to alert the user to the presence of important operating and maintenance (servicing) instructions in the literature accompanying the appliance.

## IMPORTANT

### FOR USE IN THE UNITED KINGDOM

**The wires in this mains lead are coloured in accordance with the following code :**

**Blue : Neutral  
Brown : Live**

If the plug provided is unsuitable for your socket outlets, the plug must be cut off and a suitable plug fitted.

The cut-off plug should be disposed of and must not be inserted into any 13 amp socket as this can result in electric shock. The plug or adapter or the distribution panel should be provided with a 5 amp fuse. As the colours of the wires in the mains lead of this appliance may not correspond with the coloured markings identifying the terminals in your plug, proceed as follows :

The wire which is coloured blue must be connected to the terminal which is marked with the letter N or coloured black. The wire which is coloured brown must be connected to the terminal which is marked with the letter L or coloured red.

Do not connect either wire to the earth terminal of a three-pin plug.

#### NOTE

After replacing or changing a fuse, the fuse cover in the plug must be replaced with a fuse cover which corresponds to the colour of the insert in the base of the plug or the word that is embossed on the base of the plug, and the appliance must not be used without a fuse cover. If lost, replacement fuse covers can be obtained from your dealer.

Only 5 A fuses approved by B.S.I. or A.S.T.A to B.S. 1362 should be used.

## POWER-CORD CAUTION

Handle the power cord by the plug. Do not pull out the plug by tugging the cord and never touch the power cord when your hands are wet as this could cause a short circuit or electric shock. Do not place the unit, a piece of furniture, etc., on the power cord, or pinch the cord. Never make a knot in the cord or tie it with other cords. The power cords should be routed such that they are not likely to be stepped on. A damaged power cord can cause fire or give you an electrical shock. Check the power cord once in a while. When you find it damaged, ask your nearest PIONEER authorized service center or your dealer for a replacement.

## MAINTENANCE OF EXTERNAL SURFACES

- Use a polishing cloth or dry cloth to wipe off dust and dirt.
- When the surfaces are dirty, wipe with a soft cloth dipped in some neutral cleanser diluted five or six times with water, and wrung out well, and then wipe again with a dry cloth. Do not use furniture wax or cleaners.
- Never use thinners, benzine, insecticide sprays or other chemicals on or near this unit, since these will corrode the surfaces.

# CONTENTS

FEATURES .....	3	OPERATIONS .....	9
INSTALLATION .....	3	REMOTE CONTROL .....	10
CONNECTIONS .....	4	TROUBLESHOOTING .....	11
PANEL FACILITIES .....	6	SPECIFICATIONS .....	12

# FEATURES

## ■ Direct Energy MOS Power Amp(on the A-307R)

Pioneer introduces amp circuitry featuring Direct Energy MOS FET devices for high performance. Together with Pioneer's original Wide Range Linear Circuit technology, this helps achieve reducing power consumption, while maintaining the power of current models.

In terms of performance, it contributes to flat damping factor characteristics across the audio spectrum, and improved power linearity.

## ■ Advanced Direct Energy MOS Power Amp(on the A-209R)

Pioneer incorporates highest quality amp circuitry featuring Advanced Direct Energy MOS FET devices which can achieve higher performance. Together with Pioneer's original Wide Range Linear Circuit technology they reduce power consumption while maintaining the power output of current models.

In terms of performance, this technology contributes to flat damping factor characteristics across the audio spectrum. It also allows a wide range and especially ultra high frequencies to be reproduced more accurately and improves power linearity.

## ■ Stabilizer (on the A-209R only)

Transformer stabilizer and stabilizer frame (attached to chassis) deliver powerful sound.

## ■ Low power consumption design

### ■ High-power Output:

**A-307R** ..... **80 W + 80 W/4 Ω (DIN)**

**55 W + 55 W/8 Ω (DIN)**

**A-209R** ..... **60 W + 60 W/4 Ω (DIN)**

**45 W + 45 W/8 Ω (DIN)**

## ■ Wide-Range Linear Circuit

This new current feedback circuit assures improved operating stability for flat output impedance and stable driving of speakers across the full range of frequencies.

## ■ Silent microprocessor system

# INSTALLATION

## LOCATION

### Install the unit in a well ventilated location where it will not be exposed to high temperature or humidity.

Do not install the unit in a location which is exposed to direct rays of the sun, or near hot appliances or radiators. Excessive heat can adversely affect the cabinet and internal components. Installation of the unit in a damp or dusty environment may also result in a malfunction or an accident. (Avoid installation near cookers etc., where the unit may be exposed to oily smoke, steam or heat.)

Do not install the unit on a tottered stand, nor on an unstable or inclined surface.

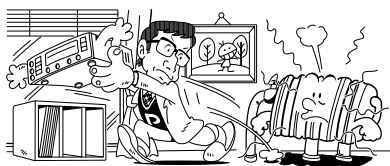

## VENTILATION

- When installing this unit, make sure to leave space around the unit for ventilation to improve heat radiation (at least 60 cm at top, 10 cm at rear, and 30 cm at each side). If not enough space is provided between the unit and walls or other equipment, heat will build up inside, interfering with performance or causing malfunctions.
- Do not place on a thick carpet, bed, sofa or fabric having a thick pile. Do not cover with fabric or other covering. Anything that blocks ventilation will cause internal temperature to rise, which may lead to breakdown or fire hazard.

# CONNECTIONS

Before making or changing the connections, switch off the power switch.

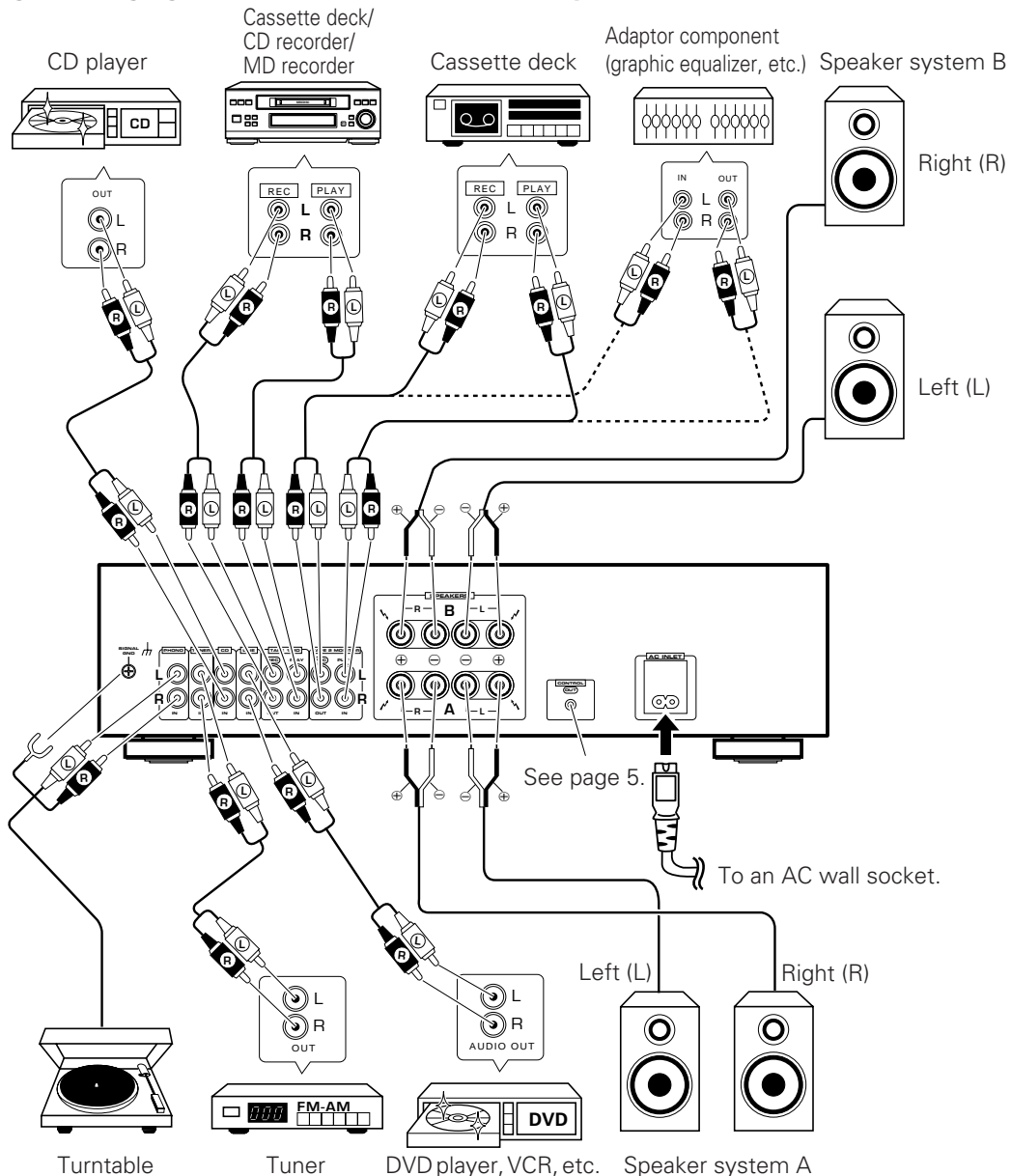

## CONNECTING THE SPEAKER CORDS

1. Strip off the vinyl covering and twist the tip of the wire core.



2. Loosen the knob and insert the wire core into the terminal hole.
3. Tighten the knob to fix the wire core in place.

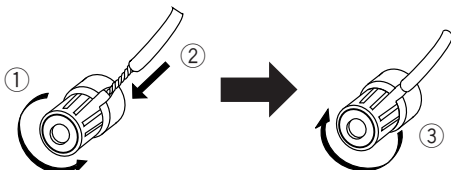

### NOTE:

Do not allow any of the cord conductors to protrude from the terminals or touch any other conductors. Malfunctioning or breakdowns may occur when conductors come into contact with each other.

### Speaker Impedance

When speaker systems are connected to only SPEAKERS A or SPEAKERS B terminals, such speakers should have rated impedance in the range of 4–16  $\Omega$ .

When speaker are connected to both A and B terminals, they should have a rated impedance in the range of 8–32  $\Omega$ .

### CONNECTING THE INPUT/OUTPUT CORDS

Connect the white plug to the L (left) channel, and the red plug to the R (right) channel. Be sure to push the plugs securely.

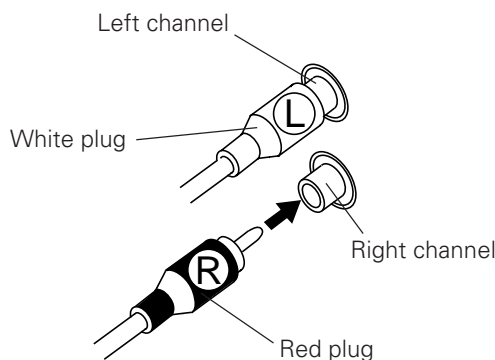

### REMOTE CONTROL CORD CONNECTIONS

By interconnecting the CONTROL jacks of Pioneer units with the  mark, the entire system can be operated with this remote control unit, although some of the units (AM/FM tuner, CD player, cassette deck, etc.) may not be equipped with remote sensors. The entire system can be operated by a remote control unit by connecting PIONEER stereo components to each other using the control input (CONTROL IN) jack on each component. Use the remote control cord supplied with the respective unit for the connection. An example is shown in the figure. As long as you connect "OUT" to "IN", the connecting sequence is arbitrary. When a unit has only an "IN" connector, however, connect it last.

**NOTE:**

When the POWER switch is set to OFF, the components connected to the CONTROL OUT jack can not be operated with the remote control unit.

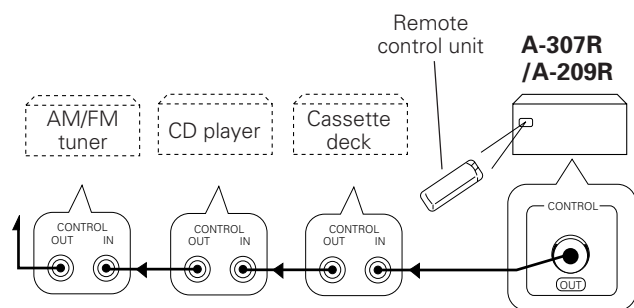

### LOADING BATTERIES

Open the battery compartment cover on the back of the remote control unit. Insert size AA/R6P dry cell batteries into the battery compartment in accordance with the indications (+, -) inside the compartment. Close the cover of the battery case.

**Incorrect use of batteries may lead to leakage or rupture. Always be sure to follow these guidelines:**

1. Always insert batteries into the battery compartment correctly matching the positive (+) and the negative (-) polarities as indicated inside the compartment.
2. Never mix new and used batteries.
3. Batteries of the same size may have different voltages depending on their type. Do not mix different types of batteries.

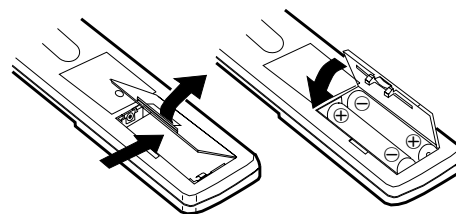

### RANGE OF REMOTE CONTROL

When the remote control unit is pointed at the remote sensor window on the stereo amplifier and any of its buttons is pressed, the unit and other components can be operated by remote control.

**Distance** : Within a range of approx. 7 meters from the unit's remote control sensor window.

**Angle** : Within approx. 30 degrees from the center of the unit's remote control sensor window. Remote control will not be possible if there is an obstacle between the remote control unit itself and the unit's remote control sensor window.

- The accessory remote control unit can be used to control some functions of other Pioneer cassette decks, CD players and tuners (only those Pioneer components bearing the  mark).

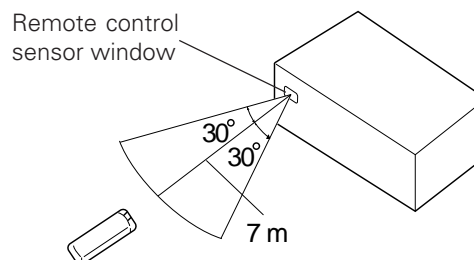

# PANEL FACILITIES

## [ FRONT PANEL ]

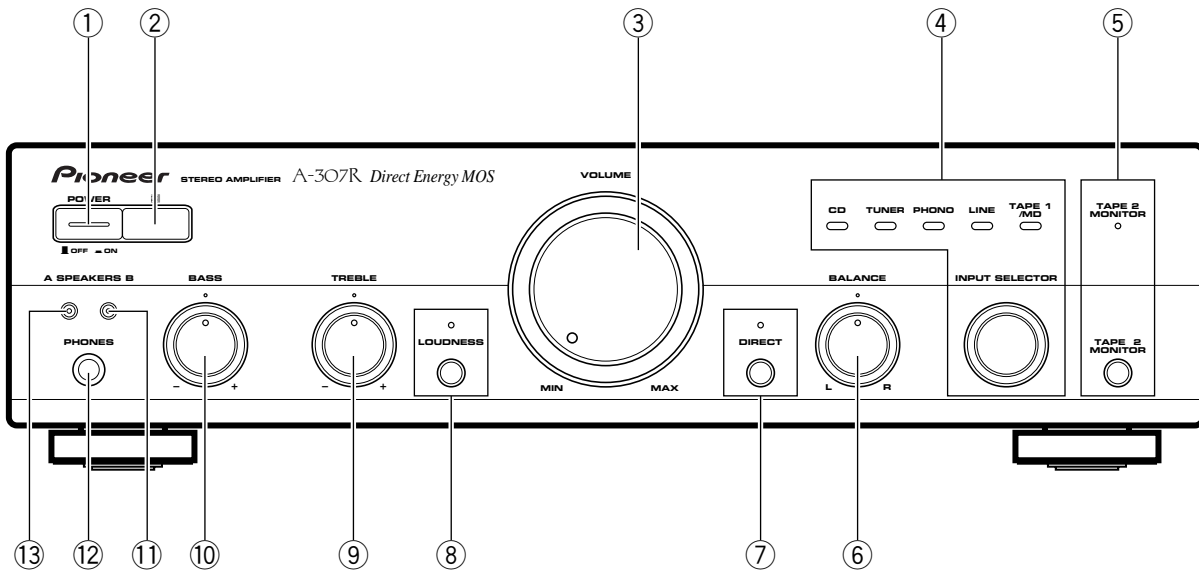

The illustration shows the A-307R.

### ① POWER (■ OFF/■ ON) switch

Press to turn power to the unit ON and OFF. This unit cannot be turned ON and OFF using the remote control unit.

### ② REMOTE CONTROL SENSOR window

### ③ VOLUME control

Use to adjust the volume level.

### ④ INPUT SELECTOR knob/indicators

Turn the knob clockwise or counterclockwise so that the indicator lights for your desired input source. Turning the knob clockwise causes the lit indicator to right. Turning counterclockwise causes it to left.

- CD** : For compact disc playback with a CD player.
- TUNER** : For AM or FM broadcast reception with a tuner.
- PHONO** : For record playback with a turntable.
- LINE** : Set to this position when listening to the program from a component connected to the LINE terminals.
- TAPE 1/MD** : For playback with a cassette deck or MD recorder connected to TAPE1/MD terminals (on the A-307R only).
- TAPE 1/CD-R/MD**: For playback with a cassette deck, CD recorder or MD recorder connected to TAPE1/CD-R/MD terminals (on the A-209R only).

### ⑤ TAPE 2 MONITOR button/indicator

Use when there is an adaptor component (graphic equalizer, etc.) or cassette deck connected to the TAPE2 MONITOR terminals.

- On** : Indicator lights when using the adaptor component or listening to the cassette deck.
- Off** : Indicator goes off when not in use.

### NOTES:

- When no connections are made to the TAPE2 MONITOR terminals, or when they are not in use, be sure to set this switch to the off position. (No sound will be heard if it is set to the on position.)
- When the TAPE2 MONITOR indicator is on and the INPUT SELECTOR knob is not set to TAPE1/MD (on the A-307R) or TAPE1/CD-R/MD (on the A-209R), the signals which are input through TAPE 2 MONITOR are then output at TAPE1/MD (on the A-307R) or TAPE1/CD-R/MD (on the A-209R) REC OUT.

### ⑥ BALANCE control

Should normally be left in the center position. Adjust balance if the sound is louder from one of the speakers. If the right side is louder, turn toward the L (left) position and if the left side is louder, turn toward the R (right) position.

### NOTE:

This control does not operate when the DIRECT button is in the on position.

⑦ **DIRECT button/indicator**

Use this button when you do not wish to pass the output from input terminal equipment through the various frequency adjusting circuits (BASS, TREBLE, BALANCE, LOUDNESS).

**On** : The indicator lights: The signals passing through the input terminals are reproduced without passing through the various frequency adjusting circuits. This results in flat, pure sound which is a more faithful reproduction of the input source.

**Off** : The indicator goes off: The signal passes through the various frequency adjusting circuits.

⑧ **LOUDNESS button/indicator**

Use when listening at low volume levels.

**On** : The indicator lights: Boosts low and high frequencies to give added punch to playback even at a low volume level.

**Off** : The indicator goes off: Should normally be left in this position.

**NOTE:**

*This button does not operate when the DIRECT button is in the on position.*

⑨ **TREBLE tone control**

Use to adjust the high-frequency tone. The center position is the flat (normal) position. When turned to the right, high-frequency tones are emphasized; when turned to the left, high-frequency tones are de-emphasized.

**NOTE:**

*This control does not operate when the DIRECT button is in the on position.*

⑩ **BASS tone control**

Use to adjust the low-frequency tone. The center position is the flat (normal) position. When turned to the right, low-frequency tones are emphasized; when turned to the left, low-frequency tones are de-emphasized.

**NOTE:**

*This control does not operate when the DIRECT button is in the on position.*

⑪ **SPEAKERS B (ON/OFF) button/indicator**

Use this button to listen to the speaker system connected to SPEAKERS B terminals.

**ON** : The indicator lights. Sound is heard from the speaker system.

**OFF** : The indicator goes off. No sound is heard from the speaker system. Set to this position when listening with headphones.

⑫ **PHONES jack**

When using headphones, insert the plug into this jack.

**NOTE:**

*The speakers continue to output sound even when headphones are plugged into this jack.*

*To mute the sound from the speakers, press the SPEAKERS button to OFF.*

⑬ **SPEAKERS A (ON/OFF) button/indicator**

Use this button to listen to the speaker system connected to SPEAKERS A terminals.

**ON** : The indicator lights. Sound is heard from the speaker system.

**OFF** : The indicator goes off. No sound is heard from the speaker system. Set to this position when listening with headphones.

## PANEL FACILITIES

### [ REAR PANEL ]

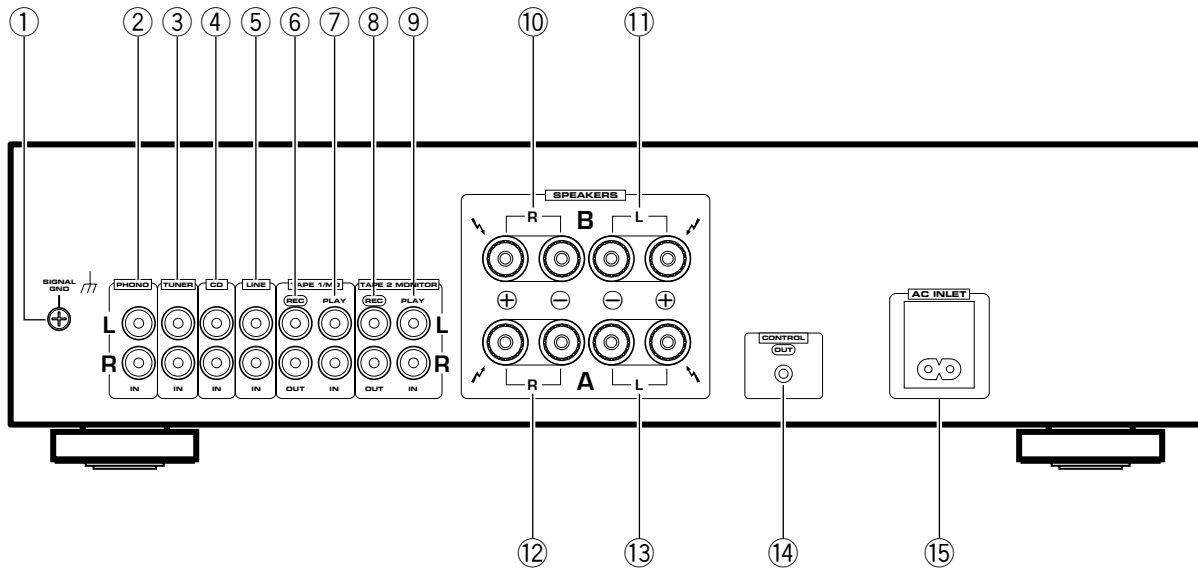

The illustration shows the A-307R.

- ① **GND (Turntable ground) terminal**
- ② **PHONO terminals**
- ③ **TUNER terminals**
- ④ **CD terminals**
- ⑤ **LINE terminals**
- ⑥ **TAPE 1/MD REC (OUT) terminals** (on the A-307R only)  
**TAPE 1/CD-R/MD REC (OUT) terminals** (on the A-209R only)
- ⑦ **TAPE 1/MD PLAY (IN) terminals** (on the A-307R only)  
**TAPE 1/CD-R/MD PLAY (IN) terminals** (on the A-209R only)
- ⑧ **TAPE 2 MONITOR REC (OUT) terminals**
- ⑨ **TAPE 2 MONITOR PLAY (IN) terminals**
- ⑩ **SPEAKERS B terminals (Right channel)**
- ⑪ **SPEAKERS B terminals (Left channel)**
- ⑫ **SPEAKERS A terminals (Right channel)**
- ⑬ **SPEAKERS A terminals (Left channel)**
- ⑭ **CONTROL OUT jack (see page 5)**  
This jack is for output of control signals when operating other components bearing the  mark with the attached remote control unit.
- ⑮ **AC INLET jack**  
Connect power cord to here and an AC wall socket, or the AC outlet of an audio timer.  
If you are going to be away from home for a long period of time, disconnect the unit from the wall socket.

#### NOTES:

- If you use an other power cord than provided, we cannot assume the liabilities in what may occur as a result of it.
- (The provided power cord has a current capacity of 2.5 A.)



# OPERATIONS

## BEFORE BEGINNING OPERATIONS

1. Set the **VOLUME** control to minimum.
2. Set the **POWER** switch to **ON**.
3. Press the **SPEAKERS** button corresponding to the speaker system to be used.
4. Set the **BALANCE** control to the center position.
5. Set the **DIRECT** button to off.
6. Set the **TAPE2 MONITOR** button to off.

## PLAYBACK PROCEDURES

1. Set the **INPUT SELECTOR** knob to the desired playback source.
  - For playback of a compact disc: Set to [CD].
  - For reception of an AM/FM broadcast: Set to [TUNER].
  - For playback of a record: Set to [PHONO].
  - For playback with the equipment connected to LINE terminals: Set to [LINE].
  - For playback of a tape: Set to [TAPE1/MD](on the A-307R), [TAPE1/CD-R/MD](on the A-209R).

### NOTES:

- When you do not want to monitor the **TAPE2 MONITOR** sound, set the **TAPE2 MONITOR** button to **OFF**.
  - When you select **PHONO**, the sound is muted for a few seconds.
2. Operate the equipment to begin playback.
  3. Adjust playback volume with **VOLUME** control on this unit.
  4. Adjust the tone to your preference using the **BASS** and **TREBLE** controls, and **LOUDNESS** button.

## RECORDING TAPES

1. Select the recording equipment with the **INPUT SELECTOR** knob.
2. Begin recording by operating the recording equipment and cassette deck.

Refer to the operating instructions of your cassette deck for proper operating procedures.

## COPYING TAPES

When two decks are used, you can record the sounds from one deck onto the other.

### Application examples:

- To make a tape copy with contents identical to the original tape.
- To edit a recording of an FM broadcast in order to cut out unwanted commercials, recording only of desired material onto another tape.

1. Load tapes for playback (pre-recorded tape) and recording (blank tape) into the respective cassette decks.
2. Select the copying direction with the **INPUT SELECTOR** knob and **TAPE2 MONITOR** button.
  - When copying from the cassette deck of **TAPE1/MD**(on the A-307R) or **TAPE1/CD-R/MD**(on the A-209R) terminals to the cassette deck of the **TAPE2 MONITOR** terminals: Set the **INPUT SELECTOR** knob to **TAPE1/MD**(on the A-307R), **TAPE1/CD-R/MD**(on the A-209R).
  - When copying from the cassette deck of **TAPE2 MONITOR** terminals to the cassette deck of **TAPE1/MD**(on the A-307R), **TAPE1/CD-R/MD**(on the A-209R) terminals: Set the **TAPE2 MONITOR** button to **ON** and the **INPUT SELECTOR** knob to a position other than **TAPE1/MD**(on the A-307R), **TAPE1/CD-R/MD**(on the A-209R).
3. Operate the cassette decks to begin copying.

Set the cassette deck with the original (playback) tape to the playback mode, and set the cassette deck with the blank tape to the recording mode.

## TO USE THE COMPONENT CONNECTED TO THE TAPE2 MONITOR TERMINALS

### [For a cassette deck]

- A cassette deck connected here can be operated in the same way (recording and playback) as a deck connected to the **TAPE2 MONITOR** terminals.
- Also, if two decks are used, you can copy tapes from one deck onto the other (see the section "COPYING TAPES").

1. Set the **TAPE2 MONITOR** button to **ON**.
2. Operate the cassette deck to perform playback (or recording).

### NOTE:

The source selected with the **INPUT SELECTOR** knob is backed up for a few days even when the **POWER** switch is set to off or the power cord is unplugged.

After this period, the **CD** is automatically selected when the power is supplied.

### [For an adaptor component]

By connecting a graphic equalizer, source sounds (from discs, tapes, AM/FM broadcasts, etc.) can be heard with added sound and tone compensation.

Sounds compensated with the adaptor component can be recorded on the cassette deck connected to the **TAPE1/MD**(on the A-307R) or **TAPE1/CD-R/MD**(on the A-209R) terminals.

1. Set the **TAPE2 MONITOR** button to **ON**.
2. Play back the source.
3. Operate the adaptor component.

### NOTE:

Be sure to perform this operation with the adaptor component power switch in the on position. Even when not using the adaptor component, its power switch must be left on. If the adaptor component is switched off, no sound will be produced, or the playback sound will be distorted.

# REMOTE CONTROL

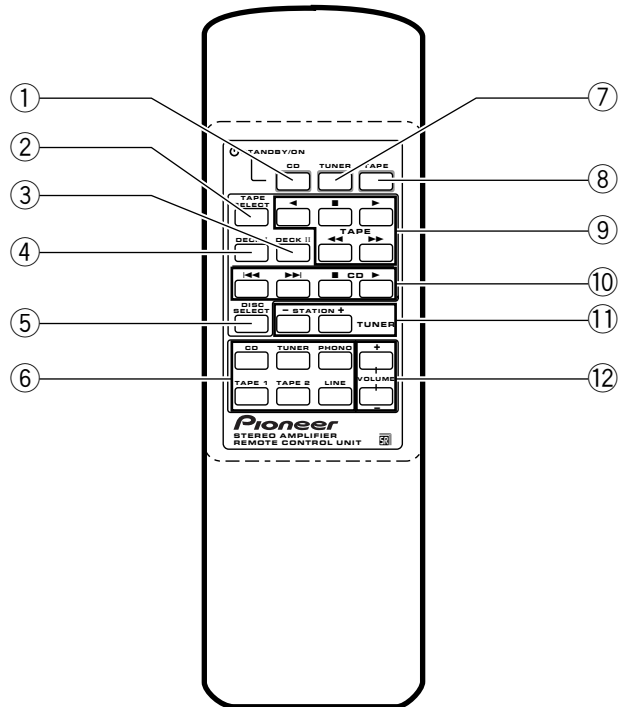

① **CD POWER button**

Switches CD player power ON/OFF.

② **TAPE SELECT button**

Selects the cassette No. (1 to 6) for multi-cassette changer.

③ **DECK II button**

To operate Deck II, press this button before pressing the operating buttons. Also, when using a single deck, press this button before pressing the operating buttons.

④ **DECK I button**

To operate Deck I, press this button before pressing the operating buttons.

⑤ **DISC SELECT button**

Press this to select discs on a multi or twin tray compact disc player.

⑥ **Input selector button**

Use to select the playback source.

**CD** : For compact disc playback with a CD player.

**TUNER** : For AM or FM broadcast reception with a tuner.

**PHONO** : For record playback with a turntable.

**TAPE 1** : For playback with a cassette deck, CD recorder or MD recorder connected to TAPE1/MD (on the A-307R) or TAPE1/CD-R/MD (on the A-209R) terminals.

**TAPE 2** : For playback with a cassette deck or adaptor connected to TAPE 2 MONITOR terminals.

**LINE** : For playback with a component connected to the LINE terminal.

⑦ **TUNER POWER button**

Switches TUNER power ON/OFF.

⑧ **TAPE POWER button**

Switches the cassette deck power ON/OFF. (Can not turn ON/OFF some cassette decks.)

⑨ **TAPE operation buttons**

◀, ▶ : Playback in the direction of the arrows.

■ : Stop

◀◀, ▶▶ : Tape fast forward/reverse.

⑩ **CD player operation buttons**

◀◀ : Returns you to the start of the current track. (Track search)

▶▶ : Takes you to the start of the next track. (Track search)

■ : Stop

▶ : Play

⑪ **STATION + (up), - (down) buttons**

Calls each station number in sequence.

⑫ **VOLUME + (up), - (down) buttons**

+ ..... Increases the volume.

- ..... Decreases the volume.

**NOTE:**

When the accessory remote control unit is used to operate other Pioneer components with the  mark, it cannot be used to operate functions which do not correspond to the functions listed on the remote control unit.

# TROUBLESHOOTING

Incorrect operations are often mistaken for trouble and malfunctions. If you think that there is something wrong with this component, check the points below. Sometimes the trouble may lie in another component. Investigate the other components and electrical appliances being used.

If the trouble cannot be rectified even after exercising the checks listed below, ask your nearest PIONEER authorized service center or your dealer to carry out repair work.

Symptom	Cause	Remedy
<b>No power supplied to unit.</b>	<ul style="list-style-type: none"> <li>● Power plug is disconnected from outlet.</li> <li>● The amplifier's power plug has been plugged into another component power outlet (e.g. timer, etc.) but power to that unit is disconnected.</li> <li>● The AC INLET plug is disconnected.</li> </ul>	<ul style="list-style-type: none"> <li>● Insert plug securely into outlet.</li> <li>● Turn on power to other component.</li> <li>● Insert the AC INLET plug securely till the bottom of the jack.</li> </ul>
<b>No sound.</b>	<ul style="list-style-type: none"> <li>● Connecting cords are disconnected from terminals, or connected incorrectly.</li> <li>● Terminals, or connecting cords pin plugs are dirty.</li> <li>● The TAPE2 MONITOR button is set to ON (except when using an adaptor component).</li> <li>● Operation of other components is incorrect.</li> <li>● The position of the INPUT SELECTOR does not match the component to be played back.</li> <li>● Both SPEAKERS selector buttons are set to OFF.</li> </ul>	<ul style="list-style-type: none"> <li>● Connect securely.</li> <li>● Clean terminals and plugs.</li> <li>● Set the TAPE2 MONITOR button to OFF.</li> <li>● Consult the operating instructions for the other components.</li> <li>● Set the button correctly (CD, TUNER, PHONO, LINE, TAPE1/MD (on the A-307R), TAPE1/CD-R/MD (on the A-209R)).</li> <li>● Set one button or both buttons to ON.</li> </ul>
<b>No sound from one speaker.</b>	<ul style="list-style-type: none"> <li>● Connecting cords or speaker cords are disconnected on that side.</li> <li>● BALANCE control is set to one side.</li> </ul>	<ul style="list-style-type: none"> <li>● Connect securely.</li> <li>● Set BALANCE control to center position.</li> </ul>
<b>Cannot record tapes.</b>	<ul style="list-style-type: none"> <li>● Connections are incorrect.</li> <li>● Operation of cassette deck is incorrect.</li> <li>● The TAPE2 MONITOR button is set to ON.</li> </ul>	<ul style="list-style-type: none"> <li>● Reconnect properly.</li> <li>● Consult the operating instructions for the cassette deck.</li> <li>● Set the TAPE2 MONITOR button to OFF.</li> </ul>
<b>Cannot perform tape copying.</b>	<ul style="list-style-type: none"> <li>● The position of the INPUT SELECTOR knob and TAPE2 MONITOR button are incorrect (when using 2 cassette decks).</li> <li>● Operation of cassette decks is incorrect.</li> </ul>	<ul style="list-style-type: none"> <li>● Set buttons correctly (See section COPYING TAPES).</li> <li>● Consult the operating instructions for the cassette decks.</li> </ul>
<b>The remote control unit does not work. (Other components cannot be operated.)</b>	<ul style="list-style-type: none"> <li>● Batteries are dead or no batteries in remote control unit.</li> <li>● The remote control sensor is not receiving any signals.</li> <li>● The remote control cord is not connected correctly.</li> <li>● A fluorescent light is shining on the remote sensor window.</li> </ul>	<ul style="list-style-type: none"> <li>● Insert new batteries (see page 5).</li> <li>● Operate the remote control unit within a range of 7 meters and an angle of 30 degrees (refer to page 5).</li> <li>● Connect correctly (see page 5).</li> <li>● Move so fluorescent light does not shine directly on amplifier's front panel remote sensor window.</li> </ul>

- Abnormal functioning of this unit may be caused by static electricity, or other external interference. To restore normal operation, turn the power off and then on again, or unplug the AC power cord and then plug it in again.

# SPECIFICATIONS

## Amplifier Section

Continuous power output  
(both channels driven at 20 Hz to 20 kHz)\*\*

[A-307R]  
T.H.D. 0.1 %, 8 Ω ..... 45 W + 45 W\*  
T.H.D. 0.15 %, 4 Ω ..... 65 W + 65 W\*

[A-209R]  
T.H.D. 0.1 %, 8 Ω ..... 35 W + 35 W\*  
T.H.D. 0.15 %, 4 Ω ..... 45 W + 45 W\*

DIN Continuous power output  
(both channels driven at 1 kHz)

[A-307R]  
T.H.D. 1.0 %, 8 Ω ..... 55 W + 55 W  
T.H.D. 1.0 %, 4 Ω ..... 80 W + 80 W

[A-209R]  
T.H.D. 1.0 %, 8 Ω ..... 45 W + 45 W  
T.H.D. 1.0 %, 4 Ω ..... 60 W + 60 W

Total harmonic distortion\*\*

[A-307R]  
20 Hz to 20 kHz, 22.5 W, 8 Ω ..... 0.08 %\*

[A-209R]  
20 Hz to 20 kHz, 17.5 W, 8 Ω ..... 0.08 %\*

● Power output specification is for when power supply is 230 V.

Input sensitivity/impedance

PHONO (MM) ..... 2.8 mV/50 kΩ

[A-307R]  
CD, TUNER, LINE, TAPE1/MD, TAPE2 MONITOR  
..... 200 mV/50 kΩ

[A-209R]  
CD, TUNER, LINE, TAPE1/CD-R/MD, TAPE2 MONITOR  
..... 200 mV/50 kΩ

PHONO (MM) overload level  
1 kHz, T.H.D. 0.1 % ..... 150 mV

Output level/impedance  
TAPE1 REC, TAPE2 MONITOR REC ..... 200 mV/1 kΩ

Frequency response

PHONO (MM) ..... 20 Hz to 20 kHz, ±0.5 dB

[A-307R]  
CD, TUNER, LINE, TAPE1/MD, TAPE2 MONITOR  
..... 5 Hz to 100 kHz,  $^{+0}_{-3}$  dB\*

[A-209R]  
CD, TUNER, LINE, TAPE1/CD-R/MD, TAPE2 MONITOR  
..... 5 Hz to 100 kHz,  $^{+0}_{-3}$  dB\*

Tone control

BASS ..... ±8 dB (100 Hz)  
TREBLE ..... ±8 dB (10 kHz)

Loudness contour (volume control set at -30 dB position)  
..... +6 dB (100 Hz)/+4 dB (10 kHz)

Signal-to-Noise ratio (IHF short circuit, A network)

PHONO (MM, 5 mV input) ..... 85 dB\*

[A-307R]  
CD, TUNER, LINE, TAPE1/MD, TAPE2 MONITOR  
..... 106 dB\*

[A-209R]  
CD, TUNER, LINE, TAPE1/CD-R/MD, TAPE2 MONITOR  
..... 106 dB\*

Signal-to-Noise ratio (DIN, continuous power/50 mW)

PHONO (MM) ..... 71 dB/67 dB\*

[A-307R]  
CD, TUNER, LINE, TAPE1/MD, TAPE2 MONITOR  
..... 91 dB/71 dB\*

[A-209R]  
CD, TUNER, LINE, TAPE1/CD-R/MD, TAPE2 MONITOR  
..... 91 dB/71 dB\*

## Power Supply/Miscellaneous

Power requirements ..... AC 220 – 230 V, 50/60 Hz

Power consumption

[A-307R] ..... 140 W  
[A-209R] ..... 130 W

Dimensions (including knobs and other protruding parts)  
..... 420 (W) x 114 (H) x 307 (D) mm

Weight (without package)

[A-307R] ..... 5.9 kg  
[A-209R] ..... 4.7 kg

## Accessories

Remote control unit ..... 1  
Batteries (AA/R6P) ..... 2  
Power cord (Rated current 2.5 A) ..... 1  
Operating instructions ..... 1  
Warranty card ..... 1

### NOTE:

Specifications and design are subject to possible modifications without notice, due to improvements.

\* Measured with DIRECT button set to on.

\*\* Measured by Audio Spectrum Analyzer.

Published by Pioneer Corporation.  
Copyright © 2000 Pioneer Corporation.  
All rights reserved.

**PIONEER CORPORATION** 4-1, Meguro 1-Chome, Meguro-ku, Tokyo 153-8654, Japan  
**PIONEER ELECTRONICS [USA] INC.** P.O. BOX 1540, Long Beach, California 90801-1540, U.S.A.  
**PIONEER ELECTRONICS OF CANADA, INC.** 300 Allstate Parkway, Markham, Ontario L3R 0P2, Canada  
**PIONEER ELECTRONIC [EUROPE] N.V.** Haven 1087, Keetberglaan 1, 9120 Melsele, Belgium TEL: 03/570.05.11  
**PIONEER ELECTRONICS AUSTRALIA PTY. LTD.** 178-184 Boundary Road, Braeside, Victoria 3195, Australia, TEL: [03] 9586-6300  
**PIONEER ELECTRONICS DE MEXICO S.A. DE C.V.** San Lorenzo Num 1009 3er piso Desp. 302 Col. Del Valle, Mexico D.F. C.P. 03100 TEL: 5-688-52-90