

HiFi ENGINE®

For more Hi-Fi manuals and set-up information
please visit www.hifiengine.com

SERVICE MANUAL

PARTS LIST

MODEL AM-2350

AKAI

ALSO APPLICABLE TO BLACK PANEL MODEL

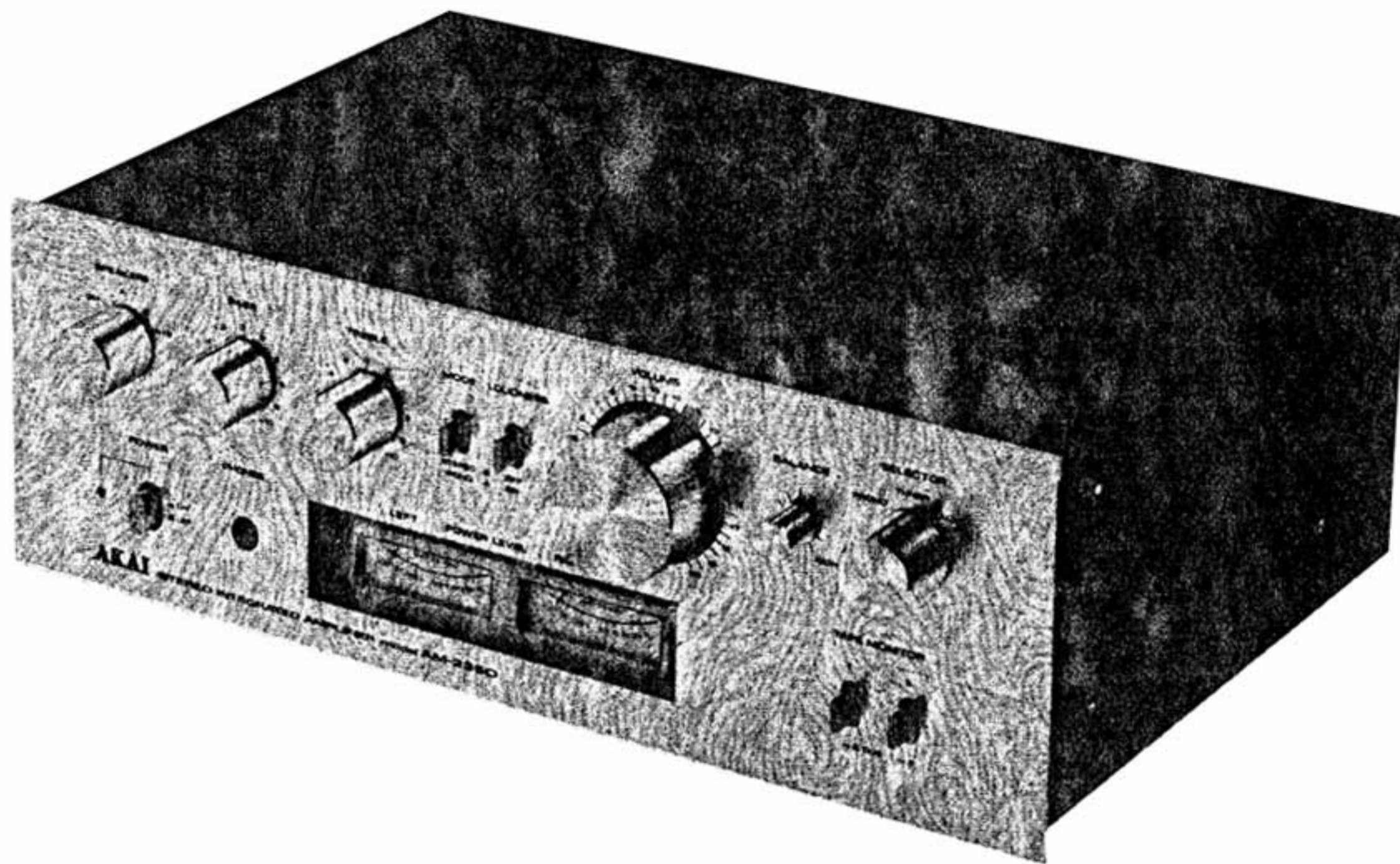

STEREO INTEGRATED AMPLIFIER

MODEL **AM-2350**

SECTION 1	SERVICE MANUAL	1
SECTION 2	PARTS LIST	11
SECTION 3	SCHEMATIC DIAGRAM.....	20

SECTION 1

SERVICE MANUAL

TABLE OF CONTENTS

I.	TECHNICAL DATA	2
	1. POWER AMPLIFIER SECTION	2
	2. PREAMPLIFIER SECTION	2
	3. GENERAL	2
II.	DISMANTLING OF UNIT	3
III.	CONTROLS	4
IV.	PRINCIPAL PARTS LOCATION	5
V.	BLOCK DIAGRAM AND LEVEL DIAGRAM	6
VI.	LEVEL METER INDICATION ADJUSTMENT	7
VII.	COMPOSITION OF VARIOUS P.C BOARDS	8

For basic adjustments, measuring methods, and operating principles, please refer to the "GENERAL TECHNICAL MANUAL".

I. TECHNICAL DATA

1. POWER AMPLIFIER SECTION

RATED OUTPUT POWER 2-CHANNEL DRIVEN	35 watts per channel, minimum RMS, at 8 ohms from 20 to 20,000 Hz with no more than 0.2% total harmonic distortion.
POWER BANDWIDTH (IHF)	10 Hz to 40 kHz at 8 ohms with total harmonic distortion of 0.2%.
SIGNAL-TO-NOISE RATIO (IHF) PHONO AUX	Better than 75 dB. Better than 95 dB.
RESIDUAL NOISE	Less than 0.6 mV at 8 ohms.
CHANNEL SEPARATION (IHF) PHONO AUX	Better than 50 dB at 1,000 Hz. Better than 55 dB at 1,000 Hz.
DAMPING FACTOR	More than 30 (1 kHz, 8 ohms).
OUTPUT SPEAKERS HEADPHONE	A, B (4 to 16 ohms)/A + B (8 to 16 ohms). 4 to 16 ohms.

2. PREAMPLIFIER SECTION

INPUT SENSITIVITY/IMPEDANCE PHONO AUX TUNER TAPE	3 mV/47 kohms. 150 mV/100 kohms. 150 mV/100 kohms. PIN: 150 mV/100 kohms. DIN: 150 mV/100 kohms.
OUTPUT LEVEL/IMPEDANCE TAPE REC	PIN: 150 mV/100 kohms. DIN: 30 mV/80 kohms.
FREQUENCY RESPONSE PHONO AUX	30 Hz to 15 kHz, +1 dB, -1 dB (RIAA). 10 Hz to 50 kHz, +1 dB, -1 dB.
TONE CONTROL BASS TREBLE	±10 dB at 100 Hz. ±10 dB at 10 kHz.
LOUDNESS CONTROL	+10 dB at 100 Hz, +5 dB at 10 kHz.

3. GENERAL

SEMICONDUCTORS	Transistors: 16, diodes: 13, ICs: 2.
POWER REQUIREMENTS	120 V, 60 Hz for USA and Canada. 220 V, 50 Hz for Europe except UK and Australia. 240 V, 50 Hz for UK and Australia. 110/120/220/240 V, 50/60 Hz switchable for other countries.
DIMENSIONS	380 (W) x 123 (H) x 241 (D) mm (15 x 4.8 x 9.5 inches).
WEIGHT	7 kg (15.4 lbs)

* For improvement purposes, specifications and design are subject to change without notice.

II. DISMANTLING OF UNIT

In case of trouble, etc. necessitating disassembly, please disassemble in the order shown in photographs. Reassemble in reverse order.

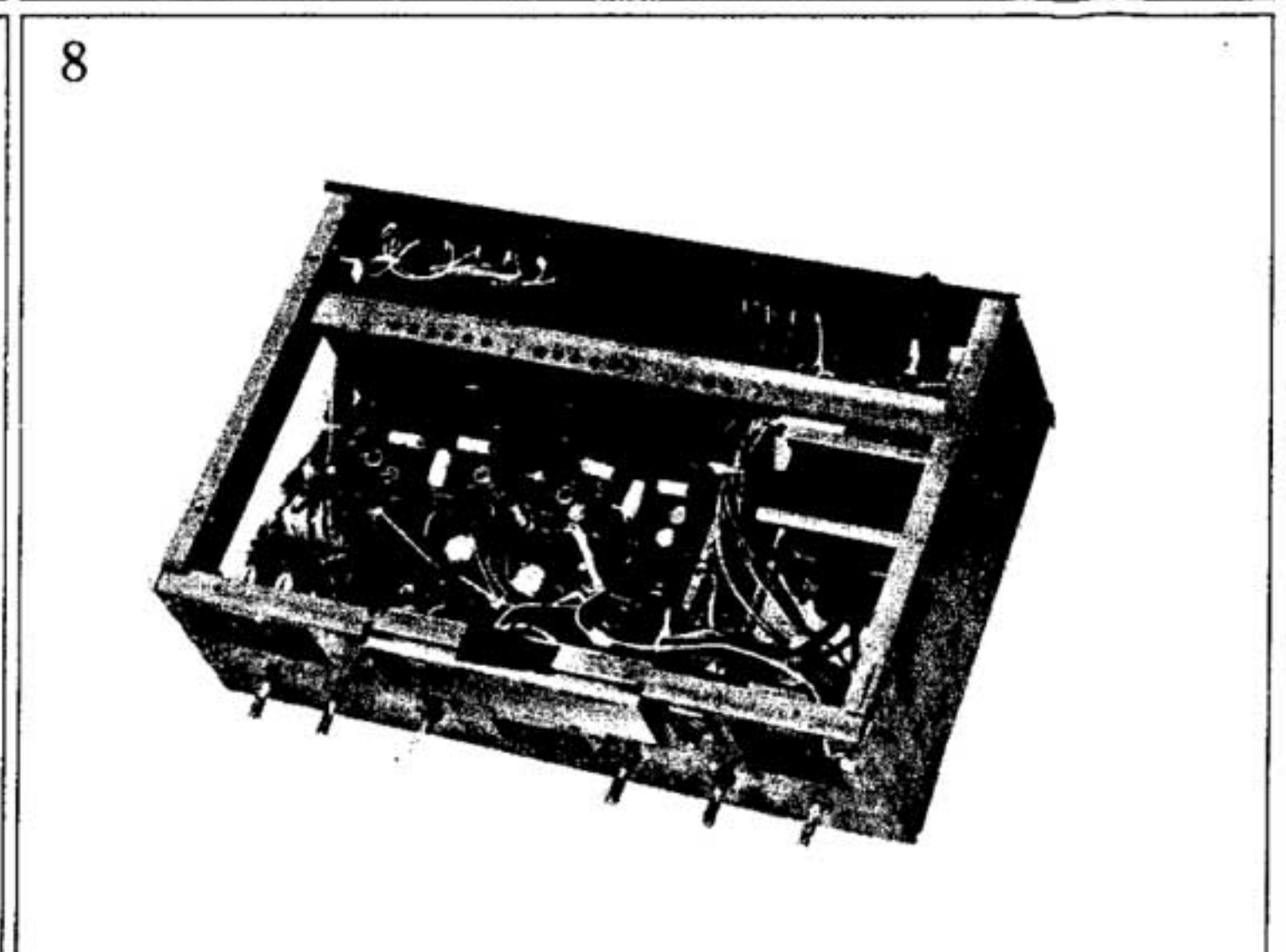
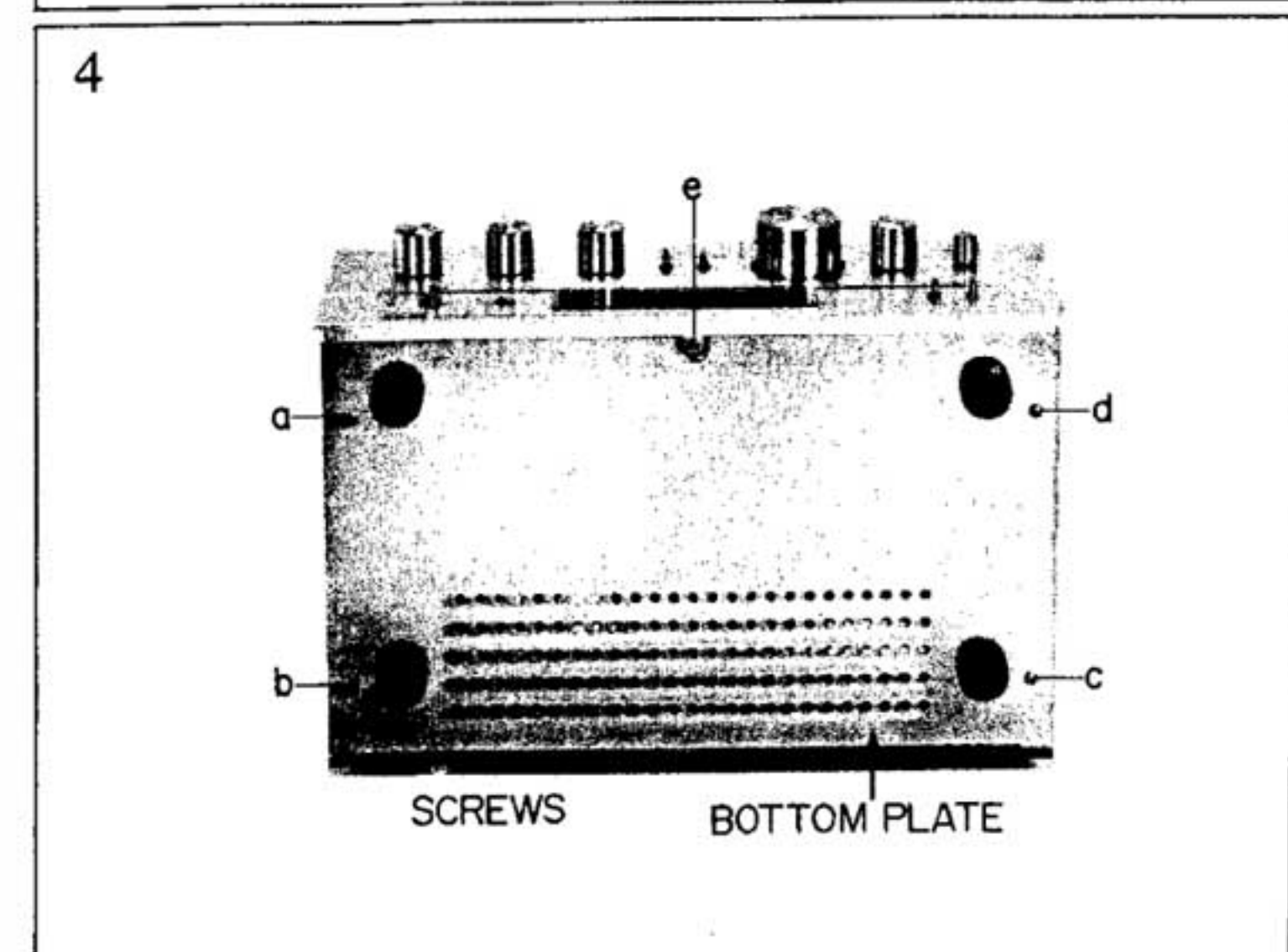
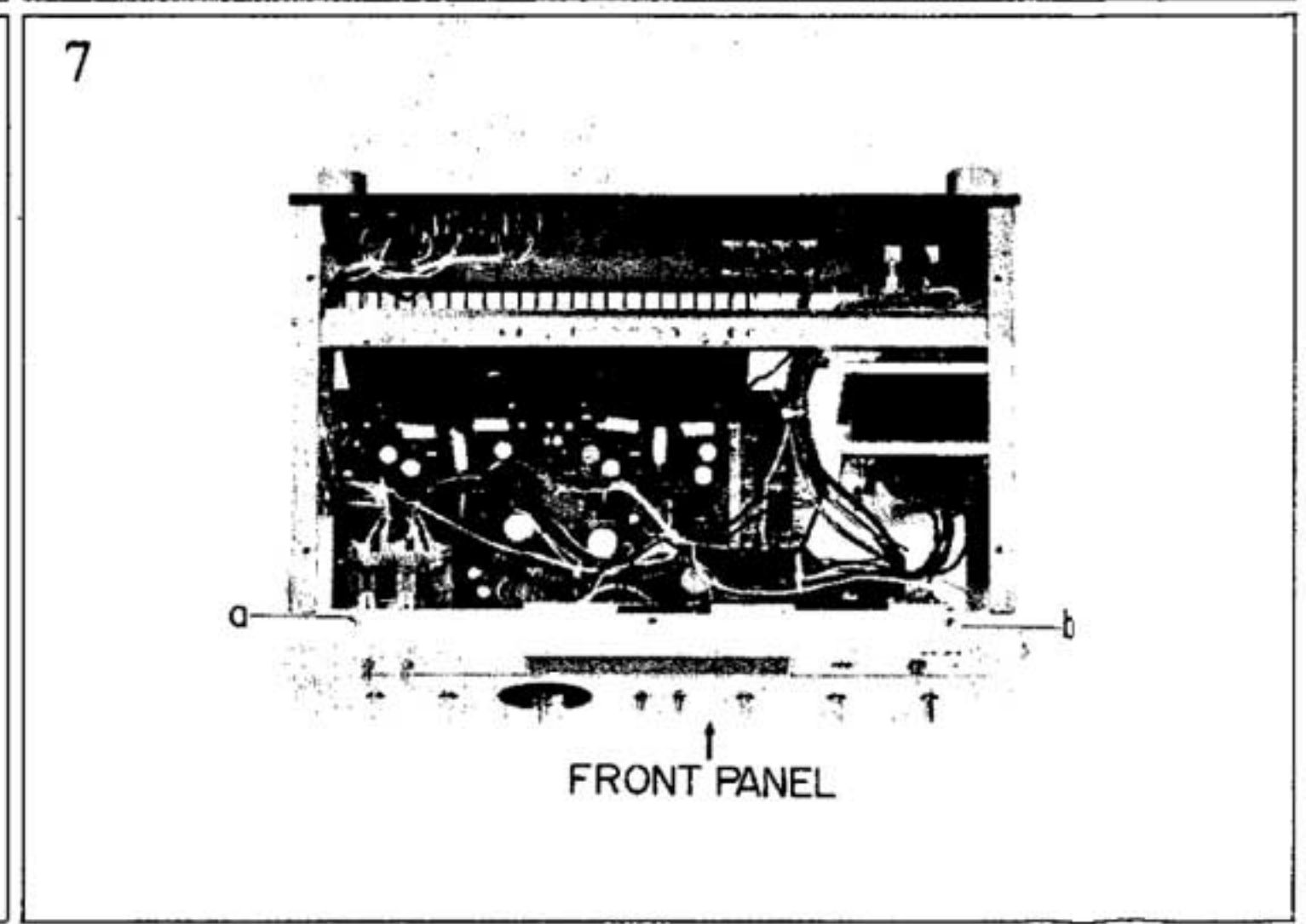
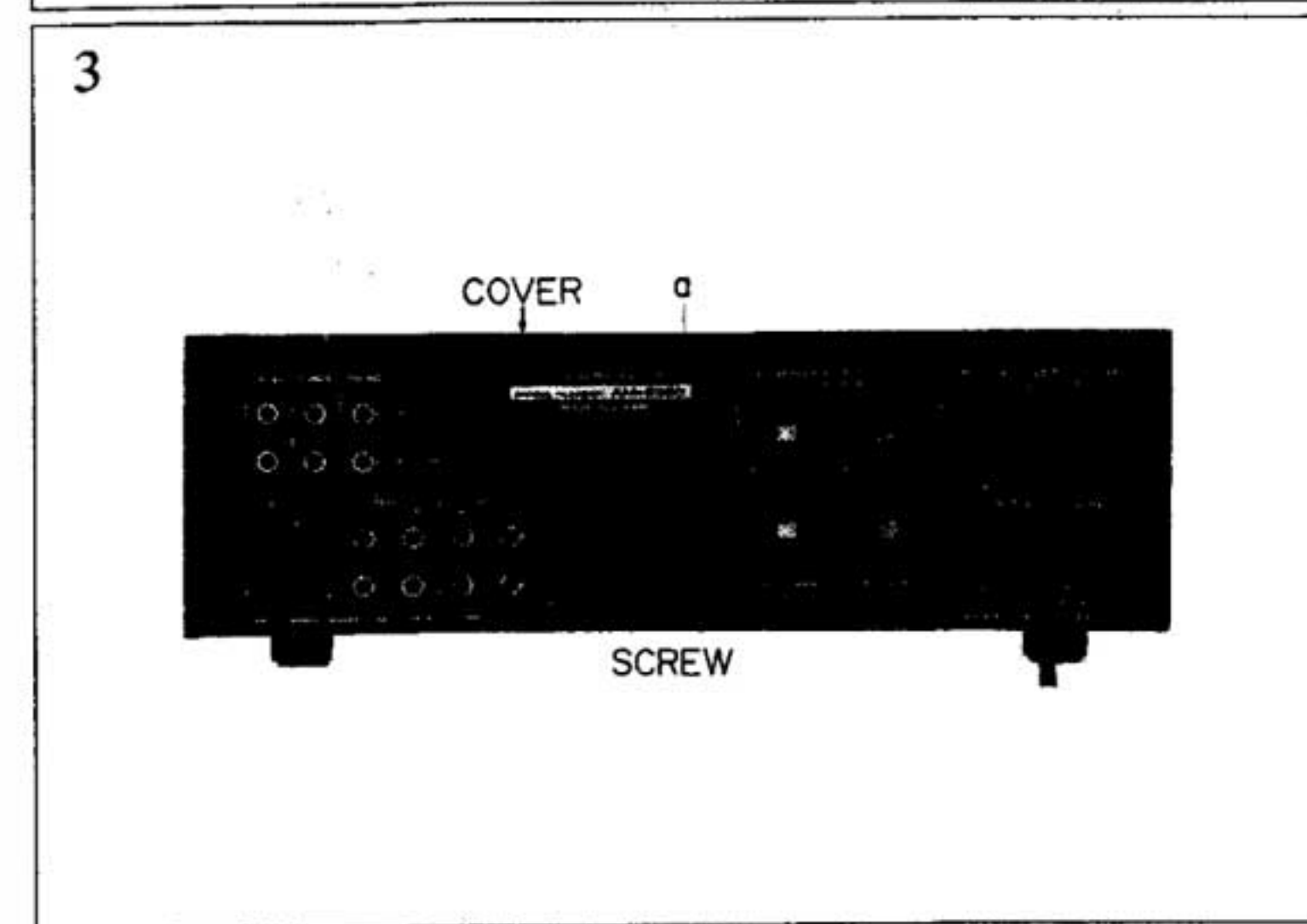
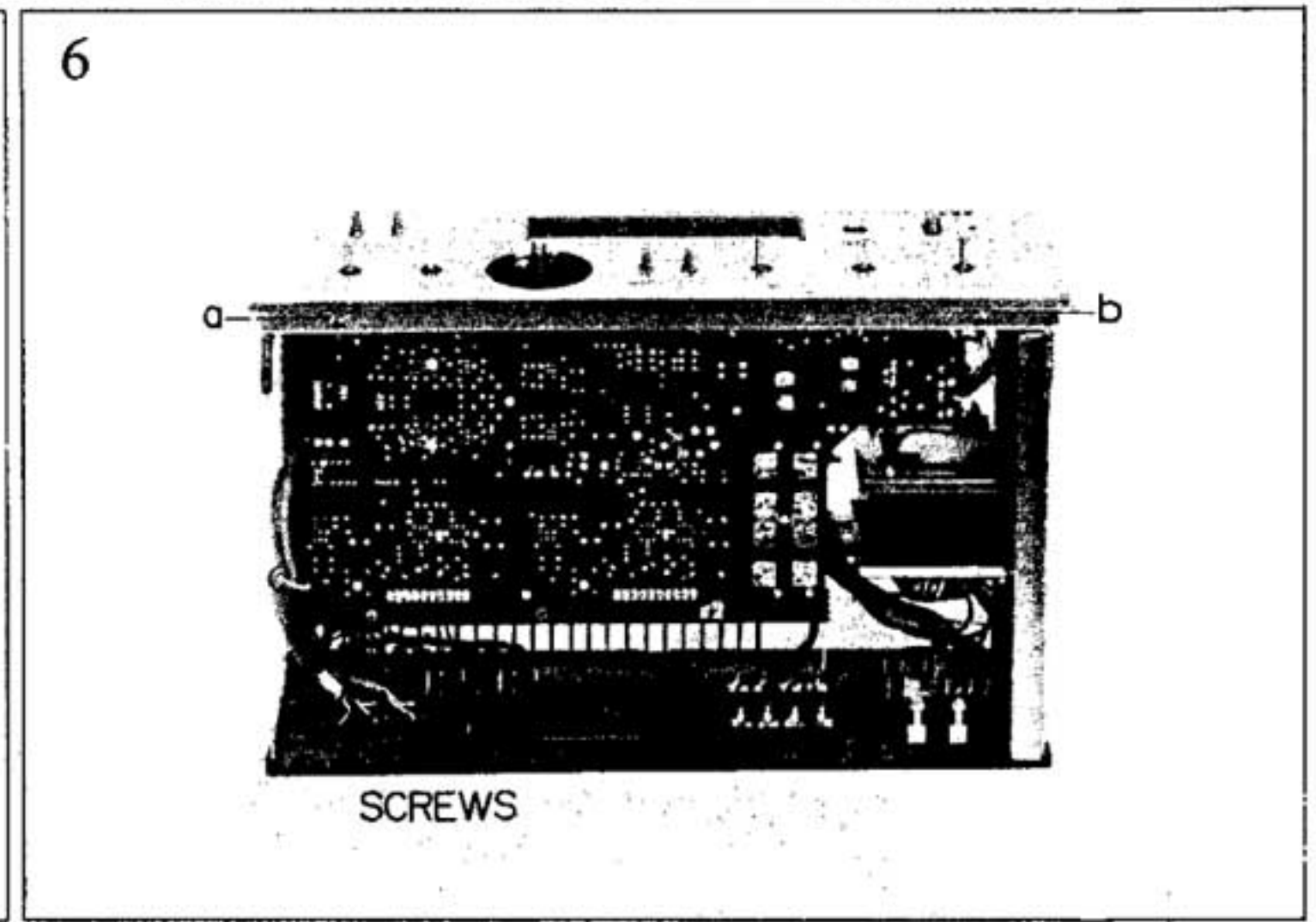
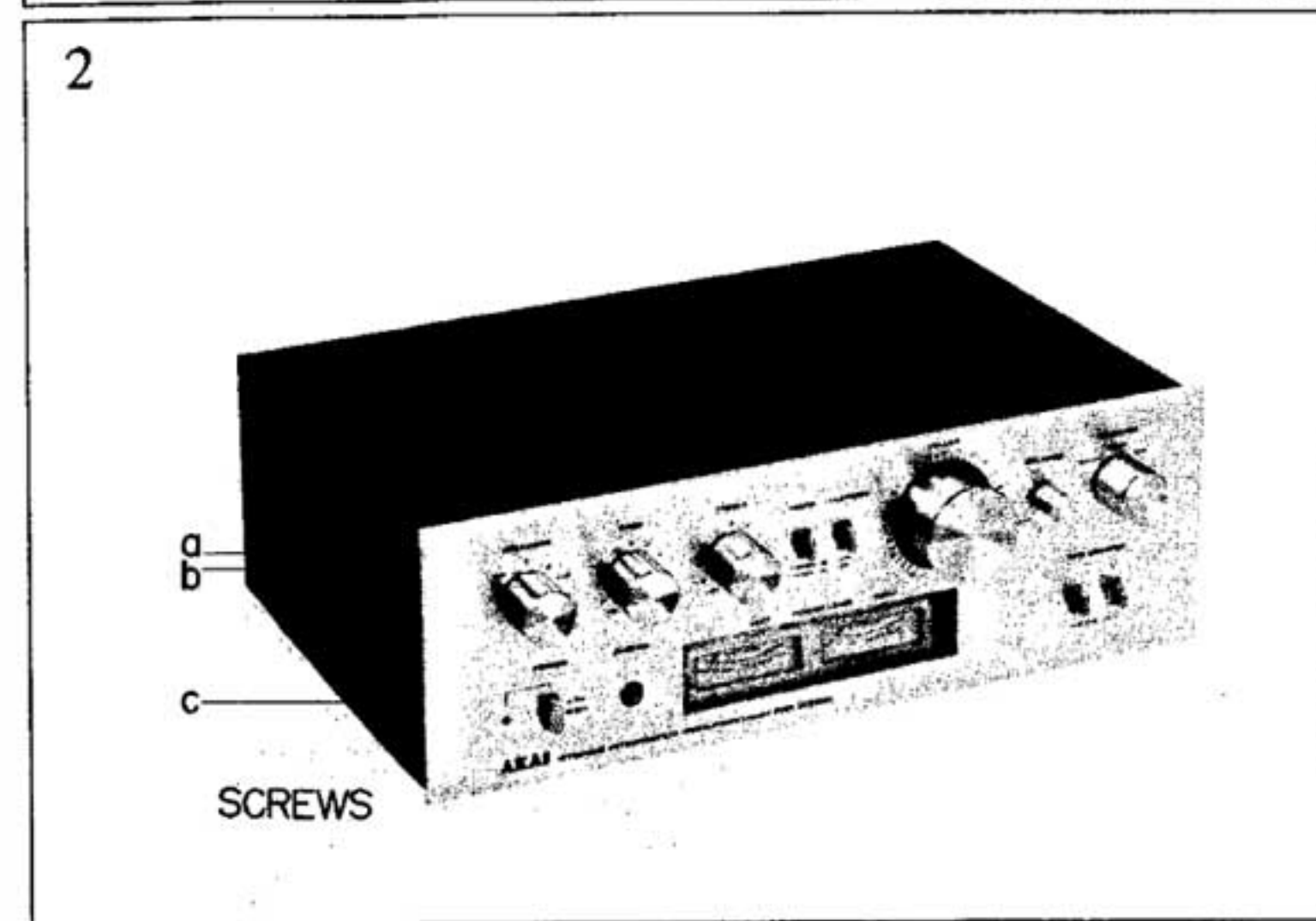
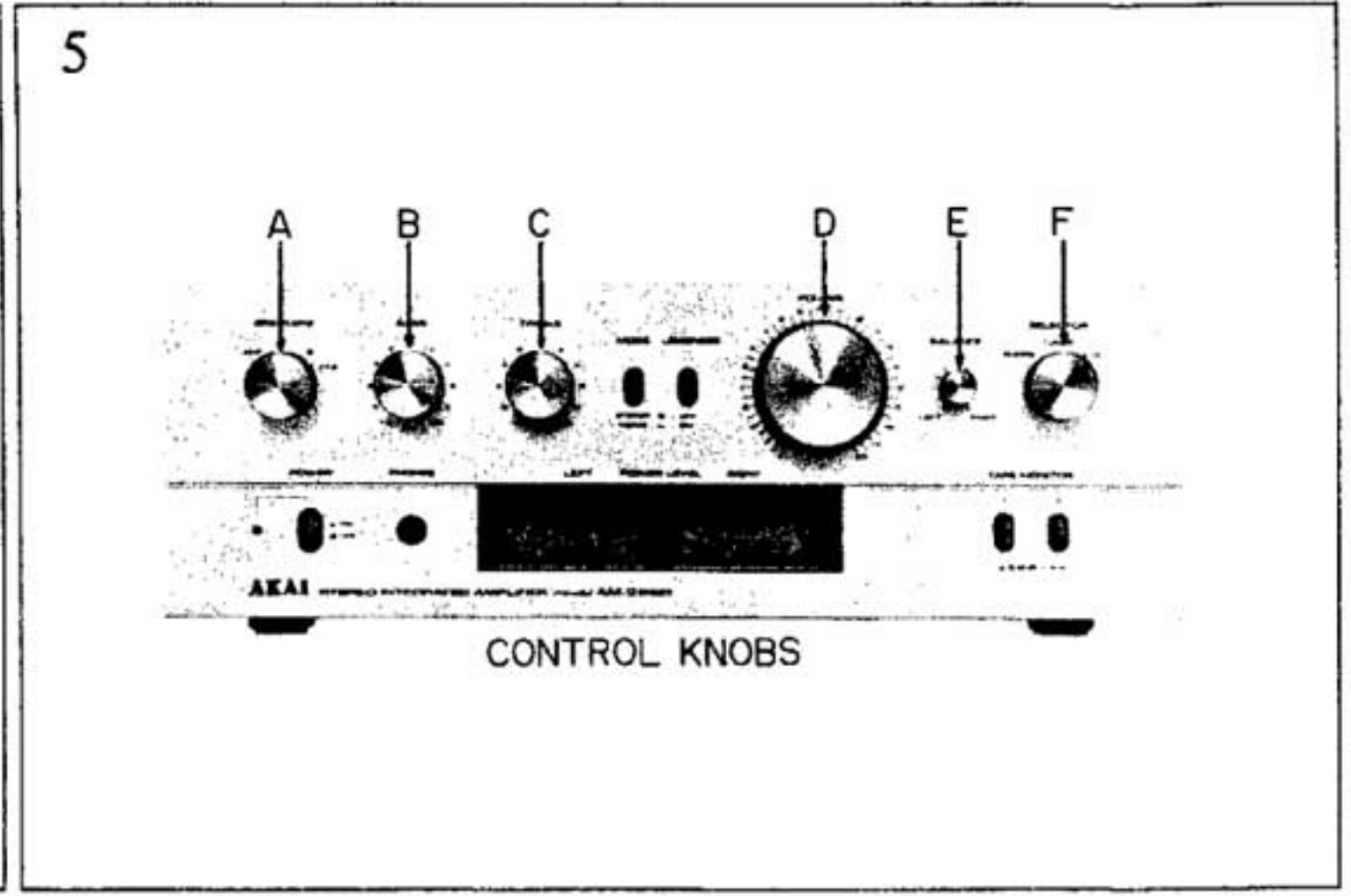

III. CONTROLS

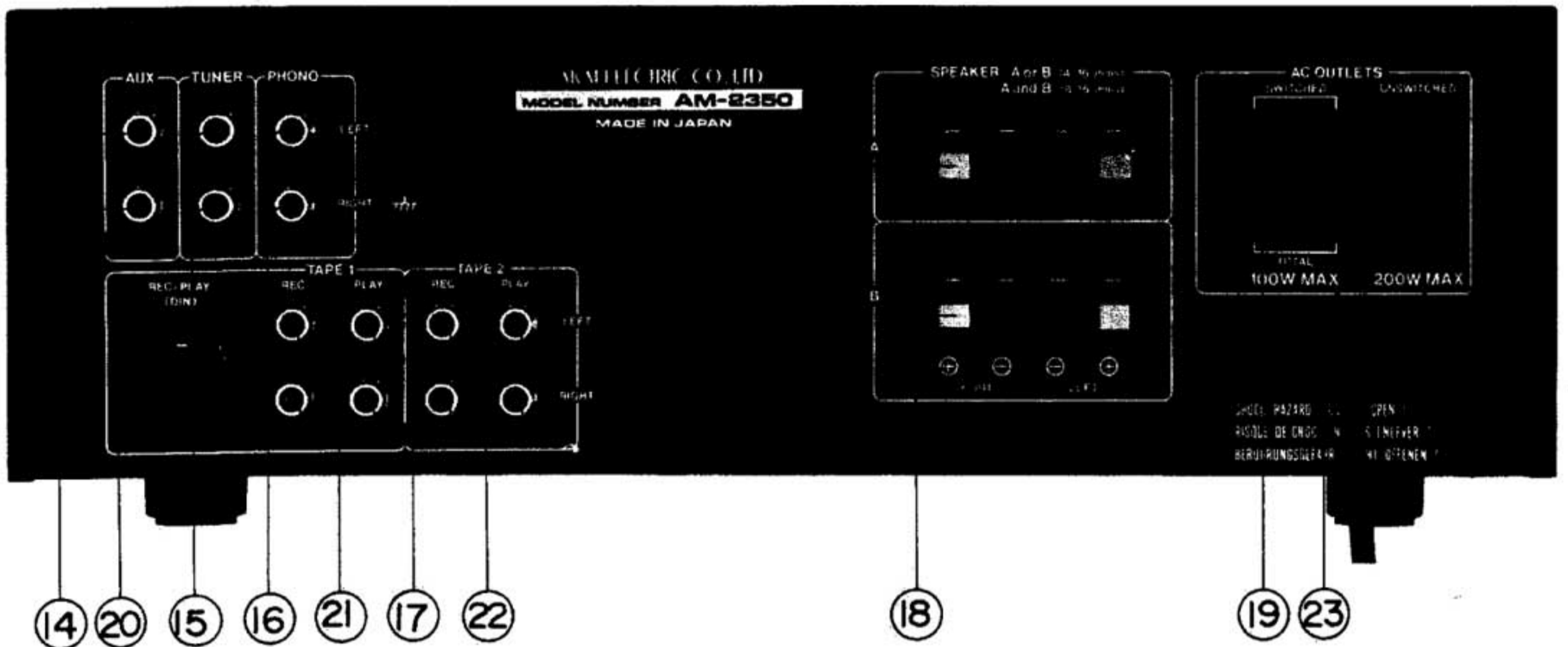
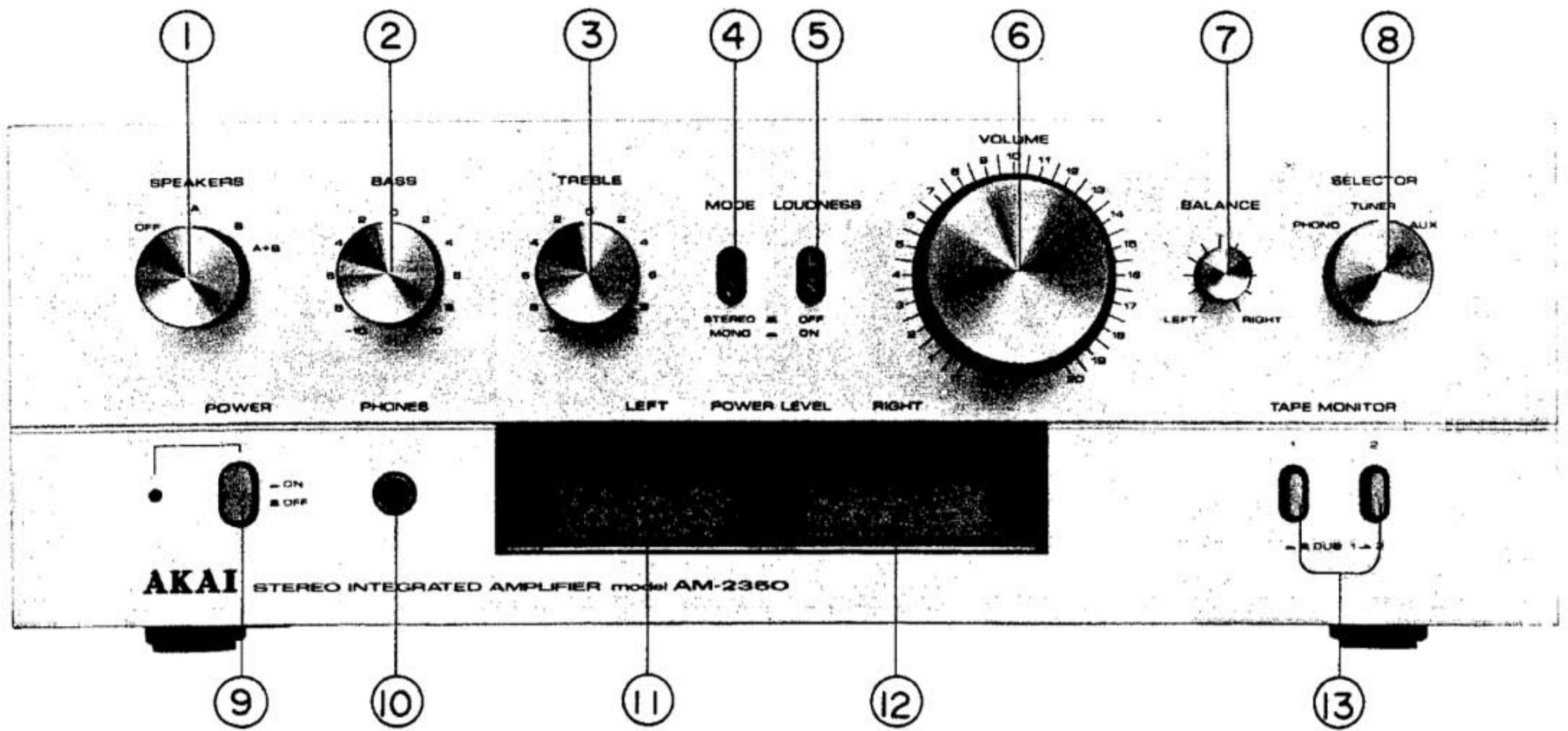

Fig. 1 Front and Rear Panel Controls.

- | | |
|-----------------------------------|------------------------------------|
| 1. SPEAKER SYSTEM SELECTOR SWITCH | 13. TAPE MONITOR SWITCHES |
| 2. BASS CONTROL | 14. AUX TERMINALS |
| 3. TREBLE CONTROL | 15. TUNER TERMINALS |
| 4. MODE SWITCH | 16. PHONO TERMINALS |
| 5. LOUDNESS SWITCH | 17. GROUND TERMINAL |
| 6. VOLUME CONTROL | 18. A & B SYSTEM SPEAKER TERMINALS |
| 7. STEREO BALANCE CONTROL | 19. EXTRA AC OUTLETS |
| 8. SELECTOR SWITCH | 20. TAPE 1 SYSTEM DIN JACK |
| 9. POWER SWITCH | 21. TAPE 1 SYSTEM REC/PB TERMINALS |
| 10. HEADPHONE JACK | 22. TAPE 2 SYSTEM REC/PB TERMINALS |
| 11. POWER LEVEL METER, LEFT | 23. AC CORD |
| 12. POWER LEVEL METER, RIGHT | |

IV. PRINCIPAL PARTS LOCATION

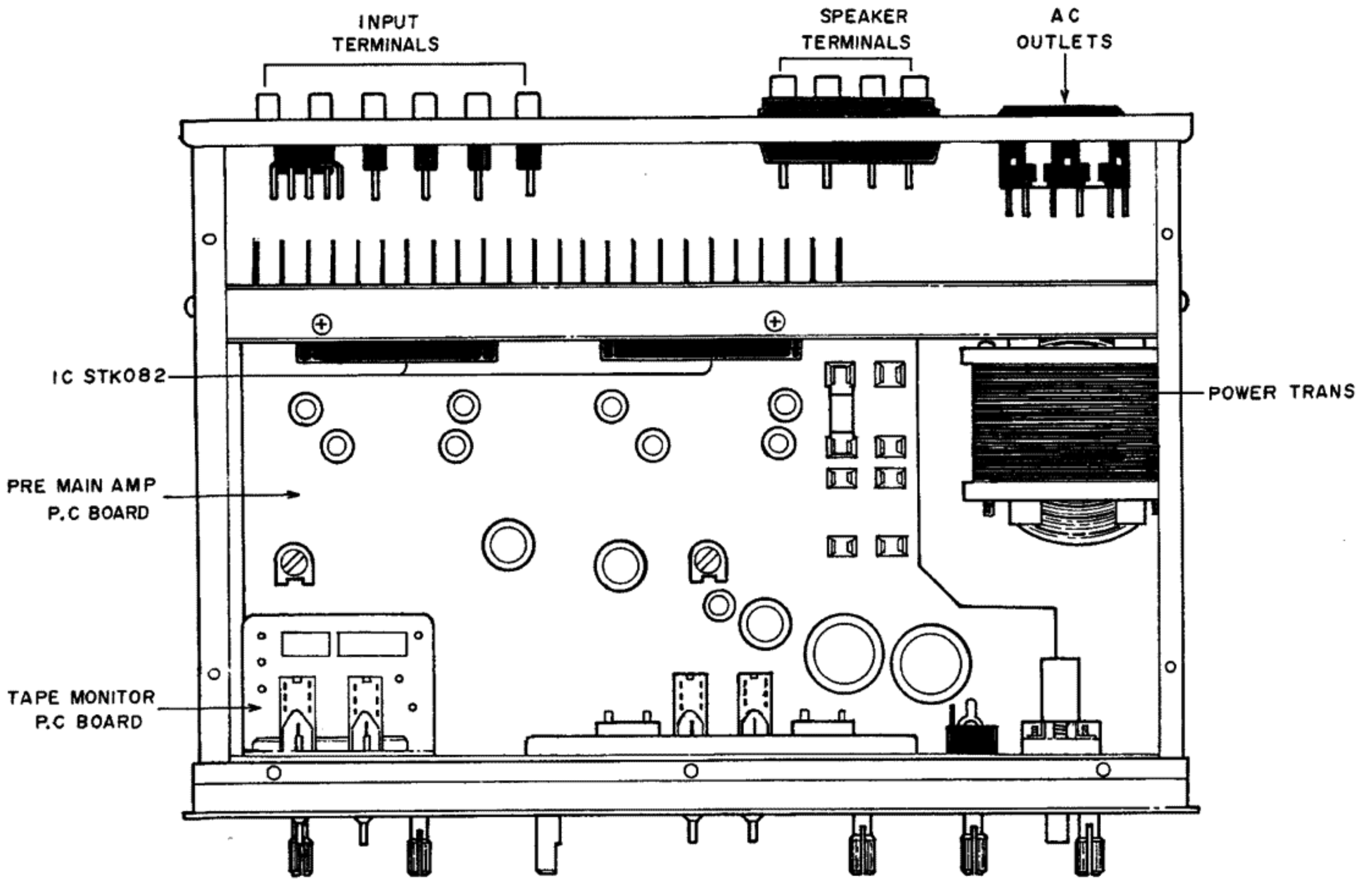

Fig. 2 Bottom View.

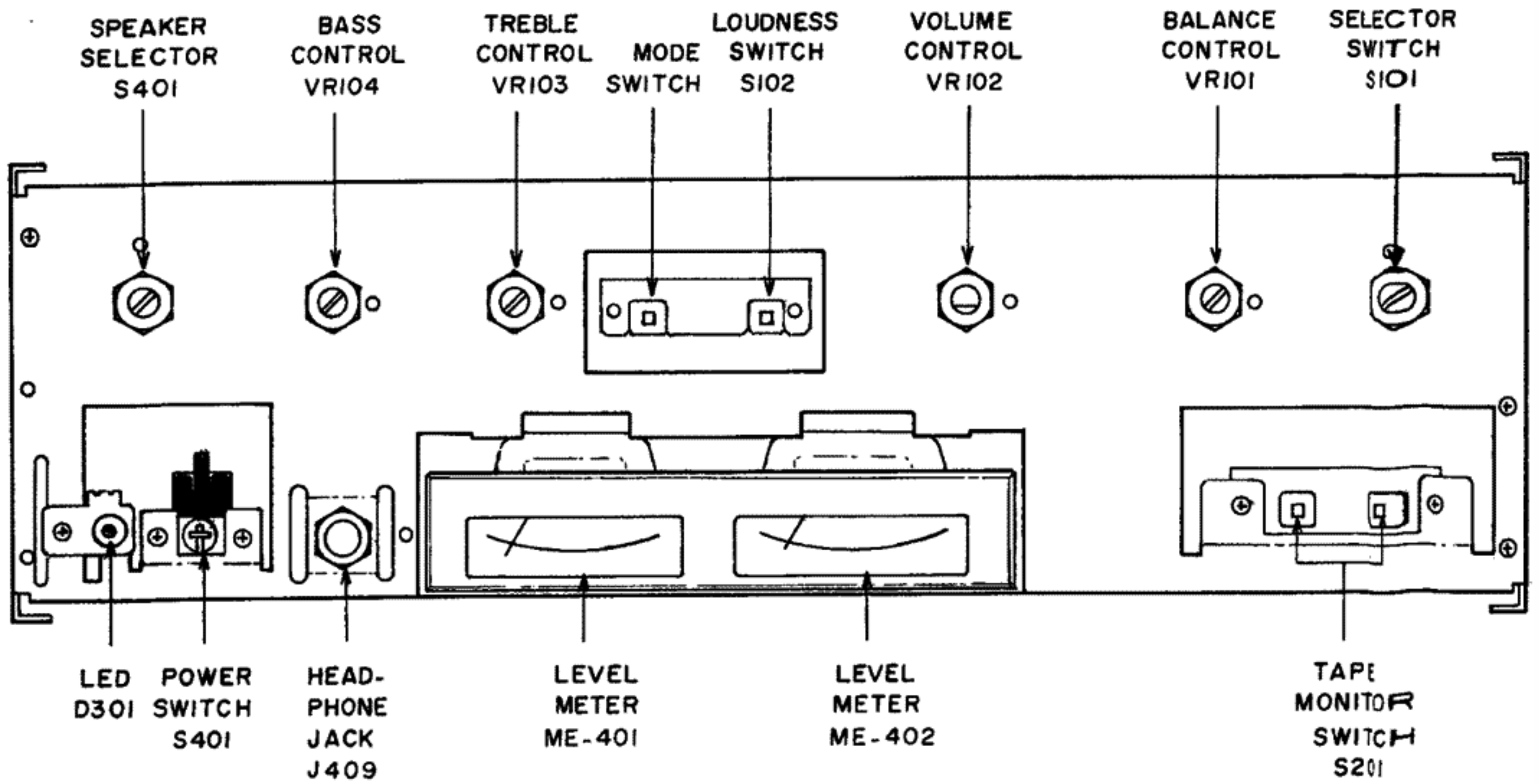

Fig. 3 Front View.

V. BLOCK DIAGRAM AND LEVEL DIAGRAM

LEFT CHANNEL

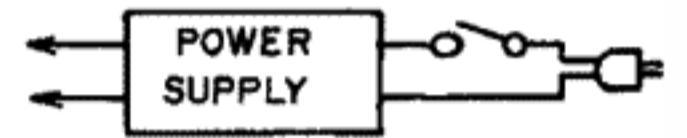
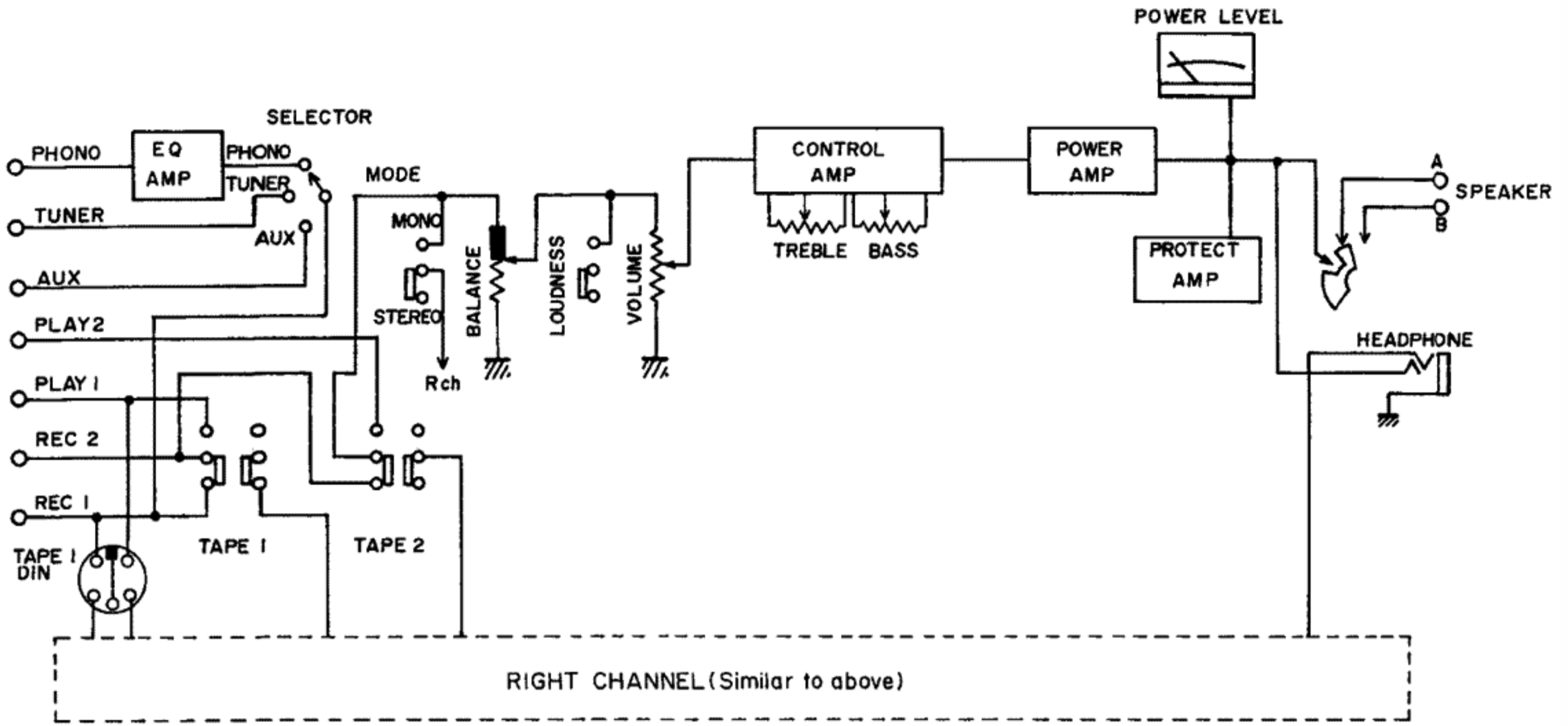

Fig. 4 Block Diagram.

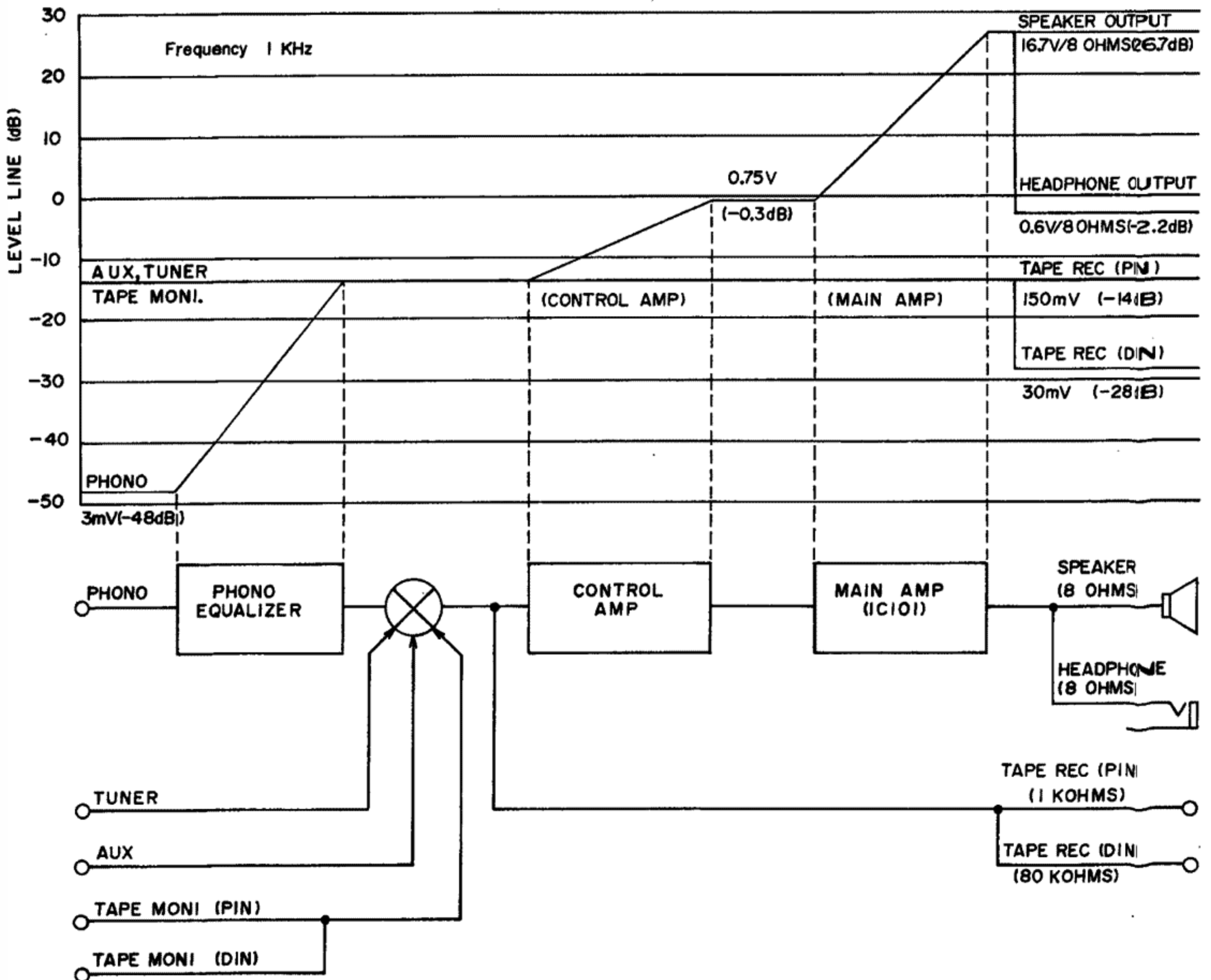

Fig. 5 Level Diagram.

VI. LEVEL METER INDICATION ADJUSTMENT

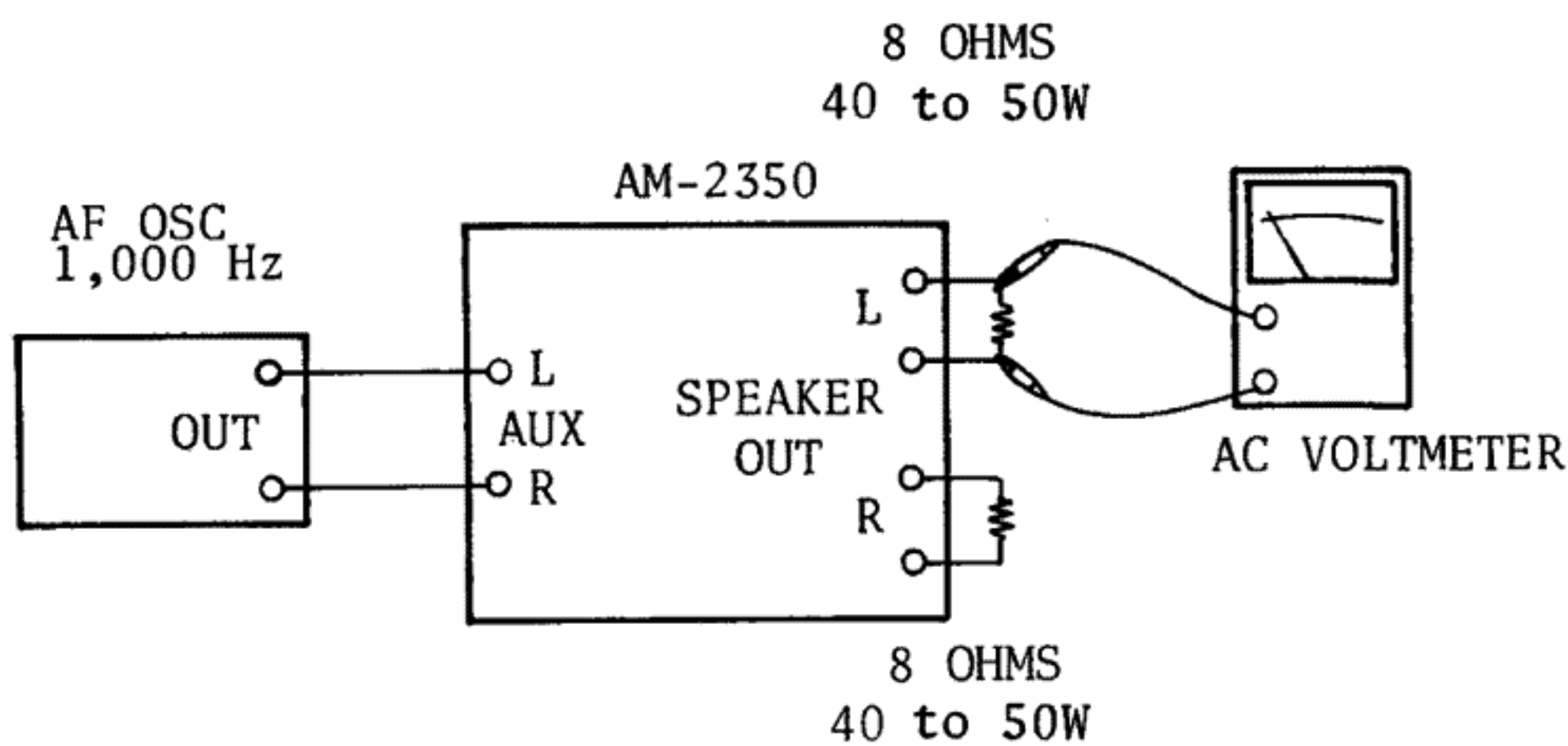

Fig. 6 Instrument Connection.

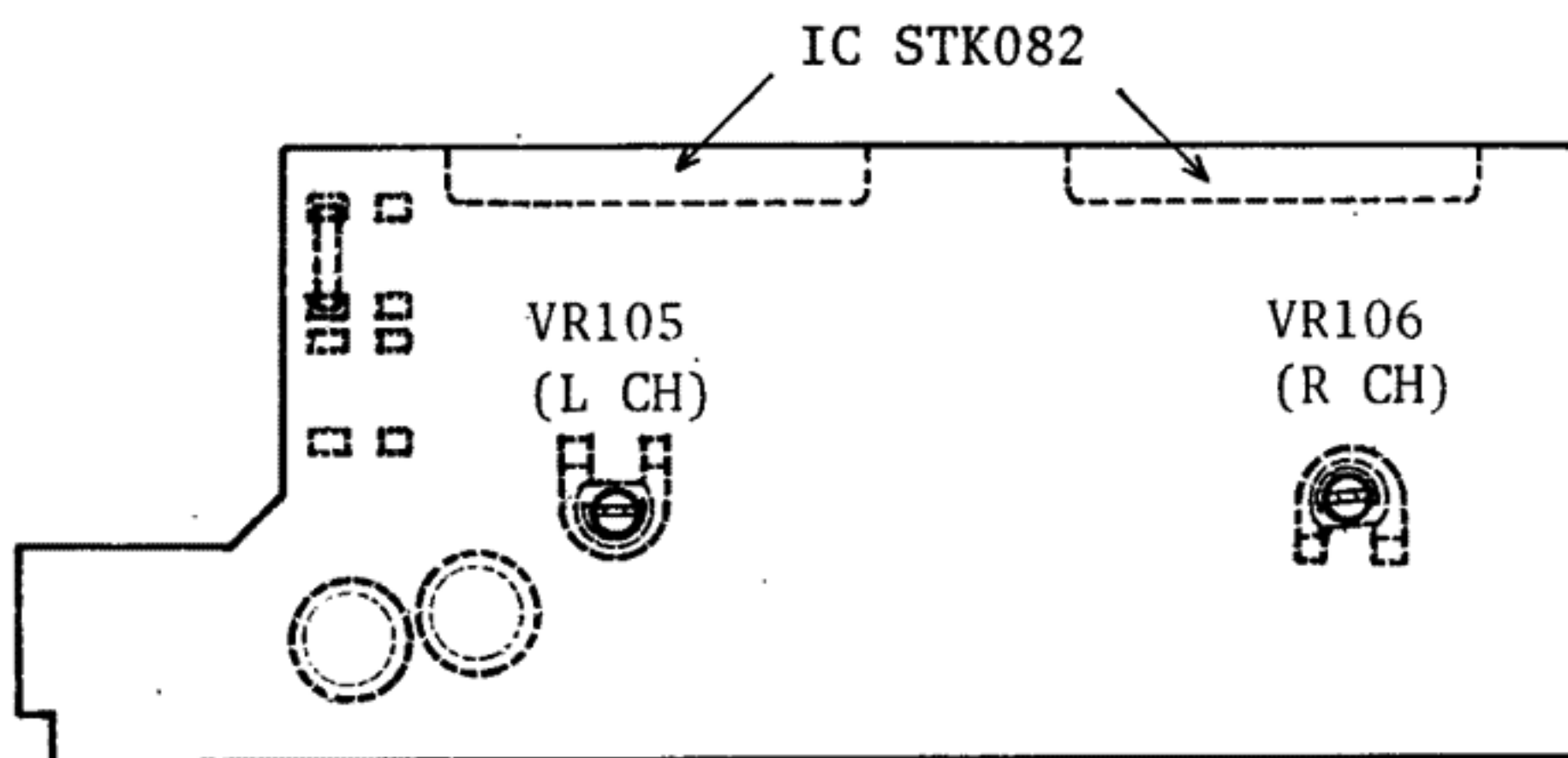

Fig. 7 Adjustment Points.

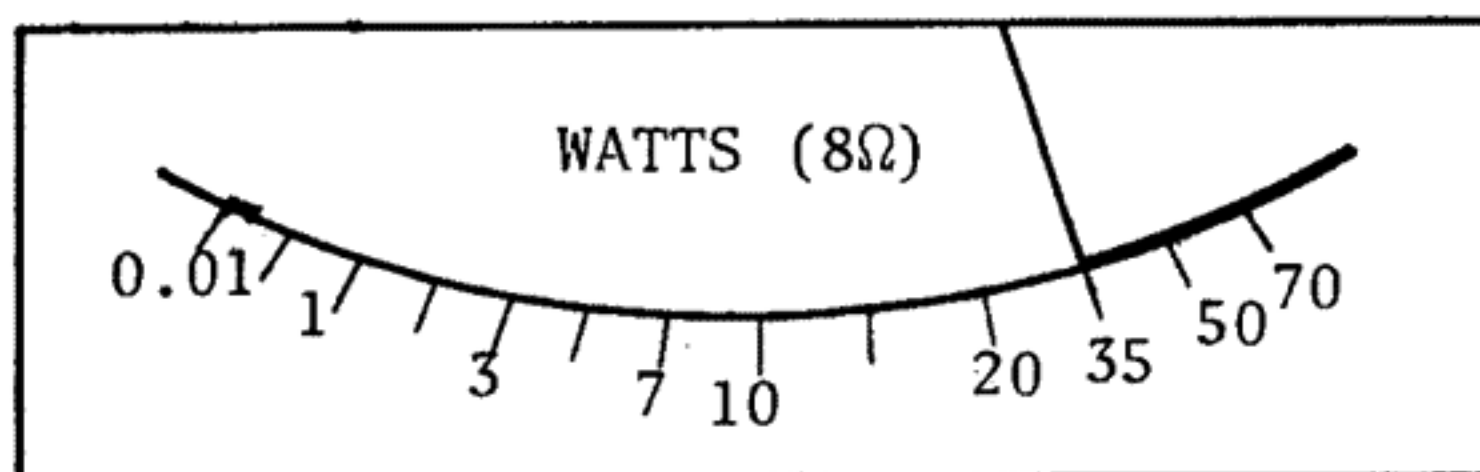

Fig. 8 Level Meter.

Rated output: 35 watts on each channel.

Set-up

1. Connect an AF oscillator to the AUX JACKS on the rear panel of the AM-2350 as shown in Fig. 6.
2. Connect an 8-ohm load across each SPEAKER A terminal as shown.
3. Connect an AC voltmeter across the load.
4. Set the SPEAKERS selector to the A position.
5. Set the BASS, TREBLE, and BALANCE controls to their mechanical centers ('0').
6. Press the MODE pushswitch into the MONO position (in).
7. Keep the LOUDNESS pushswitch in the OFF position (out).
8. Set the SELECTOR switch to the AUX position.

Procedures

1. Turn on the AF oscillator and AM-2350.
2. Set the AF oscillator output frequency to 1,000 Hz and the level to 250 mV.
3. Adjust the VOLUME control on the front panel until the AC voltmeter reads 16.7 V.
4. Now, adjust VR105 (LEFT) and VR106 (RIGHT) on the Pre/Main Amplifier P.C. board (see Fig. 7) until the POWER LEVEL meter deflects to the mark '35' (see Fig. 8).

VII. COMPOSITION OF VARIOUS P.C BOARDS

PRE/MAIN AMP P.C BOARD, SWITCH P.C BOARD & LED P.C BOARD

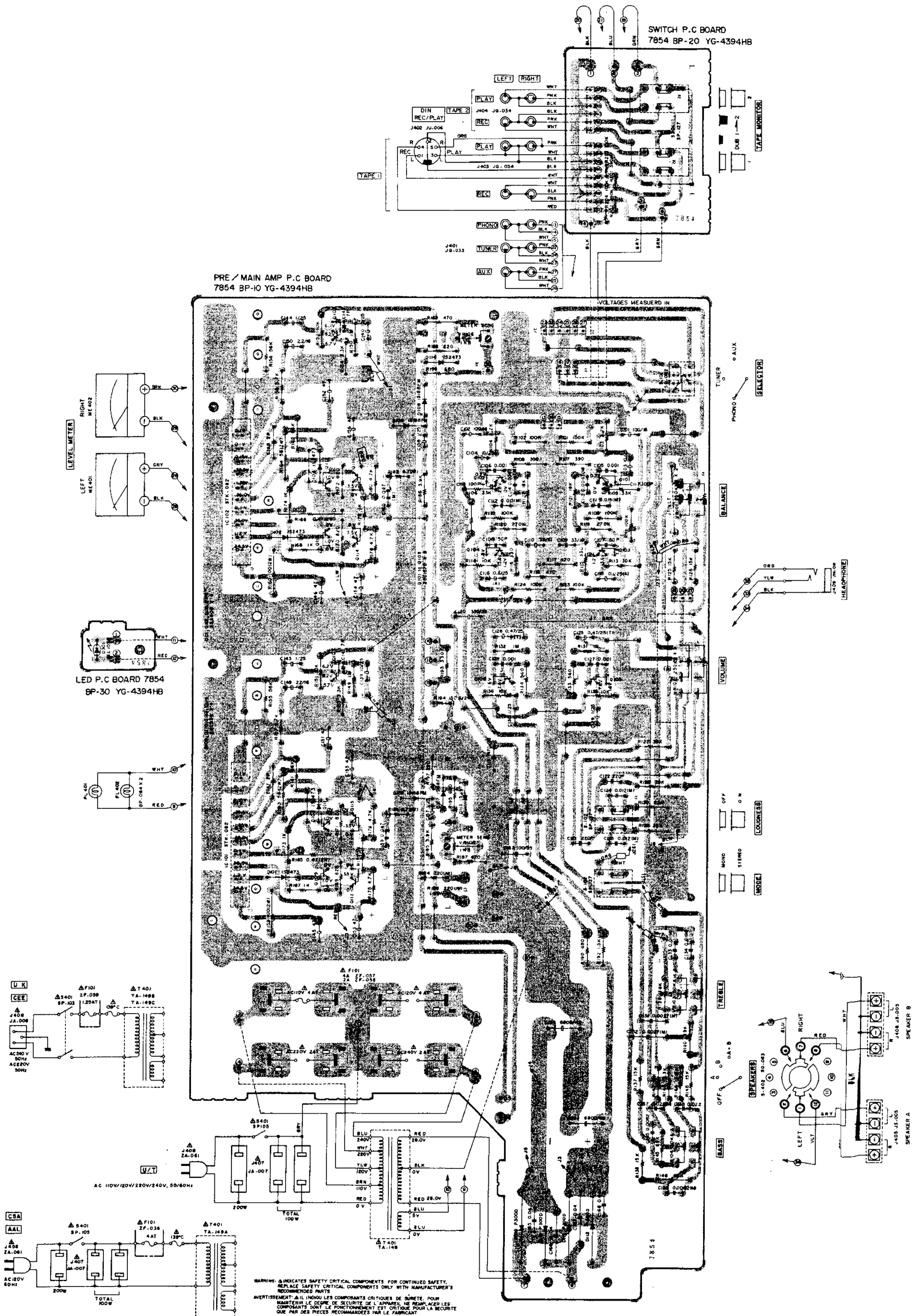

SECTION 2

PARTS LIST

TABLE OF CONTENTS

1. RECOMMENDED SPARE PARTS LIST	14
2. PRE MAIN P.C BOARD BLOCK	15
3. ASSEMBLY BLOCK	16
4. FINAL ASSEMBLY BLOCK	18
INDEX	19

Resistor and Capacitor which is not listed in this parts list, please refer
COMMON LIST FOR SERVICE PARTS.

HOW TO USE THIS PARTS LIST

1. This parts list is compiled by various individual blocks based on assembly process.
2. When ordering parts, please describe parts number, serial number, and model number in detail.
3. How to read list.

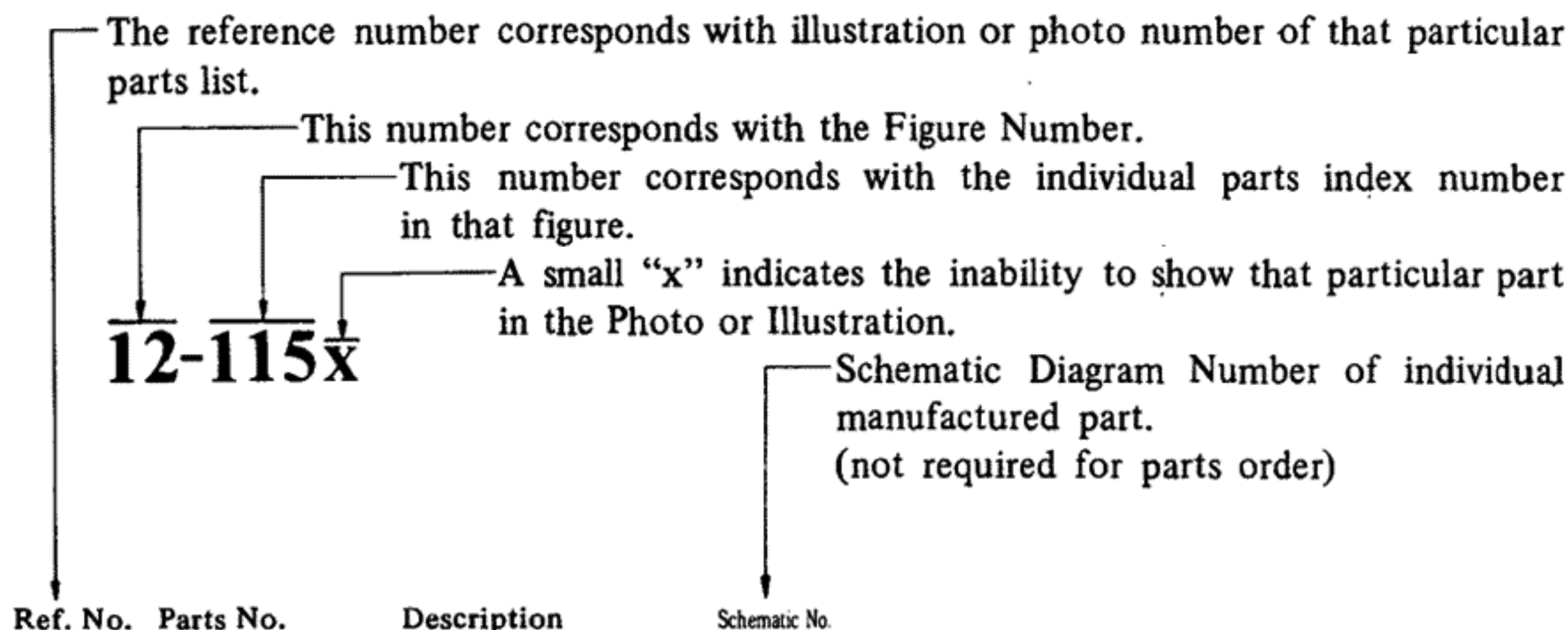

FLYWHEEL BLOCK #13			
12-115x	800425	Flywheel Block Assy. Comp.	RDG #13
12-116	244506	Flywheel Only	RD-233
12-117x	244754	Felt, Flywheel	RD-275
12-118	251324	Main Metal Case	RD-236
12-119	253080	Main Metal	RD-237

4. The symbol numbers shown on the P.C. Board list can be matched with the Composite Views of components of the Schematic Diagram or Service Manual.
5. The indications of Resistors and Capacitors in the photos of P.C. Board are being eliminated.
6. The shape of the parts and parts name, etc. can be confirmed by comparing them with the parts shown on the Electrical Parts Table of P.C. Board.
7. Both the kind of part and installation position can be determined by the Parts Number. To determine where a parts number is listed, utilize Parts Index at end of Parts List.
It is necessary first of all to find the Parts Number. This can be accomplished by using the Reference Number listed at right of parts number in the Parts Index. (meaning of ref. no. outlined in Item 3 above).
8. Utilize separate "Price List for Parts" to determine unit price. The most simple method of finding parts Price is to utilize the reference number.

CAUTION:

1. When placing an order for parts, be sure to list the parts no. model no., and description. There are instances in which if any of this information is omitted, parts cannot be shipped or the wrong parts will be delivered.
2. Please be careful not to make a mistake in the parts no. If the parts no. is in error, a part different from the one ordered may be delivered.
3. Because parts number and parts unit supply in the Preliminary Service Manual (Basic Parts List) may be partially changed, please use this parts list for all future reference.

△ INDICATES SAFETY CRITICAL COMPONENTS. FOR CONTINUED SAFETY, REPLACE SAFETY CRITICAL COMPONENTS ONLY WITH MANUFACTURER'S RECOMMENDED PARTS.

△ IL INDIQU LES COMPOSANTS CRITIQUES DE SURETE. POUR MAINTENIR LE DEGRE DE SECURITE DE L'APPAREIL NE REMPLACER LES COMPOSANTS DONT LE FONCTIONNEMENT EST CRITIQUE POUR LA SECURITE QUE PAR DES PIECES RECOMMANDEES PAR LE FABRICANT.

AC INLET SYSTEM

This model is equipped with an AC INLET SYSTEM. Please refer to the AC INLET SYSTEM CHART below for the specific type. By the AC INLET SYSTEM, AC (mains) cord can be connected to and disconnected from the model because the model is provided with socket exclusively for AC (mains) cord on its main body. Please note, however, that certain models are not equipped with this system and has a built-in AC (mains) cord as before.

AC INLET SYSTEM CHART

CLASS I

CLASS II

☐ This mark indicating double insulation will be attached to machine's rear panel

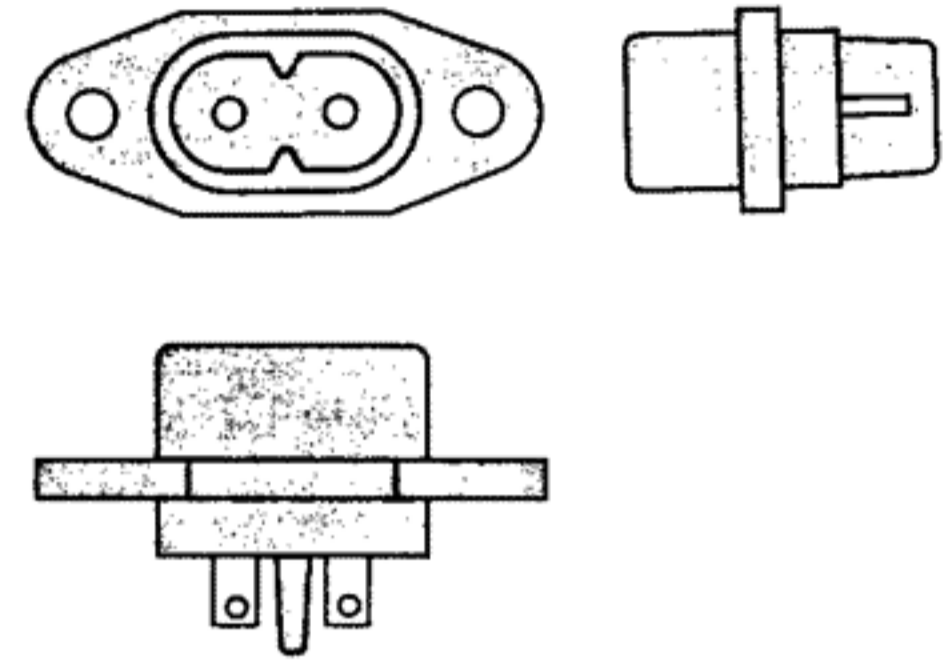
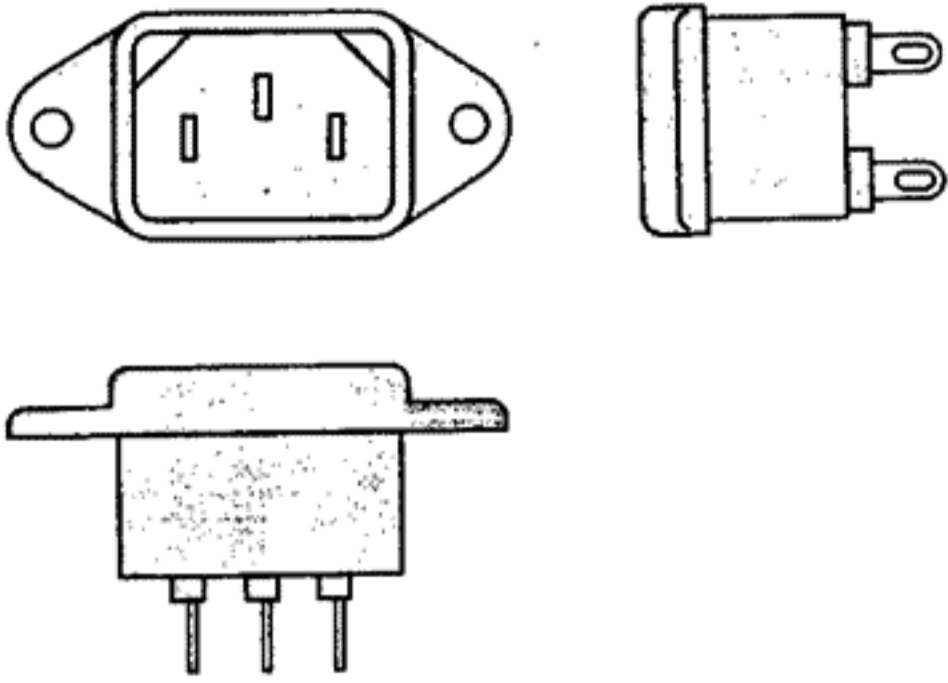

Picture 1
AC INLET
to be
installed
on machines

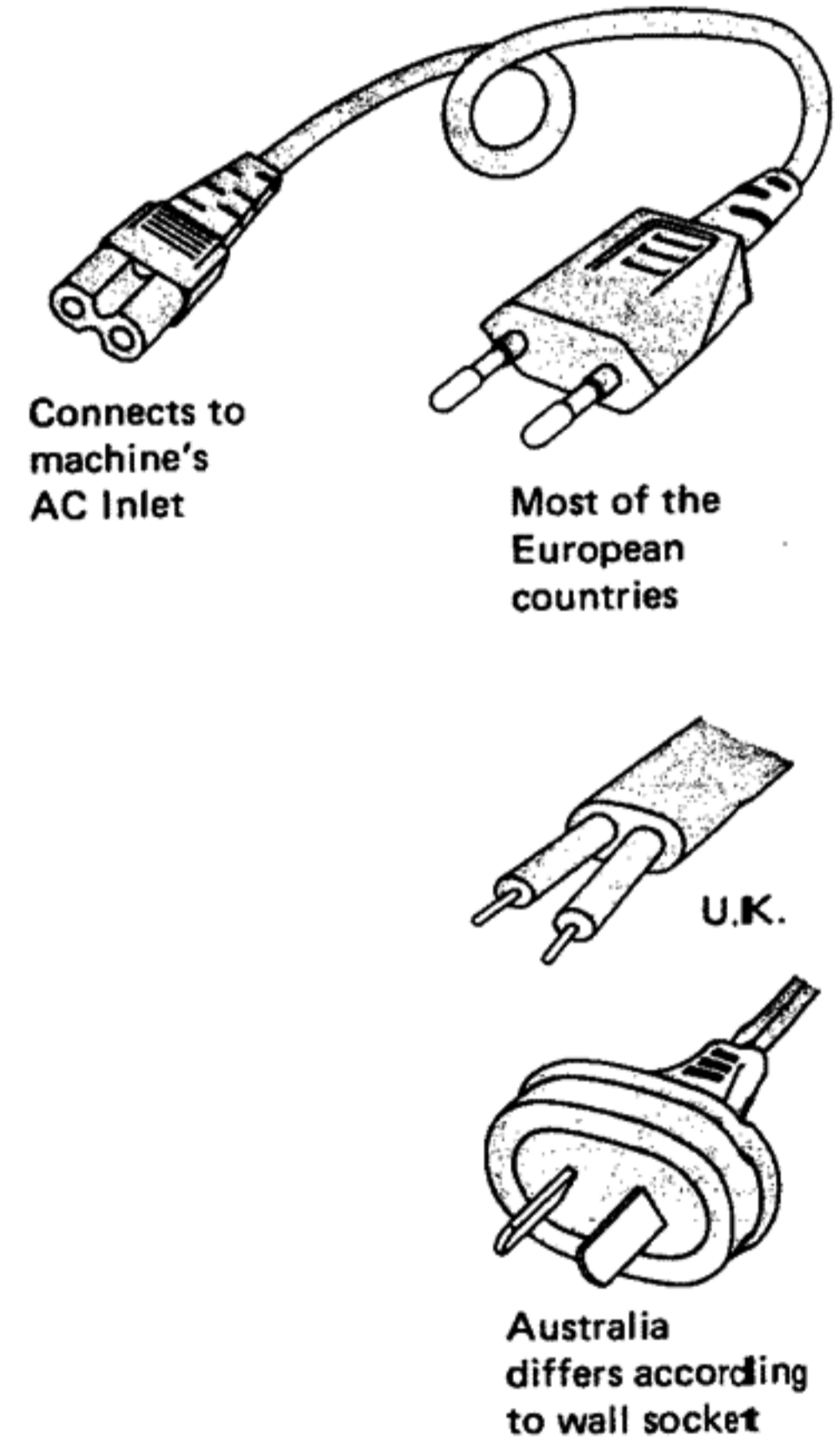
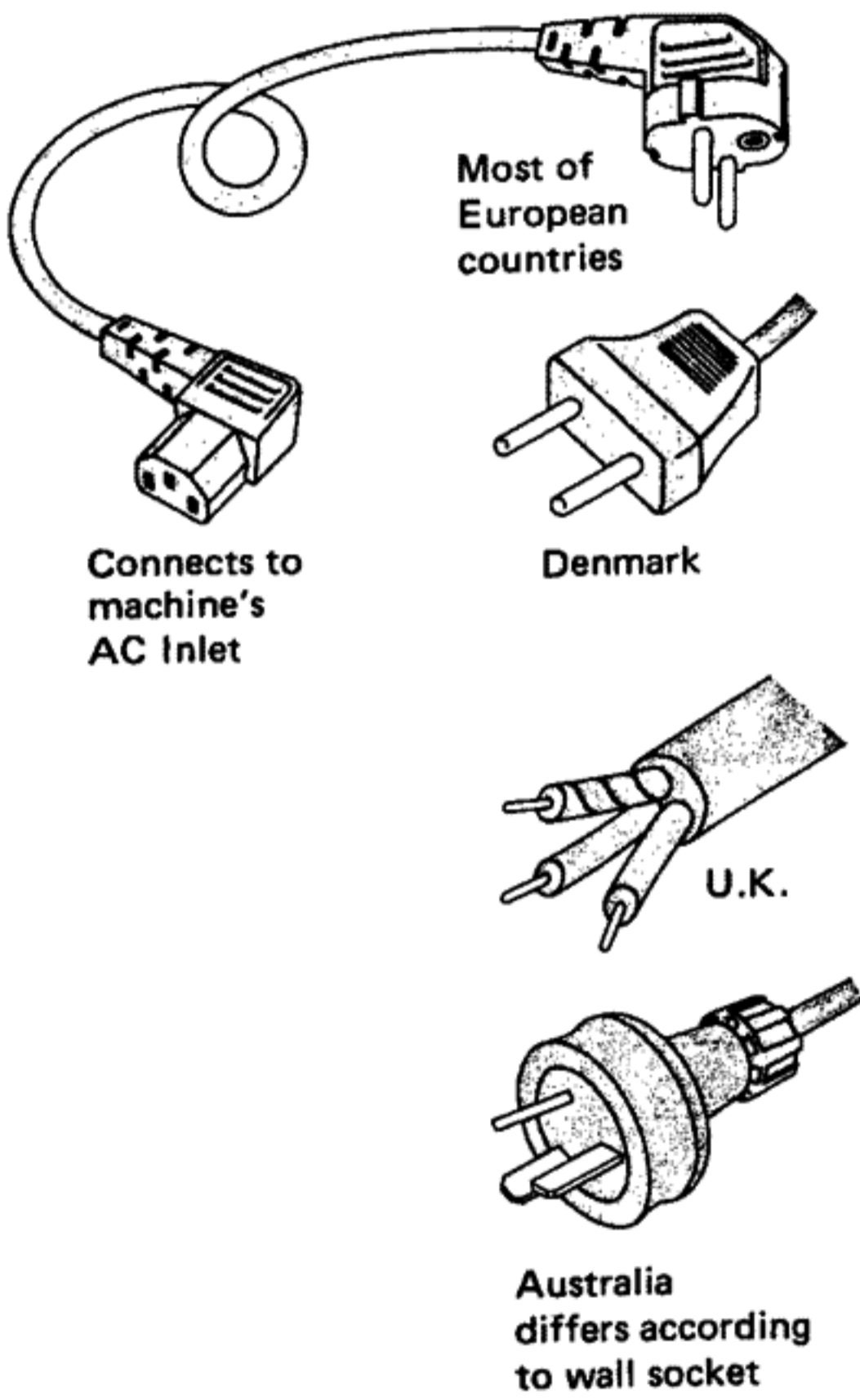

Picture 2
AC (mains)
cord

Parts List for AC (mains) Cord Set

Standard		Description	Type of AC Inlet	Parts No.
Class I	CEE	Cord Set CEE (3 cores)	3P	EW3 02993
	BEAB	Cord Set BEAB (3 cores)	3P	EW3 02994
	SAA	Cord Set SAA (3 cores)	3P	EW3 02996
	U/T	Cord Set U/T (3 cores)	3P	EW3 02646
Class II	CEE	Cord Set CEE (2 cores)	2P	EW6 38144
	BEAB	Cord Set BEAB (2 cores)	2P	EW3 02995
	SAA	Cord Set SAA (2 cores)	2P	EW3 02991
	U/T	Cord Set U/T (2 cores)	2P	EW3 02899

1. RECOMMENDED SPARE PARTS LIST

Because, if the parts listed below are on hand, almost any repair can be accomplished, we suggest that you stock these Recommended Spare Parts Items.

Parts No.	Description	Notes
BA741832	Pre Main P.C Board Comp. AM-2350(CEE, UK)	CEE, UK
BA741831	Pre Main P.C Board Comp. AM-2350(CSA, AAL)	CSA, AAL
BA741830	Pre Main P.C Board Comp. AM-2350(U/T)	U/T
BT741807	△ Power Trans. TA-149 AM-2350 (U/T)	U/T
BT741808	△ Power Trans. TA-149A AM-2350	CSA, AAL
BT741809	△ Power Trans. TA-149C AM-2350 (CEE)	CEE
BT741810	△ Power Trans. TA-149B AM-2350 (UK)	UK
ED741837	Diode P300D AM-2350	
ED741838	Diode 1S188FM AM-2350	
ED656357	LED SEL-105R	D301
ED624903	Silicon Diode 1S2473	
EF561396	△ Fuse UL MF61ML 125V 4A	CSA, AAL
EF563703	△ Fuse 2A 250V	U/T
EF575212	△ Fuse 4A 250V	U/T
EF300583	△ Fuse (EAK) 1.25AT	CEE, UK
EI741833	IC STK-082 AM-2350	
EL741814	Lamp (Reed Type) 6V 200MA AM-2350	
EM-741815	Level Meter MM-049 AM-2350(S)	
EM-741816	Level Meter MM-050 AM-2350(BL)	BL
ES-741843	Push SW. SP-127 AM-2350	S102
ES741843	Push SW. SP-127 AM-2350	S201
ES741842	Rotary Slide SW. AM-2350	S101
ES741813	Rotary SW. SQ-063 AM-2350	
ES314977	△ Push SW. ESB-70304T	U/T, CSA, AAL
ES315487	△ Push SW. ESB-7097	CEE, UK
ET741834	Transistor 2SA608F AM-2350	
ET741835	Transistor 2SC1570G AM-2350	
ET741836	Transistor 2SC1570H AM-2350	
ET403402	Transistor 2SC536(G)	
EV741839	Vol. 250 kBx2 AM-2350	
EV741840	Vol. 250 kBx2 AM-2350	
EV741841	Vol. 50 kAx2 AM-2350	

2. PRE MAIN P.C BOARD BLOCK

Symbol No.	Parts No.	Description	Schematic No.
1	BA741830	Pre Main P.C Board Comp. AM-2350(U/T)	7854BP100K
2	BA741831	Pre Main P.C Board Comp. AM-2350(CSA,AAL)	7854BP120K
3	BA741832	Pre Main P.C Board Comp. AM-2350(CEE,UK)	7854BP110K
IC101,102	EI741833	IC STK-082 AM-2350	STK082
Q101to106	ET741835	Transistor 2SC1570G AM-2350	2SC1570G
Q107,108	ET741836	Transistor 2SC1570H AM-2350	2SC1570H
Q109,110	ET403402	Transistor 2SC536(G)	45-1-55
Q111,112	ET741834	Transistor 2SA608F AM-2350	2SA608F
D101to104	ED624903	Silicon Diode 1S2473	45-3-28
D105to108	ED741838	Diode 1S188FM AM-2350	1S188FM
D109to112	ED741837	Diode P300D AM-2350	P300D
D113,114	ED624903	Silicon Diode 1S2473	45-3-28
VR101	EV741839	Vol. 250kBHx2 AM-2350	36-22-47
VR102	EV741840	Vol. 250kBx2 AM-2350	36-22-46
VR103,104	EV741841	Vol. 50kAx2 AM-2350	36-22-45
VR105,106	EV316442	Semi-Fixed/Vol. D8 Axial 1kB	36-10-282
S102	ES741842	Rotary Slide SW. AM-2350	25-6-178
S102	ES741843	Push SW. SP-127 AM-2350	25-5-334
J103	EJ741786	H Connector JC-024-3P2 AM-2350	JC0243P2
J104	EJ741897	H Connector JC-024-3P3 AM-2350	JC0243P3
C115,116	EC619650	Solid Aluminum/C. (Vert. Type) 0.1 μ F (K) 25WV	24-19-2
C125,126	EC741844	Tantalum/C. 0.47 μ F 25WV AM-2350	24-15-15
C163,164	EC741852	Elect./C. 6800 μ F 42WV AM-2350	24-12-51
R159,160	ER741847	Non-Inflammable/R. 2W 100 ohms(K) AM-2350	RS2PY1000HMK
R163,164	ER741846	Non-Inflammable/R. 2W 56 ohms(K) AM-2350	RS2PY560HMK
R165,166	ER741845	Fuse/R. 2W 0.47 ohm(K) AM-2350	35-17-18
R181,182	ER741848	Non-Inflammable/R. 1W 4.7 ohms(K) AM-2350	35-15-20
R183,184	ER741849	Non-Inflammable/R. 1W 220 ohms(K) AM-2350	35-15-20
R190	ER741850	Non-Inflammable/R. 1W 680 ohms(K) AM-2350	35-15-20
R192	ER741851	Non-Inflammable/R. 1W 1.5K(K) AM-2350	35-15-20
4	ZS609153	Tapping Screw #2, 3x16(PAN)	
5	ZS490228	Tapping Screw #2 3x8(BIND)	
F101	EF575212	Δ Fuse 4A 250V	39-1-50
F101	EF300583	Δ Fuse (EAK) 1.25AT	39-1-59
F101	EF563703	Δ Fuse 2A 250V	39-1-50
F101	EF561396	Δ Fuse ULMF61ML 125V 4A	39-1-40
S201	ES741843	Push SW. SP-127 AM-2350	25-5-334
6	EA741853	SW. P.C Board AM-2350 (U/T)	7854BP20
7	EA741854	SW. P.C Board AM-2350 (CEE, UK)	7854BP21
8	EA741855	SW. P.C Board AM-2350 (CSA,AAL)	7854BP22
D301	ED656357	LED SEL-105R	45-15-11

3. ASSEMBLY BLOCK

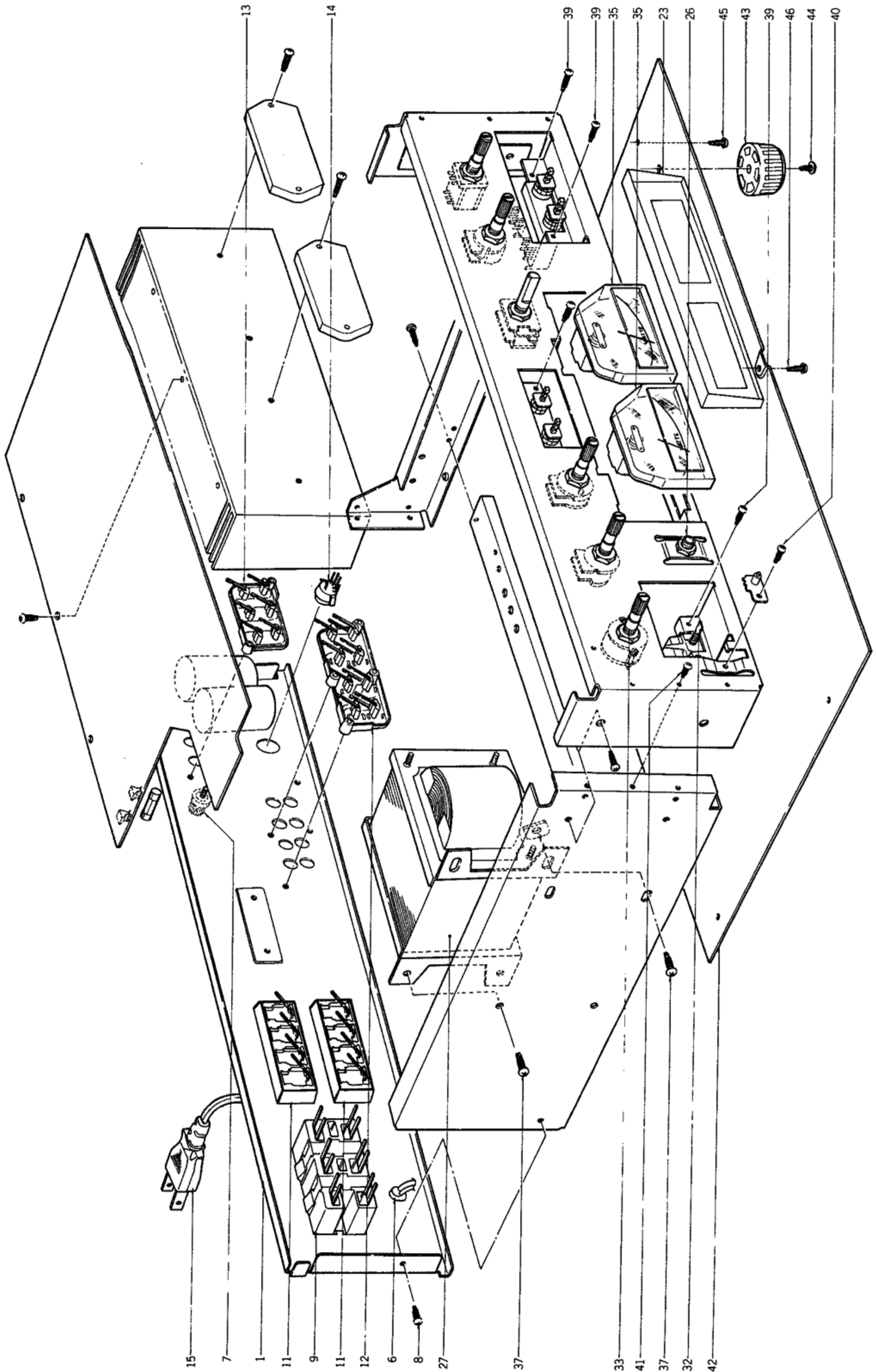

3. ASSEMBLY BLOCK

Ref. No.	Parts No.	Description	Schematic No.
REAR PANEL BLOCK			
1	SP741790	Rear Panel AM-2350(U/T)	7854A03
2x	SP741791	Rear Panel AM-2350(CSA)	7854A11
3x	SP741792	Rear Panel AM-2350(AAL)	7854A10
4x	SP741793	Rear Panel AM-2350(CEE)	7854A09
5x	SP741794	Rear Panel AM-2350(UK)	7854A08
6	EZ741795	Strain Relief 7717D09 AM-2350	7717D09
7	SK741796	Knob AM-2350	JT028
8	ZS483502	Screw, Pan Head 3x13	
9	EJ240535	△3-Throw AC Outlet	31-1-173
10x	EJ296853	△3P In-Let CM-3	31-1-199
11	EJ306942	4P Push Terminal 5-02361	32-1-86
12	EJ741798	6P Pin Jack JG-033 AM-2350	JG033
13	EJ741799	4P Pin Jack JG-034 AM-2350	JG034
14	EJ741800	Din Jack JU-006 AM-2350	JU006
15	EW374894	△AC Cord U/T	26-3-19
16x	EW207742	△AC Cord CUL	26-3-45
17x	ZS421740	Screw, Pan Head 3x8 (Black)	
18x	ZS302945	S-Tight Screw, 3x8 (Pan) (Black)	
19x	ZW245856	Washer D4.2x9x0.8T	
20x	EJ741789	H Connector JC-024-3P1	
		AM-2350	JC0243P1
21x	EJ741801	H Connector JC-024-9P	
		AM-2350	JC0249P
22x	EJ741817	H Connector JC-024-6P1	
		AM-2350	JC0246P1
ASSEMBLY BLOCK			
23	TA741803	Meter Escutcheon (S)	
		AM-2350(S)	2350001
24x	TA741804	Meter Escutcheon (BL)	
		AM-2350(BL)	2350002
25x	TA741805	Rubber Bush AM-2350	475 D01
26	EJ741806	Headphone Jack JH-011	
		AM-2350	JH011
27	BT741807	△Power Trans. TA-149	
		AM-2350(U/T)	38-4-730
28x	BT741808	△Power Trans. TA-149A	
		AM-2350	38-4-727
29x	BT741809	△Power Trans. TA-149C	
		AM-2350(CEE)	38-4-729
30x	BT741810	△Power Trans. TA-149B	
		AM-2350(U/K)	38-4-728
31x	ES315487	△Push SW. ESB-7097	25-5-319
32	ES314977	△Push SW. ESB-70304T	25-5-332
33	ES741813	Rotary SW. 063	25-6-179
34x	EL741814	Lamp (Reed Type) 6V 200mA	
		AM-2350	BP084
35	EM741815	Level Meter KL-243X-42	
		AM-2350(S)	46-1-227
36x	EM741816	Level Meter KL-243X-43	
		AM-2350(BL)	46-1-228
37	ZS416687	Screw, Binding Head 4x8	
38x	ZS301398	S-Tight Screw, 4x8 (Bind)	
39	ZS379350	Screw, Pan Head 3x6	
40	ZS490228	Tapping Screw #2 3x8 (Bind)	
41	ZS666336	Tapping Screw #2 3x8 (Pan)	
42	SP741826	Bottom Plate AM-2350	7854A18
43	SA312465	Circular Foot (A)	CA-6014
44	ZS301398	S-Tight Screw, 4x8 (Bind)	
45	ZS300277	Tap-Tight Screw, 4x6 (Bind)	
46	ZS490228	Tapping Screw, #2 3x8 (Bind)	

4. FINAL ASSEMBLY BLOCK



4. FINAL ASSEMBLY BLOCK

Ref. No.	Parts No.	Description	Schematic No.
FRONT PANEL BLOCK			
1	BD741782	Front Panel (S) Block Comp. AM-2350	
2x	BD741783	Front Panel (BL) Block Comp. AM-2350BL	
3	TA741784	Meter Plate AM-2350	784B01
4	SK306864	Push Button	M:2523
5x	SK306866	Push Button (BL)	M:2523
6	SK305653	Push Button (A)	CI-6309
7x	SK305656	Push Button (D)	CI-6309
8	SE306863	Button Escutcheon	M:2522
9	SE306143	Button Escutcheon (A)	CI-6308
10x	SE306144	Button Escutcheon (A-BL)	CI-6308
11	MZ306840	Vol. Plate (Black)	M:2506
12x	ZG306867	Taper Spring	M:2524
13x	ZG305657	Button Spring	CI-6310
FINAL ASSEMBLY BLOCK			
14	BC741819	Upper Cover AM-2350 (U/T, CSA, CEE, UK)	784A04
15x	BC741827	Upper Cover AM-2350 (AAL)	784A19
16	SK741820	Vol. Knob Part AM-2350(S)	784A05
17x	SK741821	Vol. Knob Part AM-2350(BL)	784A14
18	SK741822	Knob Part AM-2350(S)	784A06
19x	SK741823	Knob Part AM-2350(BL)	784A15
20	SK741824	Knob Part AM-2350(S)	784A07
21x	SK741825	Knob Part AM-2350(BL)	784A16
22	ZS741787	Tap-Tight Screw, 4x8 (BIND) AM-2350	M4:8
23x	ZS302945	S-Tight Screw, 3x8 (PAN) (Black)	
24x	ZS741828	Tap-Tight Screw, 3x6 (BIND) AM-2350	M3:6

INDEX

Parts No.	Ref. No. & Symbol No.	Parts No.	Ref. No. & Symbol No.	Parts No.	Ref. No. & Symbol No.	Parts No.	Ref. No. & Symbol No.	Parts No.	Ref. No. & Symbol No.
BA741830	1	SK741824	20						
BA741831	2	SK741825	21x						
BA741832	3	SP741790	1						
BC741819	14	SP741791	2x						
BC741827	15x	SP741792	3x						
BD741782	1	SP741793	4x						
BD741783	2x	SP741794	5x						
BT741807	27	SP741826	42						
BT741808	28x	TA741784	3						
BT741809	29x	TA741803	23						
BT741810	30x	TA741804	24x						
EA741853	6	TA741805	25x						
EA741854	7	ZG305657	13x						
EA741855	8	ZG306867	12x						
EC619650	C115,116	ZS300277	45						
EC741844	C125,126	ZS301398	38x						
EC741852	C163,164	ZS301398	44						
ED624903	D101to104	ZS302945	18x						
ED624903	D113,114	ZS302945	23x						
ED656357	D301	ZS379350	39						
ED741837	D109to112	ZS416687	37						
ED741838	D105to108	ZS421740	17x						
EF300583	F101	ZS483502	8						
EF561396	F101	ZS490228	40						
EF563703	F101	ZS490228	46						
EF575212	F101	ZS609153	4						
EI741833	IC101,102	ZS666336	41						
EJ240535	9	ZS741787	22						
EJ296853	10x	ZS741828	24x						
EJ306942	11	ZW245856	19x						
EJ741786	J103								
EJ741789	20x								
EJ741798	12								
EJ741799	13								
EJ741800	14								
EJ741801	21x								
EJ741806	26								
EJ741817	22x								
EJ741897	J104								
EL741814	34x								
EM741815	35								
EM741816	36x								
ER741845	R165,166								
ER741846	R163,164								
ER741847	R159,160								
ER741848	R181,182								
ER741849	R183,184								
ER741850	R190								
ER741851	R192								
ES314977	32								
ES315487	31x								
ES741813	33								
ES741842	S102								
ES741843	S102								
ES741843	S201								
ET403402	Q109,110								
ET741834	Q111,112								
ET741835	Q101to106								
ET741836	Q107,108								
EV316442	VR105,106								
EV741839	VR101								
EV741840	VR102								
EV741841	VR103,104								
EW207742	16x								
EW374894	15								
EZ741795	6								
MZ306840	11								
SA312465	43								
SE306143	9								
SE306144	10x								
SE306863	8								
SK305653	6								
SK305656	7x								
SK306864	4								
SK306866	5x								
SK741796	7								
SK741820	16								
SK741821	17x								
SK741822	18								
SK741823	19x								

SECTION 3

SCHEMATIC DIAGRAM

AM-2350 No. 1562008A SCHEMATIC DIAGRAM



WARNING: Δ INDICATES SAFETY CRITICAL COMPONENTS. FOR CONTINUED SAFETY, REPLACE SAFETY CRITICAL COMPONENTS ONLY WITH MANUFACTURER'S RECOMMENDED PARTS.
 AVERTISSEMENT: Δ IL INDIQUE LES COMPOSANTS CRITIQUES DE SÛRETÉ. POUR MAINTENIR LE DEGRÉ DE SÛRETÉ DE L'APPAREIL, NE REMPLACER LES COMPOSANTS DONT LE FONCTIONNEMENT EST CRITIQUE POUR LA SÛRETÉ QUE PAR DES PIÈCES RECOMMANDÉES PAR LE FABRICANT.

NOTE:
 UNLESS OTHERWISE SPECIFIED
 RESISTORS IN OHMS 1/4W(J)AND
 CAPACITORS IN μF 50WV(J)
 * THERMAL PROTECTOR INCLUDED
 IN THE POWER TRANSFORMER TA-149C