

AKAI M-9

OPERATOR'S MANUAL

CROSS-FIELD HEAD
FOUR TRACK STEREOPHONIC
TAPE RECORDER

I GENERAL INFORMATION

1. Specifications	2
2. Controls.....	3
3. Cross-Field Head	5
4. Recording/Playback for 4-track	6
5. Operational Precautions	7
6. Voltage and Cycle Conversion.....	8
7. Selection of Tape Speeds	9
8. Playback using External Speakers...	10
9. DIN (One Multiple-Connection) Jack	10
10. Tape Cleaner	11

I OPERATING INSTRUCTIONS

1. Threading the Tape.....	12
2. Stereo Playback	12
3. Automatic Stop/Shut-Off	13
4. Instant Stop Control	13
5. Stereo Recording	14
6. Recording from Stereo Broadcast...	15
7. Recording from Stereo Discs.....	15
8. Monaural Recording on Tracks No. 1-4	15
9. Monaural Recording on Tracks No. 3-2	16
10. Monaural Playback	17
11. Tape Erasing	17

12. Fast Forward and Rewind.....	18
13. Monitoring	18
14. Tape Splicing and Editing.....	18
15. Cleaning Head	19
16. Head Demagnetization	21
17. Tape Duplication	21
18. Sound on Sound	22
19. Transistor Protection	23

II ACCESSORIES

1. Accessories Optional.....	24
2. Accessories Standard.....	25

IV SCHEMATIC

1. SPECIFICATIONS

I GENERAL INFORMATION AKAI M-9

Tape Speed	: 1-7/8, 3-3/4 and 7-1/2 ips (15 ips with 15 ips adaptor kit)
Wow and Flutter	: Less than 0.10% RMS at 7-1/2 ips Less than 0.13% RMS at 3-3/4 ips Less than 0.20% RMS at 1-7/8 ips
Frequency Response	: 30 to 23,000 cps ± 3 db at 7-1/2 ips 30 to 18,000 cps ± 3 db at 3-3/4 ips 30 to 9,000 cps ± 3 db at 1-7/8 ips
Signal to Noise Ratio	: Better than 50 db
Input Level	: Mic more than 0.5 mV Line..... more than 60 mV
Power Output	: 15 W maximum per each channel at undistorted power, total 30 W 20 W maximum per each channel at music power, total 40 W
Equalization	: Correct equalization for playback of tapes recorded to the NARTB curve.
Recording Level Indicator	: VU meter $\times 2$
Recording System	: 4-track stereo/monaural, CROSS-FIELD bias system
Fast Forward and Rewind Time	: 90 seconds using 1,200 feet tape at 50 cycles. 75 seconds at 60 cycles.
Recording Capacity	: 8 hours monaural recording at 1-7/8 ips (1,200 feet tape) 4 hours stereo recording at 1-7/8 ips.
Maximum Reel Size	: 7" reel
Head	: Recording/playback head 4-track stereo/monaural, impedance 1.2 K ohms at 1,000 cps Bias head 4-track stereo, low impedance 500 ohms at 60 KC Erase head..... 4-track stereo, low impedance 500 ohms at 60 KC
Motor	: Hysteresis synchronous 2-speed motor
Speaker	: 4" speaker $\times 2$ (M-9)
Transistor	: Transistor $\times 20$ Thermister $\times 4$ Rectifier $\times 4$
Power Supply	: AC 100 to 240 V, 50/60 cycles
Power Consumption	: 100 VA
Dimensions	: 20" H \times 13" W \times 9-1/2" D (508 H \times 340 W \times 240 D mm)
Weight	: 41.8 lbs (19 kg) (M-9)

AKAI M-9

2. CONTROLS

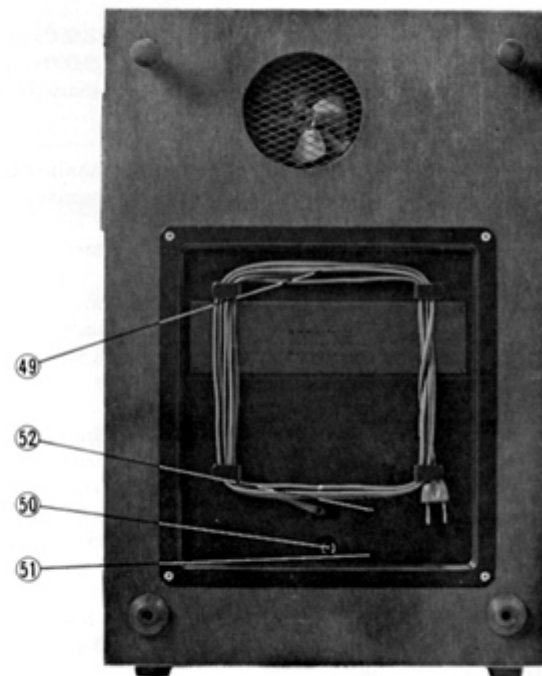
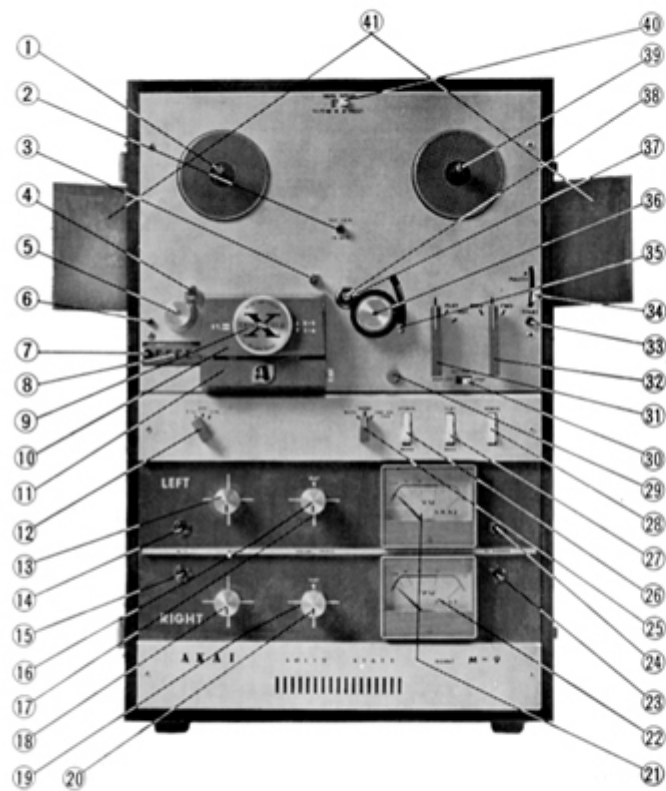

CONTROLS

AKAI M-9

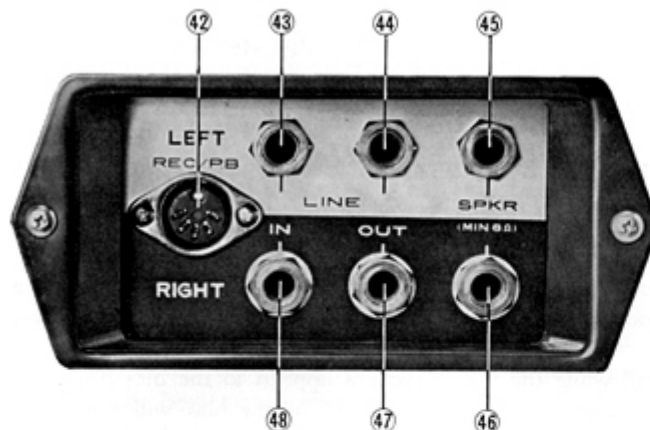

- ① Supply Reel Shaft
- ② Cycle Conversion Switch (A)
- ③ Capstan Storage Post
- ④ Tape Cleaner
- ⑤ Tape Guide
- ⑥ Cleaner Button
- ⑦ Reset Button
- ⑧ Index Counter
- ⑨ Track Selector Knob
- ⑩ Head Cover (A)

- ⑪ Head Cover (B)
- ⑫ Equalizer Knob
- ⑬ Recording Level Control Knob (Left)
- ⑭ Microphone Jack (Left)
- ⑮ Microphone Jack (Right)
- ⑯ Volume Control Knob (Left)
- ⑰ Treble Control Knob (Left)
- ⑱ Recording Level Control Knob (Right)
- ⑲ Treble Control Knob (Right)
- ⑳ Volume Control Knob (Right)
- ㉑ VU Meter (Left)
- ㉒ VU Meter (Right)
- ㉓ Stereo Headphone Jack (A)
- ㉔ Stereo Headphone Jack (B)
- ㉕ Recording Mode Switch
- ㉖ Function Switch
- ㉗ Bass Switch
- ㉘ Power Switch
- ㉙ Record Safety Button
- ㉚ Automatic Stop/Shut-Off Switch

- ㉛ Record/Playback Knob
- ㉜ Fast Forward/Rewind Knob
- ㉝ Start Button
- ㉞ Instant Stop Lever
- ㉟ Automatic Shut-Off Lever
- ㊱ Pinch Wheel
- ㊲ Capstan
- ㊳ Capstan Shaft
- ㊴ Take-up Reel Shaft
- ㊵ Speed Change Switch
- ㊶ Speaker Reflectors
- ㊷ DIN Jack
- ㊸ Line Input Jack (Left)
- ㊹ Line Output Jack (Left)
- ㊺ External Speaker Jack (Left)
- ㊻ External Speaker Jack (Right)
- ㊼ Line Output Jack (Right)
- ㊽ Line Input Jack (Right)
- ㊾ AC Cord
- ㊿ Fuse Post
- ⑤① Cycle Conversion Switch (B)
- ⑤② Voltage Conversion Switch

3. CROSS-FIELD HEAD

Cross-field head creates a sensation in the tape recorder world by making a wide range of recording which has never been heard before of any tape recorder

Using this cross-field head, Model M-9 provides a surprising recording performance (30-23,000 cps at a tape speed of 7-1/2 ips, 30-18,000 cps at 3-3/4 ips and 30 to 9,000 cps at 1-7/8 ips).

What is superior about cross-field recording? How does it differ from typical recording methods as far as construction is concerned? On these, explanation is given below in sequences:

In the typical recording system, the signal current and the bias current are combined together and applied to the recording head. (Refer to Diagram 1.)

It is well known that the purpose of bias current is recording at high sensitivity with a signal applied on the tape, with no distortion and minimizing noise generation.

However, the bias current providing such an advantage also has an undesirable character. That is, the wide magnetic field of the bias current affects the recorded signal, resulting in weakening or even erasing the signal. This phenomenon is particularly noticeable at high frequencies.

In the cross-field system, the signal current is applied to the recording head while the bias current is applied to the bias head.

These two heads are located in different positions, as determined inter-relatively, so the magnetic field of the bias will not affect the signal recorded on the tape, even when a sufficient bias is applied. This allows the recorded signal to remain on the tape with high fidelity.

Diagram 1. Ordinary recording system

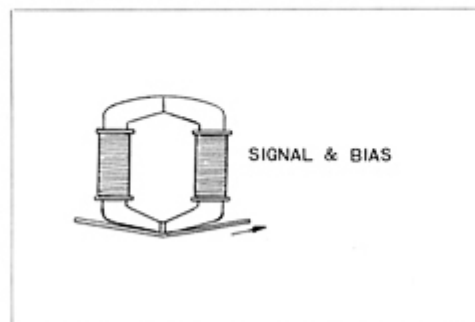
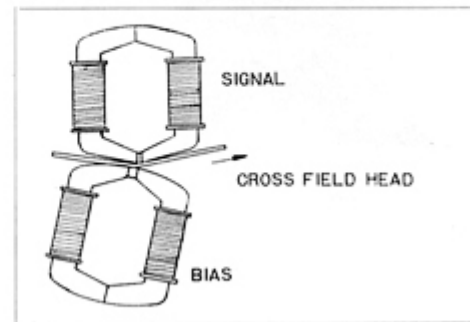

Diagram 2. Cross-field recording system



4. RECORDING/PLAYBACK FOR 4-TRACK

AKAI M-9

The Model M-9 employs the 4-track system, either stereo or monaural.

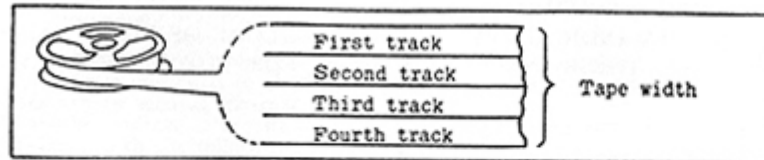

Track selection is made by the TRACK SELECTOR KNOB ⑥.

(A) Recording/Playback for 4-Track Stereo

For stereophonic recording two of these tracks are used at a time. Set the TRACK SELECTOR KNOB ⑥ in "ST" position. The first half of stereophonic recording/playback is made on Tracks No. 1 and 3 and the second half on Tracks No. 2 and 4 after the tape reels have been turned over.

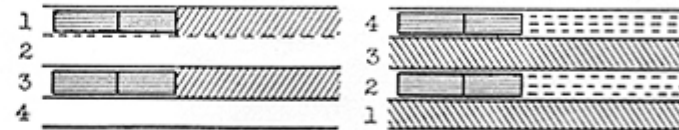

(B) Recording/Playback for 4-Track Monaural

Recording/Playback of monaural should be performed in the sequence of 1-4-3-2 (tracks).

- (1) Monaural recording/playback on tracks No. 1-4

Set the TRACK SELECTOR KNOB ⑥ to "1-4" for recording on track No. 1 first, and then on track No. 4 after the tape reels have been turned over.

- (2) Monaural recording/playback on tracks No. 3-2

Set the TRACK SELECTOR KNOB ⑥ to "3-2" for recording on track No. 3 first, and then on track No. 2 after the tape reels have been turned over.

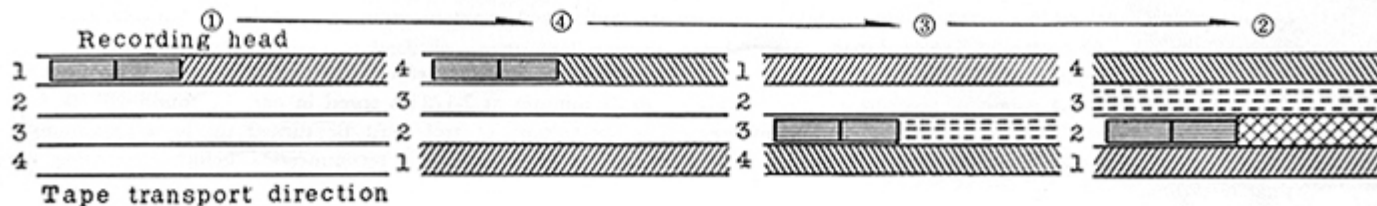

5. OPERATIONAL PRECAUTIONS

IMPORTANT: READ THE FOLLOWING INSTRUCTIONS CAREFULLY BEFORE OPERATING YOUR MACHINE:

- ① THE USE OF A NEW TAPE WILL RESULT IN THE BEST RECORDINGS.
- ② THE SYMPTOMS LISTED BELOW DO NOT NECESSARILY INDICATE MECHANICAL FAILURE OF YOUR TAPE RECORDER. IF YOUR MACHINE EXHIBITS ANY OF THESE SYMPTOMS, CHECK FOR THE TROUBLE AS INDICATED.
 - (1) Loss of sensitivity and tone quality may be due to:
 - A. Dirty erase head. This will prevent prerecorded material from being completely erased.
 - B. Dust on the recording head. Clean the head gently with a soft cotton swab soaked in rubbing alcohol or carbon tetrachloride.
 - C. A.C. power voltage lower than the standard voltage to which your machine is adjusted.
 - (2) Irregularity in the tape transport may be due to:
 - A. Grime adhering to the heads.
 - B. Oil on the capstan.
 - C. Sticky or dirty tape surface.
 - D. Bent take-up reel.
 - (3) If your machine will not record, check the following for correct position.
 - A. Record/Playback knob.
 - B. Input plugs.

Note:

- (1) Before operating your machine, be sure to clean the surface of the head.
- (2) Unused tape may become soft and sticky. It is advisable to run the tape once from the supply reel to the take-up reel before threading it for recording.
- ③ THE FOLLOWING NOTES ARE PROVIDED FOR YOUR CONVENIENCE.
 - (A) If any trouble develops, please take your machine to the nearest authorized agent in your area or inquire at the Service Dept. of the Akai Company in Tokyo, Japan.
 - (B) Your Akai Tape Recorder Model M-9 requires the constant voltage for optimum performance.
 - (C) The standard 1,200 feet length of tape on a 7" reel plays up to 32 minutes at 7-1/2 ips speed in one direction.
 - (D) If the sound sources are so far away from the microphones that the volume control must be turned up to a maximum, some hum or noise will inevitably be recorded. In such instance, a test recording is recommended before attempting a final recording.

6. VOLTAGE AND CYCLE CONVERSION

AKAI M-9

POWER VOLTAGE ADJUSTMENT

The Model M-9 is operatable anywhere in the world. With the built-in stepdown power transformer, the user can easily readjust the recorder to any one of the six stages of power voltage from 100 to 240 volts A.C. Generally, the recorder's input voltage is preset for the forwarding territory.

The user is requested to check the previously set voltage before operation. This can be seen at the rear of the recorder.

If another voltage is required, readjusting of the voltage can be made in accordance with the following instructions.

- (1) Take off the ventilator panel by removing four mounting screws as shown in Fig. A. Then, pull out the VOLTAGE CONVERSION SWITCH ② gently and reset the knob so that the desired voltage will appear on the ventilator panel. (See Fig. B)
- (2) The voltage conversion switch is a plug-in type movable in six steps, 100/110/120/200/220/240. For example, if the power voltage distributed in your area is 220 volts A.C., reset the switch to 220 mark.
- (3) Change fuse according to voltage.

Fuse: 100V~120V 2A, 200V~240V 1A

CAUTION: Disconnect the power plug from the AC outlet before readjusting power voltage. To maintain optimum performance and to prolong the life of your machine, it is important that the line voltage be held within 10 percent deviations from the standard voltage.

POWER CYCLE CHANGE

Correct tape speed is not obtainable if the CYCLE CONVERSION SWITCHES are not properly adjusted. The CYCLE CONVERSION SWITCH (A) ② is located at the center of the deck top panel and the CYCLE CONVERSION SWITCH (B) ③ at the rear of the recorder. Using a screw driver, rotate the CYCLE CONVERSION SWITCH (A) ② counter clockwise approximately one-eighth of a turn. The switch can then be moved either OUT or IN. 50 cycle operation is obtained by moving the switch OUT (Fig. C), and 60 cycle operation, by the switch IN (Fig. D). The switch ② should be rotated back to its original position after it has been moved either OUT or IN. The CYCLE CONVERSION SWITCH (B) ③ should also be reset.

CAUTION: Do not attempt to rotate the CYCLE CONVERSION SWITCHES when the motor is not running.

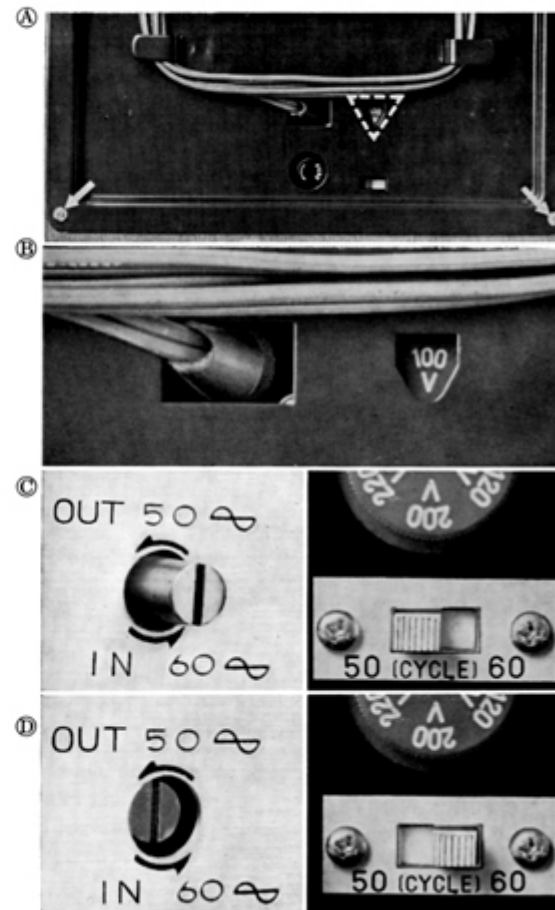

7. SELECTION OF TAPE SPEEDS

Tape Speed Inches per Second	Position of Speed Change Switch		Capstan	
	Slow	Fast	Yes	No
1-7/8	○			○
3-3/4	○		○	
7-1/2		○	○	
15		○	●	

RECORDING TIME

4-Track Stereo			
Tape Length	Tape Speed		
	1-7/8	3-3/4	7-1/2
1200 ft	4 hrs	2	1
1800	6	3	1.5
2400	8	4	2
4-Track Mono			
1200	8	4	2
1800	12	6	3
2400	16	8	4

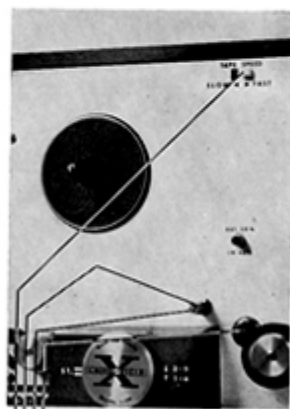

CAPSTAN SHAFT
 CAPSTAN
 CAPSTAN STORAGE POST
 SPEED CHANGE SWITCH

The M-9 operates on 4 tape speeds, 15, 7-1/2, 3-3/4 and 1-7/8 ips.

Refer to the chart above for selecting an adequate tape speed. Tape speed is determined by the motor speed and by the capstan on the tape drive capstan shaft.

- 1-7/8 ips. This tape speed is obtained by setting the SPEED CHANGE SWITCH Ⓞ in "SLOW" position. The capstan is not used but is left on the storage post.
- 3-3/4 ips. This tape speed is obtained by setting the SPEED CHANGE SWITCH Ⓞ also in "SLOW" position. The capstan is mounted on the capstan shaft and is locked automatically in position by the notches.
- 7-1/2 ips. This tape speed is obtained by setting the SPEED CHANGE SWITCH Ⓞ in "FAST" position. The capstan is used.
- 15 ips. This tape speed is provided for convenience. The SPEED CHANGE SWITCH Ⓞ is set at "FAST" and use of an accessory 15 ips. capstan is required, which is indicated in the chart by the double circle. Also replace the pinch wheel with the smaller one.

8. PLAYBACK USING EXTERNAL SPEAKERS

Though your M-9 has two internal speakers, a pair of high fidelity external speakers will enable you to enjoy the best sound reproduction.

- (A) Set the RECORDING MODE SWITCH ②⑤ to "NORM".
- (B) Insert the plugs from the external speakers into the LEFT and RIGHT EXTERNAL SPEAKER JACKS ④⑨ and ④⑩). The external speakers should be separated by at least seven feet. When the speaker plugs are in the speaker jacks, the respective internal speakers are inoperative.

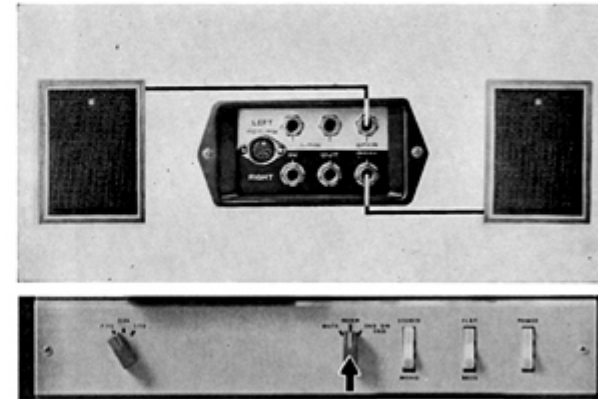

9. DIN (ONE MULTIPLE-CONNECTION) JACK

The DIN JACK ④ is provided on the left side of the M-9 for interconnecting the recorder with an external stereo amplifier that has the same connection jack. This system will permit easy recording and playback of stereophonic programs through an external stereo amplifier as the complexity of connecting or disconnecting more than 4 separate plugs from the recorder's panel side is not needed.

If your amplifier is not equipped with the DIN jack, DIN plug: four separate RCA plugs cord (AKAI DR-110) is usable.

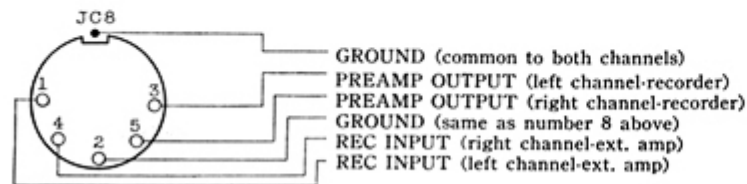

← Front View of DIN Jack

AKAI M-9

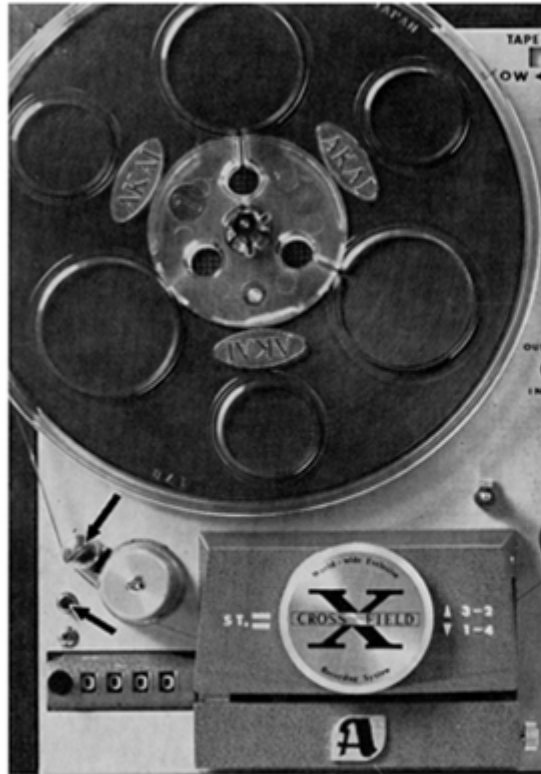

10. TAPE CLEANER

A squeaking noise may annoy the operator while recording or playback. This may be caused either by a poor tape or by ambient conditions of temperature and humidity. When a foreign material adheres to the recording tape, this material piles up at the recording head, affecting volume or quality of sound.

The M-9 is provided with a TAPE CLEANER ④, a felt pad properly soaked in silicon oil to eliminate noise. When wishing to clean the tape, CLEANER BUTTON ⑥ should be depressed. When not needed, the TAPE CLEANER ④ should be turned clockwise and locked. When the felt pad is contaminated and it does not work well for cleaning of the tape, loosen the upper screw and turn the felt pad to the unused side. When both surfaces of the pad are contaminated, the pad should be replaced with a new one. Upon replacing, one or two drops of silicon oil (included) should be placed on the felt for absorption.

Note: When an excessive amount of silicon oil is applied, the tape surface may become discolored and sticky.

I OPERATING INSTRUCTIONS AKAI M-9

1. THREADING THE TAPE

Place your recording tape on the SUPPLY REEL SHAFT ① and the empty reel on the TAKE-UP REEL SHAFT ②.

Thread the tape as illustrated by the dotted line.

To keep the reels from falling down, lock the reels with the retainers provided on the top of the REEL SHAFTS.

IMPORTANT:

If automatic shut-off and automatic stop are required, thread the tape through the AUTOMATIC SHUT-OFF LEVER ③. If not, pass the tape directly onto the take-up reel.

2. STEREO PLAYBACK

Connect the recorder to AC power source using the attached AC CORD.

- (A) Set the POWER SWITCH ④ to "POWER".
 - (B) Set the TRACK SELECTOR KNOB ⑤ to "ST".
 - (C) Select the tape speed.
 - (D) Set the EQUALIZER KNOB ⑥ to 7-1/2, 3-3/4 or 1-7/8, whichever is consistent with tape speed.
 - (E) Set the FUNCTION SWITCH ⑦ to "STEREO".
 - (F) Set the RECORDING MODE SWITCH ⑧ to "NORM".
Setting to "MUTE", you will not hear any sound using internal speakers and external speakers.
- Now, put your pre-recorded tape on the recorder.
- (G) After the above operation, set the RECORD/PLAYBACK KNOB ⑨ to "PLAY".

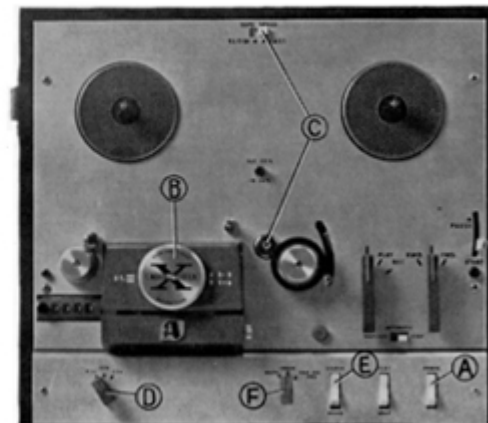
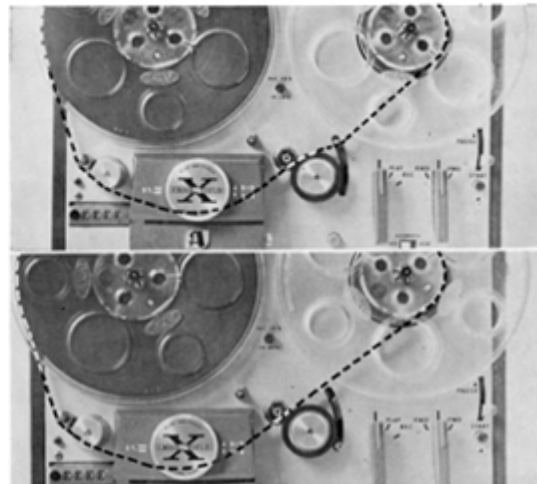

AKAI M-9

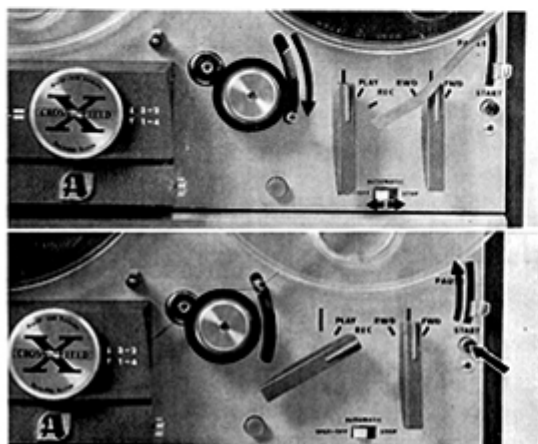

STEREO PLAYBACK

- (H) Adjust the LEFT and RIGHT VOLUME CONTROL KNOBS (16) and (20) to desired volume.
- (I) Also adjust to desired tone by using the TREBLE CONTROL KNOBS (17) and (19), and the BASS SWITCH (27).
If you would like to stress treble sound, turn the knobs (17) and (19) clockwise, and if bass sound, set the switch (27) to "BASS".

3. AUTOMATIC STOP/AUTOMATIC SHUT-OFF

One of the exclusive features of the M-9 is the automatic shut-off function of the units. Whenever the tape comes to the end, or is damaged by accident, the AUTOMATIC SHUT-OFF LEVER (25) drops down. Setting the AUTOMATIC STOP/SHUT-OFF SWITCH (26) to "STOP", only the motion of the tapes stops, and if to "SHUT-OFF", all the functions of both deck and amplifier are automatically cut off.

In these cases, just when the AUTOMATIC SHUT-OFF LEVER (25) drops down, PINCH WHEEL (28) releases from the CAPSTAN (27) automatically in order to prevent deformation of its soft rubber surface. This function is AUTOMATIC PINCH WHEEL RELEASE.

4. INSTANT STOP CONTROL

To stop the tape momentarily on recording or playback, push the INSTANT STOP LEVER (24) as shown in the Figure. The lever will be locked in the stop position, and it can be released by pushing the START BUTTON (23). The INSTANT STOP LEVER (24) will not function when the recorder is in either fast forward or rewind operation.

An optimum recording level can be determined before starting the recording by using the INSTANT STOP LEVER (24) after the recorder is set in a normal recording mode of operation. Adjust the volume control while watching the VU METERS (21) and (22).

5. STEREO RECORDING

- (A) Set the POWER SWITCH (28) to "POWER".
- (B) Set the TRACK SELECTOR KNOB (9) to "ST".
- (C) Select the tape speed as desired.
- (D) Set the EQUALIZER KNOB (12) to 7-1/2, 3-3/4 or 1-7/8, whichever is consistent with tape speed.
- (E) Set the FUNCTION SWITCH (26) to "STEREO".
- (F) Set the RECORDING MODE SWITCH (25) to "MUTE" or "NORM".
- (G) Push the RESET BUTTON (7) and set the INDEX COUNTER (8) to "0000". This counter provides reference numbers for locating specific points of the recordings on the tape.

Insert the MICROPHONE PLUGS into the MICROPHONE JACKS (14) and (15).

Keep the two microphones at least 7 feet apart. Place the recording tape on the recorder and push the INSTANT STOP LEVER (24) upward until it locks. Then, turn the RECORD/PLAYBACK KNOB (21) into "REC." position while depressing the RECORD SAFETY BUTTON (23).

Microphone volume level may be adjusted and balanced by the RECORDING LEVEL CONTROL KNOBS (13 and 15). Normal recording should not exceed the black zone on VU METERS (21 and 22).

After an optimum recording level is determined, push the START BUTTON (28) and release the INSTANT STOP LEVER (24) to start stereo recording.

IMPORTANT:

When you are recording, you can monitor sound either from your stereo headphone or from the internal speakers (or the external speakers) if set the RECORDING MODE SWITCH (25) to "NORM". But if set it to "MUTE", you can monitor only by your stereo headphone.

AKAI M-9

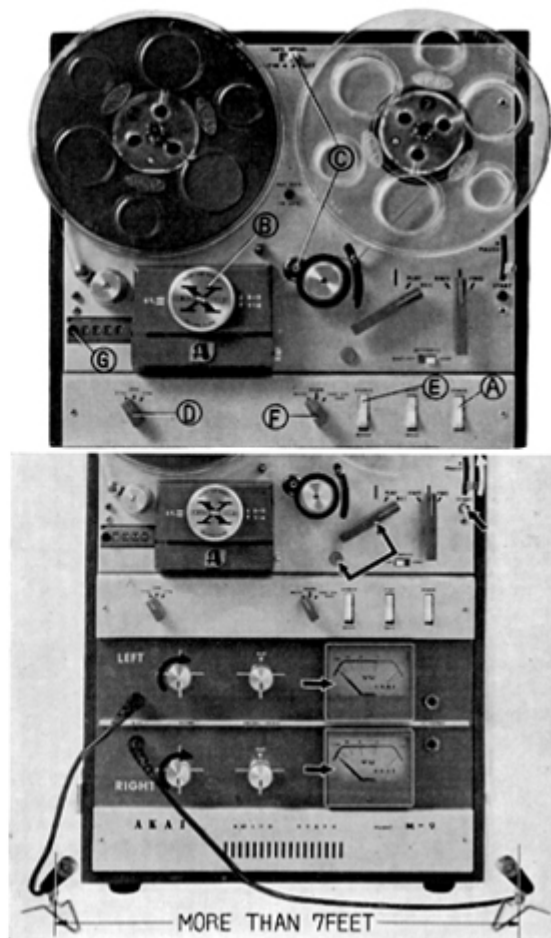

14

AKAI M-9

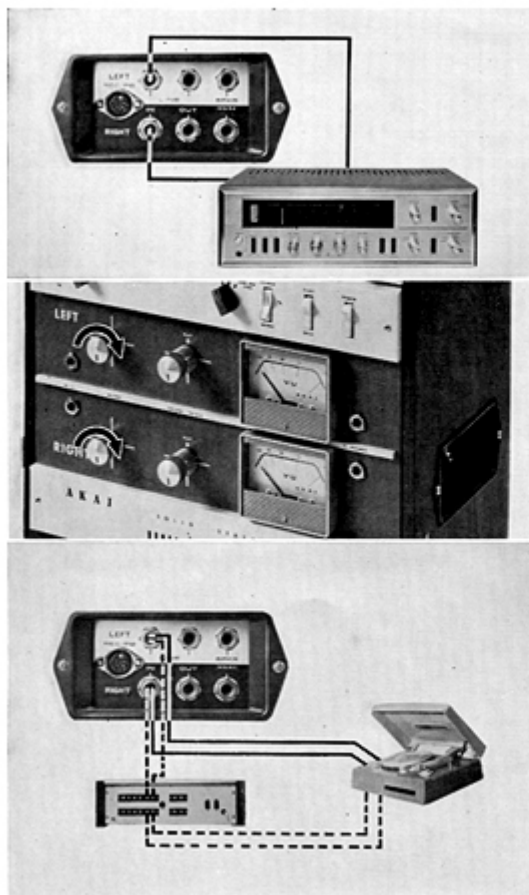

6. RECORDING FROM STEREO BROADCAST

Stereophonic broadcast programs may be recorded from two sets of radio receivers. This is accomplished by connecting LINE INPUT JACK (LEFT) ⑬ of Model M-9 to the voice coil terminals of the left-hand speaker and LINE INPUT JACK (RIGHT) ⑭ to similar terminals of the right-hand speaker of the respective radio set. Recording level is adjusted by RECORDING LEVEL CONTROL KNOBS (⑬ and ⑭).

7. RECORDING FROM STEREO DISCS

To record from a stereo disc, a crystal pickup or ceramic pickup can be connected direct to the LINE INPUT JACKS (⑬ and ⑭). Magnetic cartridge output should be connected to a separate preamplifier and then to the LINE INPUT JACKS (⑬ and ⑭).

8. MONAURAL RECORDING ON TRACKS NO. 1-4

- Ⓐ Set the POWER SWITCH ⑳ to "POWER".
- Ⓑ Set the TRACK SELECTOR KNOB ⑨ to "1-4".
- Ⓒ Select the tape speed as desired.
- Ⓓ Set the EQUALIZER KNOB ⑫ to 7-1/2, 3-3/4 or 1-7/8, whichever is consistent with tape speed.
- Ⓔ Set the FUNCTION SWITCH ㉔ to "MONO".
- Ⓕ Set the RECORDING MODE SWITCH ㉕ to "MUTE" or "NORM".
- Ⓖ Push the RESET BUTTON ⑦ and set the INDEX COUNTER ⑧ to "0000".

MONAURAL RECORDING ON TRACKS NO. 1-4

In monaural recording, only the left channel amplifier is used. The right channel amplifier is not required for this operation.

So the microphone plug should be inserted into the MICROPHONE JACK (LEFT) ⑭.

Place the recording tape on the recorder.

Push the INSTANT STOP LEVER ⑳ upward until it locks, and then turn the RECORD/PLAYBACK KNOB ㉑ into "REC" position while depressing the RECORD SAFETY BUTTON ㉒. Adjust the RECORDING LEVEL CONTROL KNOB (LEFT) ⑬ to normal recording level, while watching the VU meter indicator of the left channel amplifier. VU meter reading should not exceed the black zone.

After a correct recording level is determined, push the START BUTTON ㉓ to start recording on track No. 1.

At the end of recording on track No. 1, reverse both tape reels for the next recording on track No. 4.

9. MONAURAL RECORDING ON TRACKS NO. 3-2

Set the TRACK SELECTOR KNOB ⑨ to "3-2". For the rest of operation, just follow the instructions given for tracks No. 1-4 recording. Recording is made first on track No. 3, then on track No. 2 with both reels reversed.

To record from a disc player or an external amplifier monaurally, use the LINE INPUT JACK (LEFT) ④. A crystal pickup can be connected directly to the LINE INPUT JACK (LEFT) ④. When recording from an external amplifier, connect to the LINE INPUT JACK (LEFT) ④ from the TAPE OUTPUT of an external amplifier.

To record from a radio, connect radio cable to the radio speaker or to the earphone jack. The cable plug should be inserted into LINE INPUT JACK (LEFT) ④.

AKAI M-9

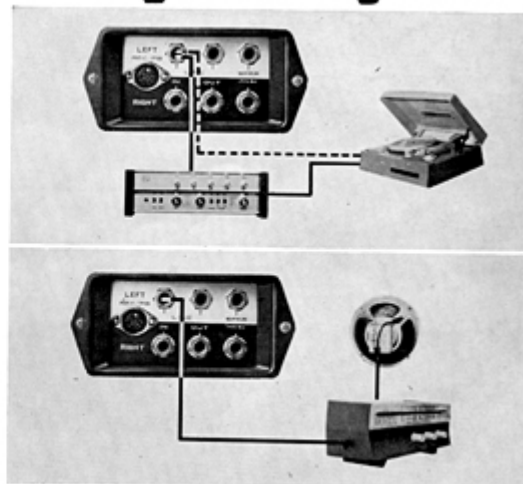

AKAI M-9

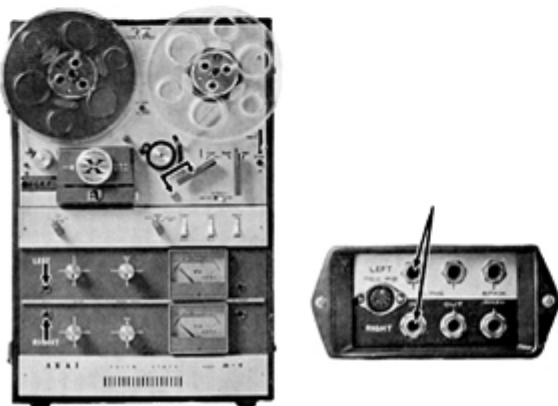
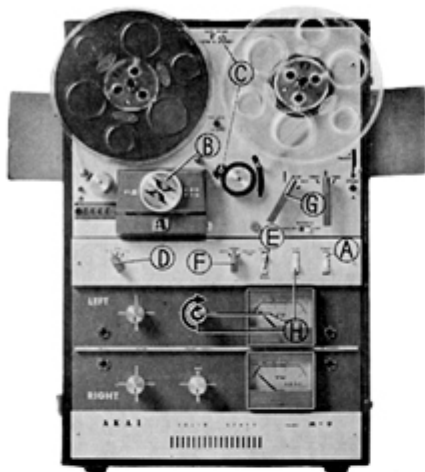

10. MONAURAL PLAYBACK

- Ⓐ Set the POWER SWITCH ⑳ to "POWER".
- Ⓑ Set the TRACK SELECTOR KNOB ⑨ to "1-4".
- Ⓒ Select the tape speed as desired.
- Ⓓ Set the EQUALIZER KNOB ⑫ to 7-1/2, 3-3/4 or 1-7/8, whichever is consistent with tape speed.
- Ⓕ Set the FUNCTION SWITCH ⑳ to "MONO".
Place the pre-recorded tape on the tape recorder.
On monaural playback, only the left channel amplifier should be used.
- Ⓖ Set the RECORDING MODE SWITCH ㉔ to "NORM".
- Ⓖ Set the RECORD/PLAYBACK KNOB ㉑ to "PLAY".
- Ⓗ Adjust volume by the VOLUME CONTROL KNOB (LEFT) ⑮ and tone by the TREBLE CONTROL KNOB (LEFT) ⑰ and the BASS SWITCH ㉕.

After completing monaural playback on track No. 1 and No. 4, set the TRACK SELECTOR KNOB ⑨ to "3-2" for starting now with track No. 3, then track No. 2.

11. TAPE ERASING

Any signal information previously recorded on a tape will be erased automatically as a new recording is made on the same tape. Thread the tape, and place in normal record position. There should be no plugs connected to recorder's input jacks. The RECORDING LEVEL CONTROL KNOBS (⑬ and ⑭) should be held in "0" position. A BULK TAPE ERASER is recommended for quick and complete erasure.

12. FAST FORWARD AND REWIND

Fast forward or rewind is accomplished by turning the FAST FORWARD/REWIND KNOB ㉔ into the proper position. When the tape has been completely wound up or cut, The Automatic Shut-off Lever ㉕ drops down and then the FAST FORWARD/REWIND KNOB ㉔ is automatically returned and motion of the tape stops.



13. MONITORING

Monitoring is made by connecting the stereo headphone to the STEREO HEADPHONE JACKS ㉖ or ㉗.

On monaural as well as stereo recording, please use the stereo headphone. Caution: The stereo headphone should be of a low impedance type (8 ohms). If you record setting the RECORDING MODE SWITCH ㉘ to "NORM", you can monitor from the internal (or external) speakers, too.

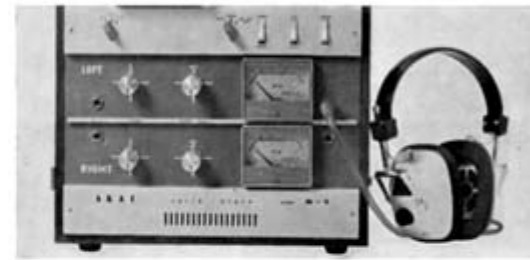

14. TAPE SPLICING AND EDITING

Superimpose the tapes and cut them diagonally as illustrated. (This diagonal cutting eliminates the "click" or "pop" sound of the splice.) Register the cut ends and apply a splicing tape on the glossy side of the record tape.

Press the splice tape with fingers firmly to secure the ends evenly. Trim off excess splicing tape. Preferably, cut the recording tape slightly along its edge as illustrated by the dotted lines. This eliminates the possibility of a sticky splice. Tape splicing using scissors requires skillful work. The scissors should not be magnetized. But, our specially designed portable splicer can do the job with ease.

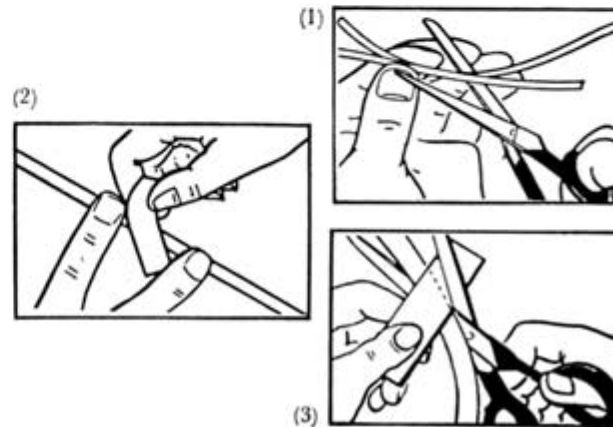
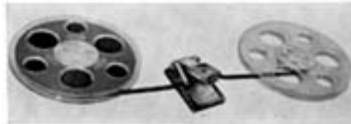

15. CLEANING HEAD

TAPE OXIDE DEPOSITS ARE 90% OF THE CAUSES OF YOUR TAPE RECORDING FAILURES.

It is imperative for quality performance of a tape recorder to keep the heads neat and clean at all times. Dust and magnetic particles from the tape tend to deposit on the heads after prolonged use of the tape recorder. This would result in poor head-to-tape contact, deteriorating the sound quality and sensitivity. Such dust would cause a significant drop in recording, playback and erase quality levels.

EXAMPLE



CLEAN HEAD

Frequency response curve

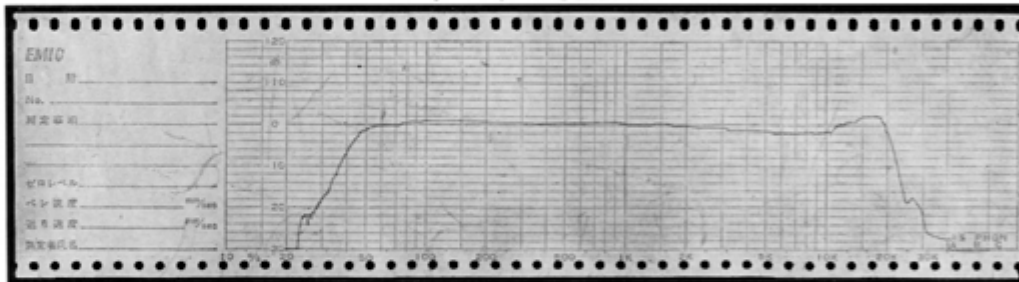

DUSTY HEAD

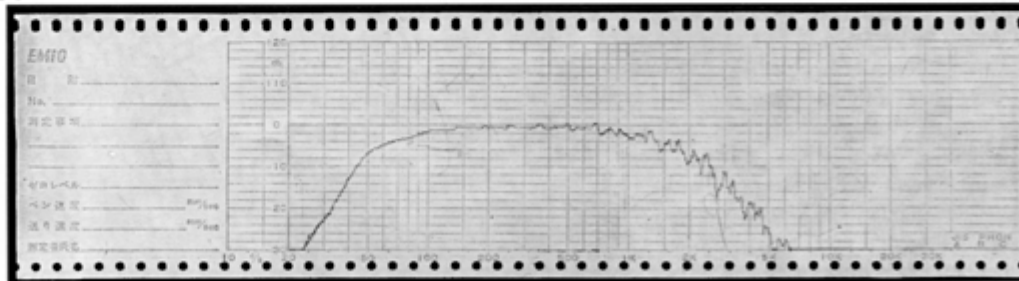

CLEANING HEAD

AKAI M-9

Make it a rule to clean the heads every time you use your tape recorder. AKAI's Head Cleaning Kit (Accessory No. HC-500) is recommended for removing the foreign matters deposited on the heads. If this kit is not available, use alcohol.



AKAI M-9



16. HEAD DEMAGNETIZATION

Normally, the steel pole pieces which form a part of the recording and playback heads become slightly magnetized. The effect of the slight head magnetization is to partially erase the tape. Mostly high frequencies suffer. Generally, slightly magnetized heads can be detected by noticing loss of normal high frequency response which cannot be corrected through head alignment. Severe magnetization which may result if magnetized tools are used in the vicinity of the heads, will result in noise or considerable distortion in addition to the loss of high frequency response. Although the M-9 already has a built-in Head Demagnetizing circuit, it is recommended that head demagnetization be performed periodically.

After removing the head cover, head demagnetization can be accomplished by touching the head lightly with the demagnetizer and making several small circular motions over all head surface areas as well as the head housing.

17. TAPE DUPLICATION

Connecting AKAI X-355 Tape Recorder with M-9.

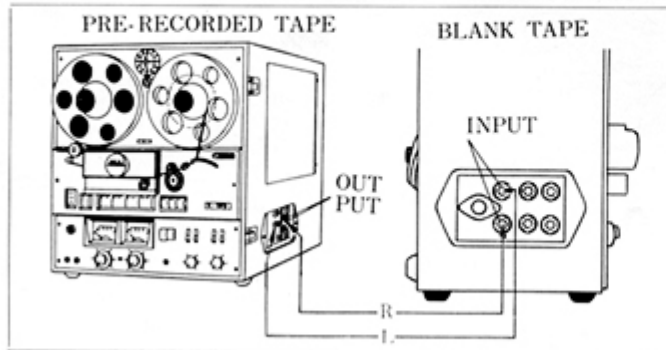

Connecting M-9 with another M-9.

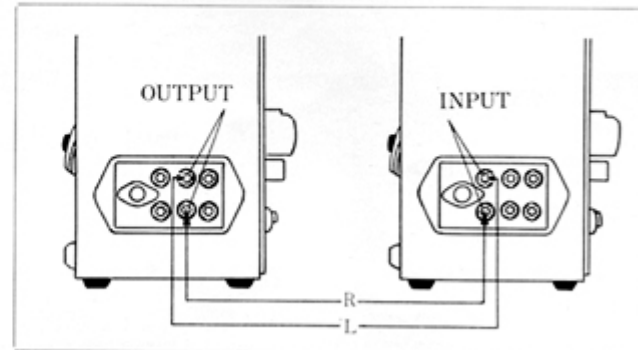

18. SOUND ON SOUND

AKAI M-9

USE OF SOUND ON SOUND

With the Model M-9 recording of sound on sound can be easily made. A wide application of sound on sound recording includes (for instance) the study of a foreign language, a trick recording, a duet by one person, or a quartet of musical instruments.

The case of singing a song in duet style by one person is taken up (for instance).

- (1) Place the tape on the recorder and set the tape counter to "0000". Record the soprano on the first track with the proper recording level. (Follow the rest of the monaural "1-4" track recording)

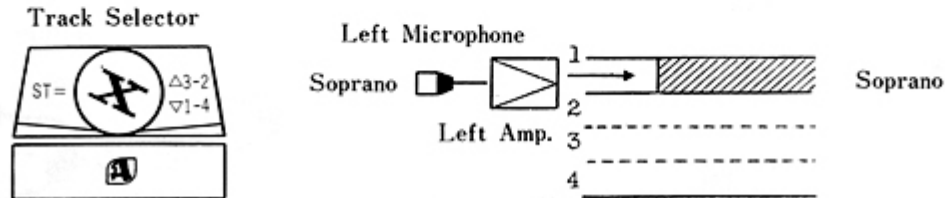

- (2) After recording, rewind the recorded portion, turn the TRACK SELECTOR KNOB to position "3-2", and set the RECORDING MODE SWITCH ⊗ to "SND ON SND". And set the FUNCTION SWITCH ⊗ to "STEREO". In this case, connect the stereo headphone to the STEREO HEADPHONE JACK ⊗ or ⊗ . Finishing these steps, record the alto, on track 3 monitoring the pre-recorded soprano on track 1, with the stereo headphone.

The soprano is reproduced by the right channel amplifier (electrically connected with left channel amplifier), mixed with the alto input from the microphone, and recorded on track 3.

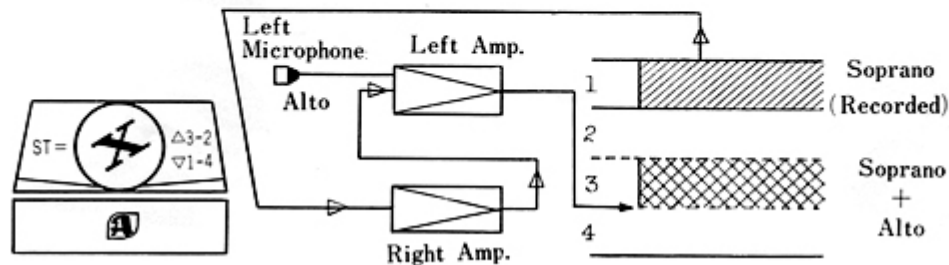

AKAI M-9

SOUND ON SOUND

The second alto recording is adjusted with the VOLUME CONTROL KNOB (LEFT) ⑩, watching the left VU meter ⑪. The level of the right VU meter ⑫ indicates the first soprano recording.

- (3) After completing the second recording, this portion should be rewound. Then the third track is played and a duet of soprano and alto can be heard.

When the first track is played, the soprano, alone can be enjoyed. In the same manner, when the first and the third tracks are interchangeably selected (by the track selector), such recording of sound on sound can be made repeatedly, thus one can enjoy recording of even quartet or sextet singing.

19. TRANSISTOR PROTECTION

The S. E. P. P. O. T. L. system is used to protect the output circuitry of the M-9, main amplifiers. The output impedance should be 8 ohms. If a speaker of less than 8 ohms impedance is used or if the speaker terminals are accidentally shorted, the protector fuse will blow to protect the transistors. Transistors are easily damaged by excessive load or high ambient temperatures. If the protector fuse has blown, the sound may be distorted or there may be no sound at all. The protector fuse may be replaced with special 1.0A fuse.

1. ACCESSORIES OPTIONAL

Condenser Microphones



No. CM-15

Dynamic Microphones



No. DM-13

Tape Splicer



No. AS-3

Head Demagnetizer



No. AH-6

III ACCESSORIES AKAI M-9

Telephone Pick-up



No. AP-2

Tape Eraser



No. ATE-7

Stereo Headphone



No. ASE-9S

Head Cleaning Kit



No. HC-500

AKAI M-9

ACCESSORIES OPTIONAL

AKAI Magnetic Tape & Tape Reel



AKAI Magnetic Tape
 AT-5S (600 feet)
 AT-7S (1,200 feet)
 AT-10S (2,400 feet)
 AT-5L (900 feet)
 AT-7L (1,800 feet)
 AT-10L (3,600 feet)



AKAI Tape Reel
 ATR-5 (for 5")
 ATR-7 (for 7")

Akai Connecting Cords

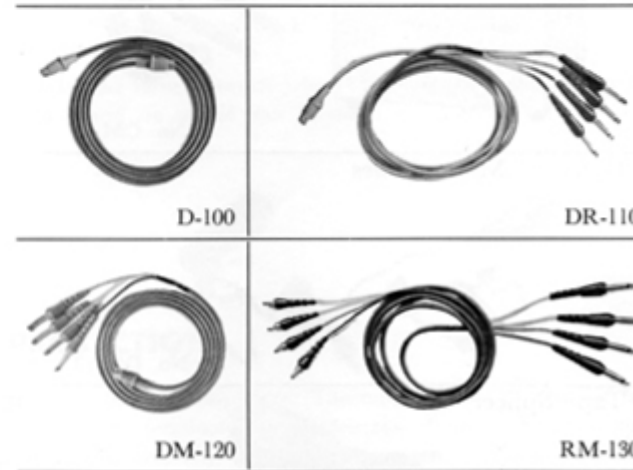

2. ACCESSORIES STANDARD

7" Demonstration Tape	1	Spare Fuse for main Amp.....	2
7" Empty Reel	1	Silicon Oil	1
15ips Adaptor Kit.....	1	Felt Pad	2
Spare Fuse for Voltage	2	Operator's Manual	1