

For the best performance.....

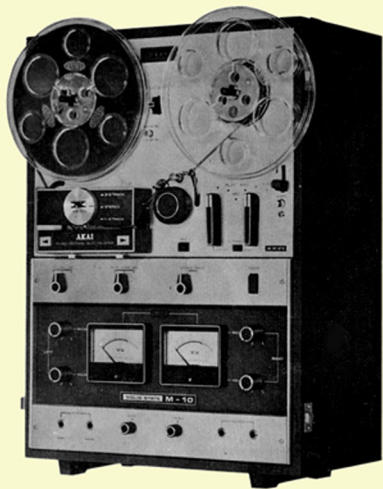

AKAI M-10

**THREE MOTORS
AUTO. REVERSE
STEREO TAPE RECORDER**

TABLE OF CONTENTS

I GENERAL INFORMATION

1. Specifications	1
2. Controls	2
3. Voltage and Cycle Conversion.....	4
4. Tape Speed Selection.....	5
5. 4-Track Recording/Playback System.....	5
6. Cross-Field Head	6
7. DIN (One Multiple-Connection) Jack.....	7
8. Automatic Stop/Shut-off	7
9. Operating Precautions	8

II OPERATING INSTRUCTIONS

1. Tape Loading	9
2. Instant Stop/Pause Control	9
3. Fast Forward and Rewind	9
4. Playback	10
Stereo	
Monaural	
Using External Speakers	
5. Automatic Reverse (Metallic Sensing Tape)	11
6. Manual Reverse	12
7. Recording	13
Stereo	
Monaural	
From an External Amplifier	
From Another Tape Recorder	
From Discs	
Sound on Sound	
8. Monitoring	17
9. Tape Splicing and Editing	17
10. Tape Erasing	17
11. Head Cleaning	18
12. Head Demagnetizing	19

III ACCESSORIES

1. Optional Accessories	20
2. Standard Accessories	21

I. GENERAL INFORMATION

1. SPECIFICATIONS

Tape Speed	: 1-7/8, 3-3/4 and 7-1/2 ips
Wow and Flutter	: Less than 0.08% RMS at 7-1/2 ips Less than 0.12% RMS at 3-3/4 ips Less than 0.20% RMS at 1-7/8 ips
Frequency Response	: 30 to 26,000 Hz ± 3 db at 7-1/2 ips 30 to 19,000 Hz ± 3 db at 3-3/4 ips 30 to 9,000 Hz ± 3 db at 1-7/8 ips
Signal to Noise Ratio	: Better than 50 db
Input Level	: Mic more than 0.5 mV Line more than 50 mV DIN more than 5 mV (LOW) more than 50 mV (HIGH)
Power Output	: 15 W maximum each channel at UNDISTORTED POWER, total 30 W 20 W maximum each channel at MUSIC POWER, total 40 W
Equalization	: Correct equalization for playback of tapes recorded to the NAB curve.
Recording Bias Frequency	: 100 KHz
Recording Level Indicator	: 2 VU meters
Recording System	: 4-track stereo/monaural, CROSS-FIELD bias system
Fast Forward and Rewind Time	: 75 seconds using 1,200 foot tape at 50 Hz. 60 seconds at 60 Hz.
Recording Capacity	: 8 hours monaural recording at 1-7/8 ips (1,200 foot tape). 4 hours stereo recording at 1-7/8 ips
Maximum Reel Size	: 7" reel
Head	: 3 heads... Erase, record/playback and bias heads
Motor	: 3 motors... Hysteresis synchronous 3-speed motor for capstan drive. Two out-rotor motors for supply and take-up reel drive
Speaker	: 2 4" x 6" speakers
Transistor	: 22 transistors
IC	: 2 IC
Power Supply	: AC 100 to 240 V, 50/60 Hz
Power Consumption	: 165 W
Dimensions	: 18-3/4" x 13-3/4" x 9-1/2" (474 x 350 x 242 mm)
Weight	: 48.4 lbs (22 kg)

2. CONTROLS

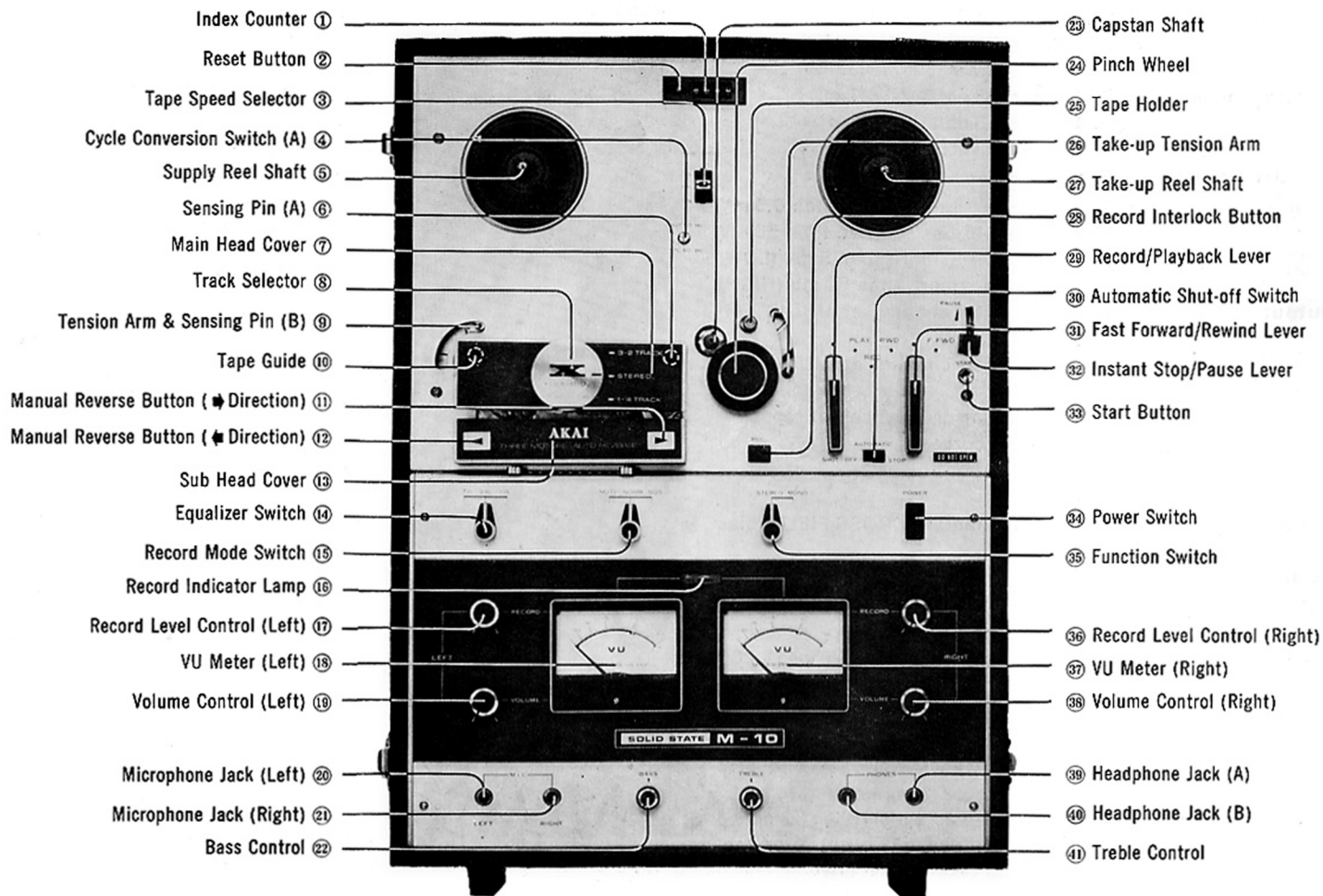

Fig. 1



Fig. 2

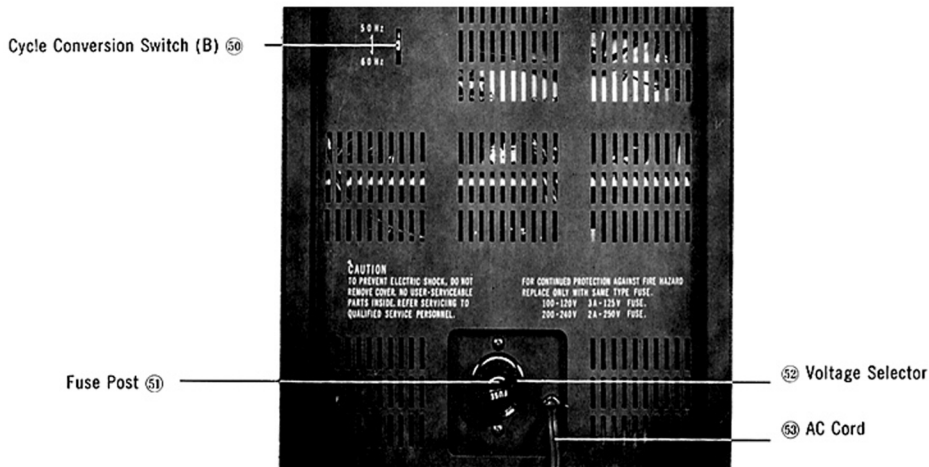

Fig. 3

3.VOLTAGE AND CYCLE CONVERSION

VOLTAGE

The Model M-10 is operable anywhere in the world. With the built-in step-down power transformer, the operator can easily readjust the recorder to any one of the six stages of power voltage from 100 to 240 volts A.C. The operator is requested to check the rear of the recorder to determine the previously set voltage before operation.

If another voltage is required, readjustment of the voltage can be made as follows.

- (1) Remove the FUSE POST as shown in Fig. 4. Remove the PLUG of VOLTAGE SELECTOR and reinsert so that the desired voltage appears.
- (2) The VOLTAGE SELECTOR as shown in Figs. 5, 6 and 7 is a rotatable plug-in type offering six selections, 100/110/120/200/220/240.
- (3) Change the fuse according to voltage.

Fuse: 100V-120V 3A, 200V-240V 2A

CAUTION: Disconnect power plug from the AC outlet before readjusting voltage. To maintain optimum performance and to prolong the life of your machine, it is important that the line voltage be held within 10 percent deviation of standard voltage.

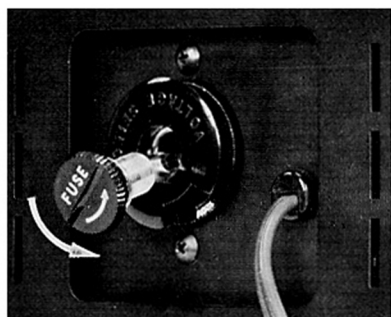

Fig. 4



Fig. 5



Fig. 6

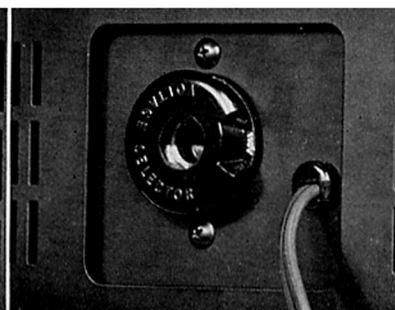

Fig. 7

CYCLE

Correct tape speed cannot be obtained if the Cycle Conversion Switches are not properly positioned. The CYCLE CONVERSION SWITCH (A) is located in the upper center of the top face panel and the CYCLE CONVERSION SWITCH (B) is located in the rear of the recorder. Using a screw driver, rotate the CYCLE CONVERSION SWITCH (A) counter clockwise approximately one-eighth of a turn. The switch can then be moved either OUT or IN. 50 cycle operation is obtained by moving the switch OUT (Fig. 8), and 60 cycle operation by moving the switch IN (Fig. 9). The switch should be rotated back to its original position after it has been moved either OUT or IN. The CYCLE CONVERSION SWITCH (B) should also be reset.

CAUTION: Do not attempt to rotate the CYCLE CONVERSION SWITCHES when the motor is not running.

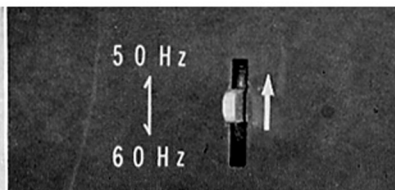

Fig. 8

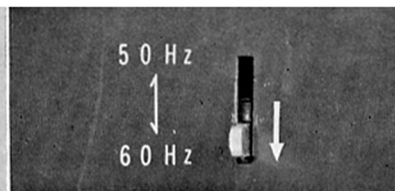
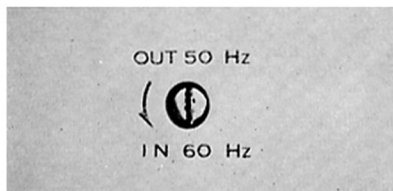

Fig. 9

4. TAPE SPEED SELECTION

The M-10 operates on 3 tape speeds, 7-1/2, 3-3/4 and 1-7/8 ips.

Refer to the chart for selection of an adequate tape speed.

- * 1-7/8 ipsThe 1-7/8 ips tape speed is obtained by setting the TAPE SPEED SELECTOR to "1-7/8".
- * 3-3/4 ipsThe 3-3/4 ips tape speed is obtained by setting the TAPE SPEED SELECTOR to "3-3/4".
- * 7-1/2 ipsThe 7-1/2 ips tape speed is obtained by setting the TAPE SPEED SELECTOR to "7-1/2".

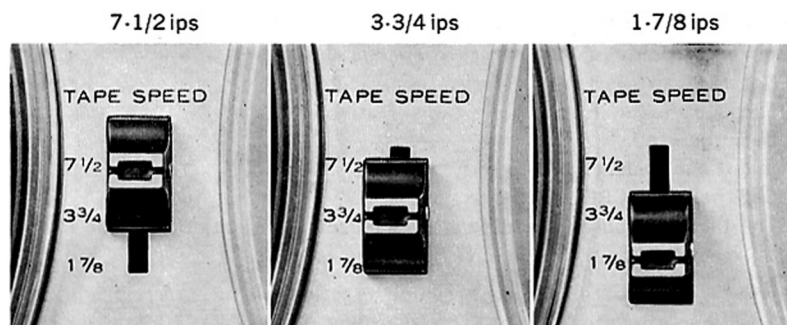

Fig. 10

RECORDING TIME

TAPE LENGTH	4-TRACK STEREO			4-TRACK MONO		
	TAPE SPEED			TAPE SPEED		
	1-7/8 ips	3-3/4	7-1/2	1-7/8	3-3/4	7-1/2
1200 ft	4 hrs	2	1	8	4	2
1800	6	3	1.5	12	6	3
2400	8	4	2	16	8	4

5. 4-TRACK RECORDING/PLAYBACK SYSTEM

The AKAI M-10 employs a four track system which can be used for either stereo or monaural recording/playback. The desired track or tracks are selected by the TRACK SELECTOR.

4-TRACK STEREO RECORDING/PLAYBACK

Stereo recording/playback requires the simultaneous use of two tracks.

Set the TRACK SELECTOR to "STEREO".

The first stereo recording/playback occurs on tracks 1 and 3, and the second on tracks 2 and 4 after the reels have been inverted.



Fig. 11

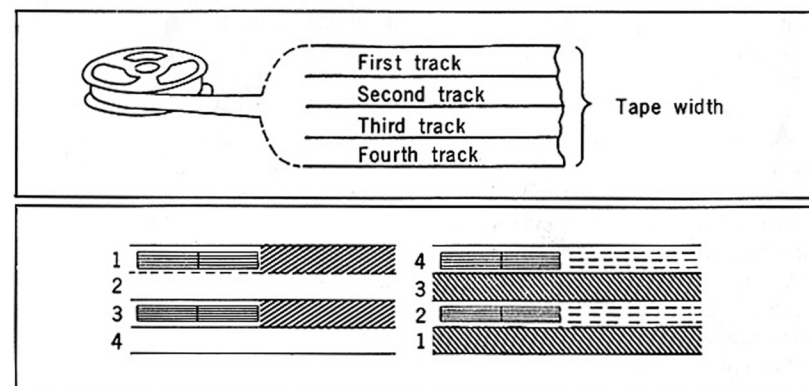

4-TRACK MONAURAL RECORDING/PLAYBACK

Monaural recording/playback track sequence should be 1-4-3-2.

(A) Set the TRACK SELECTOR to "1-4". The first monaural recording/playback occurs on track 1, and the second on track 4 after the reels have been inverted.

(B) Invert the reels.

(C) Set the TRACK SELECTOR to "3-2".

The third monaural recording/playback occurs on track 3, and the fourth on track 2 after the reels have been inverted.

The M-10 does not record in the reverse direction. Using reverse playback, it is not necessary to turn the tape reels over. When the M-10 begins reverse playback, the record/playback head is automatically shifted to the remaining tracks.

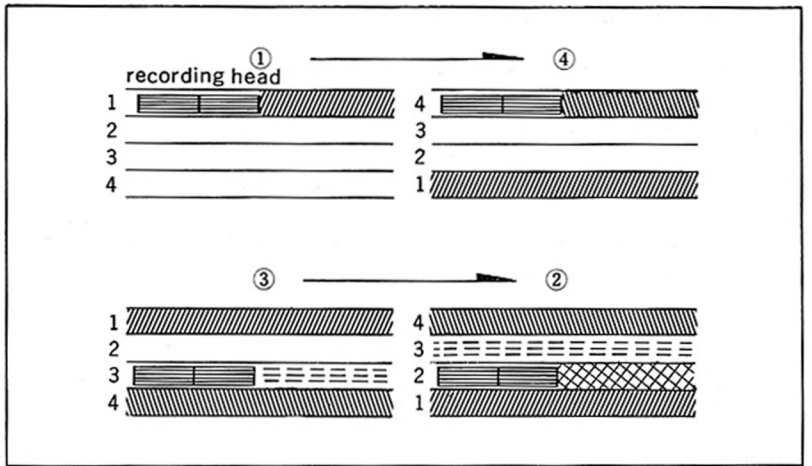

6. CROSS-FIELD HEAD

AKAI's exclusive cross-field head has created a sensation in the tape recorder world by offering a wide recording range which has never been duplicated. Using this cross-field head, Model M-10 provides a surprising recording performance (30-26,000 Hz \pm 3 db at a tape speed of 7-1/2 ips.)

Why is cross-field recording superior? How does it differ from conventional recording methods?

In the typical recording system, the signal current and the bias current are combined and applied to the recording head. (Diagram 1).

It is well known that the bias current is to minimize distortion while maintaining a proper sensitivity ratio.

However, the bias current providing such an advantage also has an undesirable effect. That is, the wide magnetic field of the bias current affects the recorded signal, resulting in the weakening or even erasing of the signal.

This phenomenon is particularly noticeable at high frequencies. In the cross field system, the signal current is applied to the recording head while the bias current is applied to the bias head.

These two heads are positioned as determined inter-relatively, so that the magnetic field of the bias will not affect the signal recorded on the tape, even when maximum bias is applied. This permits recording with high fidelity even at low speeds.

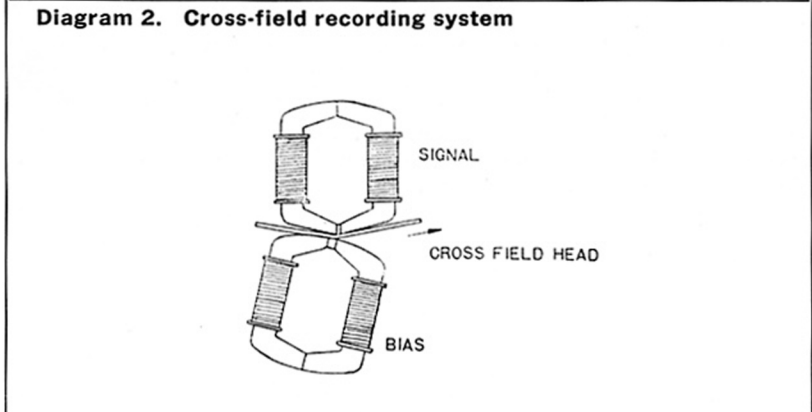
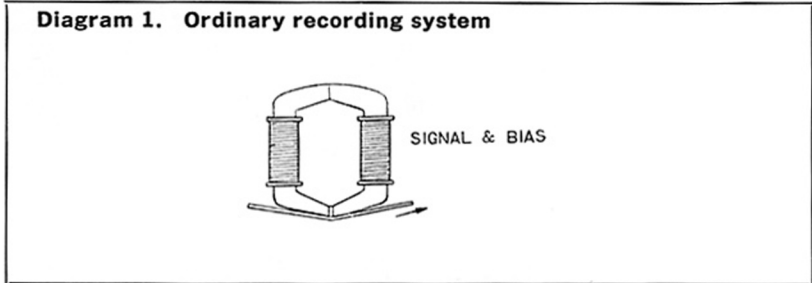

7. DIN (ONE MULTIPLE-CONNECTION) JACK

The DIN JACK which is provided at the left side of Model M-10, and is used for interconnecting Model M-10 with an external stereo amplifier, has a compatible connection jack. This system permits easy recording and playback of stereo programs through an external stereo amplifier. Thus the complex connection or disconnection of more than 4 separate plugs from Model M-10's panel side is avoided.

If your amplifier is not equipped with the DIN jack and the use of this one connection system is required, AKAI DR-110 may be used.

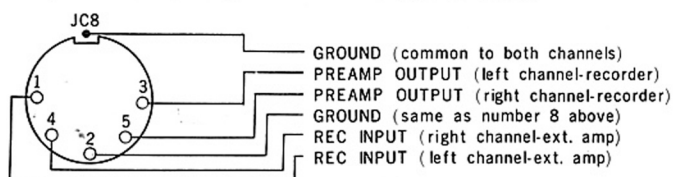

Font View of DIN JACK

NOTE:

When the output level of an external amplifier is more than 50 mV, set the HIGH/LOW INPUT SELECTOR to "HIGH"

But, when output level is more than 5 mV, set it to "LOW".

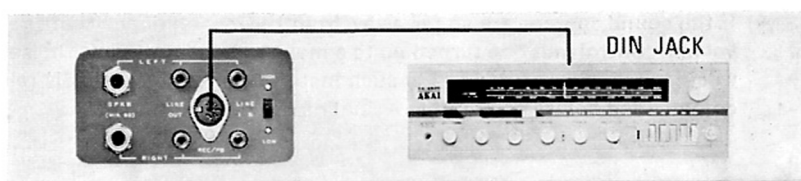

Fig. 12

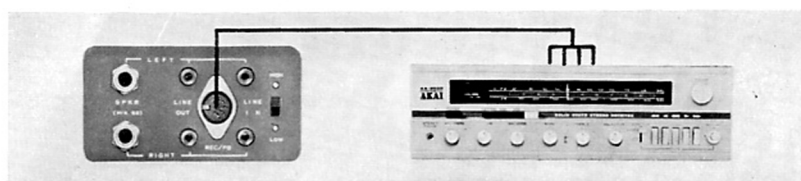

Fig. 13

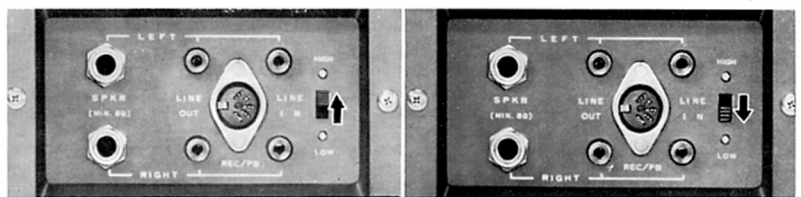

Fig. 14

8. AUTOMATIC STOP/SHUT-OFF

One of the exclusive features of Model M-10 is the function of the automatic shut-off unit. When the tape ends or is accidentally broken the TAKE-UP TENSION ARM drops and reel movement stops. The Automatic Stop serves to stop the deck of the recorder, while the Automatic Shut-off to turn off the deck and amplifier. To obtain automatic shut-off of the recorder the AUTOMATIC SHUT-OFF SWITCH must be placed in the "SHUT-OFF" position.

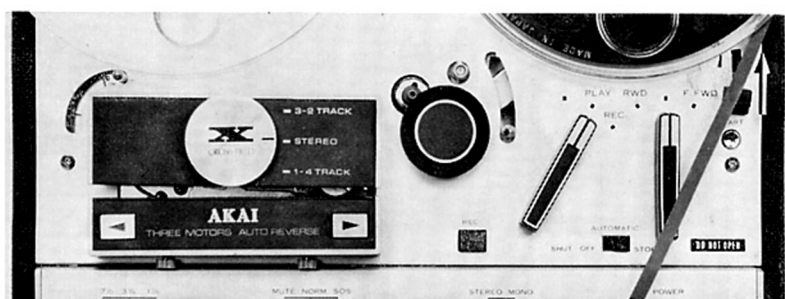

Fig. 15

AUTOMATIC SHUT-OFF

AUTOMATIC STOP

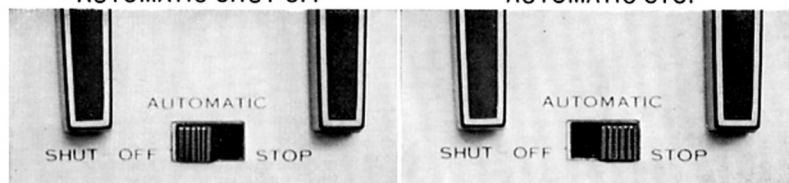

Fig. 16

9. OPERATING PRECAUTIONS

IMPORTANT : READ THE FOLLOWING INSTRUCTIONS CAREFULLY BEFORE OPERATING YOUR MACHINE :

- ① THE USE OF NEW TAPE WILL RESULT IN THE BEST RECORDINGS.
- ② THE SYMPTOMS LISTED BELOW DO NOT NECESSARILY INDICATE MECHANICAL FAILURE OF YOUR TAPE RECORDER. IF YOUR MACHINE EXHIBITS ANY OF THESE SYMPTOMS, CHECK FOR THE TROUBLE AS INDICATED.

(1) Loss of sensitivity and tone quality may be due to :

- A. Dirty erase head. This will prevent prerecorded material from being completely erased.
- B. Dust on the recording head. Clean the head gently with a soft cotton swab soaked in rubbing alcohol or carbon tetrachloride.
- C. A.C. power voltage lower than the standard voltage to which your machine is adjusted.

(2) Irregularity in the tape transport may be due to :

- A. Grime adhering to the heads.
- B. Oil on the capstan.
- C. Sticky or dirty tape surface.
- D. Bent take-up reel.

(3) If your machine will not record, check the following for correct position.

- A. Record/Playback lever.
- B. Input plugs.

NOTE :

- (1) Before operating your machine, be sure to clean the surface of the head.
- (2) Unused tape may become soft and sticky. It is advisable to run the tape once from the supply reel to the take-up reel before threading it for recording.

③ THE FOLLOWING NOTES ARE PROVIDED FOR YOUR CONVENIENCE.

- (1) If any trouble develops, please take your machine to the nearest authorized agent in your area or inquire at the Service Dept. of the Akai Company in Tokyo, Japan.
- (2) Your Akai Model M-10 requires constant voltage for optimum performance.
- (3) The standard 1.200 foot length of tape on a 7" reel plays up to 32 minutes at 7-1/2 ips speed in one direction.
- (4) If the sound sources are so far away from the microphones that the volume control must be turned up to a maximum, some hum or noise will inevitably be recorded. In such instance, a test recording is recommended before attempting a final recording.

II . OPERATING INSTRUCTION

1. TAPE LOADING

Place the full reel of tape on the SUPPLY REEL SHAFT and the empty reel on the TAKE-UP REEL SHAFT.

Thread the tape as illustrated by the dotted line.

To keep the reels from failing, lock the reels with the retainers provided on the top of the REEL SHAFTS.

IMPORTANT :

If the automatic shut-off and automatic stop are required, thread the tape below the TAKE-UP TENSION ARM. If not, pass the tape directly onto the take-up reel. But, in the case, reverse operation does not occur.

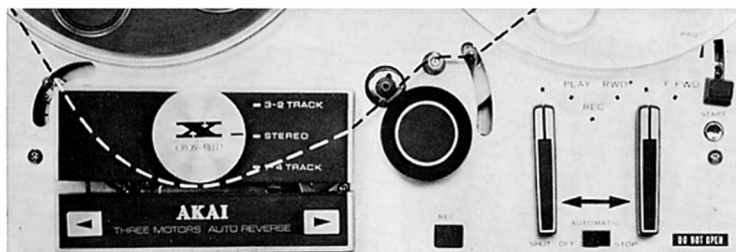

Fig. 17



Fig. 18

2. INSTANT STOP/PAUSE CONTROL

To momentarily stop the tape during record/playback push the INSTANT STOP/PAUSE LEVER to the "PAUSE" position as shown Fig. 19.

The lever will be locked in the stop position and can be released by pushing the START BUTTON. The INSTANT STOP/PAUSE LEVER will not function during fast forward or rewind operating.

Use of the INSTANT STOP/PAUSE LEVER permits adjustment and balance of the optimum recording level when the recorder is set to the normal recording mode. Adjust the record level controls while watching the VU meters.

This control may additionally be used, during recording, to edit the tape (e.g. lift the lever to stop the recorder when certain portions of the program are not desired). It is noted that when the the lever is released by pushing the START BUTTON and recording again commences, no annoying switch "click" is impressed on the tape.



Fig.19

3. FAST FORWARD AND REWIND

Fast forward or rewind is performed by turning the FAST FORWARD/REWIND LEVER to the proper position. Fast forward or rewind permits rapid selection of recordings on the tape. The FAST FORWARD/REWIND LEVER cannot be turned out of the stop position unless the RECORD/PLAYBACK LEVER is in its stop position, and vice-versa.

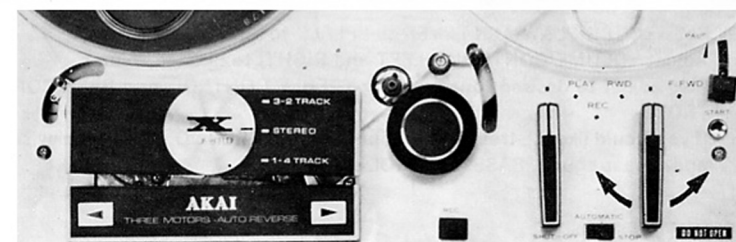

Fig. 20

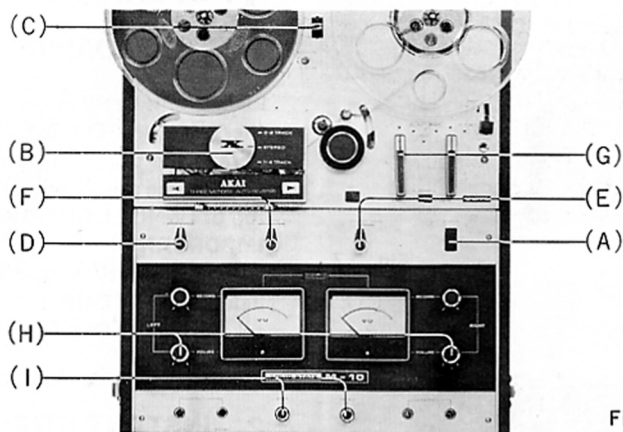

Fig. 21

4. PLAYBACK

STEREO

Connect the recorder to AC power source with the attached AC CORD and load the tape.

- (A) Push POWER SWITCH.
- (B) Set TRACK SELECTOR to "STEREO".
- (C) Select the desired tape speed by TAPE SPEED SELECTOR.
- (D) Set EQUALIZER SWITCH to 7-1/2, 3-3/4 or 1-7/8 ips, whichever is consistent with tape speed.
- (E) Set FUNCTION SWITCH to "STEREO".
- (F) Set RECORD MODE SWITCH to "NORM".
Setting to "MUTE", you will not hear any sound using internal speakers and external speakers.
- (G) Set RECORD/PLAYBACK LEVER to "PLAY" to start playback.
- (H) Adjust VOLUME CONTROLS (LEFT and RIGHT) to desired volume.
- (I) Also adjust to desired tone by using TREBLE CONTROL, and BASS CONTROL.

If you would like to stress treble sound, turn TREBLE CONTROL clockwise, and if bass sound, BASS CONTROL clockwise.

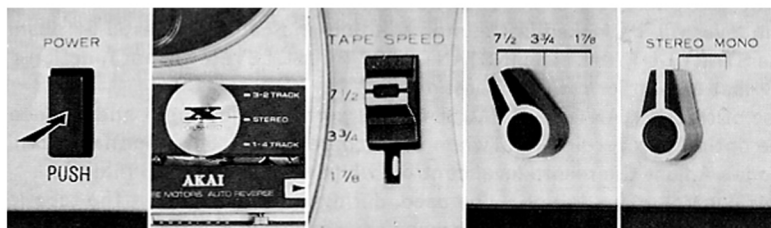

(A)

(B)

(C)

(D)

(E)

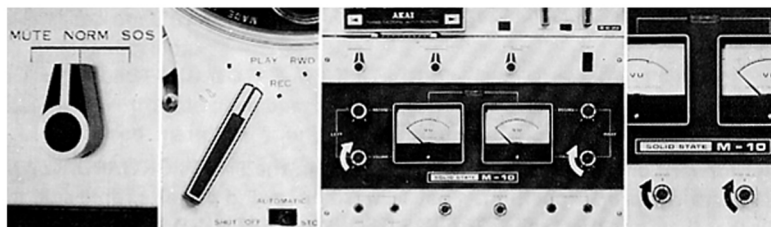

(F)

(G)

(H)

(I)

MONAURAL

For monaural playback, substitute the following steps (B), (E) and (H) of the stereo procedure, and add step (J). Follow the rest of the stereo procedure.

Playback on tracks 1 and 4

Only the left channel amplifier is used for monaural playback on tracks 1 and 4.

(B) Set TRACK SELECTOR to "1-4".

(E) Set FUNCTION SWITCH to "MONO".

(H) Adjust VOLUME CONTROL (LEFT) to desired volume.

(J) Invert the reel to playback on track 4.

Playback on tracks 3 and 2

Only the left channel amplifier is used for monaural playback on tracks 3 and 2.

(B) Set TRACK SELECTOR to "3-2".

(E) Set FUNCTION SWITCH to "MONO".

(H) Adjust VOLUME CONTROL (LEFT) to desired volume.

(J) Invert the reel to playback on track 2.

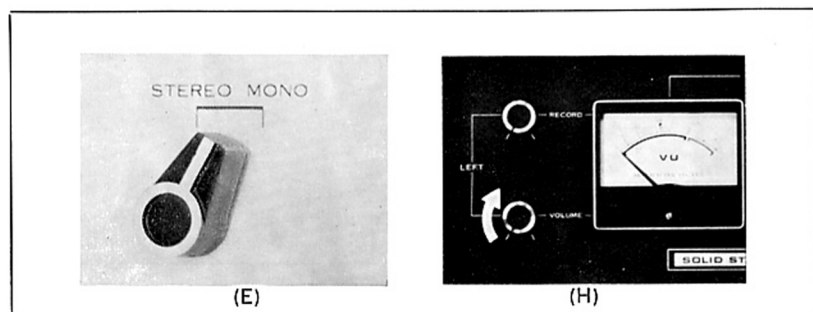
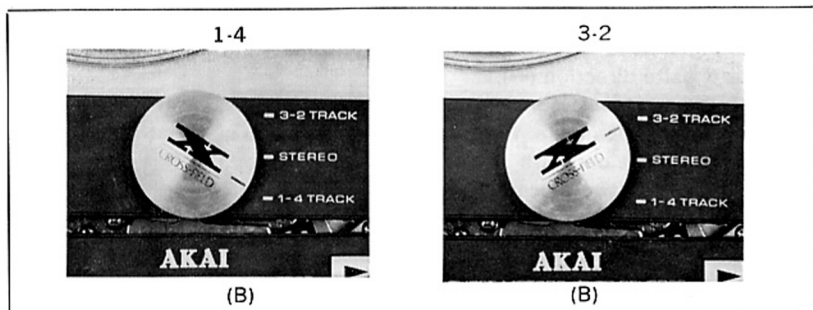

USING EXTERNAL SPEAKERS

Though your AKAI M-10 has two internal speakers, a pair of high fidelity external speakers will enable you to enjoy the best sound reproduction.

(A) Set RECORD MODE SWITCH to "NORM".

(B) Insert the plugs from the external speakers into LEFT and RIGHT EXTERNAL SPEAKER JACKS.

The external speakers should be separated by at least seven feet. When the speaker plugs are in the speaker Jacks, the respective internal speakers are inoperative.

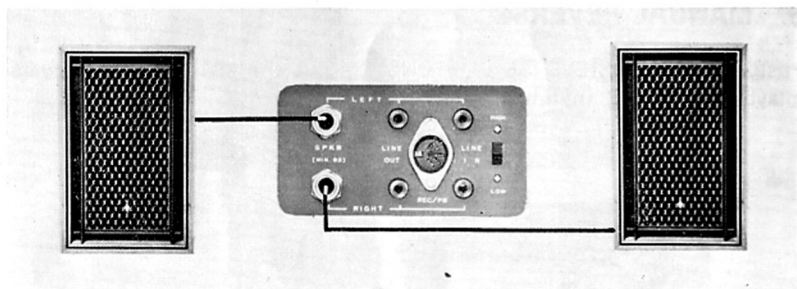

Fig.22

5. AUTOMATIC REVERSE (METALLIC SENSING TAPE)

Automatic reverse with metallic sensing tape is used for playback only.

(A) Cut sensing tape approximately 1/2 inches.

(B) Put this sensing tape at the desired reverse point of the tape in use.

Reversal will occur when the metallic sensing tape makes contact with SENSING PIN.

- (C) If you put sensing tape at the desired reverse point A on shiny side of the tape in use, the tape direction (\Rightarrow) will automatically reverse and play in the opposite direction (\Leftarrow).
- (D) If you put metallic sensing tape at the desired reverse point B on dull side of the tape in use, the tape direction (\Leftarrow) will automatically reverse and play in the opposite direction (\Rightarrow).
- (E) So, if you put two pieces of metallic sensing tape at the desired points A and B simultaneously, the M-10 will give continuous playback in both direction between A and B.

NOTE : If the sensing tape is dirty, the proper reverse operation of the tape will not be made.

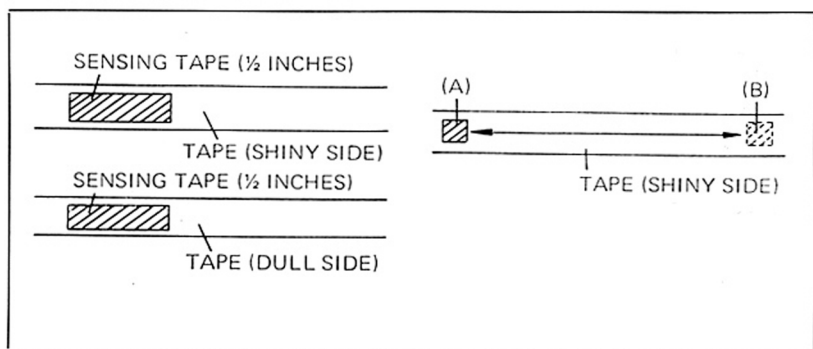
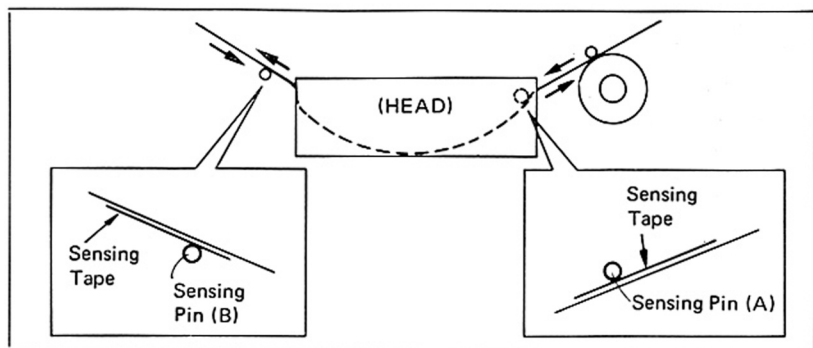

6. MANUAL REVERSE

Pushing **MANUAL REVERSE BUTTONS** will put the M-10 into the reverse (playback) function anytime.



Fig. 23

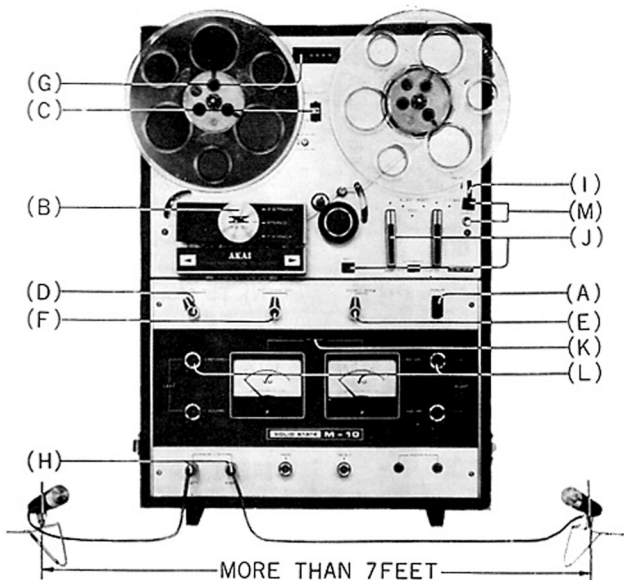
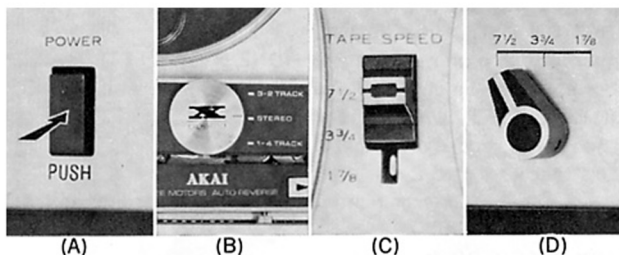

Fig. 24

7. RECORDING

STEREO

- (A) Push POWER SWITCH.
- (B) Set TRACK SELECTOR to "STEREO".
- (C) Select the desired tape speed by TAPE SPEED SELECTOR.
- (D) Set EQUALIZER SWITCH to 7-1/2, 3-3/4 or 1-7/8 ips, whichever is consistent with tape speed.



- (E) Set FUNCTION SWITCH to "STEREO".
- (F) Set RECORD MODE SWITCH to "MUTE" or "NORM".
If RECORD MODE SWITCH is set to "NORM", you can monitor sound from either your headphones or internal speakers (or external speakers). But if it is set to "MUTE", you can monitor only with headphones.
- (G) Set RESET BUTTON and set INDEX COUNTER to "0000".
This INDEX COUNTER provides a reference for locating any position on the tape.
- (H) Insert microphone plugs into MICROPHONE JACKS (LEFT and RIGHT).
Maintain a distance of at least seven feet between the microphones.

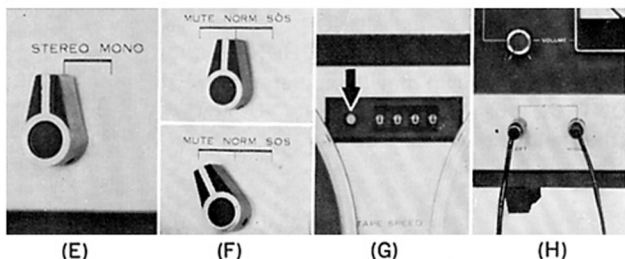

- (I) Push INSTANT STOP/PAUSE LEVER upward until it locks.
- (J) Turn RECORD/PLAYBACK LEVER to "REC" position while depressing RECORD INTERLOCK BUTTON.
- (K) Check RECORD INDICATOR LAMP is on.
If the lamp is not on, the M-10 will not record.
- (L) Microphone volume level may be adjusted and balanced by RECORD LEVEL CONTROLS (LEFT and RIGHT). Normal recording should not exceed the black zone on VU METERS (LEFT and RIGHT).
- (M) After optimum recording level is determined, push START BUTTON and release INSTANT STOP/PAUSE LEVER to start stereo recording.
- (N) To stop recording, return RECORD/PLAYBACK LEVER while depressing RECORD INTERLOCK BUTTON.

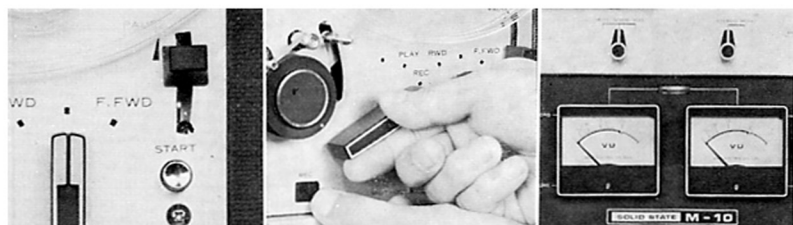

(I)

(J)

(K)

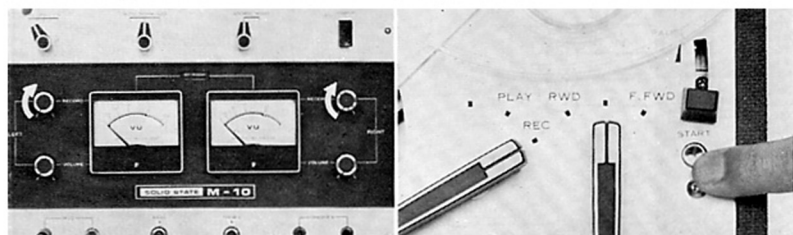

(L)

(M)

MONAURAL

For monaural recording, substitute the following steps (B), (E), (H) and (L) of the stereo procedure, and add step (O). Follow the rest of the stereo procedure.

Recording on tracks 1 and 4

Only the left channel amplifier is used for monaural recording on tracks 1 and 4.

- (B) Set TRACK SELECTOR to "1-4".
- (E) Set FUNCTION SWITCH to "MONO",
- (H) Insert microphone plug into MICROPHONE JACK (LEFT).
- (L) Microphone volume level may be adjusted and balanced by RECORD LEVEL CONTROL (LEFT), while observing VU METER (LEFT).
- (O) Invert the reel to record on track 4.

Recording on tracks 3 and 2

Only the left channel amplifier is used for monaural recording on tracks 3 and 2.

- (B) Set TRACK SELECTOR to "3-2".
- (E) Set FUNCTION SWITCH to "MONO"
- (H) Insert microphone plug into MICROPHONE JACK (LEFT).
- (L) Microphone volume level may be adjusted and balanced by RECORD LEVEL CONTROL (LEFT), while observing VU METER (LEFT).
- (O) Invert the reel to record on track 2.

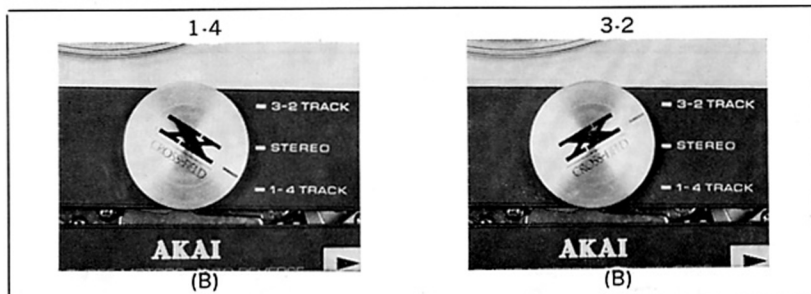

(B)

(B)

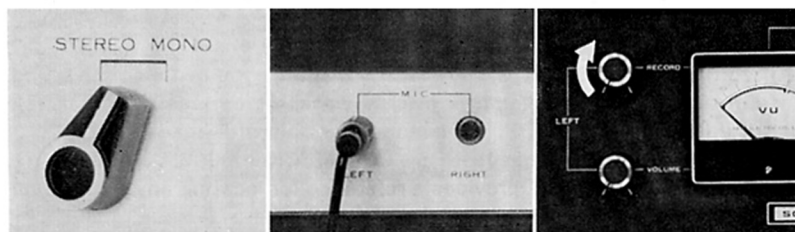

(E)

(H)

(L)

FROM AN EXTERNAL AMPLIFIER

If an external amplifier or tuner-amplifier combination is used, connect TAPE OUTPUT leads of the external amplifier to LINE INPUT JACKS (LEFT and RIGHT) in step (H) of the recording procedure.

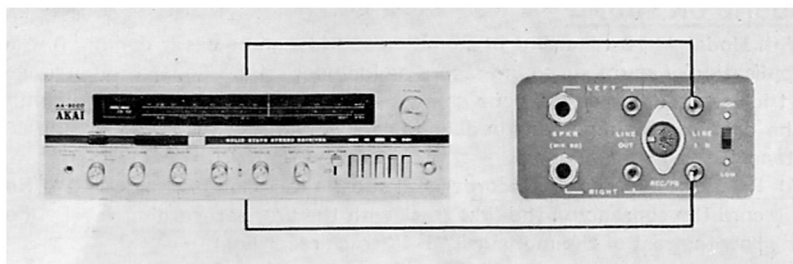

Fig. 25

FROM ANOTHER TAPE RECORDER

Connect LINE OUTPUT JACKS or EXTERNAL SPEAKER JACKS of the playback machine to LINE INPUT JACKS (LEFT and RIGHT) of the record machine in step (H) of the recording procedure.

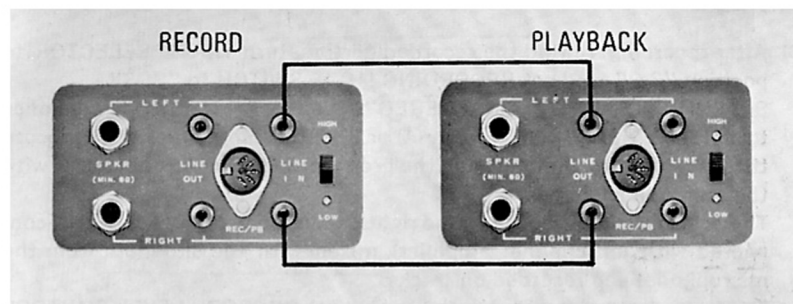

Fig. 26

FROM DISCS

To record from a stereo or monaural disc, a "CRYSTAL PICK UP" or a "CERAMIC PICK UP" can be directly connected to LINE INPUT JACKS (LEFT and RIGHT) in step (H) of the recording procedure. If a "MAGNETIC CARTRIDGE" is used it must be connected to a separate pre-amplifier or external amplifier before being connected to LINE INPUT JACKS (LEFT and RIGHT).

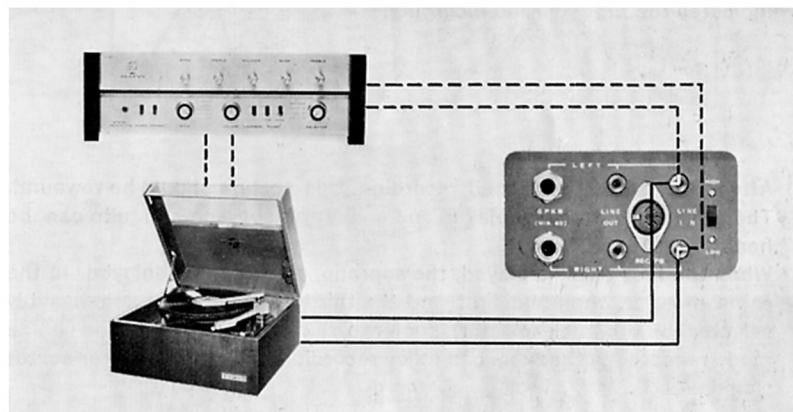
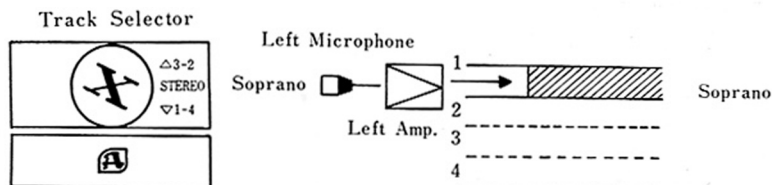

Fig. 27

SOUND ON SOUND

With Model M-10 recording of sound on sound can be easily done. A wide application of sound on sound recording includes study of a foreign language, a trick recording, a duet by one person, or a quartet of musical instruments. The case of singing a song in duet style by one person is taken up (for instance).

- (A) Place the tape on the recorder and set the tape counter to "0000". Record the soprano on the first track with the proper recording level. (Follow the rest of the monaural "1-4" track recording)



- (B) After recording, rewind the recorded portion, turn TRACK SELECTOR to position "3-2", and set RECORDING MODE SWITCH to "SOS".

Set FUNCTION SWITCH to "STEREO". Connect the stereo headphones to STEREO HEADPHONE JACK (A) or (B). Finishing these steps, record the alto, on track 3 monitoring the pre-recorded soprano on track 1, with the stereo headphones.

The soprano is reproduced by the right channel amplifier (electrically connected with left channel amplifier), mixed with the alto input from the microphone, and recorded on track 3.

The second alto recording is adjusted with the RECORD LEVEL CONTROL (LEFT), watching the left VU meter. The level of the right VU meter indicates the first soprano recording.

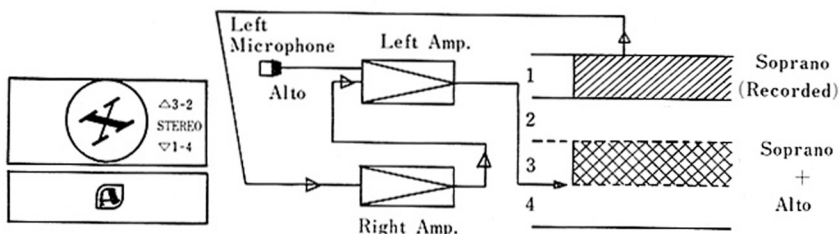

- (C) After completing the second recording, this portion should be rewound. Then the third track is played and a duet of soprano and alto can be heard.

When the first track is played, the soprano, alone can be enjoyed. In the same manner, when the first and the third tracks are interchangeably selected (by the track selector), such recording of sound on sound can be made repeatedly, thus one can enjoy recording of even quartet or sextet singing.



Fig. 28

8. MONITORING

Monitoring is performed by connecting stereo headphones to the STEREO HEADPHONE JACK ((A) or (B)).

On monaural as well as stereo recording, please use stereo headphones.

CAUTION: The stereo headphones should be of low impedance type (8 ohms).

If you can record setting RECORD MODE SWITCH to "NORM", you can monitor from internal (or external) speakers, too.

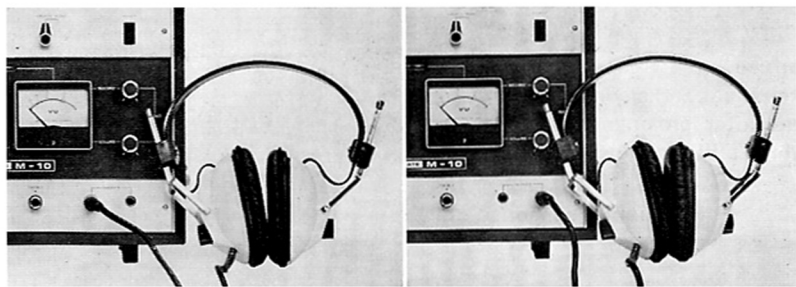

Fig. 29

9. TAPE SPLICING AND EDITING

Superimpose the tapes and cut them diagonally as illustrated in Figures. Cutting on the diagonal eliminates the "click" or "pop" sound in recording/playback.

Match the aligned ends and apply splicing tape to the glossy side.

Firmly press the splice with fingers to secure the ends evenly. Trim off excess splicing tape (cut into the recording tape very slightly as illustrated by the dotted lines—this eliminates the possibility of a sticky splice.) Because tape splicing with scissors is difficult and requires much skill, it is recommended that our specially designed portable splicer be used to ensure professional results.

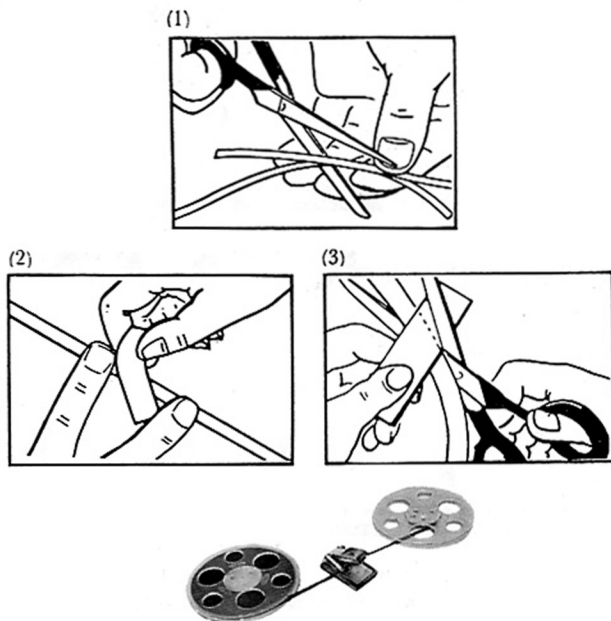

10. TAPE ERASING

Any signal information previously recorded on the tape will be automatically erased before and as the new recording occurs. Load the tape and set the recorder to the normal record position. No plugs should be connected to the LINE INPUT JACKS (LEFT and RIGHT) and the MICROPHONE JACKS (LEFT and RIGHT). A Bulk Tape Eraser should be used for quick and complete erasing.

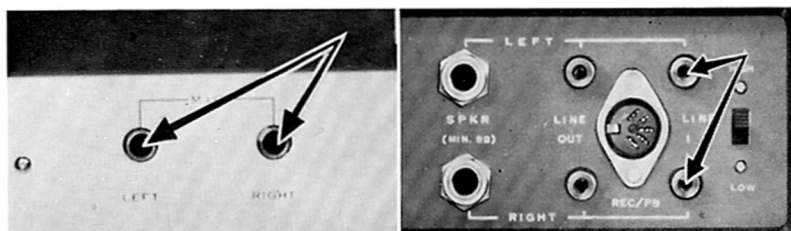

Fig. 30

11. HEAD CLEANING

Tape Oxide/Dust Deposits Cause 90% of Your Tape Recording Failure

For quality performance it is imperative that tape recorder heads be kept neat and clean at all times.

Dust and magnetic particles from the tape tend to deposit on the heads after prolonged use of the recorder.

This results in poor head-to-tape contact deteriorating sound quality and sensitivity.

Worse still such dust causes drastic drops in recording/playback levels and nullifies high quality sound.

EXAMPLE



CLEAN HEAD

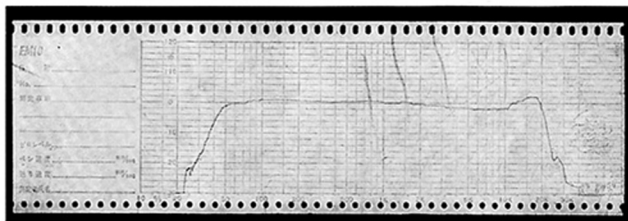

DUSTY HEAD

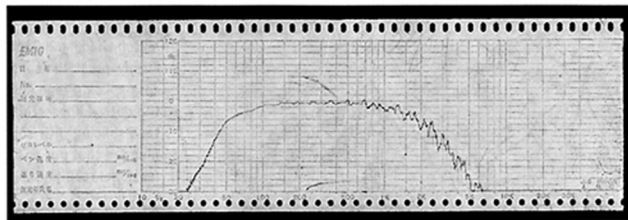

Make it a rule to clean the heads every time you use your tape recorder. AKAI's Head Cleaning Kit (Accessory NO. HC-500) is recommended for removing foreign matter deposited on the heads. If this kit is not available, use alcohol.

NOTE: Clean the heads after setting the RECORD/PLAYBACK LEVER to "PLAY".

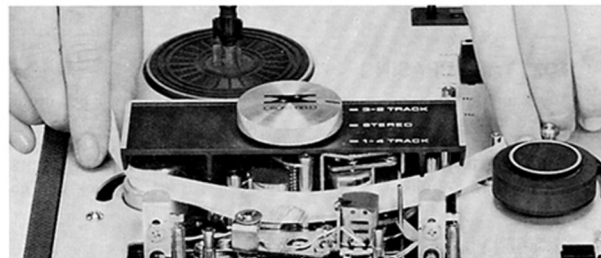

Fig 33

12. HEAD DEMAGNETIZING

Normally the steel pole pieces which form a part of the recording and playback heads become slightly magnetized. The effect of the slight head magnetization is to partially erase the tape. Mostly high frequencies suffer.

Generally, slightly magnetized heads can be detected by noticing loss of normal high frequency response which cannot be corrected through head alignment. Severe magnetization which may result if magnetized tools are used in the vicinity of the heads will result in noise or considerable distortion in addition to the loss of high frequency response. Although the M-10 already has a built-in Head Demagnetizing Circuit, it is recommended that head demagnetization be performed periodically.

Head demagnetization can be accomplished by touching the head lightly with the demagnetizer and making several small circular motions over all head surface areas as well as the head housing.

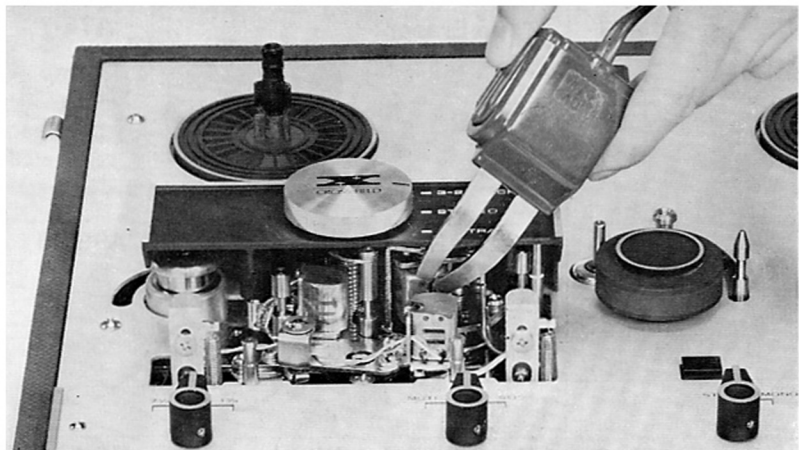

Fig. 34

III. ACCESSORIES

1. OPTIONAL ACCESSORIES

Dynamic Microphone

DM-13



Condenser Microphones

CM-15

Tape Splicer

AS-3



Tape Eraser

ATE-7

Head Demagnetizer

AH-6



Stereo Headphones

ASE-9S

Head Cleaning Kit

HC-500



Akai Connecting Cords

D-100

DR-110



DM-120

RM-130



Akai Magnetic Tapes & Tape Reels



AKAI Magnetic Tape

AT-5S (600 foot)
 AT-7S (1,200 foot)
 AT-10S (2,400 foot)
 AT-5L (900 foot)
 AT-7L (1,800 foot)
 AT-10L (3,600 foot)



AKAI Tape Reel

ATR-5 (for 5")
 ATR-7 (for 7")
 ATR-10 (for 10-1/2")

2. STANDARD ACCESSORIES

7" demonstration tape	1
7" empty reel	1
Microphone	2
Sensing tape	1
Spare fuse	2
Operator's manual	1