

AKAI SERVICE MANUAL

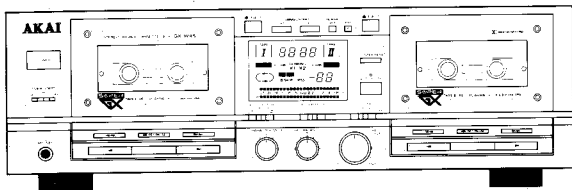

STEREO DOUBLE CASSETTE DECK

MODEL GX-W45

SPECIFICATIONS

Track system	4 track 2 channel stereo	Dolby C type NR switch ON : Improves up to 15 dB at 500 Hz, 20 dB at 1 kHz to 10 kHz
Heads		Total harmonic distortion 1.0 %
TAPE I	LC-OFC twin field SGX head for recording and playback × 1 Erase head × 1	Input sensitivity/Impedance
TAPE II	LC-OFC twin field SGX head for recording and playback × 1 Erase head × 1	LINE
Motors		Output level/Impedance
TAPE I	Electronically speed controlled DC motor × 1	LINE
TAPE II	Electronically speed controlled DC motor × 1	HEADPHONE
Wow & flutter	0.13 % (DIN), 0.08 % WRMS	Power requirements
Tape winding time	105 sec. (C 60)	AC 220 V, 50 Hz for Europe except UK
Frequency response		AC 110 V / 120 V / 220 V / 240 V, 50 / 60 Hz convertible for other countries
Normal	25 Hz to 17,000 Hz ± 3 dB	Dimensions
CrO ₂	25 Hz to 17,000 Hz ± 3 dB	425 (W) × 137 (H) × 353 (D) mm
METAL	25 Hz to 17,000 Hz ± 3 dB	Weight
S/N	56 dB (Measured via METAL tape with peak recording level)	6.0 kg
	Dolby B type NR switch ON : Improves up to 5 dB at kHz, 10 dB above 5 kHz.	
		Standard accessories
		RCA pin connection cord
		Remote control unit
		R 6 (AA) size dry batteries
		Operator's manual

* For Improvement purposes, specifications and design are subject to change without notice.

* Noise reduction manufactured under license from dolby laboratories licensing corporation.
"DOLBY" and  symbol are trade marks of dolby licensing corporation.

★ SAFETY INSTRUCTIONS

PRECAUTIONS DURING SERVICING

- Parts identified by the \triangle (*) symbol are critical for safety. Replace only with parts number specified.
- In addition to safety, other parts and assemblies are specified for conformance with such regulations as those applying to spurious radiation. These must also be replaced only with specified replacements.
Examples: RF converters, tuner units, antenna selector switches, RF cables, noise blocking capacitors, noise blocking filters, etc.
- Use specified internal wiring. Note especially:
 - Wires covered with PVC tubing
 - Double insulated wires
 - High voltage leads
- Use specified insulating materials for hazardous live parts. Note especially:
 - Insulation Tape
 - PVC tubing
 - Spacers (Insulating Barriers)
 - Insulation sheets for transistors
 - Plastic screws for fixing microswitch (especially in turntable)
- When replacing AC primary side components (transformers, power cords, noise blocking capacitors, etc.), wrap ends of wires securely about the terminals before soldering.



- Observe that wires do not contact heat producing parts (heatsinks, oxide metal film resistors, fusible resistors, etc.).

- Check that replaced wires do not contact sharp edged or pointed parts.
- Also check areas surrounding repaired locations.
- Use care that foreign objects (screws, solder droplets, etc.) do not remain inside the set.

SAFETY CHECK AFTER SERVICING

After servicing, make measurements of leakage-current or resistance in order to determine that exposed parts are acceptably insulated from the supply circuit.

The leakage-current measurement should be done between accessible metal parts (such as chassis, ground terminal, microphone jacks, signal-input/output connectors, etc.) and the earth ground through a resistor of 1500 ohms paralleled with a 0.15 μ F capacitor, under the unit's normal working conditions. The leakage-current should be less than 0.5 mA rms AC.

The resistance measurement should be done between accessible exposed metal parts and power cord plug prongs with the power switch (if included) "ON". The resistance should be more than 2.2 Mohms.

MAKE YOUR CONTRIBUTION TO PROTECT THE ENVIRONMENT

Used batteries with the ISO symbol for recycling as well as small accumulators (rechargeable batteries), mini-batteries (cells) and starter batteries should not be thrown into the garbage can.



Please leave them at an appropriate depot. All other household batteries can be thrown out with the household waste.

★ INFORMATION

SYMBOLS FOR PRIMARY DESTINATION

Alpha/beta indicates the destination of the units as listed below.

Symbols	Principal Destinations
A	USA
B	UK
C	Canada
E	Europe(except UK)
J	Japan
S	Australia
V	W.Germany only
U	Universal Area
V*	Custom version

VOLTAGE CONVERSION (U Model only)

Before connecting the power cord, set the VOLTAGE SELECTOR located on the rear panel with the flat type screwdriver so that the correct voltage for your area is indicated.

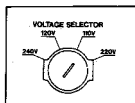

I. DISASSEMBLY

In case of trouble, etc., necessitating dismantling, please dismantle in the order shown in the illustrations.
Reassemble in reverse order.

1. Removal of UPPER COVER

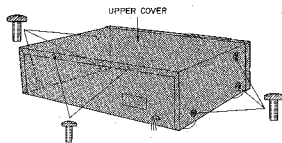

3.

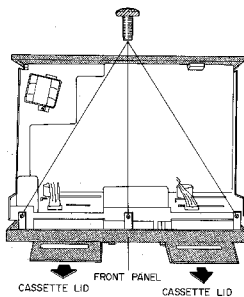

* Remove CASSETTE LID first, then remove FRONT PANEL next.

2. Removal of FRONT PANEL

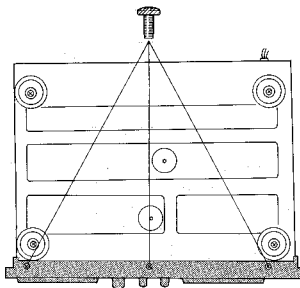

4. Removal of MECHA. BLOCK

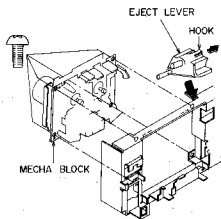

- 1) Disconnect all the connectors from the MECHA. BLOCK.
- 2) Move the EJECT LEVER to center of the unit while releasing the HOOK.
- 3) Remove the four MECHA. BLOCK fixation screws, then pull out the MECHA. BLOCK from the rear side.

II. PRINCIPAL PARTS LOCATION

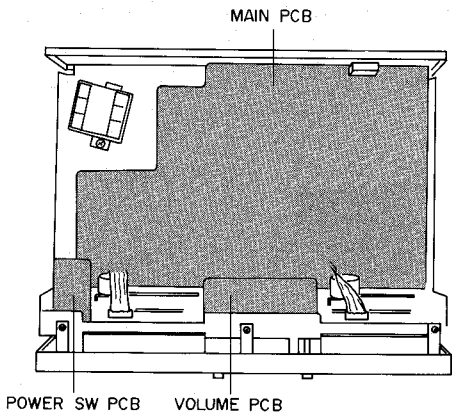

Fig. 2-1 Top view

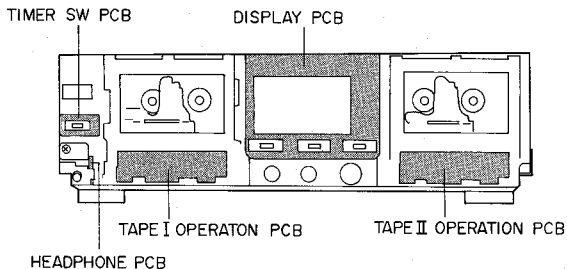
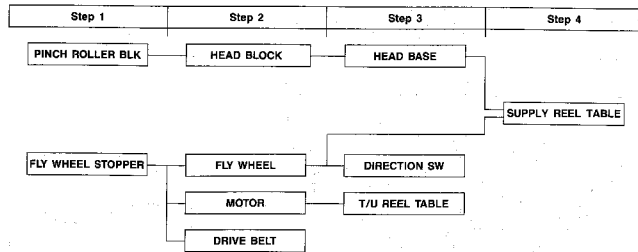

Fig. 2-2 Front view

III. REPLACEMENT OF PRINCIPAL MECHANICAL PARTS

3-1. DISASSEMBLE PROCEDURE OF PRINCIPAL MECHANICAL PARTS

* Please refer to "1. DISASSEMBLY" for removal of MECHA. BLOCK.



3-2. REPLACEMENT OF THE PINCH ROLLER BLK

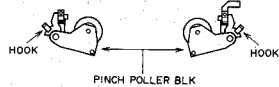

Fig. 3-1

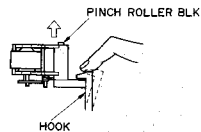

Fig. 3-2

- 1) Pull out the PINCH ROLLER BLK while releasing the HOOK as shown Fig. 3-2.
- 2) Just push the PINCH ROLLER BLK to the shaft.

3-3. REPLACEMENT OF THE HEAD BLK

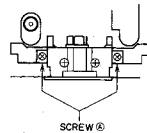

Fig. 3-3

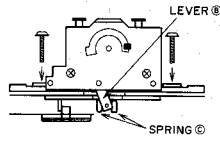

Fig. 3-4

- 1) Remove two screws (A), then remove HEAD BLK.
- 2) When reassembling the HEAD BLK, be sure that the LEVER (B) is set into the SPRING (C) as shown Fig. 3-4, then secure two screws (A) as shown Fig. 3-3.

3-4. REMOVAL OF THE FLY WHEEL STOPPER

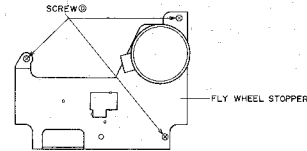

Fig. 3-5

- 1) Remove the three screws (D), then remove the FLY WHEEL STOPPER.
- 2) Reassemble in the reverse order.

3-5. REPLACEMENT OF THE REEL TABLE

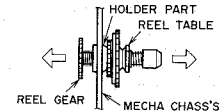

Fig. 3-6

- 1) Pull up the REEL TABLE and REEL GEAR in the direction of the two arrows (E) as shown in Fig. 3-6.
- 2) When reassembling the REEL TABLE and REEL GEAR, set the play of the REEL TABLE so that it is slightly loose.

IV. MECHANICAL ADJUSTMENT

[PRECAUTION]

- * Before adjustment, clean and de-magnetize the heads and tape guides.
- * Do not use magnetized tools for the following adjustments.

4-1. CONFIRMATION OF THE PINCH ROLLER PRESSURE

- * Before confirmation of the pinch roller pressure, remove the cassette lid and cassette holder.

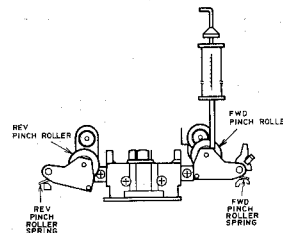

Fig. 4-1

Engage the FWD PLAY mode. Push the FWD PINCH ROLLER shaft down with the SPRING GAUGE so that the FWD PINCH ROLLER is kept 1 or 2 mm away from the capstan, then reduce the pressure of the SPRING GAUGE little by little and read the SPRING GAUGE at the moment the FWD PINCH ROLLER touches the capstan and begins to rotate. If the pressure is not within 270 ± 50 g, replace the PINCH ROLLER SPRING. Also confirm in the REV PLAY mode in the same manner as above.

4-2. CONFIRMATION OF THE WINDING TORQUE IN EACH MODE

Insert a CASSETTE TORQUE METER (AT-751179) and measure the torque in each mode. For fast forward and rewind, measure the torque at the end of the tape when the tape has stopped running.

In FWD PLAY or REV PLAY mode

Take up torque : $40 \frac{+20}{-10}$ g-cm

Back tension torque : $20 \frac{+25}{-15}$ g-cm

In FAST FORWARD and REWIND mode

Take up torque : $90 \frac{+30}{-20}$ g-cm

4-3. ADJUSTMENT OF THE REC/PB HEAD AZIMUTH ALIGNMENT

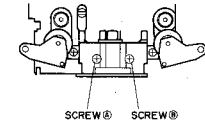

Fig. 4-2

- 1) Connect the AC milli-voltmeters to the L-ch. and R-ch of the LINE OUT and connect the oscilloscope's input CH-1 and CH-2 to the output of the AC milli-voltmeters.
- 2) Play back a 10 kHz, -15 VU test tape (AT-750778) and adjust the REC/PB HEAD AZIMUTH ALIGNMENT (F) (FWD PLAY) or (G) (REV PLAY) SCREW so that the reading on the AC milli-voltmeters are at maximum and waveforms on the oscilloscope are in the same phase.
- 3) After adjustment, paint lock the REC/PB HEAD AZIMUTH ALIGNMENT (F) and (G) SCREWS.

VI. ELECTRICAL ADJUSTMENT

[PRECAUTIONS BEFORE ADJUSTMENT]

- Before adjustment, clean and de-magnetize heads and tape guides.
- Unspecified switches and control knobs are set as below.
 - REC LEVEL control : Maximum (10) position
 - REC BALANCE control : Center (click) position
 - DOLBY NR switch : OFF
 - REV SELECTOR switch : STD
 - REC/PB MODE switch : STD
 - CHARACTOR MODE switch : OFF
- Adjust in FWD mode, then confirm in REV mode.
- Use the following recording test tapes.
 - NORMAL position : MAXELL UD 180
 - CrO₂ position : TDK SA 60
 - METAL Position : TDK MA 60
- 0 dBs = 0.775 V
- While adjusting the QUICK REVERSE SENSITIVITY in STEP 10 and 11, hold up the PACK DETECTION SW as shown in the figure below.

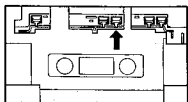

STEP	ADJUSTMENT ITEM
1.	TEST TAPE/INPUT SIGNAL
2.	MODE
3.	TEST POINT, ADJUSTMENT PART
4.	REMARKS (*) and RESULT (*)

Test point ADJ. part

11	TAPE II QUICK REVERSE SENSITIVITY
1.	PLAY (Refer to PRECAUTION STEP 6.)
2.	MODE
3.	TP7, VR17
4.	Connect a DC voltmeter between TP7 and GND. *DC 7.0 ± 0.5 V

13	TAPE I PLAYBACK LEVEL
1.	315 Hz test tape (AT-750773)
2.	PLAY
3.	LINE OUT, VR1 (L-ch) / VR1b (R-ch)
4.	Connect the AC milli-voltmeters to LINE OUT. *±6.0 ± 0.2 dbS

12	LEVEL METER SENSITIVITY
1.	1 kHz, -4.5 dBs (LINE OUT), NORMAL recording test tape
2.	REC PAUSE
3.	LEVEL METER on the front pane, VR13 (L-ch) / VR13b (R-ch)
4.	*All white segments on the level meter are lit.

9	TAPE II HX PRO RESONANCE FREQUENCY
1.	CrO ₂ recording test tape
2.	REC PLAY
3.	TP3 (+) and TP4 (-), T5 and T5b
4.	Connect a DC voltmeter between TP3 (+) and TP4 (-). *Adjust T5 and T5b alternately so that the reading on the DC voltmeter is at minimum.

3	TAPE II ERASE RESONANCE FREQUENCY
1.	CrO ₂ recording test tape
2.	REC PLAY (REC/PB MODE SW: SIMUL.)
3.	TP9 (+) and TP11 (-), T4
4.	Connect a DC voltmeter between TP9 (+) and TP11 (-). *Reading on the DC voltmeter is at minimum

8	TAPE I HX PRO RESONANCE FREQUENCY
1.	CrO ₂ recording test tape
2.	REC PLAY
3.	TP1 (+) and TP2 (-), T3 and T3b
4.	Connect a DC voltmeter between TP1 (+) and TP2 (-). *Adjust T3 and T3b alternately so that the reading DC voltmeter is at minimum.

7	TAPE II NORMAL TAPE SPEED
1.	3,150 test tape (AT-751263)
2.	PLAY
3.	LINE OUT, VR18
4.	Connect a frequency counter to LINE OUT. *5 Hz to 10 Hz lower than the result in STEP 5 TAPE I NORMAL TAPE SPEED.

6	TAPE II (* 2) TAPE SPEED
1.	3,150 test tape (AT-751263)
2.	PLAY (connect TP8 to GND)
3.	LINE OUT, VR19
4.	Connect a frequency counter to LINE OUT. *5 Hz to 10 Hz lower than the result in STEP 4 TAPE I (* 2) TAPE SPEED.

5	TAPE I NORMAL TAPE SPEED
1.	3,150 test tape (AT-751263)
2.	PLAY
3.	LINE OUT, VR15
4.	Connect a frequency counter to LINE OUT. *3,150 ± 5 Hz

4	TAPE I (* 2) TAPE SPEED
1.	3,150 test tape (AT-751263)
2.	PLAY (connect TP6 to GND)
3.	LINE OUT, VR16
4.	Connect a frequency counter to LINE OUT. *6,300 ± 10 Hz

10	TAPE I QUICK REVERSE SENSITIVITY
1.	PLAY (Refer to PRECAUTION STEP 6.)
2.	MODE
3.	TP5, VR14
4.	Connect a DC voltmeter between TP5 and GND. *DC 7.0 ± 0.5 V

1	BIAS OSC FREQUENCY
1.	METAL recording test tape
2.	REC PLAY
3.	TP12, T1
4.	Connect a frequency counter between TP12 and GND. *100.0 ± 0.2 kHz

2	TAPE I ERASE RESONANCE FREQUENCY
1.	CrO ₂ recording test tape
2.	REC PLAY (REC/PB MODE SW: SIMUL.)
3.	TP12, T1 and TP10 (-), T2
4.	Connect a DC voltmeter between TP9 (+) and TP10 (-). *Reading on the DC voltmeter is at minimum

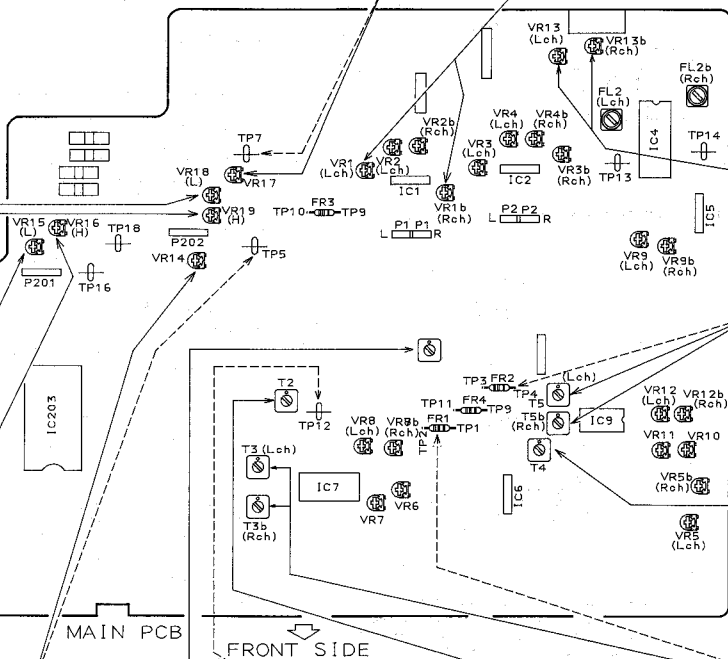

STEP	ADJUSTMENT ITEM
1.	TEST TAPE/INPUT SIGNAL
2.	MODE
3.	TEST POINT, ADJUSTMENT PART
4.	REMARKS (*) and RESULT (★)

ADJ. part

15 TAPE I PLAYBACK EQUALIZER
1. 10 kHz test tape (AT-750773)
2. PLAY
3. LINE OUT, VR2 (L-ch) / VR2b (R-ch)
4. *Connect the AC milli-voltmeters to LINE OUT. * -21.0 ± 0.3 dB

14 TAPE II PLAYBACK LEVEL
1. 315 Hz test tape (AT-750773)
2. PLAY
3. LINE OUT, VR3 (L-ch) / VR3b (R-ch)
4. *Connect the AC milli-voltmeters to LINE OUT. * -6.0 ± 0.2 dB

16 TAPE II PLAYBACK EQUALIZER
1. 10 kHz test tape (AT-750773)
2. PLAY
3. LINE OUT, VR4 (L-ch) / VR4b (R-ch)
4. *Connect the AC milli-voltmeters to LINE OUT. * -21.0 ± 0.3 dB

17 TAPE I NORMAL POSITION BIAS
1. 1 kHz and 10 kHz, -29 dBs (LINE OUT), NORMAL recording test tape.
2. REC PLAY → PLAY (Play back)
3. LINE OUT, VR8 (L-ch) / VR8b (R-ch)
4. *Connect the AC milli-voltmeters to LINE OUT. *Play back level difference between 1 kHz and 10 kHz is within ± 0.3 dB.

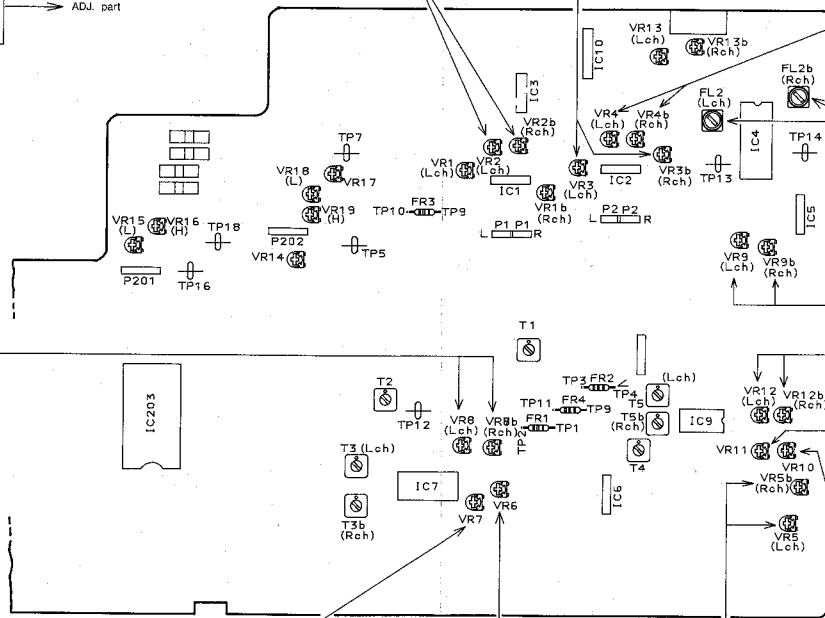

MAIN PCB

FRONT SIDE

18 TAPE I CrO ₂ POSITION BIAS
1. 1 kHz and 10 kHz, -29 dBs (LINE OUT), CrO ₂ recording test tape.
2. REC PLAY → PLAY (Play back)
3. LINE OUT, VR7
4. *Connect the AC milli-voltmeters to LINE OUT. *Play back level difference between 1 kHz and 10 kHz is within ± 0.5 dB.

19 TAPE I METAL POSITION BIAS
1. 1 kHz and 10 kHz, -29 dBs (LINE OUT), METAL recording test tape.
2. REC PLAY → PLAY (Play back)
3. LINE OUT, VR6
4. *Connect the AC milli-voltmeters to LINE OUT. *Play back level difference between 1 kHz and 10 kHz is within ± 0.5 dB.

23 TAPE I RECORDING LEVEL
1. 1 kHz, -6.0 dBs (LINE OUT), NORMAL recording test tape.
2. REC PLAY → PLAY (Play back)
3. LINE OUT, VR5 (L-ch) / VR5b (R-ch)
4. *Connect the AC milli-voltmeters to LINE OUT. * -6.0 ± 0.3 dB

22 TAPE II METAL POSITION BIAS
1. 1 kHz and 10 kHz, -29 dBs (LINE OUT), METAL recording test tape.
2. REC PLAY → PLAY (Play back)
3. LINE OUT, VR10
4. *Connect the AC milli-voltmeters to LINE OUT. *Play back level difference between 1 kHz and 10 kHz is within ± 0.5 dB.

25 MPX FILTER
1. 19 kHz, -6.0 dBs (LINE OUT, DOLBY NR switch OFF)
2. REC PAUSE
3. LINE OUT, FL2 (L-ch) / FL2b (R-ch)
4. *Connect the AC milli-voltmeters to LINE OUT and turn the DOLBY NR switch on. *Minimum output level (Less than -44 dBs)

24 TAPE II RECORDING LEVEL
1. 1 kHz, -6.0 dBs (LINE OUT), NORMAL recording test tape
2. REC PLAY → PLAY (Play back)
3. LINE OUT, VR9 (L-ch) / VR9b (R-ch)
4. *Connect the AC milli-voltmeters to LINE OUT. * -6.0 ± 0.3 dB

20 TAPE II NORMAL POSITION BIAS
1. 1 kHz and 10 kHz, -29 dBs (LINE OUT), NORMAL recording test tape.
2. REC PLAY → PLAY (Play back)
3. LINE OUT, VR12 (L-ch) / VR12b (R-ch)
4. *Connect the AC milli-voltmeters to LINE OUT. *Play back level difference between 1 kHz and 10 kHz is within ± 0.3 dB.

21 TAPE II CrO ₂ POSITION BIAS
1. 1 kHz and 10 kHz, -29 dBs (LINE OUT), CrO ₂ recording test tape.
2. REC PLAY → PLAY (Play back)
3. LINE OUT, VR11
4. *Connect the AC milli-voltmeters to LINE OUT. *Play back level difference between 1 kHz and 10 kHz is within ± 0.5 dB.

VI. PARTS LIST

ATTENTION

- When placing an order for parts, be sure to list Part No., Model No. and the description of each part. Otherwise, the non-delivery of the part or the delivery of a wrong part may result.
- Please make sure that Part No. is correct when ordering. If not, a part different from the one you ordered may be delivered.
- Since the parts shown in Parts List of Preliminary Service Manual may have been the subject of changes, please use this Parts List for all future reference.

HOW TO USE THIS PARTS LIST

- This Parts List lists those parts which are considered necessary for repairs. Other common parts, such as resistors and capacitors, are listed in the "Common List for Service Parts" from which these parts should be selected and stocked.
- The Recommended Spare Parts List shows those parts in the Parts List which are considered particularly important for service.
- Parts not shown in the Parts List and "Common List for Service Parts" will not in principle be supplied.
- How to read the Parts List.

a) Mechanism Block

b) PC Board

2. HEAD BASE BLOCK

Ref.No.	Part No.	Description
1	BH-T2023A320A	HEAD BASE BLOCK
2	HP-H2206A010A	HEAD R/P PR4-8FU C
3	ZS-477878	PAN20+03STL CMT
4	ZS-636488	BD220+08STL CMT
5	ZG-402895	SP CS ANGLE ADJUST

SP (Service Parts) Classification
This number corresponds with the individual parts index number in that figure.

6. MAIN PC BOARD

Ref.No.	Part No.	Description
1	IC1-EI-324536	IC HD140498P
2	IC2-EI-336901	IC MD8841-564M
3	C1A-EC-336939	C MMY V 223M 250AC [U,E,B,S]
4	C1B-EC-335949	C MMY V 223M 250DC [L]
5	C1C-EC-338397	C MMY V 223M 125AC [CA]
6	X1-EI-318394	OSC XTAL NC-18C

Symbols for primary destination
[A] : AAL (U.S.A.) [S] : SAA (Australia)
[B] : BEAB (England) [U] : UJT (Universa Area)
[C] : CSA (Canada)
[E] : CEE (Europe) [V] : VDE (W. Germany)
[J] : JPN (Japan) [Y] : Custom Version

SP (Service Parts) Classification
These reference symbols correspond with component symbols in the Schematic Diagrams.

The available PC Board Blocks are listed separately.

- When Part No. is known, Parts Index at end of Parts List can be used to locate where that part is shown in Parts List by its Reference No. listed at right of Part No.

WARNING

(*) INDICATES SAFETY CRITICAL COMPONENTS. FOR CONTINUED SAFETY, REPLACE SAFETY CRITICAL COMPONENTS ONLY WITH MANUFACTURE'S RECOMMENDED PARTS.

AVERTISSEMENT

(*) IL INDIQUE LES COMPOSANTS CRITIQUES DE SECURITE. POUR MAINTENIR LE DEGRE DE SECURITE L'APPAREIL, NE REMPLACER QUE DES PIECES RECOMMANDEES PAR LE FABRICANT.

1. RECOMMENDED SPARE PARTS

We suggest you to stock the following Recommended Spare Part items listed below since they can cover most of the routine service.

Ref.No.	Part No.	Description
1	BL-726310J	PINCH ROLLER ARM (L)
2	BL-726312J	PINCH ROLLER ARM (R)
3	BM-726322J	MOTOR CARPSTAN MMJ-032LWN2
4	*ST-394767J	TRANS POW1 0120 E [E]
5	*ST-394788J	TRANS POW T2120 U
6	ED-383034J	D LED SLR-54PC3F LM GREEN [FWD.L]
7	ED-307572	D SILICON H 1GS131
8	ED-824803	D SILICON H 1S2473
9	*ED-370990	D SILICON 1SR35-100AHS F10
10	ED-346548	D ZENER H HZ11AZL
11	ED-350019	D ZENER H HZ20-3L
12	ED-346583	D ZENER H HZ30-3L
13	ED-309555	D ZENER H HZ4 B0
14	ED-336558	D ZENER H HZ5 B1
15	ED-337286	D ZENER H HZ6 C2
16	ED-346529	D ZENER H HZ6C2L
17	ED-346538	D ZENER H HZ6ZL
18	*EF-336906	FUSE SEMKO 1 250V 250MA [E]
19	*EF-295344	FUSE SEMKO T 250V 800MA [E]
20	*EF-306949	FUSE TSC A 250V 1.25A [U]
21	*EF-306125	FUSE TSC A 250V 315MA [U]
22	EI-373990	IC DA15218N
23	EL-380199J	IC BU4066BL
24	EL-389989	IC CA20187
25	EL-715003	IC DN8851
26	EL-366327	IC HA12067NT
27	EL-337013	IC LS1290
28	EI-387761J	IC M50747-138SP T2109-8
29	EL-357498	IC MS1143AL
30	EI-348799	IC M9292L
31	EI-306726	IC TC4069UBP
32	EI-373983	IC UPC1297CA
33	EL-372021	OSC OSC E W/C C7880MC 6.0MHZ
34	EM-381891J	IND FL B-C 59SG DOUBLE
35	EC-389552J	COIL OSC 1 T2119 EH 1000KHZ
37	EC-373458	COIL OSC 1 2206-02 1000KHZ
38	EC-373581	COIL OSC 1 2406-01 1000KHZ
39	*ER-328278	F FUSE H ERD2FC 1/4W 10R0G
40	*ER-208095	F FUSE H S10 ERD2FC 1/4W 5R6J
41	*ER-328619	F FUSE H S10 ERD2FC 1/4W 6R0G
42	ES-725975J	SW LEAF MSW-1412 [DIRECTION SW]
43	ES-726358J	SW LEAF MSW-1628S [MODE SW]
44	ES-726359J	SW LEAF MTS1014:MVDO [CASSETTE DET SW]
45	*ES-371104	SW PUSH 500L1 01-1 [POWER]
46	ES-389838J	SW ROTARY SRR234 04-3N [CIRCUIT]
47	ES-370965	SW SLIDE SSSU02 1-01-03N [TIMER]
48	ES-356784	SW SLIDE 03130366 1-01-03N [REV SELECTOR]
49	ES-349474	SW TACT SKH1HM004A [X1 BUJ]
50	ET-381637J1	DETECTOR GPIU521X
51	ET-356336	TR DT1-14ES
52	ET-388928	TR DT1-14VS
53	ET-354365	TR DT1-14VDS
54	ET-354364	TR DT1-143TS
55	ET-373391	TR DT1-1432S
56	ET-354414	TR DT1-144ES
57	ET-389903J	TR 2S4335-HS
58	ET-389907J	TR 2S81009 QJR
59	ET-389908J	TR 2S81425 EU

Ref.No.	Part No.	Description
60	ET-38825J	TR 2SC1740S S F05
61	ET-388977	TR 2SC227AK F F06
62	ET-378924J	TR 2SC2383A STU
63	ET-37929J	TR 2SD1380 QR
64	ET-366581	TR 2SD1785 EF
65	ET-389862J	TR 2SD150 V F05
66	EV-389865J	VR ROTARY RK 6Y112B0 A1042 [REC LEVEL]
67	EV-389904J	VR ROTARY RK 63111 10 SPCL W104 [REC BALANCE]
68	*EW-363654	AC CORD 200 C129AVFF B300 A U [U]
69	*EW-363667	AC CORD 200 C384 LCLFL B300 A E [U]
70	HR-H251A020A	HEAD EPR4-16
71	MB-726349J	MECH CARSTAN
72	MB-726369J	BELT FF

2. MECHA BLOCK (1)

Ref.No.	Part No.	Description
1	BH-729404J	HEAD BLK EPR4-16
4	ZG-726301J	SP HEAD
5	ZG-726319J	SP ROD
6	ZG-726331J	SP HEAD BSASE
7	ML-726302J	ARM TAKE-UP
8	ZG-726930J	SP ARM TAKE-UP
9	BR-729304J	SUPPLY REEL TABLE
10	BR-729305J	TAKE-UP REEL TABLE
11	ML-726308J	LEVER SWITCH
12	ML-726307J	GEAR TAKE-UP
13	MC-729309J	ROD BRAKE
14	ML-726303J	LEVER LOCK
15	BL-726310J	PINCH ROLLER ARM (L)
16	ZG-726311J	SP PINCH ROLLER ARM (L)
17	BL-726312J	PINCH ROLLER ARM (R)
18	ZG-726313J	SP PINCH ROLLER ARM (R)
19	MZ-726314J	ELECT ROD [MECHA BLK (L) ONLY]
20	ZG-726320J	SP ELECT ROD [MECHA BLK (L) ONLY]
21	MZ-726936J	ELECT ROD [MECHA BLK (R) ONLY]
22	MZ-726937J	ELECT ROD [MECHA BLK (R) ONLY]
23	MZ-726915J	DUMPER ARM
24	ML-726315J	LEVER MAIN
26	ML-726316J	SP HEAD BASE
27	ML-726306J	DUMPER ARM (B)
29	ZS-726351J	SCREW 26X03
30	ZS-726352J	SCREW 20X08
31	HR-H251A020A	HEAD EPR4-16 EPR4-16

NOTE:

Parts will not be supplied if they are not listed in the parts list, even if they appear on the assembling illustrations with reference No.

MECHA BLOCK (1)

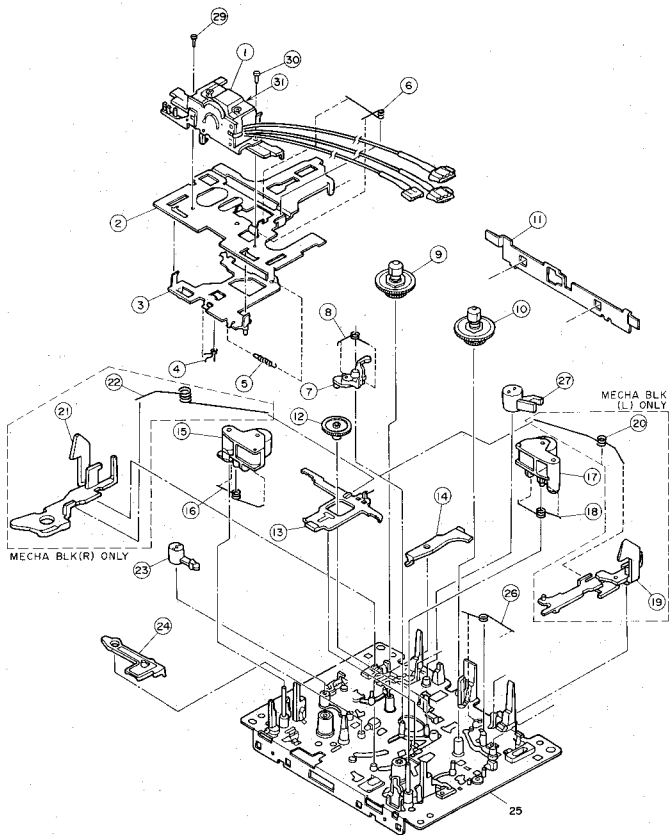

MECHA BLOCK (2)

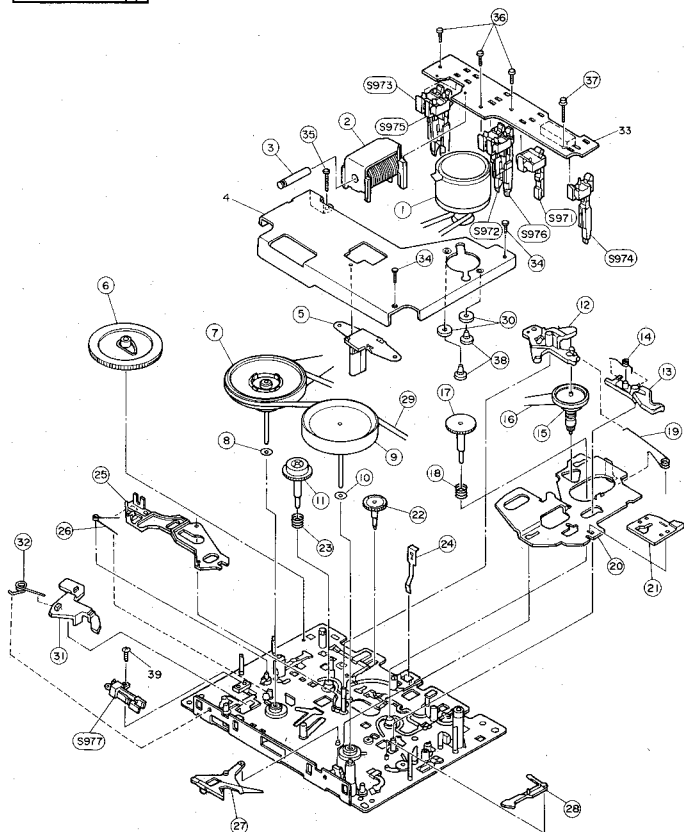

NOTE:

Parts will not be supplied if they are not listed in the parts list, even if they appear on the assembling illustrations with reference No.

3. MECHA BLOCK (2)

Ref.No.	Part No.	Description
1	BM-726322J	MOTOR CAPSTAN MMU-5B2LWN2
2	EP-726323J	SOLENOID
3	MZ-726324J	SHAFT SOLENOID
5	MZ-726325J	BASE THRUST
6	MZ-726326J	GEAR MAIN
7	BF-726327J	FLYWHEEL (R)
8	ZW-726328J	WASHER THRUST
9	BF-726329J	FLYWHEEL (L)
10	ZW-726330J	WASHER THRUST
11	MZ-726331J	GEAR REEL TABLE (J)
12	ML-726332J	ARM FF
13	ML-726333J	LEVER FF(K)
14	ZG-726334J	SP LEVER FF
15	MR-726335J	PULLEY MAIN(J)
16	MB-726336J	BELT FF
17	MZ-726337J	GEAR REEL TABLE
18	ZG-726083J	SP BACK TENSION RUQ111ZA
19	ZG-726339J	SP ROD FF
20	MZ-726340J	ROD FF(FK)
21	MZ-726341J	ROD FF
22	MZ-726342J	GEAR FF
23	ZG-720084J	SP BACK TENSION RUQ112ZA
24	ZG-726344J	SP CASSETTE STOPPER
25	ML-726345J	LEVER TRIGGER
26	ZG-726346J	SP TRIGGER LEVER
27	ML-726347J	LEVER
28	ML-726348J	LEVER FF
29	MB-726349J	BELT CAPSTAN
30	SZ-725971J	CUSHION GUM
31	ML-725972J	LEVER SW
32	ZG-725973J	SP LEVER SW
34	ZS-726353J	SCREW 26X07
35	ZS-726354J	SCREW 26X16
36	ZS-726355J	SCREW 20X08
37	ZS-726356J	SCREW 20X16
38	ZS-725976J	SCREW
D971	ED-307572	D SILICON H 1SS131
IC971	EI-15093	IC DM6851
S971	ES-726358J	SW LEAF MSW-1628S [MODE SW]
S972	ES-726359J	SW LEAF MTS10141MVD0 [CASSETTE DET SW]
S973	ES-726359J	SW LEAF MTS10141MVD0 [ANTI-REC(REV) SW]
S974	ES-726359J	SW LEAF MTS10141MVD0 [ANTI-REC(FWD) SW]
S975	ES-726359J	SW LEAF MTS10141MVD0 [CROSS DET SW]
S976	ES-726359J	SW LEAF MTS10141MVD0 [METAL DET SW]
S977	ES-725975J	SW LEAF MSW-1412 [DIRECTION SW]

4. P.C BOARD

Ref.No.	Part No.	Description
1	BA-T2120A020B	PC(#) PRE & SYSCON BLK GX-W45(U)
	[U]	
2	BA-T2120A020C	PC(#) PRE & SYSCON BLK GX-W45(E)
	[E]	
3	BA-T2120A030A	PC(#) DISPLAY BLK GX-W4500

PC (#) PRE & SYSCON BLK CONSISTS OF FOLLOWING P.C BOARD.

- MAIN P.C BOARD
- VOLUME P.C BOARD
- POWER SW P.C BOARD
- HEADPHONE P.C BOARD
- TIMER SW P.C BOARD

PC (#) DISPLAY BLK CONSISTS OF FOLLOWING P.C BOARD.

- DISPLAY P.C BOARD
- OPERATION (1) P.C BOARD
- OPERATION (2) P.C BOARD

5. MAIN P.C BOARD

Ref.No.	Part No.	Description
C81	EC-347247	C MC V F05 FM 101J 500DC
C83	EC-347187	C MC V F05 FM 6R0D 500DC
C103	EC-366613	C EC V CUT SME 102M 25.0DC
C104	EC-366613	C EC V CUT SME 102M 25.0DC
C111	EC-363490	C EC V CUT SME 222M 16.0DC
C112	EC-363490	C EC V CUT SME 222M 16.0DC
C113	EC-362141	C EC V CUT SME 472M 16.0DC
C115	EC-366613	C EC V CUT SME 102M 25.0DC
D1	*ED-370990	D SILICON 1SR35-100AHS F10
D2	*ED-370990	D SILICON 1SR35-100AHS F10
D3	*ED-370990	D SILICON 1SR35-100AHS F10
D4	*ED-370990	D SILICON 1SR35-100AHS F10
D5	*ED-370990	D SILICON 1SR35-100AHS F10
D6	*ED-370990	D SILICON 1SR35-100AHS F10
D7	*ED-370990	D SILICON 1SR35-100AHS F10
D8	*ED-370990	D SILICON 1SR35-100AHS F10
D9	*ED-370990	D SILICON 1SR35-100AHS F10
D10	*ED-370990	D SILICON 1SR35-100AHS F10
D11	*ED-370990	D SILICON 1SR35-100AHS F10
D12	*ED-370990	D SILICON 1SR35-100AHS F10
D13	*ED-370990	D SILICON 1SR35-100AHS F10
D14	ED-346538	D ZENER H HZ8A2L
D15	ED-346538	D ZENER H HZ8A2L
D16	ED-337285	D ZENER H HZ8 C2
D17	ED-307572	D SILICON H 1SS131
D18	ED-346529	D ZENER H HZ6C2L
D19	ED-338559	D ZENER H HZ8 B1
D20	ED-346548	D ZENER H HZ11A2L
D21	ED-330219	D ZENER H HZ20-2L
D22	ED-346583	D ZENER H HZ30-3L
D23	ED-305855	D ZENER H HZ4 B3
D24	ED-307572	D SILICON H 1SS131
D25	ED-307572	D SILICON H 1SS131
D26	ED-307572	D SILICON H 1SS131
D27	ED-307572	D SILICON H 1SS131
D201	ED-307572	D SILICON H 1SS131
D202	ED-307572	D SILICON H 1SS131
D203	ED-307572	D SILICON H 1SS131
D204	ED-307572	D SILICON H 1SS131
D205	ED-307572	D SILICON H 1SS131
D206	ED-307572	D SILICON H 1SS131
D207	ED-307572	D SILICON H 1SS131
D208	ED-624903	D SILICON H 1S2473
D209	ED-624903	D SILICON H 1S2473
D210	ED-307572	D SILICON H 1SS131
D211	ED-307572	D SILICON H 1SS131
D212	ED-307572	D SILICON H 1SS131
D213	ED-307572	D SILICON H 1SS131
D214	ED-307572	D SILICON H 1SS131
D215	ED-307572	D SILICON H 1SS131
D216	ED-307572	D SILICON H 1SS131
D217	ED-307572	D SILICON H 1SS131
D218	ED-307572	D SILICON H 1SS131
D219	ED-307572	D SILICON H 1SS131
D220	ED-307572	D SILICON H 1SS131
F1A	*EF-306125	FUSE TSC A 250V 315MA [U]
F1B	*EF-339906	FUSE SEMKO T 250V 250MA [E]
F2A	*EF-306125	FUSE TSC A 250V 315MA [U]
F2B	*EF-339906	FUSE SEMKO T 250V 250MA [E]
F3A	*EF-306949	FUSE TSC A 250V 1.25A [U]
F3B	*EF-258344	FUSE SEMKO T 250V 800MA [E]
F4A	*EF-306949	FUSE TSC A 250V 1.25A [U]
F4B	*EF-258344	FUSE SEMKO T 250V 800MA [E]
FL1	EH-328491J1	FILTER DB D07-003K 100KHZ
FL2	BH-364198	FILTER DB 425-5070-02
FL3	EO-323982	COIL TUN 1 100Z-431 100.00KHZ
FL4	EO-323982	COIL TUN 1 100Z-431 100.00KHZ
FR1	*ER-200595	R FUSE H S10 ERD2FC 1/4W 5R6J
FR2	*ER-200595	R FUSE H S10 ERD2FC 1/4W 5R6J
FR3	*ER-326278	R FUSE H ERD2FC 1/4W 10R0G
FR4	*ER-326278	R FUSE H ERD2FC 1/4W 10R0G

Ref.No.	Part No.	Description
FR5	4ER-328519	R FUSE H S10 ERD2FC 1/4W 68R0G
IB201	EH-385419J	COMP R RGL7E7X 472J
IB202	EH-385419J	COMP R RGL7E7X 472J
IB203	EH-385420J	COMP R RGL6E8X 104J
IB204	EH-385421J	COMP R RGL7E7X 103J
IC1	EI-348785	IC M5220L
IC2	EI-348785	IC M5220L
IC3	EI-380199J	IC BU40665L
IC4	EI-359985	IC CX20187
IC5	EI-357498	IC M51143AL
IC6	ER-373980	IC BA15218N
IC7	EI-373383	IC UPC1297CA
IC8	EI-373980	IC BA15218N
IC9	EI-373383	IC UPC1297CA
IC10	EI-373980	IC BA15218N
IC201	EI-337008	IC LC7800
IC202	EI-337008	IC LC7800
IC203	EI-385781J	IC M50747-1388P T2109-B
IC204	EI-306726	IC TC4069UBP
J1	EJ-336905	PIN J AJC-035-ACB P 4P
L1	EO-379950J	COIL FIX 1 7132 223J
L2	EO-357050	COIL FIX 1 RC875 822J
L3	EO-389935J	COIL FIX 8 16821822J 822J/682K
R177	ER-378675J	R OMF H S10 FS 1/2W 181J
R178	ER-378675J	R OMF H S10 FS 1/2W 181J
TR1	ET-378524J	TR 25C3383 S,T,U
TR2	ET-378524J	TR 25C3383 S,T,U
TR3	ET-389251J	TR 25C1740S S F05
TR4	ET-389251J	TR 25C1740S S F05
TR5	ET-389251J	TR 25C1740S S F05
TR6	ET-356336	TR DTA114ES
TR7	ET-354414	TR DTC144ES
TR8	ET-354414	TR DTC144ES
TR9	ET-378524J	TR 25C3383 S,T,U
TR10	ET-378524J	TR 25C3383 S,T,U
TR11	ET-389251J	TR 25C1740S S F05
TR12	ET-389251J	TR 25C1740S S F05
TR13	ET-356336	TR DTA114ES
TR14	ET-354414	TR DTC144ES
TR15	ET-354414	TR DTC144ES
TR16	ET-389251J	TR 25C1740S S F05
TR17	ET-389251J	TR 25C1740S S F05
TR18	ET-354415	TR DTA144ES
TR19	ET-354415	TR DTA144ES
TR20	ET-354414	TR DTC144ES
TR21	ET-354414	TR DTC144ES
TR22	ET-354414	TR DTC144ES
TR23	ET-354414	TR DTC144ES
TR24	ET-354414	TR DTC144ES
TR25	ET-389251J	TR 25C1740S S F05
TR26	ET-389251J	TR 25C1740S S F05
TR27	ET-389251J	TR 25C1740S S F05
TR28	ET-389251J	TR 25C1740S S F05
TR30	ET-389251J	TR 25C1740S S F05
TR31	ET-389251J	TR 25C1740S S F05
TR32	ET-389251J	TR 25C1740S S F05
TR33	ET-354364	TR DTC143TS
TR34	ET-354414	TR DTC144ES
TR35	ET-354364	TR DTC143TS
TR36	ET-354414	TR DTC144ES
TR37	ET-389251J	TR 25C1740S S F05
TR38	ET-389251J	TR 25C1740S S F05
TR39	ET-389802J	TR 25D2159 V F05
TR40	ET-308977	TR 25C2274K F F05
TR41	ET-308977	TR 25C2274K F F05
TR42	ET-389251J	TR 25C1740S S F05
TR44	ET-389251J	TR 25C1740S S F05
TR46	ET-389251J	TR 25C1740S S F05
TR47	ET-389251J	TR 25C1740S S F05
TR48	ET-389251J	TR 25C1740S S F05
TR49	ET-389251J	TR 25C1740S S F05
TR50	ET-389251J	TR 25C1740S S F05
TR51	ET-354364	TR DTC143TS
TR52	ET-354414	TR DTC144ES
TR53	ET-354364	TR DTC143TS
TR54	ET-354414	TR DTC144ES
TR55	ET-389251J	TR 25C1740S S F05
TR56	ET-389251J	TR 25C1740S S F05
TR57	ET-389802J	TR 25D2159 V F05
TR58	ET-308977	TR 25C2274K F F05
TR59	ET-308977	TR 25C2274K F F05

Ref.No.	Part No.	Description
TR60	ET-354414	TR DTC144ES
TR61	ET-389251J	TR 25C1740S S F05
TR62	ET-389251J	TR 25C1740S S F05
TR63	ET-389251J	TR 25C1740S S F05
TR64	ET-389251J	TR 25C1740S S F05
TR65	ET-389251J	TR 25C1740S S F05
TR66	ET-379239	TR 25D1380 Q,R
TR67	ET-389807J	TR 25B1909 Q,R
TR68	ET-389251J	TR 25C1740S S F05
TR69	ET-389803J	TR 25A933S R,S
TR70	ET-379239	TR 25D1380 Q,R
TR71	ET-366581	TR 25D1762 E,F
TR72	ET-379239	TR 25D1380 Q,R
TR73	ET-378524J	TR 25C3383 S,T,U
TR74	ET-389251J	TR 25C1740S S F05
TR75	ET-389251J	TR 25C1740S S F05
TR201	ET-389251J	TR 25C1740S S F05
TR202	ET-389251J	TR 25C1740S S F05
TR203	ET-389251J	TR 25C1740S S F05
TR204	ET-389251J	TR 25C1740S S F05
TR205	ET-354414	TR DTC144ES
TR206	ET-354414	TR DTC144ES
TR207	ET-354414	TR DTC144ES
TR208	ET-389251J	TR 25C1740S S F05
TR209	ET-354365	TR DTA114Y
TR210	ET-369248	TR DTA114Y
TR211	ET-354365	TR DTC114Y
TR212	ET-369248	TR DTA114Y
TR213	ET-354365	TR DTC114Y
TR214	ET-369248	TR DTA114Y
TR215	ET-389248	TR DTA114Y
TR216	ET-369248	TR DTA114Y
TR217	ET-389251J	TR 25C1740S S F05
TR218	ET-354365	TR DTC114Y
TR219	ET-369248	TR DTA114Y
TR220	ET-369248	TR DTA114Y
TR222	ET-369248	TR DTA114Y
TR223	ET-369248	TR DTA114Y
TR225	ET-369248	TR DTA114Y
TR226	ET-369248	TR DTA114Y
TR227	ET-373391	TR DTC143ZS
TR228	ET-389806J	TR 25B1425 E,J
TR229	ET-389808J	TR 25B1425 E,J
TR230	ET-353897	TR DTC114ES
TR231	ET-389251J	TR 25C1740S S F05
TR232	ET-354414	TR DTC144ES
TR233	ET-389803J	TR 25A933S R,S
TR234	ET-389251J	TR 25C1740S S F05
TR235	ET-389251J	TR 25C1740S S F05
TR236	ET-389251J	TR 25C1740S S F05
TR237	ET-389803J	TR 25A933S R,S
TR238	ET-373391	TR DTC143ZS
TR239	ET-389808J	TR 25B1425 E,J
TR240	ET-389808J	TR 25B1425 E,J
TR241	ET-353897	TR DTC114ES
TR242	ET-389251J	TR 25C1740S S F05
TR243	ET-354414	TR DTC144ES
TR244	ET-389803J	TR 25A933S R,S
TR245	ET-389251J	TR 25C1740S S F05
TR246	ET-389251J	TR 25C1740S S F05
TR247	ET-389803J	TR 25A933S R,S
TR248	ET-389251J	TR 25C1740S S F05
TR249	ET-389803J	TR 25A933S R,S
TR250	ET-353897	TR DTC114ES
T1	EO-373561	COL OSC 1 2306-01 100.0KHZ
T2	EO-389852J	COL OSC 1 T2119 EH 100.0KHZ
T3	EO-373485	COL OSC 1 2306-02 100.0KHZ
T4	EO-389852J	COL OSC 1 T2119 EH 100.0KHZ
T5	EO-373485	COL OSC 1 2306-02 100.0KHZ
VR1	EV-356581	R S-FIX H RH0615C 0.10W 331
VR2	EV-356583	R S-FIX H RH0615C 0.10W 332
VR3	EV-356581	R S-FIX H RH0615C 0.10W 331
VR4	EV-356583	R S-FIX H RH0615C 0.10W 332
VR5	EV-358829	R S-FIX H RH0615C 0.10W 223
VR6	EV-356576	R S-FIX H RH0615C 0.10W 472
VR7	EV-357619	R S-FIX H RH0615C 0.10W 104
VR8	EV-356583	R S-FIX H RH0615C 0.10W 332
VR9	EV-358829	R S-FIX H RH0615C 0.10W 223
VR10	EV-356576	R S-FIX H RH0615C 0.10W 472
VR11	EV-357619	R S-FIX H RH0615C 0.10W 104
VR12	EV-356583	R S-FIX H RH0615C 0.10W 332

Ref.No.	Part No.	Description
VR13	EV-356582	R S-FIX H RH0615C 0.10W 473
VR14	EV-356829	R S-FIX H RH0615C 0.10W 223
VR15	EV-356679	R S-FIX H RH0615C 0.10W 682
VR16	EV-356679	R S-FIX H RH0615C 0.10W 682
VR17	EV-356829	R S-FIX H RH0615C 0.10W 223
VR18	EV-356679	R S-FIX H RH0615C 0.10W 682
VR19	EV-356679	R S-FIX H RH0615C 0.10W 682
X201	EI-372031	OSC CE W/C FCR8.0MC 3.0M-HZ

6. VOLUME P.C BOARD

Ref.No.	Part No.	Description
IC401	EI-373980	IC BA1521BN
IC402	EI-373980	IC BA1521BN
SW401	ES-389838J	SW ROTARY SRRZS4 04-3N [C-TRACTER MODE]
TR401	ET-389251J	TR 25C1740S S F05
TR402	ET-389251J	TR 25C1740S S F05
TR403	ET-389251J	TR 25C1740S S F05
VR401	EV-389804J	VR ROTARY RK1631110 SPCL W104 (REC BALANCE)
VR402	EV-389805J	VR ROTARY RK16Y12B0 A104X2 [REC LEVEL]

7. POWER SW P.C BOARD

Ref.No.	Part No.	Description
C501A	*#EC-320548	C CE V F 103Z 250AC [U]
C501B	*#EC-338411	C CE V DE7 FZ 103P 400AC [E]
SW501	*#ES-371104	SW PUSH SDDL01 01-1 [POWER]

8. HEADPHONE P.C BOARD

Ref.No.	Part No.	Description
D601	EJ-369995	PHONE J 3P HLJ0540-410 GP 6.3 [PHONES]

9. TIMER SW P.C BOARD

Ref.No.	Part No.	Description
SW10	ES-370965	SW SLIDE SSSU02 1-01-03N [TIMER]

10. DISPLAY P.C BOARD

Ref.No.	Part No.	Description
IC1	EI-337013	IC LB1280
IC2	EI-337013	IC LB1280
IC3	EI-356327	IC HA12067NT
IN1	EM-381681J	IND FL BG-529G DOUBLE
PM1	ET-381637J1	DETECTOR GP1U521X
SW1	ES-355784	SW SLIDE 00130386 1-01-03N [REV SELECTOR]
SW2	ES-355784	SW SLIDE 00130386 1-01-03N [REC/PB MODE]
SW3	ES-355784	SW SLIDE 00130386 1-01-03N [DOLBY]
TR1	ET-354415	TR DTA144ES
TR2	ET-354365	TR DTC114YS
TR3	ET-354415	TR DTA144ES
TR4	ET-354365	TR DTC114YS
TS1	ES-349474	SW TACT SKHHAM004A [X1 DUB]
TS2	ES-349474	SW TACT SKHHAM004A [X2 DUB]
TS3	ES-349474	SW TACT SKHHAM004A [PSS]
TS4	ES-349474	SW TACT SKHHAM004A [BLANK SKIP]
TS5	ES-349474	SW TACT SKHHAM004A [COUNTER RESET]
TS8	ES-349474	SW TACT SKHHAM004A [AUTO MUTE]

11. OPERATION (1) P.C BOARD

Ref.No.	Part No.	Description
D11	ED-383034J	D LED SLR-54PC3F LM GREEN [FWD]
D12	ED-383034J	D LED SLR-54PC3F LM GREEN [REV]
TS11	ES-349474	SW TACT SKHHAM004A [STOP]
TS12	ES-349474	SW TACT SKHHAM004A [FWD]
TS13	ES-349474	SW TACT SKHHAM004A [REV]
TS14	ES-349474	SW TACT SKHHAM004A [REW]
TS15	ES-349474	SW TACT SKHHAM004A [FF]
TS16	ES-349474	SW TACT SKHHAM004A [REC]

12. OPERATION (2) P.C BOARD

Ref.No.	Part No.	Description
D21	ED-383034J	D LED SLR-54PC3F LM GREEN [FWD]
D22	ED-383034J	D LED SLR-54PC3F LM GREEN [REV]
TS21	ES-349474	SW TACT SKHHAM004A [STOP]
TS22	ES-349474	SW TACT SKHHAM004A [FWD]
TS23	ES-349474	SW TACT SKHHAM004A [REV]
TS24	ES-349474	SW TACT SKHHAM004A [REW]
TS25	ES-349474	SW TACT SKHHAM004A [FF]
TS26	ES-349474	SW TACT SKHHAM004A [REC]

FINAL ASSEMBLY

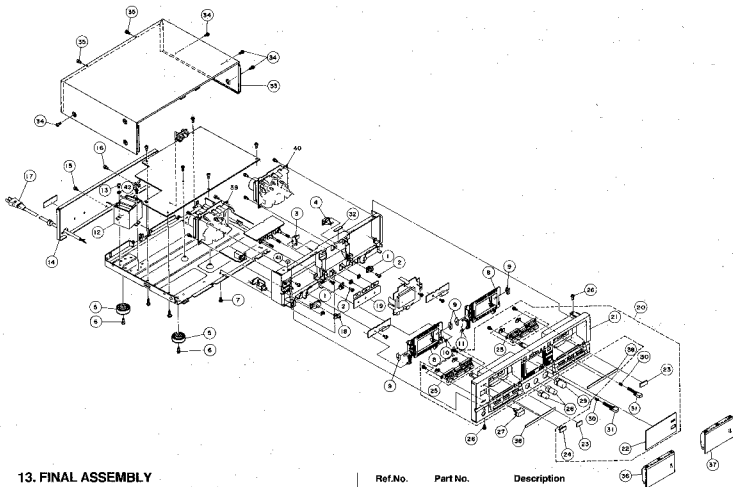

13. FINAL ASSEMBLY

Ref.No.	Part No.	Description
1	MZ-389926J	DAMPER 3F96-L
2	ZS-342001	ST BR30X08STL N13
3	ML-391454J	LEVER EJECT(L)
4	ML-391455J	LEVER EJECT(R)
5	SA-379375	FOOT(N)
6	ZS-383735J	ST BR30X10STL BNI
7	ZS-383735J	ST BR30X10STL BNI
8	SP-381534J1	HOLDER CASSETTE
9	ZG-333615	SP PLATE CASSETTE HOLDER (B)
10	ZG-391455J	SP TORSION EJECT(L)
11	ZG-391457J	SP TORSION EJECT(R)
12A	*ST-394768J	TRANS POW T2120 U
12B	*BT-394767J	TRANS POW T2120 E
13	ZS-322580	ST BID40X08STL BNI
14A	SP-395926J1	PANEL REAR GX-W45(U)
14B	SP-395927J	PANEL REAR GX-W45(E)
15	ZS-354403	ST BR30X08STL BNI
16	ZS-350934	PT BR30X08STL BNI
17A	*EW-383654	AC CORD 200 0129AVFF B300 A U/
17B	*EW-383667	AC CORD 200 0364 LCLF B300 A E
18	SK-358066B	KNOB SLIDE-BLACK
19	SE-391458J	MASK
20	BD-T2120A050B	PANEL FRONT BLK GX-W45-B
22	SE-391463J1	WINDOW
23	SZ-357722	REFLECTOR
24	SM-365756C	NAME PLATE AKAI(2)
25	BS-391598J	BUTTON OPERATION PART
26	ZS-305827	ST BID30X05STL BNI
27	SK-373236B	KNOB POWER-B

Ref.No.	Part No.	Description
28	SK-391466J	KNOB VRS
29	SK-391467J	KNOB VR M
30	ZG-381535J	SP PUSH EJECT
31	SK-381551J	KNOB EJECT
32	SZ-378311-A	CUSHION
33	SP-391493J	COVER LIPPER B
34	ZS-341960	ST BID40X08STL BNI
35	ZS-354403	ST BR30X08STL BNI
36	BD-T2120A050C	LID PANEL BLK GX-W45-B(L)
37	BD-T2120A050B	LID PANEL BLK GX-W4500-B(R)
38	SC-391464J	COVER AZMUTH
39	BB-T2120A040A	MECHA BLK GX-W4500(L)
40	BB-T2120A040B	MECHA BLK GX-W4500(R)
41	ZZ-389460J	CUSHION 9X9X4.5
42	ZW-273914	SW40

NOTE:

Parts will not be supplied if they are not listed in the parts list, even if they appear on the assembling illustrations with reference No.

14. ACCESSORY

Ref.No.	Part No.	Description
1	AX-394763J	REMOCON RC-G45

ABBREVIATIONS (CASSETTE)

ABBREVIATION	EXPLANATION	ABBREVIATION	EXPLANATION
AC	Alternating Current	MIN	MINute
A/D	Analog/Digital	MML	Maximum Modulation Level
AF	Auto Fader	MOL	Maximum Output Level
AMP	AMPLifier	MPX	Multi PleX
AR	Anti Recording	NC	Not Connected (No Connection)
AT BIAS	Auto Turning BIAS	NFB	Negative Feed Back
ATT	ATTenuator	NORM	NORMal
BAL	BALance	NR	Noise Reduction
BEF	Band Elimination Filter	OSC	OSCillator (OSCillation)
BSS	Blank Search System	P	Pulse
CAP M	CAPstan Motor	PB	Play Back
CH	CHannel	QMSS	Quick Memory Search System
COMP	COMParator	QR	Quick Reverse
CONT	CONTinuance	R CH	Right CHannel
CRLP	Computer Recording Level Processing	REC	RECOrd (RECOding)
CS	Chip Select	REV	REVerse
D/A	Digital/Analog	ROT	ROTation
DC	Direct current	REW	REWind
DET	DETECTOR	SEC	SECond
DISCRI	DISCRIminator	SELE	SELEctor
DUB	DUBbing	SENS	SENSitivity
EQ	EQUALizer	SEPP	Single Ended Push Pull
FF (or F.FWD)	Fast Forward	SIG	SIGnal
FLD	FLUorescent Display	SPECT	SPECTrum
FREQ	FREQUency	STD	STANdard
FWD	ForWard	SW	SWItch
GND	GrouND	SYSCON	SYSTEM CONTRL
H	High	TP	Test Point
HPF	High Pass Filter	TRIG	TRIGa
IND	INDicator	VCA	Voltage Control Attenuator
IPLS	Instant Program Location System	VOL	VOLume
L	Low	VOLT	VOLTage
L CH	Left CHannel	VR	Variable Resistor
LED	Light Emitting Diode	XTAL	cysTAL
MEMO	MEMOry	X1	Normal speed
MICOM	MicroCOMputer	X2	Dubble speed

AKAI

MODEL **GX-W45**

SCHEMATIC DIAGRAMS AND PC BOARDS

TABLE OF CONTENTS

1. POWER SW AND OTHER PC BOARDS	2
2. CONNECTION DIAGRAM	3
3. MAIN (1/2) SCHEMATIC DIAGRAM	4
4. MAIN PC BOARD	5
5. MAIN (2/2), DISPLAY SCHEMATIC DIAGRAM	6
6. MAIN AND OTHER PC BOARDS	7
7. SYSTEM CONTROL BLOCK DIAGRAM	8
8. MAIN BLOCK DIAGRAM	9
9. INFORMATION OF ICs	10

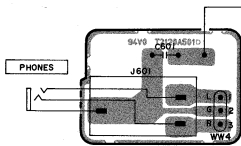

HEADPHONE PCB
T2120A50ID



JUNCTION PCB
T2120A50IF

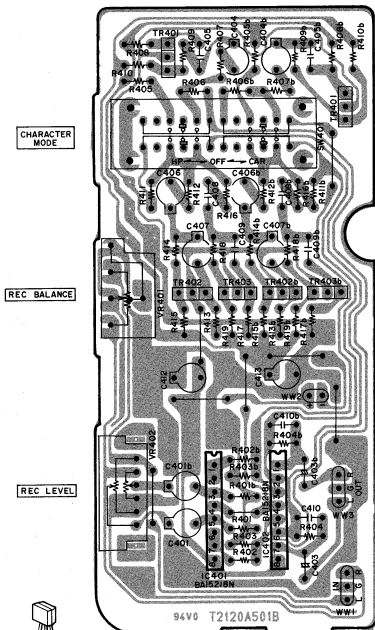

VOLUME PCB T2120A50IB

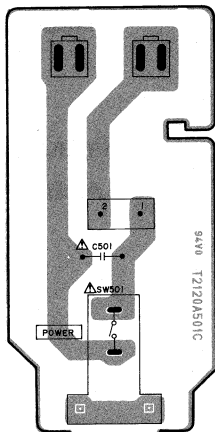

POWER SW PCB
T2120A50IC

WARNING: ⚠ INDICATES SAFETY CRITICAL COMPONENTS FOR CONTINUED SAFETY.
REPLACE SAFETY CRITICAL COMPONENTS ONLY WITH MANUFACTURER'S
RECOMMENDED PARTS

AVERTISSEMENT: ⚠ IL INDIQUE LES COMPOSANTS CRITIQUES DE SÉCURITÉ.
POUR MAINTENIR LE DEGRÉ DE SÉCURITÉ DE L'APPAREIL,
NE REMPLACER QUÉ DES PIÈCES RECOMMANDÉES PAR LE FABRICANT



2SC1740

B

••• = NPN TRANSISTOR

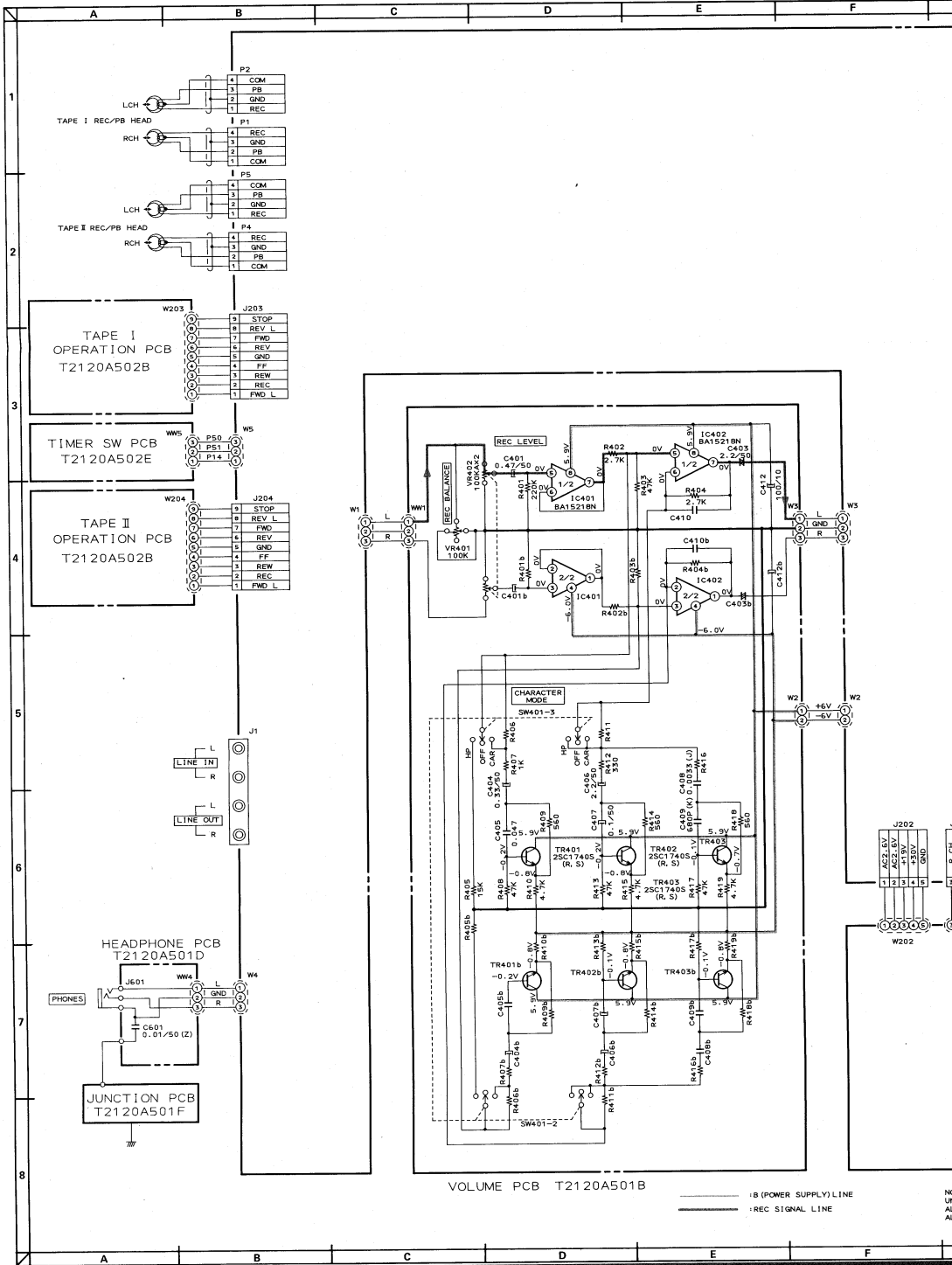

TAPE I REC/PB HEAD

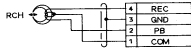

TAPE II REC/PB HEAD

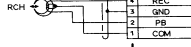
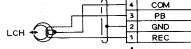

TAPE I OPERATION PCB T2120A502B

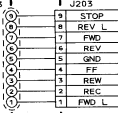

TIMER SW PCB T2120A502E



TAPE II OPERATION PCB T2120A502B

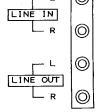
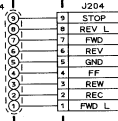

HEADPHONE PCB T2120A501D

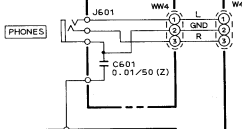

JUNCTION PCB T2120A501F

VOLUME PCB T2120A501B

- - - - - : -6.0V (POWER SUPPLY) LINE
 - - - - - : REC SIGNAL LINE

NOTE:
 UNL E
 ALL
 ALL

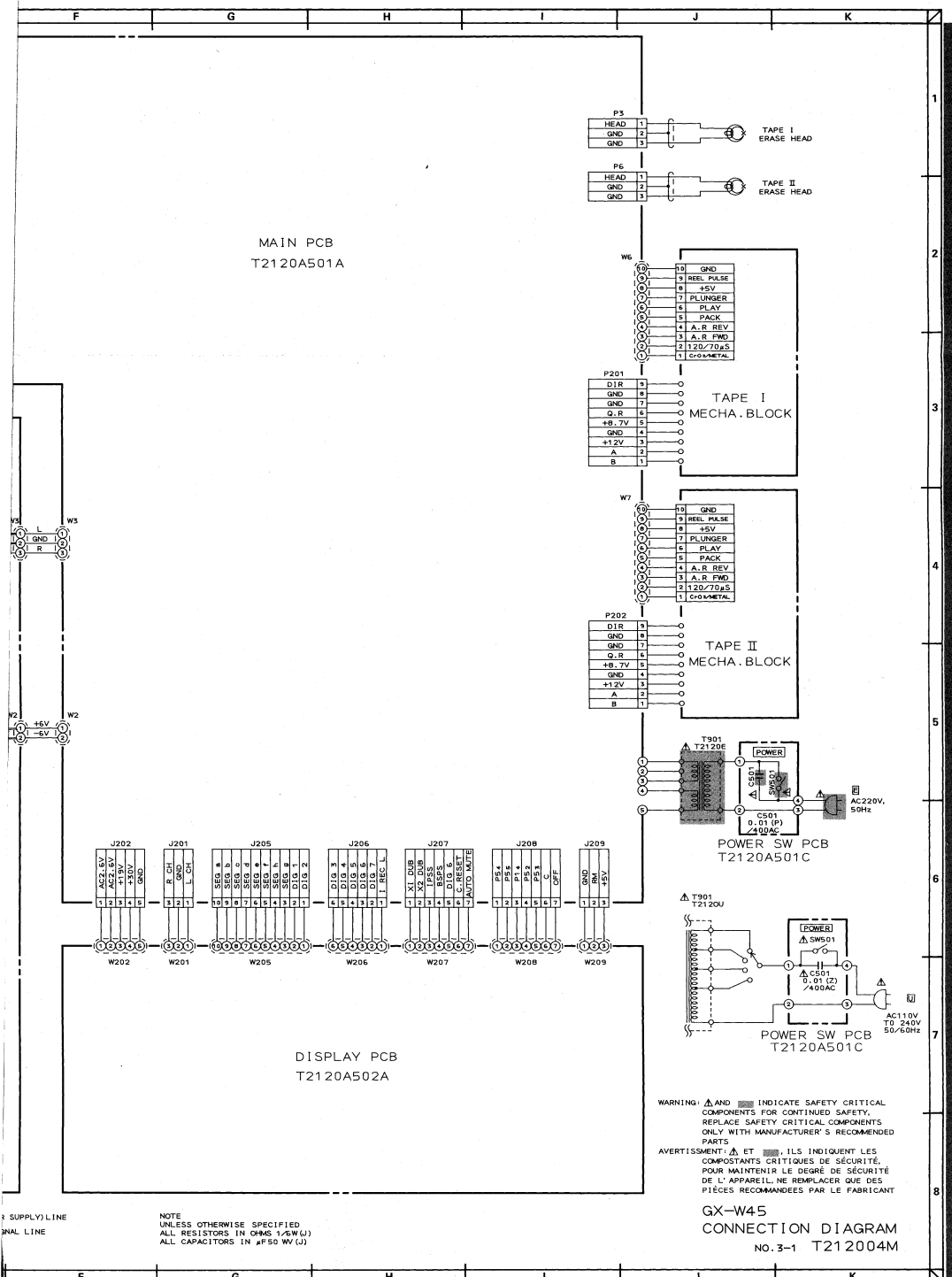

2 SUPPLY LINE
1 ANAL LINE

NOTE
UNLESS OTHERWISE SPECIFIED
ALL RESISTORS IN OHMS (Ω/W/J)
ALL CAPACITORS IN μF50 W(J)

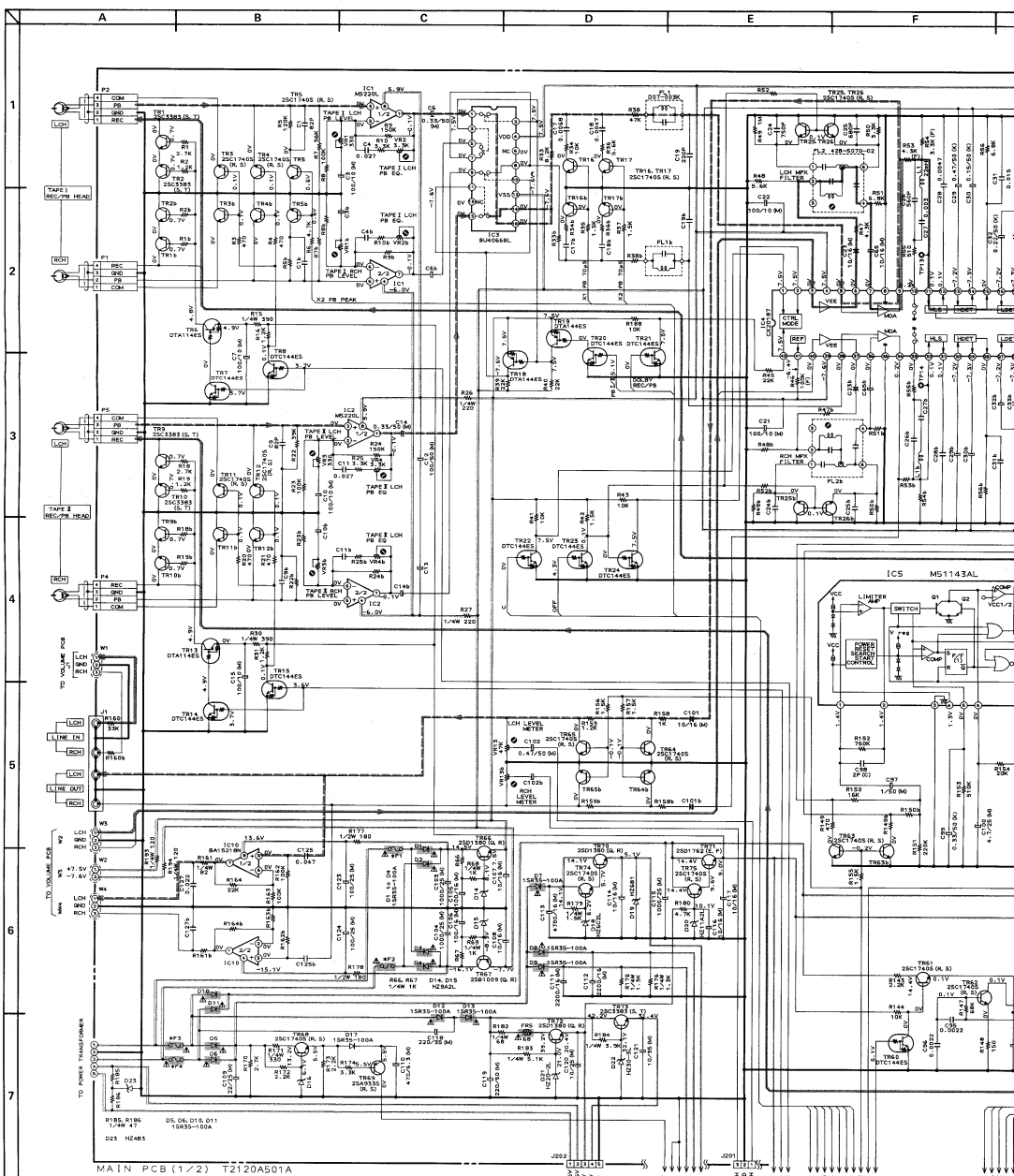

MAIN PCB (1/2) T2120A501A

WARNING: A AND B INDICATE SAFETY CRITICAL COMPONENTS FOR CONTINUED SAFETY. REPLACE SAFETY CRITICAL COMPONENTS ONLY WITH MANUFACTURER'S RECOMMENDED PARTS.
 AVERTISSEMENT: A ET B ILS INDICENT LES COMPOSANTS CRITIQUES DE SÉCURITÉ. POUR MAINTENIR LE DEGRÉ DE SÉCURITÉ DE L'APPAREIL, NE REMPLACEZ QUE DES PIÈCES RECOMMANDÉES PAR LE FABRICANT.

#	Q1	Q2	Q3
1	315A	28D	T250A 250V
2	315A	250V	T250A 250V
3	1.25A	250V	T250A 250V
4	1.25A	250V	T250A 250V

TO MAIN PCB (2/2)

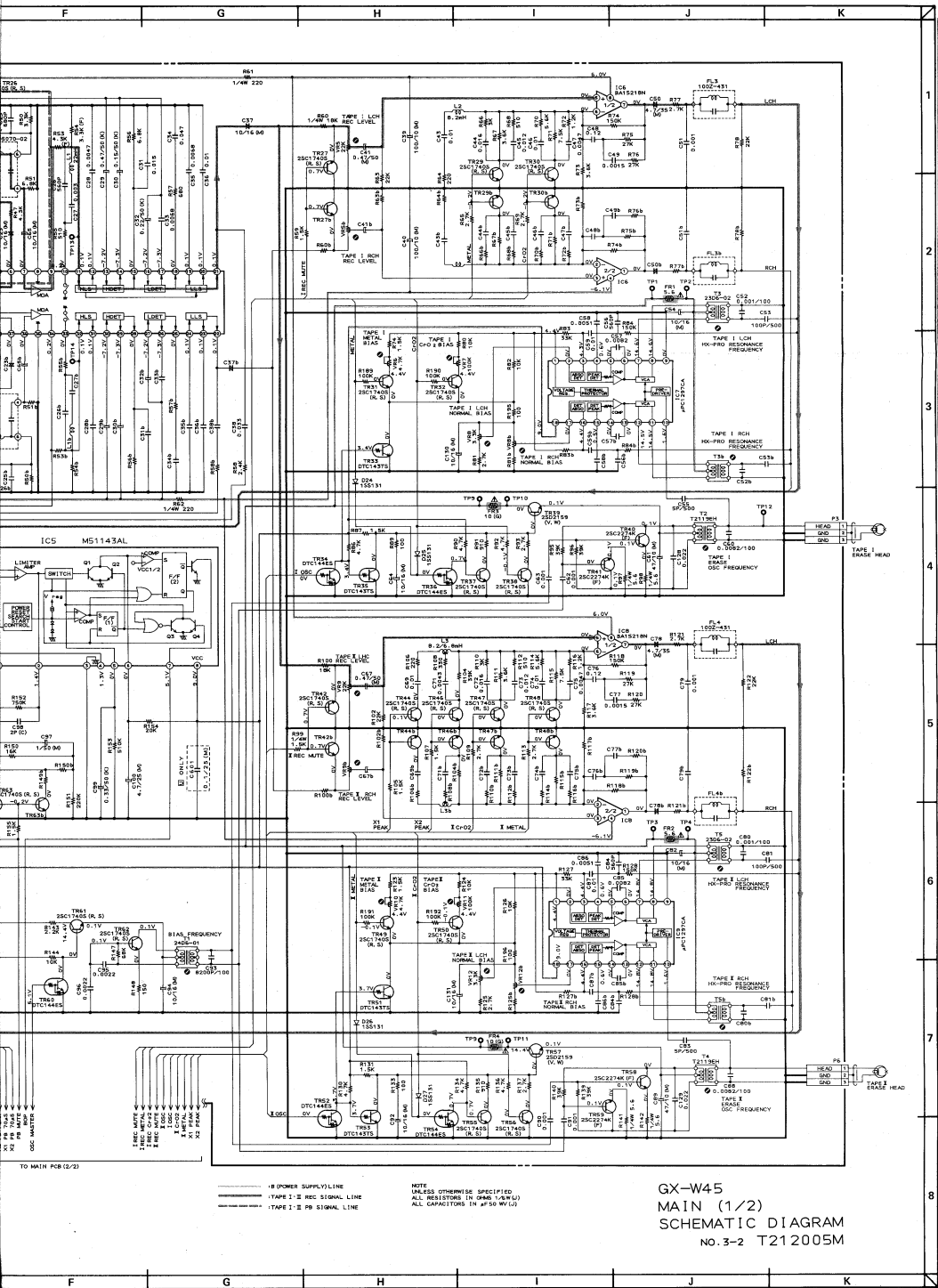

- - - - - 18 (POWER SUPPLY) LINE
 - - - - - TAPE I & REC SIGNAL LINE
 - - - - - TAPE I & PB SIGNAL LINE

NOTE: RESISTOR VALUES SPECIFIED
 UNLESS OTHERWISE SPECIFIED
 ALL RESISTORS ARE 1% TOLERANCE
 ALL CAPACITORS IN μF UNLESS SPECIFIED

GX-W45
 MAIN (1/2)
 SCHEMATIC DIAGRAM
 NO. 3-2 T212005M

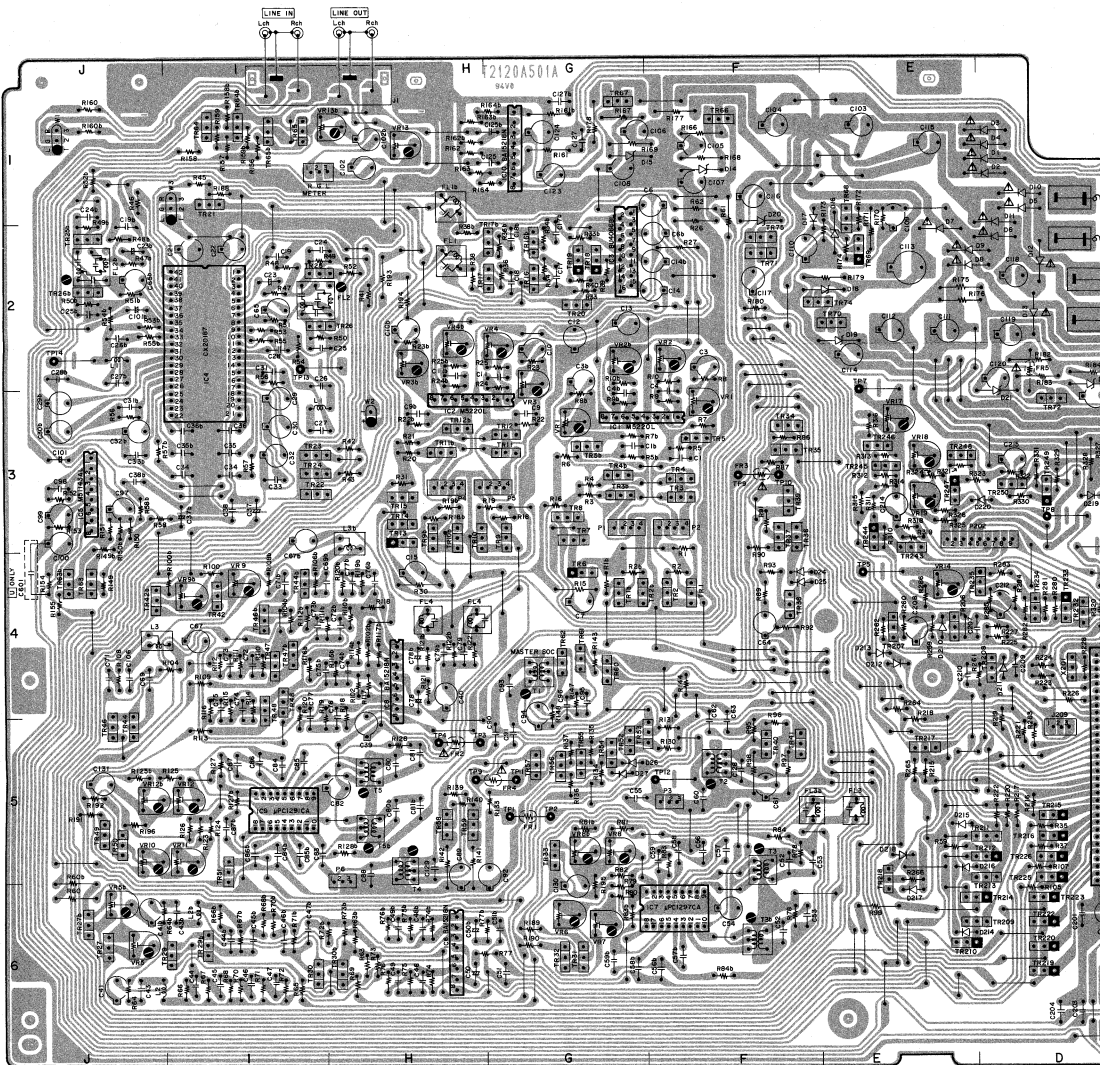

MAIN PCB T2120A501A

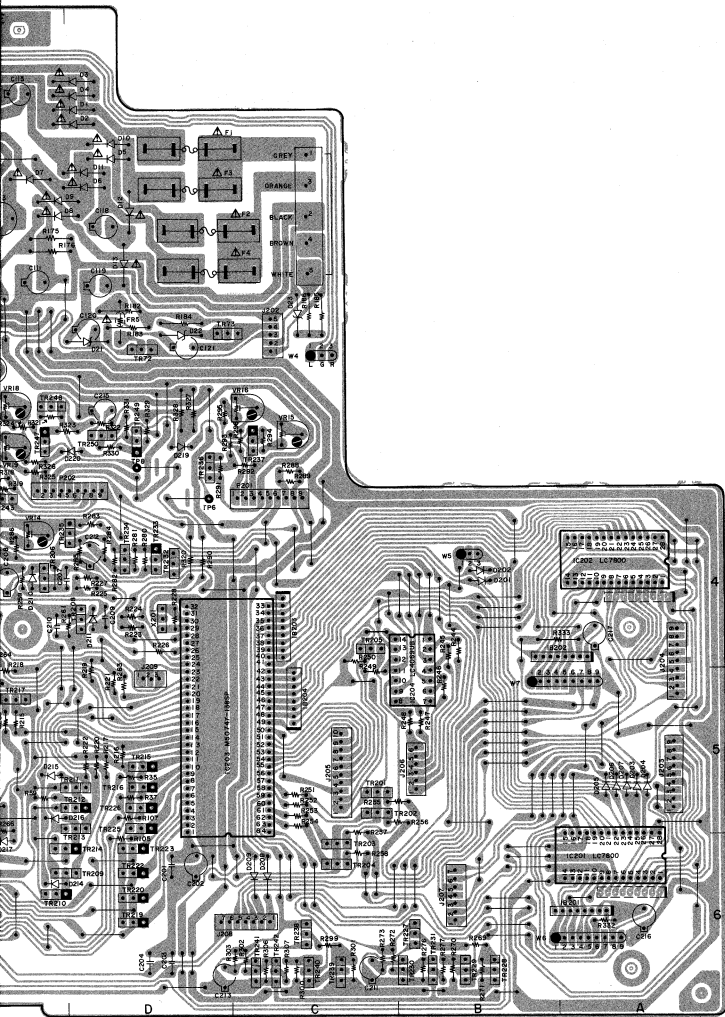

PRINCIPAL PARTS LOCATION

ICS			
IC1.....P,G3	TR36.....P3,4	TR220.....D6	
IC2.....G,H3	TR37.....P3,4	TR221.....D6	
IC3.....G1,2	TR38.....P4	TR223.....D6	
IC4.....I2	TR39.....P3	TR225.....D6	
IC5.....J3	TR40.....P5	TR226.....D5	
IC6.....H6	TR41.....P5	TR227.....B6	
IC7.....P,G6	TR42.....P4	TR228.....B6	
IC8.....H4	TR42b.....I4	TR229.....B6	
IC9.....I5	TR44.....I4	TR230.....B6	
IC10.....G1	TR44b.....J5	TR231.....B6	
IC201.....A6	TR46.....J5	TR232.....D4	
IC202.....A4	TR45b.....I4	TR233.....D4	
IC204.....B4,5	TR47.....I4	TR234.....D4	
TRANSISTOR	TR47b.....I4	TR235.....D4	
TR1.....F4	TR48.....I4	TR236.....D3	
TR1b.....G4	TR49b.....I4	TR237.....C3	
TR2.....F4	TR49.....J5	TR238.....C6	
TR2b.....G4	TR50.....J5	TR239.....C6	
TR3.....F3	TR51.....I5,6	TR240.....C6	
TR3b.....G3	TR52.....G5	TR241.....C6	
TR4.....F3	TR53.....G5	TR242.....C6	
TR4b.....G3	TR54.....G5	TR243.....E4	
TR5.....F3	TR55.....G5	TR244.....E3,4	
TR5b.....G3	TR56.....G5	TR245.....E3	
TR6.....F4	TR57.....G5	TR246.....E3	
TR6b.....G4	TR60.....G4	TR247.....E3	
TR8.....G3	TR61.....G4	TR248.....E3	
TR9.....G3,4	TR62.....G4	TR248.....E3	
TR9b.....H3,4	TR63.....J4	TR250.....D3	
TR10.....G,H3,4	TR63b.....I4		
TR10b.....H3	TR64.....I1	CONNECTOR	
TR11.....G3	TR64b.....I1	P1.....G3	
TR12.....G3	TR65.....H1	P2.....P3	
TR12b.....H3	TR65b.....H1	P3.....P5	
TR13.....H3	TR66.....F1	P4.....H3	
TR14.....H3	TR67.....G1	P5.....G,H3	
TR15.....H3	TR68.....E1,2	P6.....H,16	
TR16.....G2	TR69.....E2	P201.....C,D4	
TR16b.....G2	TR70.....E2	P202.....D,E4	
TR17.....G2	TR71.....F2	J1.....H,11	
TR17b.....G2	TR72.....D3	J202.....D6	
TR18.....G2	TR73.....C,D3	J203.....A5	
TR19.....G2	TR74.....E,F2	J204.....A4,5	
TR20.....G2	TR75.....F2	J205.....C5	
TR21.....H1	TR201.....C5	J206.....B5	
TR22.....I3	TR202.....C5	J207.....B6	
TR23.....I3	TR203.....C6	J208.....C,D6	
TR24.....I3	TR204.....C6		
TR25.....I2	TR205.....C4		
TR25b.....J2	TR206.....E4		
TR26.....I2	TR207.....E4		
TR26b.....J2	TR208.....D4		
TR27.....J6	TR209.....D,B6		
TR27b.....J6	TR210.....D,B6		
TR29.....I6	TR211.....D5		
TR29b.....I6	TR212.....D5		
TR30.....I6	TR212b.....D,B6		
TR30b.....I6	TR214.....D,B6		
TR31.....G6	TR215.....D5		
TR32.....G6	TR216.....D5		
TR33.....G6	TR217.....E5		
TR33b.....F5	TR218.....E5,6		
TR34.....G5	TR219.....D6		
TR35.....F3			

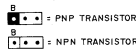

WARNING: Δ INDICATES SAFETY CRITICAL COMPONENTS. FOR CONTINUED SAFETY, REPLACE SAFETY CRITICAL COMPONENTS ONLY WITH MANUFACTURER'S RECOMMENDED PARTS. CRITICAL COMPONENTS ONLY WITH MANUFACTURER'S RECOMMENDED PARTS.

AVERTISSEMENT: ΔΔ. INDIQUE LES COMPOSANTS CRITIQUES DE SÉCURITÉ. POUR MAINTENIR LE DEGRÉ DE SÉCURITÉ DE L'APPAREIL, NE REMPLACEZ QUE DES PIÈCES RECOMMANDÉES PAR LE FABRICANT.

2SA9338	2SB1425
2SC1740S	2SC2274K
JFA114	2SC3383
DTC114	2SD2159
DTC143	
DTC144	

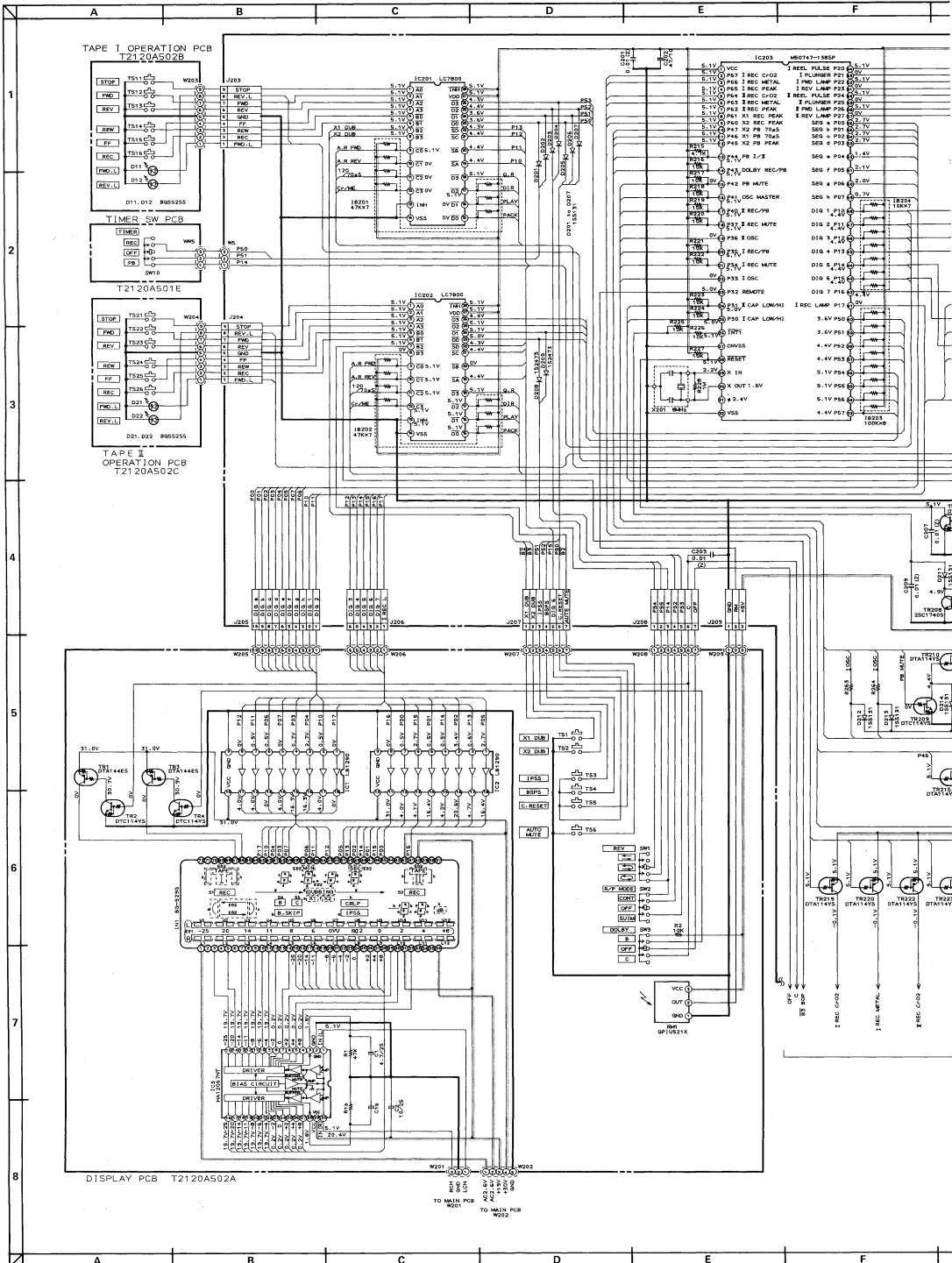

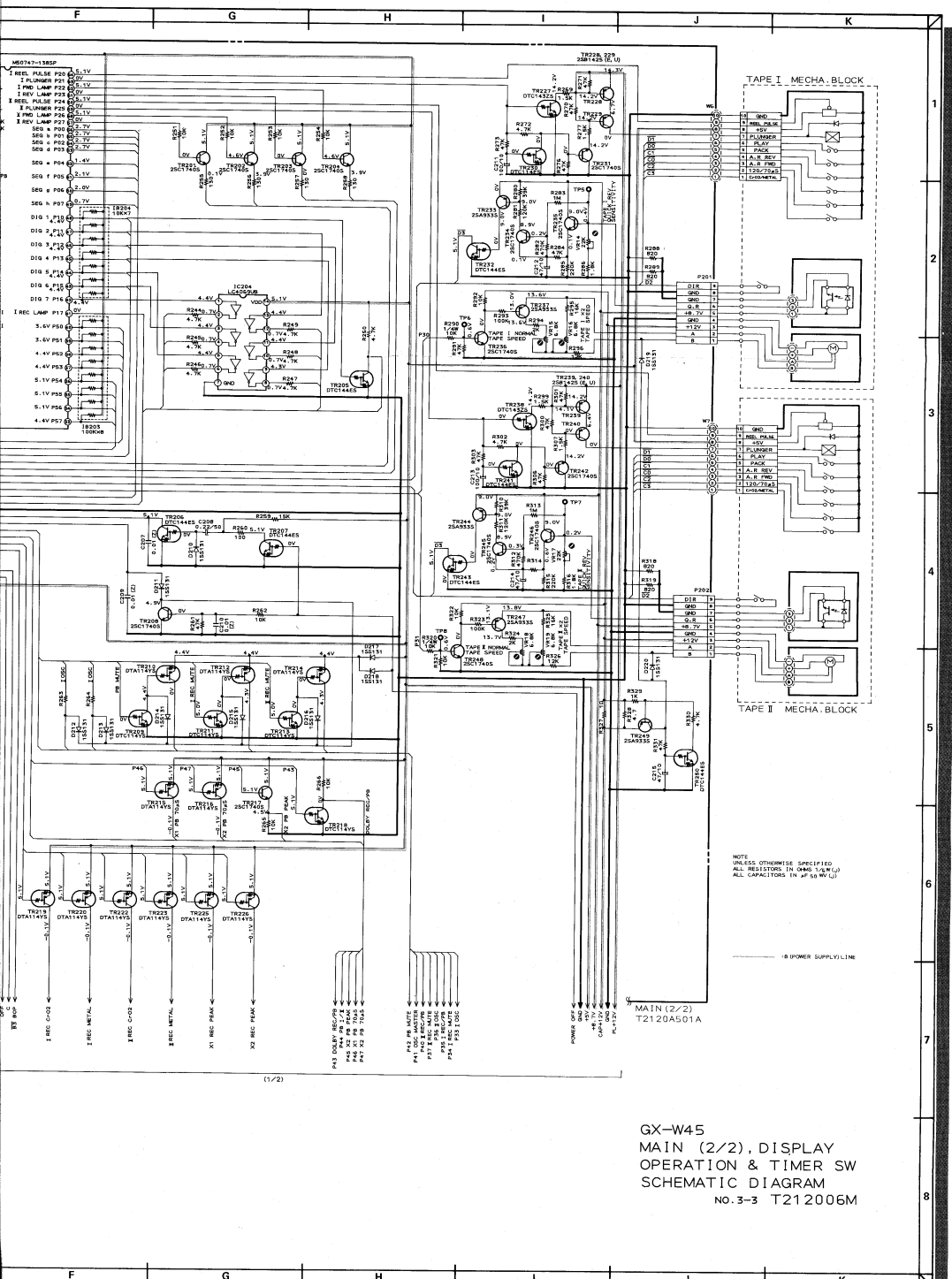

(1/2)

NOTE
UNLESS OTHERWISE SPECIFIED
ALL RESISTORS IN OHMS, 1/4W, 1%
ALL CAPACITORS IN μ F, 50 WV, 10

— B POWER SUPPLY LINE

GX-W45
MAIN (2/2), DISPLAY
OPERATION & TIMER SW
SCHEMATIC DIAGRAM
NO. 3-3 T212006M

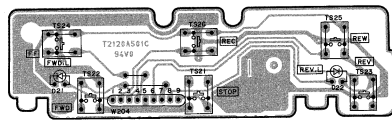
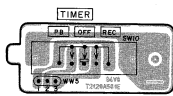
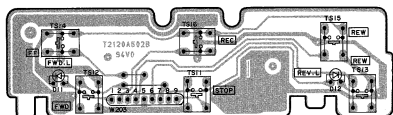
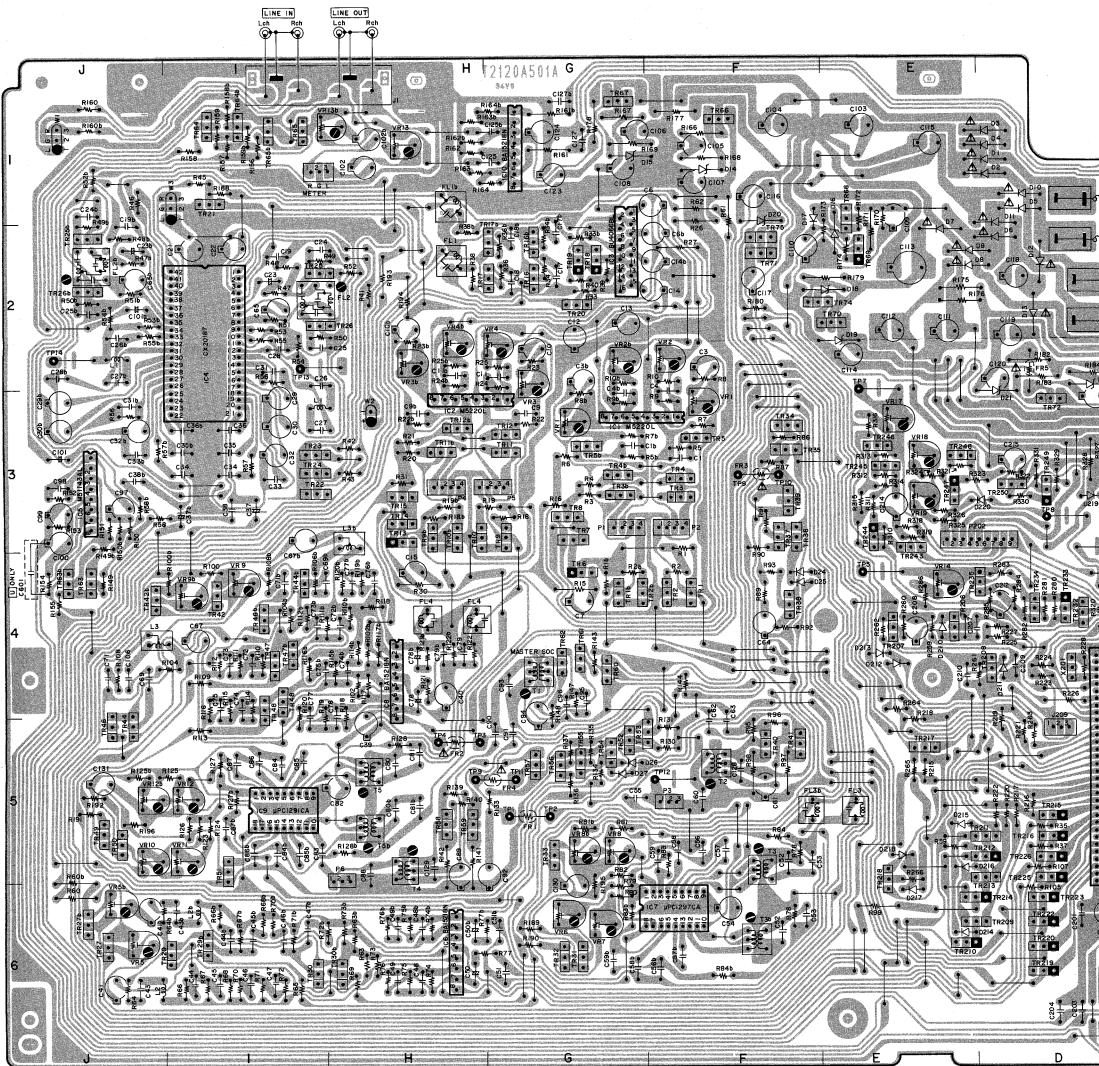

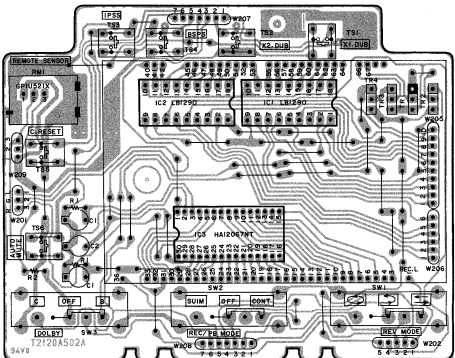
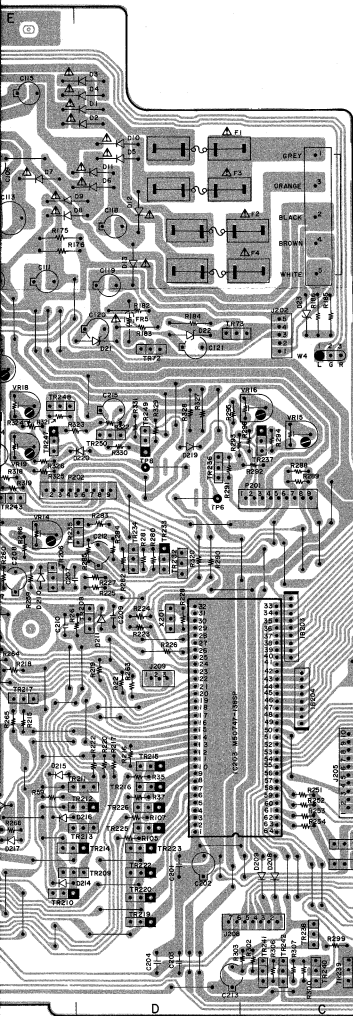

DISPLAY PCB T210A502A

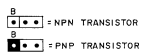

PRINCIPAL PARTS LOCATION

ICs			
IC1.....F,G3	TR36.....F3,4	TR220.....D6	
IC2.....G,H3	TR37.....F3,4	TR221.....D6	
IC3.....G1,2	TR38.....F4	TR223.....D6	
IC4.....I2	TR39.....F3	TR225.....D6	
IC5.....J3	TR40.....P5	TR226.....D5	
IC6.....H6	TR41.....P5	TR227.....D6	
IC7.....P,G6	TR42.....J4	TR228.....D6	
IC8.....H4	TR42B.....I4	TR229.....D6	
IC9.....I5	TR44.....I4	TR230.....B6	
IC10.....G1	TR44B.....J5	TR231.....D6	
IC201.....A6	TR46.....J5	TR232.....D4	
IC202.....A4	TR46B.....I4	TR233.....D4	
IC204.....B4,5	TR47.....I4	TR234.....D4	
TRANSISTOR			
TR1.....F4	TR47B.....I4	TR235.....D4	
TR7.....F4	TR48.....I4	TR236.....D3	
TR1b.....G4	TR48B.....I4	TR237.....C3	
TR2.....F4	TR49.....J5	TR238.....C6	
TR2b.....G4	TR50.....J5	TR239.....C6	
TR3.....F3	TR51.....I5,6	TR240.....C6	
TR3b.....G3	TR52.....G5	TR241.....C6	
TR4.....F3	TR53.....G5	TR242.....C6	
TR4b.....G3	TR54.....G5	TR243.....E4	
TR5.....F3	TR55.....G5	TR244.....E3,4	
TR5b.....G3	TR56.....G5	TR245.....E3	
TR6.....G4	TR57.....G5	TR246.....E3	
TR7.....G3	TR60.....G4	TR247.....E3	
TR8.....G3	TR61.....G4	TR248.....E3	
TR9.....G3,4	TR62.....G4	TR249.....D3	
TR9b.....H3,4	TR63.....J4	TR250.....D3	
TR10.....G,H3,4	TR63b.....J4	CONNECTOR	
TR10b.....H3	TR64.....I1	P1.....G3	
TR11.....G3	TR64b.....I1	P2.....F3	
TR12.....H3	TR65.....H1	P3.....P5	
TR12b.....H3	TR65b.....H1	P4.....H3	
TR13.....H3	TR66.....P1	P5.....G,H3	
TR14.....H3	TR67.....G2	P6.....H,I,H1	
TR15.....G2	TR69.....E1,2	P201.....C,D4	
TR16b.....G2	TR69b.....E2	P202.....D,E4	
TR17.....G2	TR70.....E2	J1.....H1	
TR17b.....G2	TR71.....P2	J202.....C3	
TR18.....G2	TR72.....D3	J203.....A5	
TR18b.....G2	TR73.....C,D3	J204.....A4,5	
TR19.....G2	TR74.....E,P2	TR20.....G2	
TR20.....G2	TR75.....P2	TR201.....C5	
TR21.....H1	TR201.....C5	J206.....B5	
TR22.....I3	TR202.....C5	J207.....B6	
TR23.....I3	TR203.....C6	J208.....C,D6	
TR24.....I3	TR204.....C6		
TR25.....I2	TR205.....C4		
TR25b.....I2	TR206.....B4		
TR26.....I2	TR207.....B4		
TR26b.....I2	TR208.....D4		
TR27.....J6	TR209.....D,D6		
TR27b.....J6	TR210.....D,D6		
TR29.....I6	TR211.....D5		
TR29b.....I6	TR212.....D5		
TR30.....I6	TR213.....D,D6		
TR31.....G6	TR214.....D,D6		
TR32.....G6	TR215.....D5		
TR33.....G6	TR216.....D5		
TR34.....G5	TR217.....E5		
TR35.....F3	TR218.....E5,6		
	TR219.....E6		

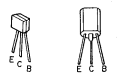
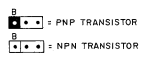

WARNING: Δ INDICATES SAFETY CRITICAL COMPONENTS FOR CONTINUED SAFETY.
 REPLACE SAFETY CRITICAL COMPONENTS ONLY WITH MANUFACTURER'S
 RECOMMENDED PARTS.
 AVERTISSEMENT: Δ IL INDIQUE LES COMPOSANTS CRITIQUES DE SÉCURITÉ.
 NE REMPLACER QUE DES PIÈCES RECOMMANDÉES PAR LE FABRICANT.

PCB T210A502C

2SA333S	2SB1425
2SC1740S	2SC2274K
DTA114	2SC3383
DTC114	2SD2159
DTC143	
DTC144	

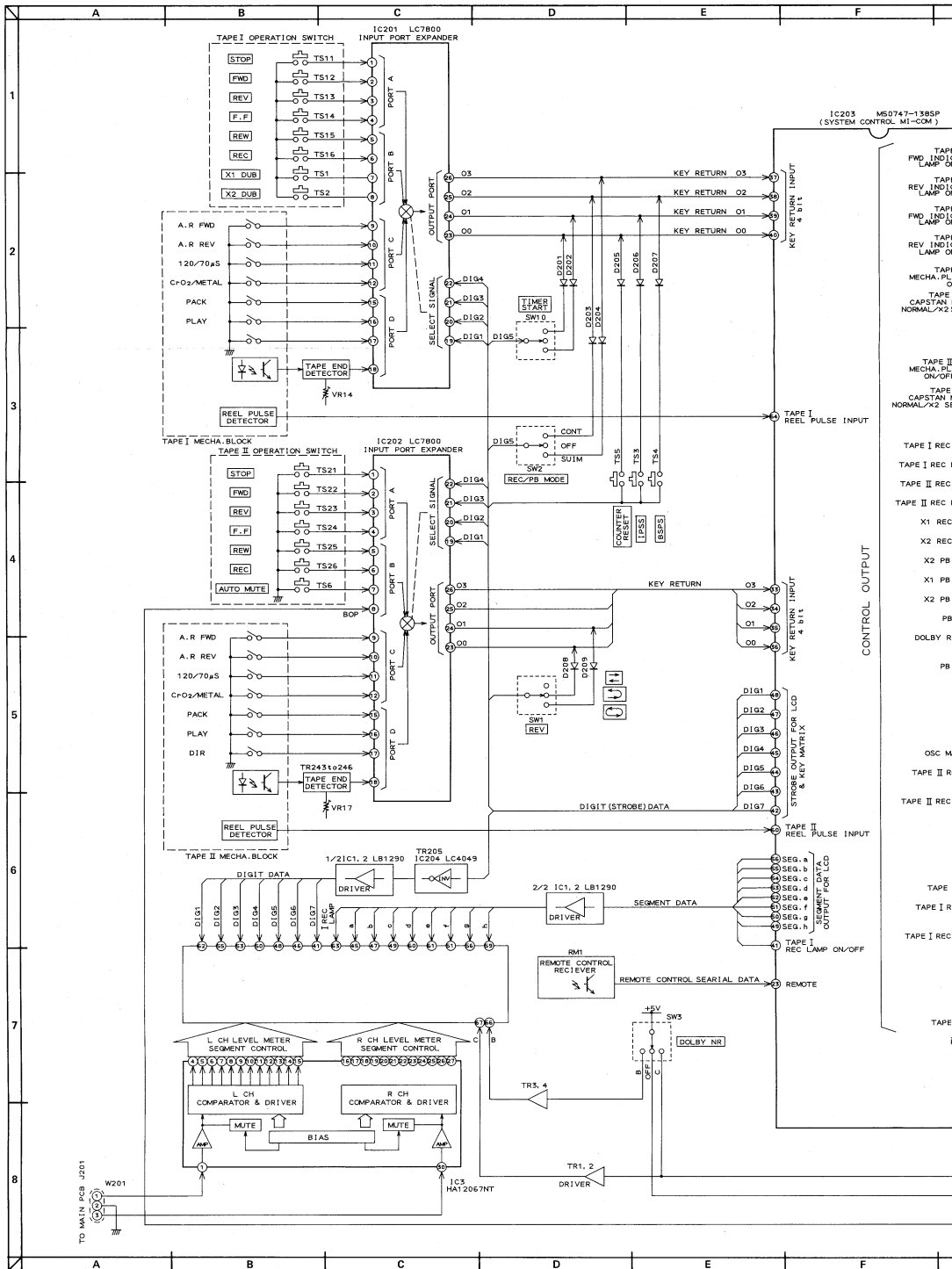

TO MAIN PCB J201

W201

IC3 HA12067NT

TR1.2 DRIVER

TR3.4

IC1.2 LB1290

TR205 1C2204 LC4049

1/2IC1.2 LB1290

TR243 to 246

BOP

IC202 LC7800 INPUT PORT EXPANDER

IC201 LC7800 INPUT PORT EXPANDER

IC203 ME0747-1385P (SYSTEM CONTROL MI-COM)

CONTROL OUTPUT

TAPE I INDIC LAMP ON
 TAPE I INDIC LAMP ON
 TAPE I INDIC LAMP ON
 TAPE I INDIC LAMP ON
 TAPE I MECHA. PLI ON/OFF
 TAPE I CAPSTAN M NORMAL/X2 SE
 TAPE II REC
 TAPE I REC
 TAPE II REC
 TAPE II REC
 X1 REC
 X2 REC
 X1 PB
 X2 PB
 PB
 DOLBY RE
 PB
 OSC MA
 TAPE I REC
 TAPE II REC
 TAPE I
 TAPE I REC
 TAPE I

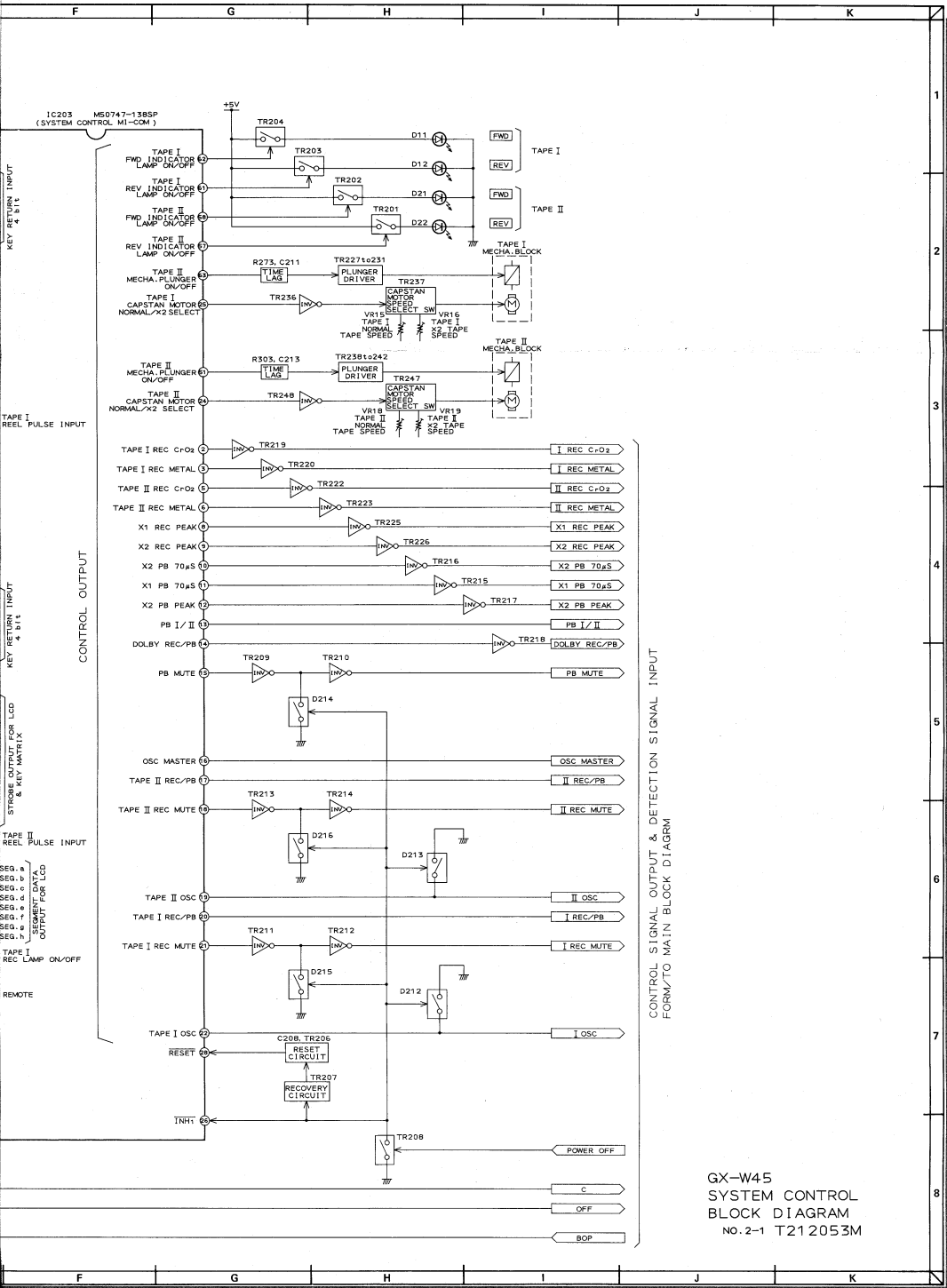

CONTROL SIGNAL OUTPUT & DETECTION SIGNAL INPUT
FORM/70 MAIN BLOCK DIAGRAM

GX-W45
SYSTEM CONTROL
BLOCK DIAGRAM
NO. 2-1 T212053M

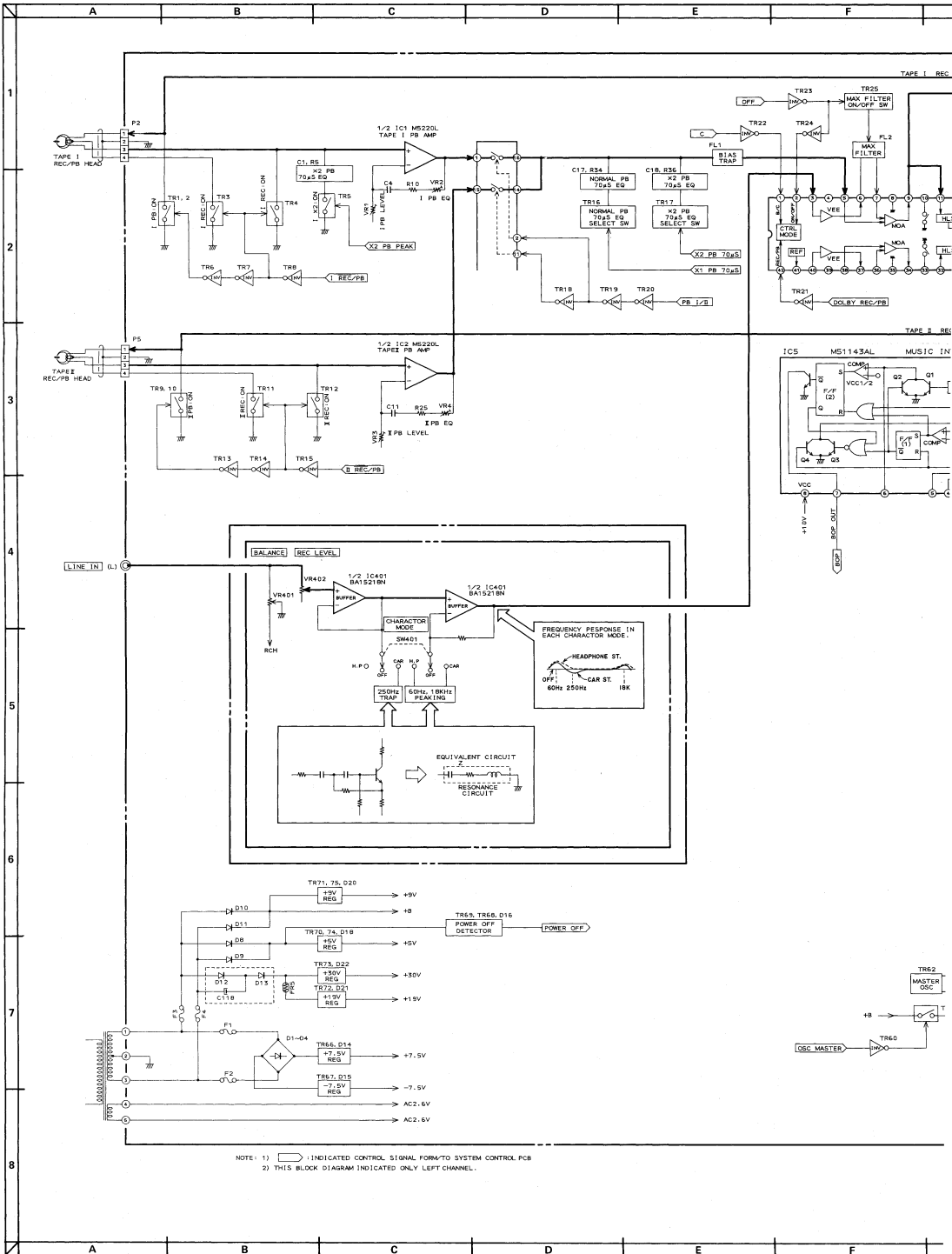

NOTE: 1) INDICATED CONTROL SIGNAL FROM TO SYSTEM CONTROL PCB
 2) THIS BLOCK DIAGRAM INDICATED ONLY LEFT CHANNEL.

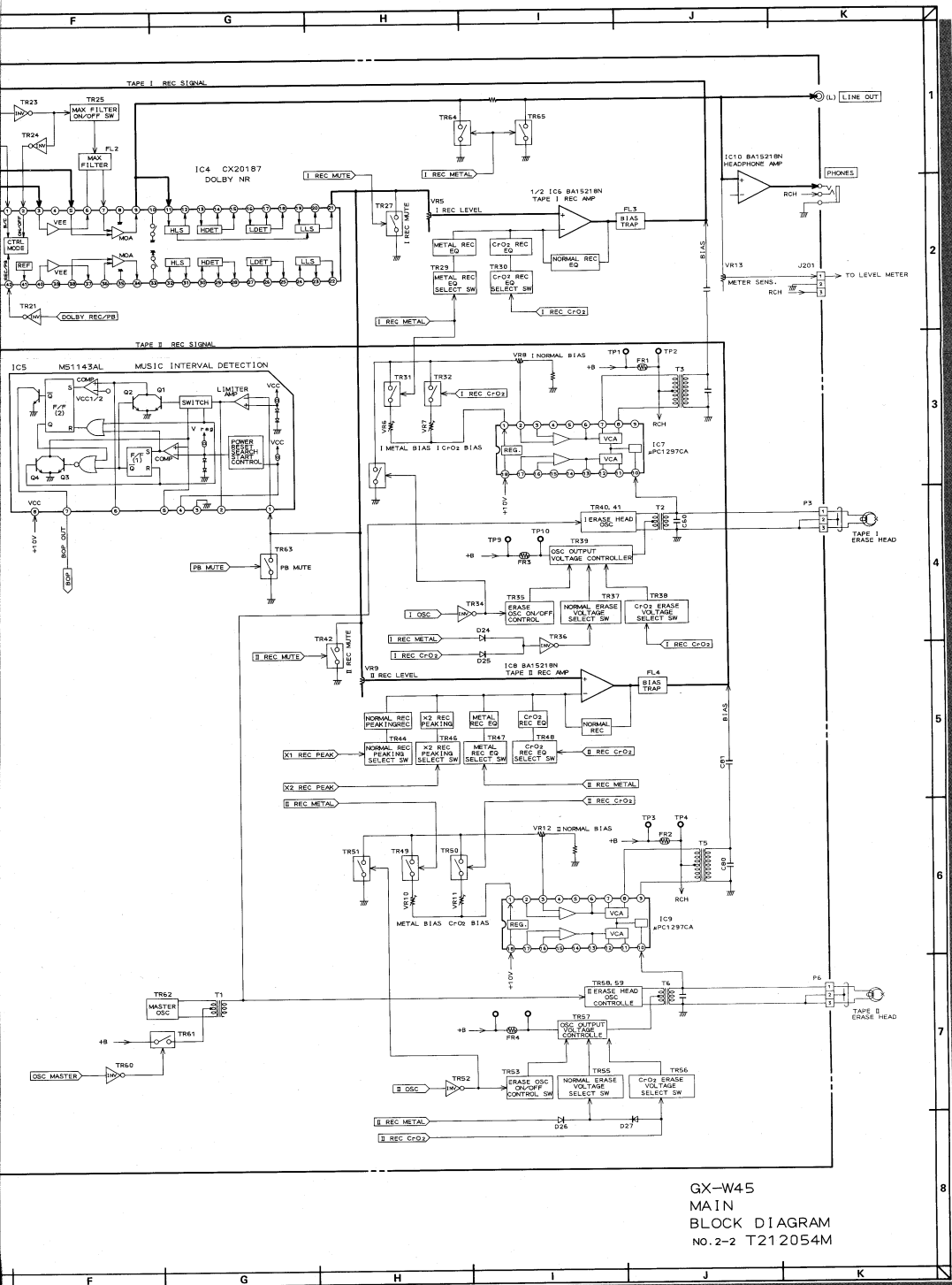

GX-W45
 MAIN
 BLOCK DIAGRAM
 NO. 2-2 T212054M

M50747-138SP (PORT ASSIGNMENT)

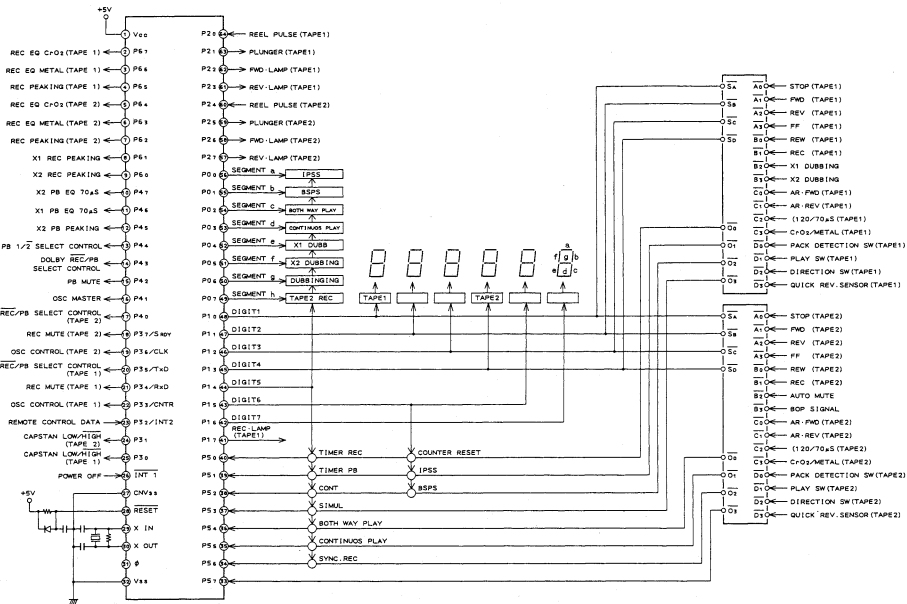

M51143AL (MUSIC)

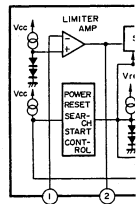

LC7800 (INPUT PORT)

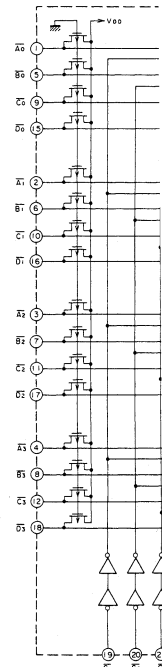

M51143AL (MUSIC INTERVAL DETECTION)

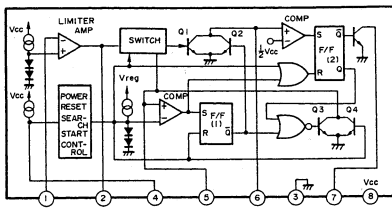

LC7800 (INPUT PORT EXPANDER)

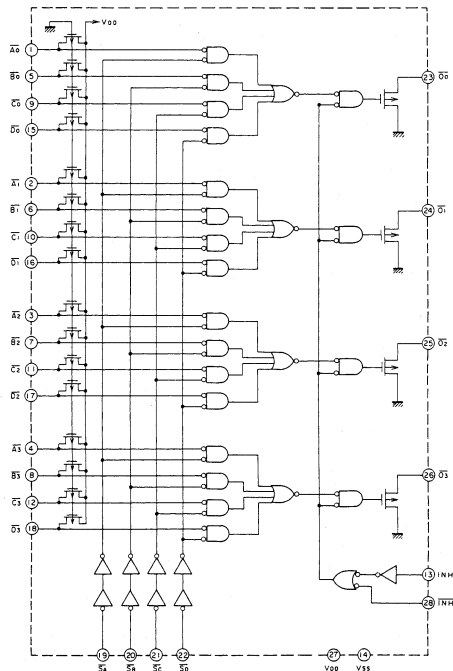

- A10 STOP (TAPE1)
- A11 PMD (TAPE1)
- A12 REV (TAPE1)
- A13 FF (TAPE1)
- B10 REV (TAPE1)
- B11 REC (TAPE1)
- B12 X1 DUBBING
- B13 X2 DUBBING
- C10 AR-PMD (TAPE1)
- C11 AR-REV (TAPE1)
- C12 (120/70AS (TAPE1)
- C13 C-D/METAL (TAPE1)
- D10 PACK DETECTION SW (TAPE1)
- D11 PLAY SW (TAPE1)
- D12 DIRECTION SW (TAPE1)
- D13 QUICK REV. SENSOR (TAPE1)
- A10 STOP (TAPE2)
- A11 PMD (TAPE2)
- A12 REV (TAPE2)
- A13 FF (TAPE2)
- B10 REV (TAPE2)
- B11 REC (TAPE2)
- B12 AUTO MUTE
- B13 BOP SIGNAL
- C10 AR-PMD (TAPE2)
- C11 AR-REV (TAPE2)
- C12 (120/70AS (TAPE2)
- C13 C-D/METAL (TAPE2)
- D10 PACK DETECTION SW (TAPE2)
- D11 PLAY SW (TAPE2)
- D12 DIRECTION SW (TAPE2)
- D13 QUICK REV. SENSOR (TAPE2)