

CS-F14

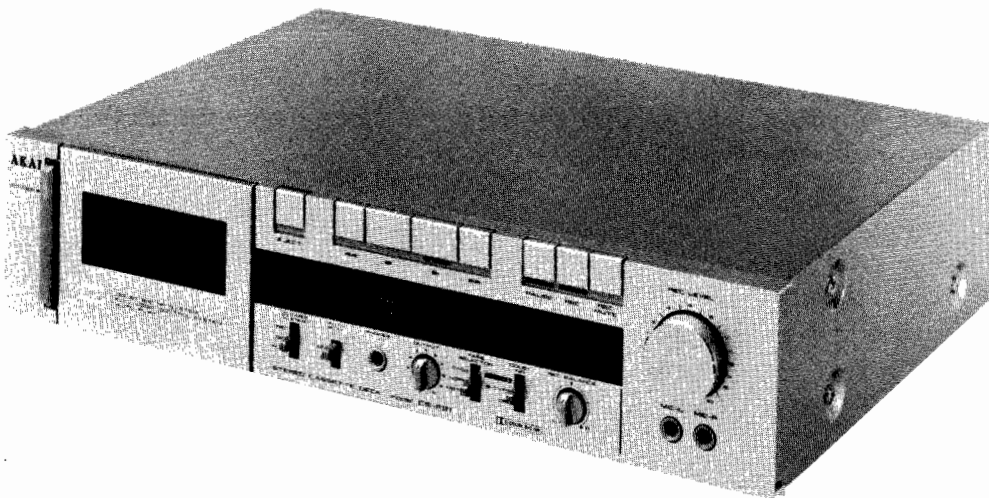

CS-F21

STEREO CASSETTE DECK

CS-F14 MODEL CS-F21

THIS MANUAL IS APPLICABLE TO BOTH SILVER AND BLACK PANEL MODELS

SECTION 1	SERVICE MANUAL	3
SECTION 2	PARTS LIST	25
SECTION 3	SCHEMATIC DIAGRAM	41

SAFETY INSTRUCTIONS

SAFETY CHECK AFTER SERVICING

Confirm the specified insulation resistance between power cord plug prongs and externally exposed parts of the set is greater than 10 Mohms, but for equipment with external antenna terminals (tuner, receiver, etc.) and is intended for **C** or **A**, specified insulation resistance should be more than 2.2 Mohms (ground terminals, microphone jacks, headphone jacks, line-in-out jacks etc.)

PRECAUTIONS DURING SERVICING

1. Parts identified by the **A** symbol parts are critical for safety.
Replace only with parts number specified.
2. In addition to safety, other parts and assemblies are specified for conformance with such regulations as those applying to spurious radiation. These must also be replaced only with specified replacements.
Examples: RF converters, tuner units, antenna selector switches, RF cables, noise blocking capacitors, noise blocking filters, etc.
3. Use specified internal wiring. Note especially:
 - 1) Wires covered with PVC tubing
 - 2) Double insulated wires
 - 3) High voltage leads
4. Use specified insulating materials for hazardous live parts. Note especially:
 - 1) Insulation Tape
 - 2) PVC tubing
 - 3) Spacers (Insulating Barriers)
 - 4) Insulation sheets for transistors
5. When replacing AC primary side components (transformers, power cords, noise blocking capacitors, etc.), wrap ends of wires securely about the terminals before soldering.

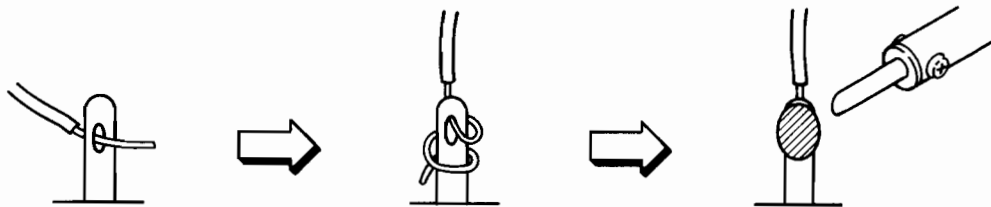

6. Observe that wires do not contact heat producing parts (heatsinks, oxide metal film resistors, fusible resistors, etc.).
7. Check that replaced wires do not contact sharp edged or pointed parts.
8. Also check areas surrounding repaired locations.
9. Use care that foreign objects (screws, solder droplets, etc.) do not remain inside the set.

SECTION 1

SERVICE MANUAL

TABLE OF CONTENTS

I. SPECIFICATIONS	4
II. DISMANTLING OF UNIT	5
III. CONTROLS	6
1. MODEL CS-F14	6
2. MODEL CS-F21	7
IV. PRINCIPAL PARTS LOCATION	8
1. MODEL CS-F14	8
2. MODEL CS-F21	9
V. VOLTAGE AND CYCLE CONVERSION	10
1. VOLTAGE CONVERSION	10
2. CYCLE CONVERSION	10
VI. MECHANICAL AND HEAD ADJUSTMENT	11
1. VARIOUS TORQUE MEASUREMENT	11
2. TAPE SPEED ADJUSTMENT	11
3. RECORDING/PLAYBACK HEAD AZIMUTH ALIGNMENT	11
VII. AMPLIFIER ADJUSTMENT	12
VIII. DC RESISTANCE OF VARIOUS COILS	14
IX. CLASSIFICATION OF VARIOUS P.C BOARDS	14
1. P.C BOARD TITLES AND IDENTIFICATION NUMBER	14
2. COMPOSITION OF VARIOUS P.C BOARDS	15

For basic adjustments, measuring methods, and operating principles, refer to GENERAL TECHNICAL MANUAL.

I . SPECIFICATIONS

TRACK SYSTEM	4 Track 2 Channel Stereo System
TAPE	Philips Type Cassette
TAPE SPEED	4.76 cm/s \pm 1.0% (1-7/8 ips. \pm 1.0%)
HEADS	High Density Metallic Head for recording/ playback \times 1 Erase Head \times 1
MOTOR	Electronically speed controlled DC motor
WOW & FLUTTER	Less than 0.04% WRMS, 0.10% (DIN 45500)
TAPE WINDING TIME	90 sec. using a C-60 cassette tape
FREQUENCY RESPONSE	Normal: 30 to 15,000 Hz \pm 3 dB (-20 VU) 20 to 17,000 Hz CrO ₂ : 30 to 16,000 Hz \pm 3 dB (-20 VU) 20 to 18,000 Hz Metal: 30 to 18,000 Hz \pm 3 dB (-20 VU) 20 to 19,000 Hz
SIGNAL TO NOISE RATIO	Normal: Better than 56 dB CrO ₂ : Better than 58 dB Metal: Better than 58 dB (measured via tape with peak recording level) Dolby C-type NR ON: Improves up to 15 dB at 500 Hz, 20 dB at 1 kHz to 10 kHz Dolby B-type NR ON: Improves up to 5 dB at 1 kHz, 10 dB above 5 kHz
HARMONIC DISTORTION	Normal: Less than 0.8% CrO ₂ : Less than 0.8% Metal: Less than 0.8%
INPUT	MIC: 0.25 mV (input impedance 5.0 kohms) Required microphone impedance: 600 ohms Line: 70 mV (input impedance 47 kohms)
OUTPUT	Line: 410 mV at 0 VU Required load impedance: more than 20 kohms phone: 0.3 mV/8 ohms at 0 VU
DIN	Input: 2.0 mV (input impedance 10 kohms) Output: 410 mV Required load impedance: more than 20 kohms
POWER REQUIREMENT	AC 120V, 60 Hz for USA and Canada AC 220V, 50 Hz for Europe except UK AC 240V, 50 Hz for UK and Australia AC 110V/120V/220V/240V, 50/60 Hz switchable for other countries,
POWER CONSUMPTION	15W C 16W A 14W U
DIMENSIONS	440 (W) \times 103 (H) \times 273 (D) mm (17.3 \times 4.1 \times 10.7 inches)
WEIGHT	4.1 kg (9.1 lbs)

* For improvement purposes, specifications and design are subject to change without notice.

**“Dolby” and the Double D symbol are trademarks of Dolby Laboratories

(Manufactured under license from Dolby Laboratories.)

II. DISMANTLING OF UNIT

In case of trouble, etc. necessitating dismantling, please dismantle in the order shown in the photographs. Reassemble in reverse order.

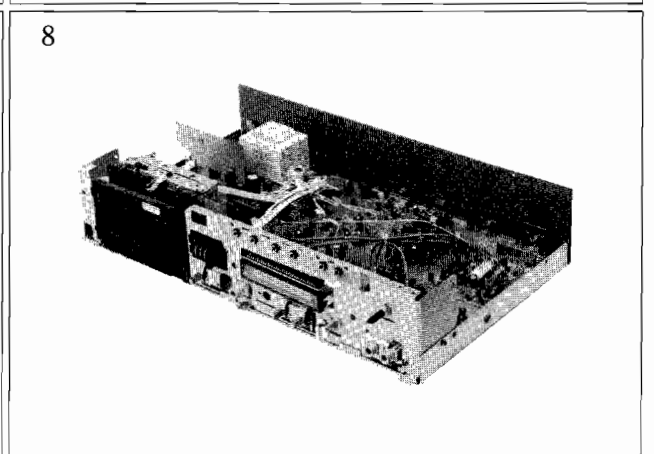
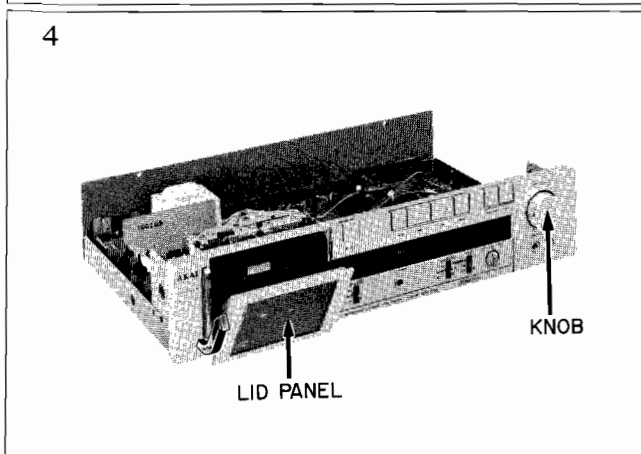
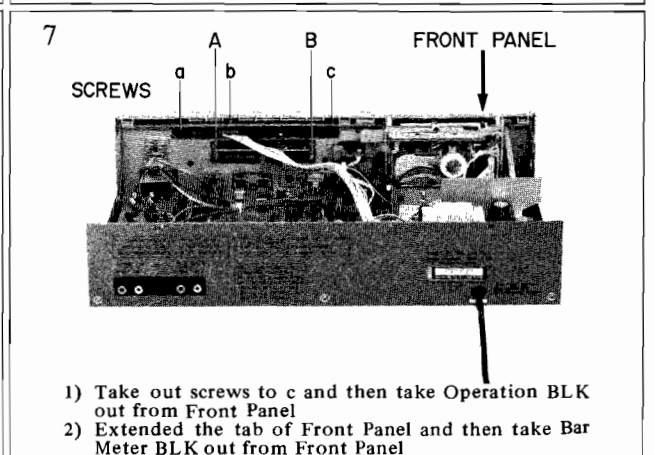
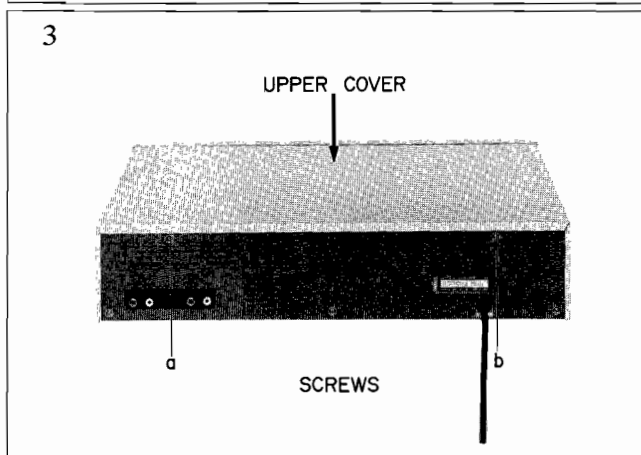
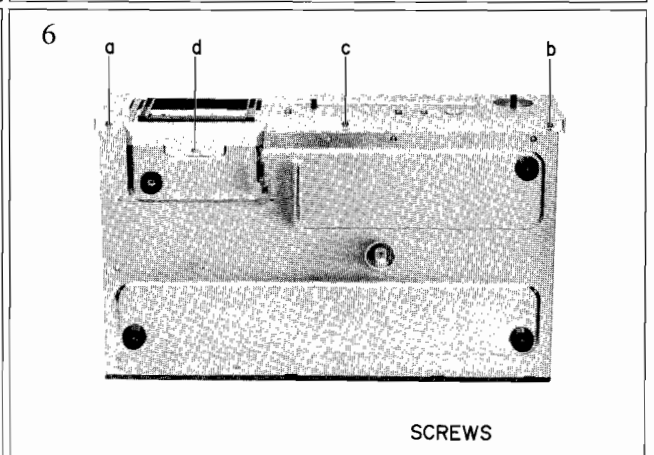
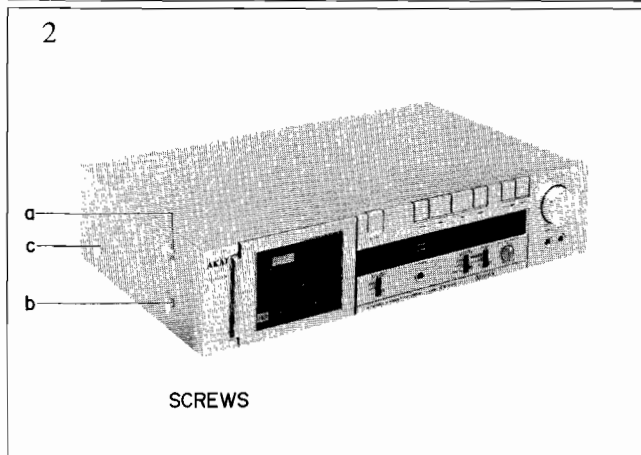
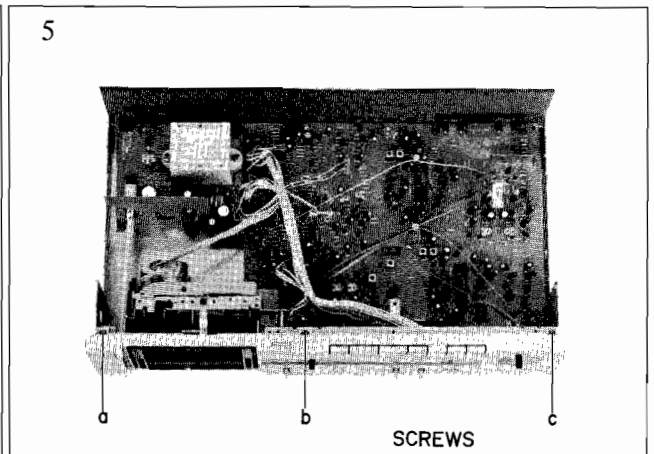
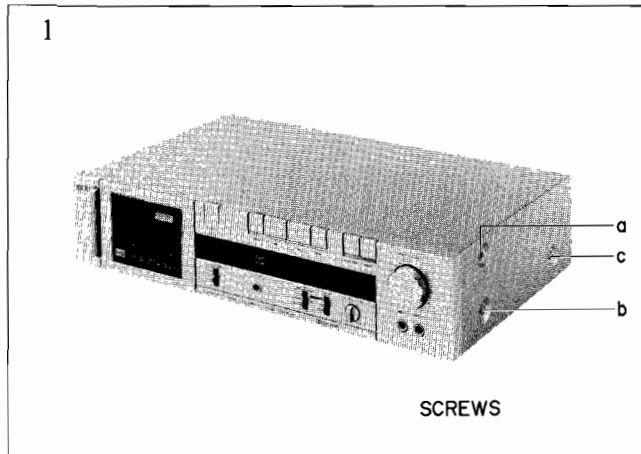

III. CONTROLS

1. MODEL CS-F14

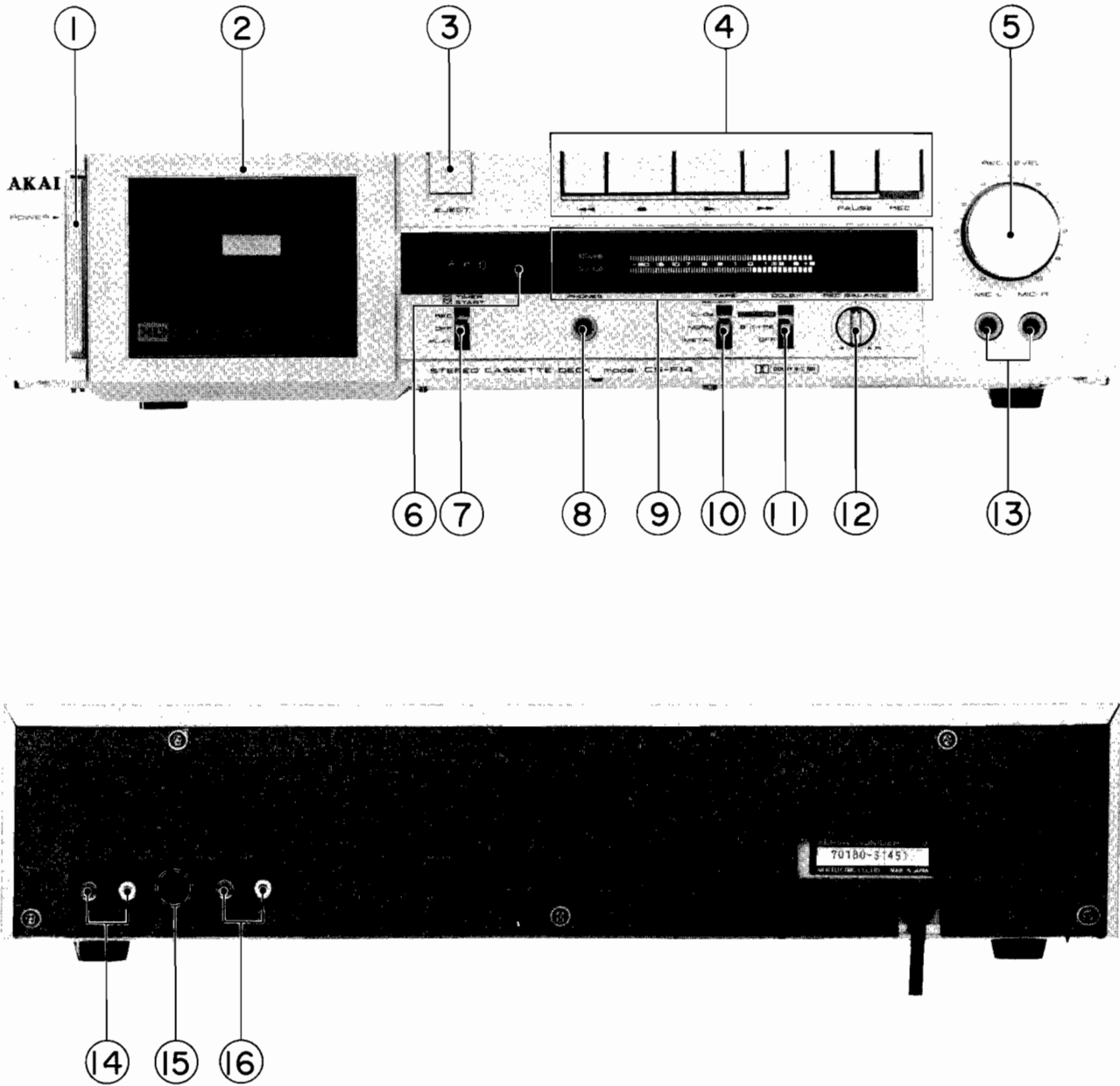

Fig. 1 Controls (CS-F14)

- | | |
|--|---|
| 1. POWER SWITCH | 9. FLD BAR METER |
| 2. CASSETTE RECEPTACLE | 10. TAPE SELECTOR |
| 3. EJECT BUTTON | 11. DOLBY NR SELECTOR |
| 4. OPERATION BUTTONS | 12. RECORDING (REC) BALANCE CONTROL |
| 5. RECORDING LEVEL CONTROL (REC LEVEL) | 13. MICROPHONE JACKS (MIC-L: Left, MIC-R: Right) |
| 6. TAPE COUNTER AND RESET BUTTON | 14. LINE IN JACKS (RIGHT and LEFT) |
| 7. TIMER START SWITCH | 15. DIN JACK (Some models do not have this facility.) |
| 8. HEADPHONE JACK (PHONES) | 16. LINE OUT JACKS (RIGHT and LEFT) |

2. MODEL CS-F21

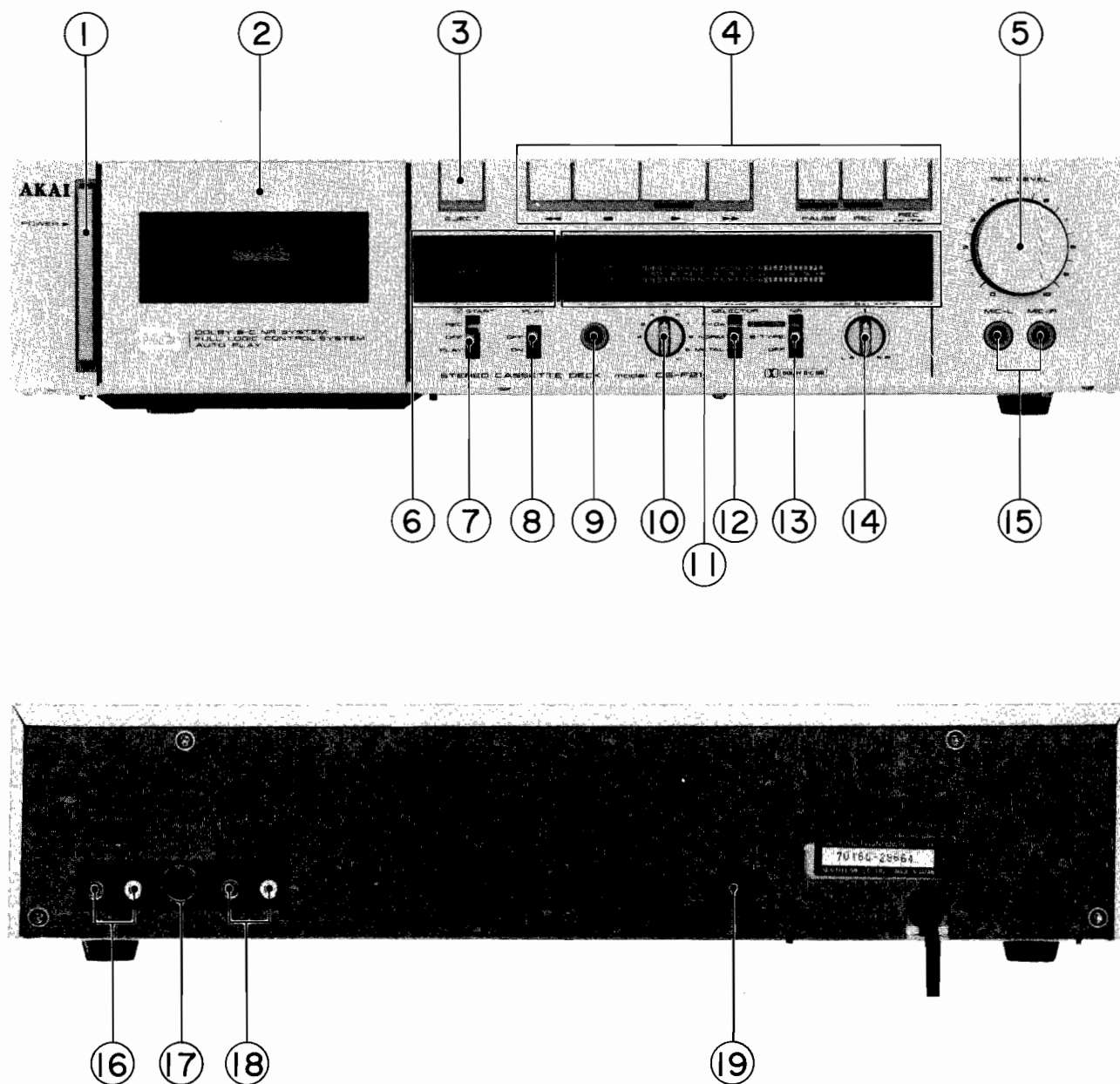

Fig. 2 Controls (CS-F21)

- | | |
|--|---|
| 1. POWER SWITCH | 11. FLD BAR METER |
| 2. CASSETTE RECEPTACLE | 12. TAPE SELECTOR |
| 3. EJECT BUTTON | 13. DOLBY NR SELECTOR |
| 4. OPERATION BUTTONS | 14. RECORDING (REC) BALANCE CONTROL |
| 5. RECORDING LEVEL CONTROL (REC LEVEL) | 15. MICROPHONE JACKS (MIC-L: Left, MIC-R: Right) |
| 6. TAPE COUNTER AND RESET BUTTON | 16. LINE IN JACKS (RIGHT and LEFT) |
| 7. TIMER START SWITCH | 17. DIN JACK (Some models do not have this facility.) |
| 8. AUTO PLAY SWITCH | 18. LINE OUT JACKS (RIGHT and LEFT) |
| 9. HEADPHONE JACK (PHONES) | 19. REMOTE CONTROL JACK |
| 10. OUTPUT CONTROL | |

IV. PRINCIPAL PARTS LOCATION

1. MODEL CS-F14

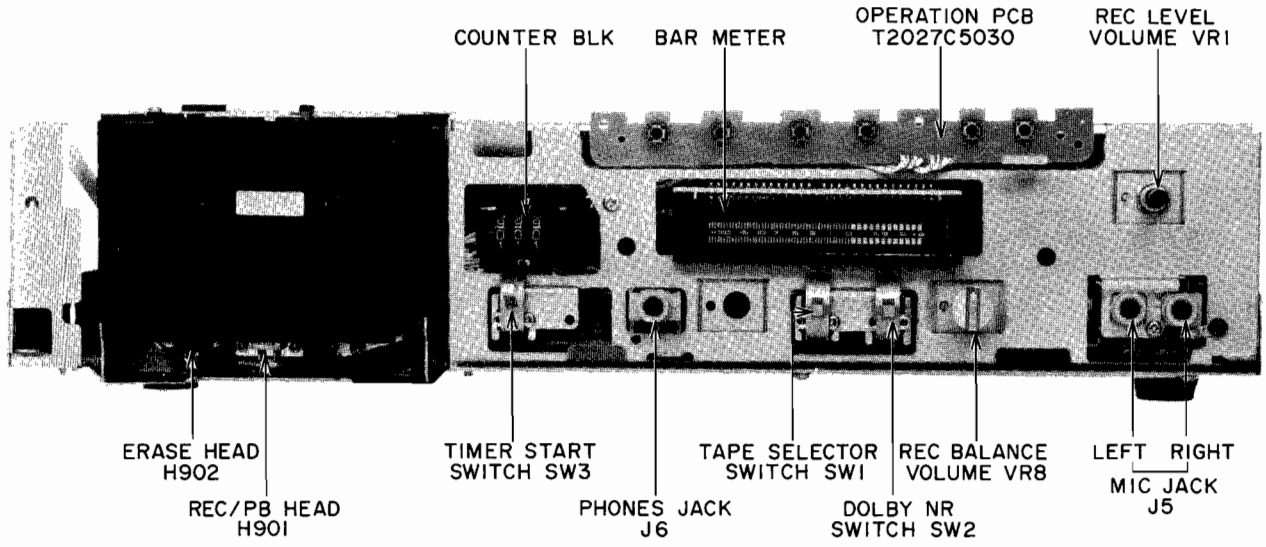

Fig. 3 Front View

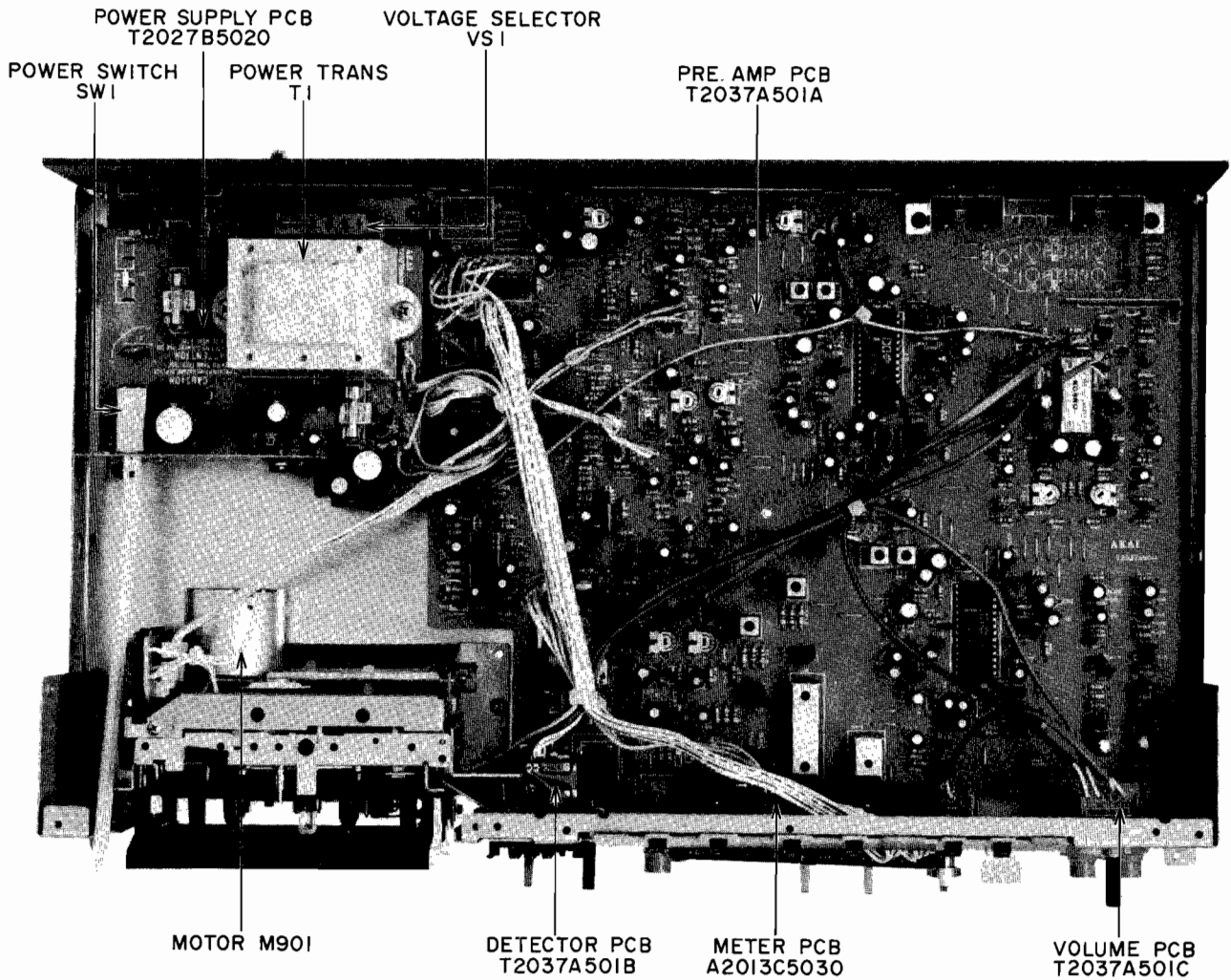

Fig. 4 Top View

2. MODEL CS-F21

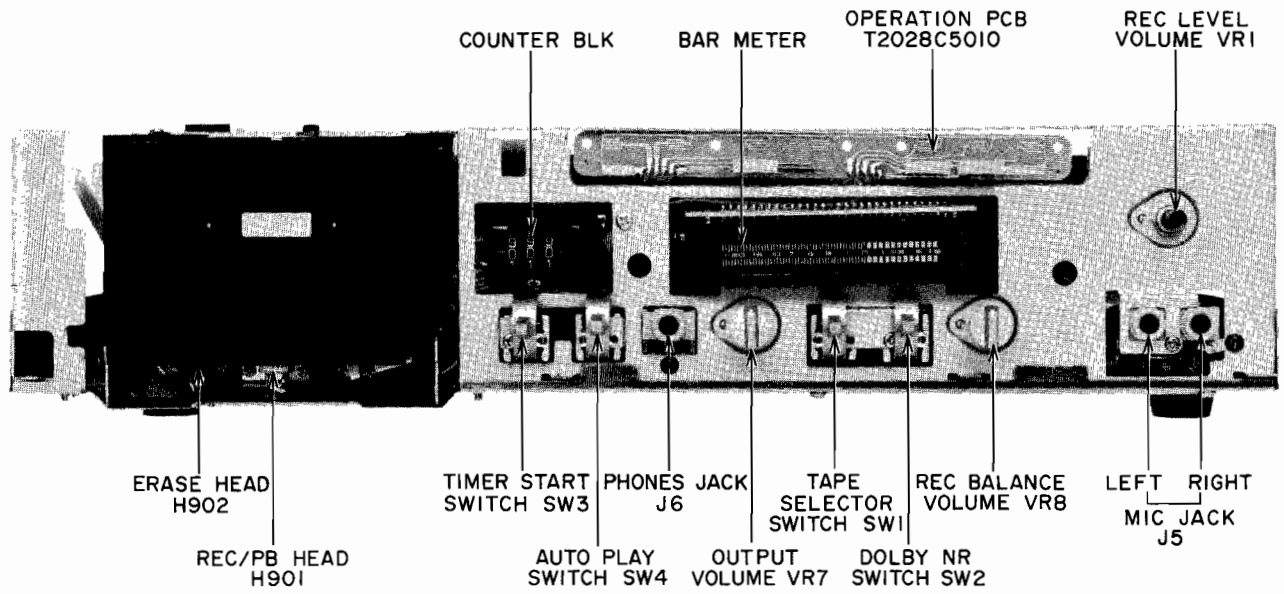

Fig. 5 Front View

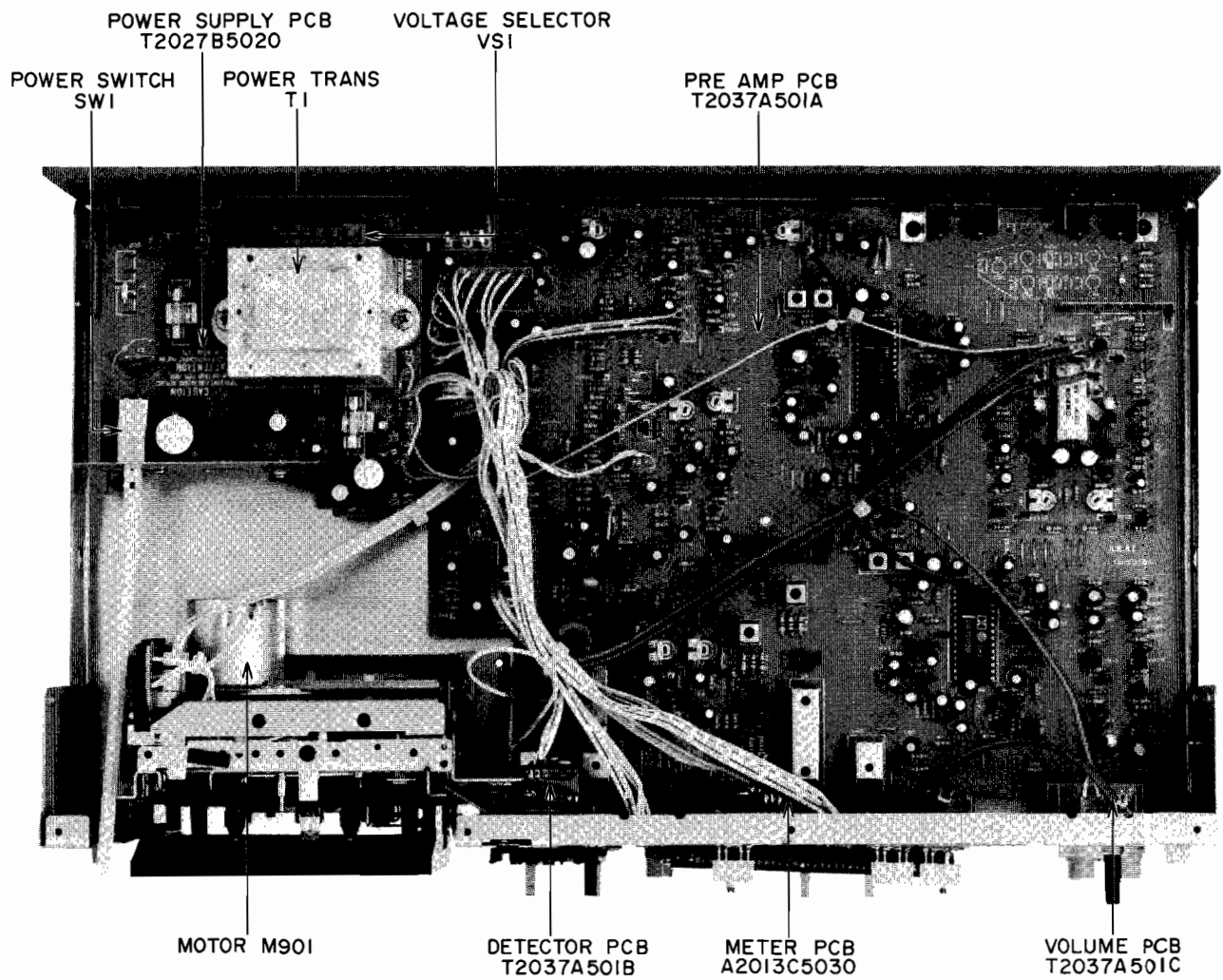

Fig. 6 Top View

V. VOLTAGE AND CYCLE CONVERSION

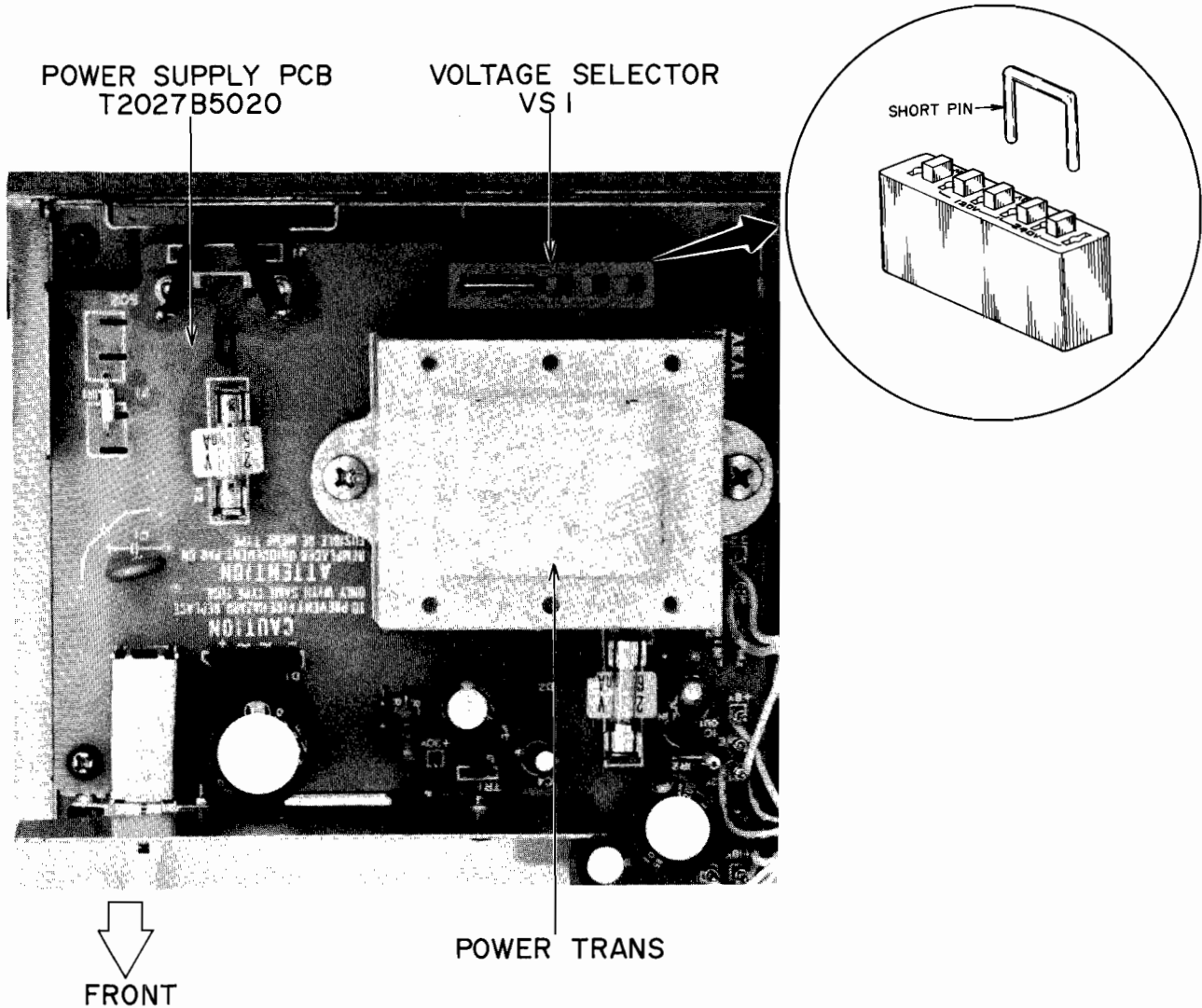

Fig. 7 Voltage Conversion (U/T Model only)

1. VOLTAGE CONVERSION

Models for Canada, Europe, USA, UK and Australia are not equipped with this facility.

Each machine is preset at the factory according to destination, but some machines can be set to 110V, 120V, 220V or 240V as required.

If voltage change is necessary, this can be accomplished as follows:

- 1) Disconnect power cord.
- 2) Loosen holding screws and remove upper cover.
- 3) Remove short pin plug from present holes and replace in correct holes. Follow the markings explicitly.

2. CYCLE CONVERSION

With DC motor, cycle conversion is not necessary.

VI. MECHANICAL AND HEAD ADJUSTMENT

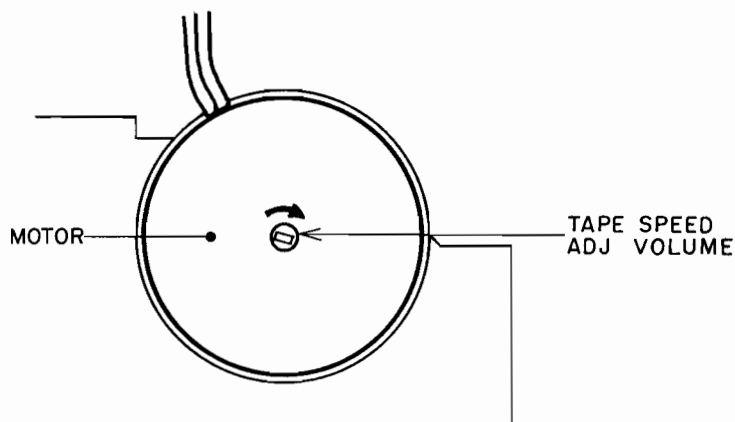

Fig. 8 Tape Speed Adjustment

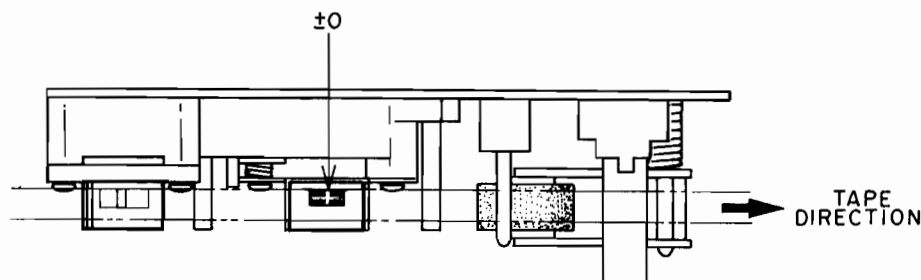
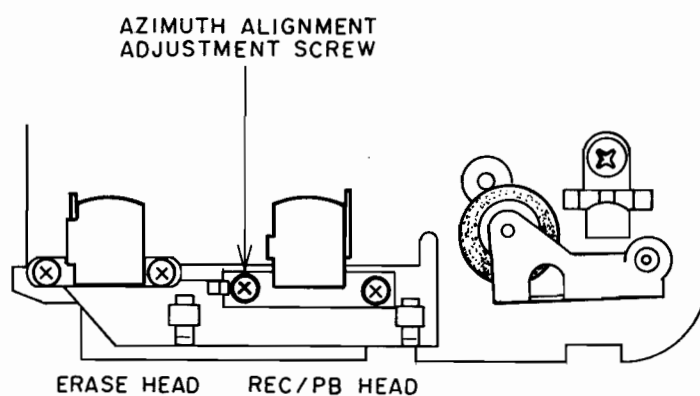

Fig. 9 Head Adjustment

1. VARIOUS TORQUE MEASUREMENT

Use the Cassette Torque Meter (TF-110CT) to confirm that the value of each mode is as follows:

- Take up Torque : 35 to 70 g-cm
- FF/RWD Torque : 70 to 150 g-cm

2. TAPE SPEED ADJUSTMENT

(Refer to Fig. 8)

Playback a 1,000 Hz pre-recorded test tape (TF-102CS) and adjust the tape speed adjustment volume to obtain a tape speed of 1,000 Hz \pm 5 Hz.

3. RECORDING/PLAYBACK HEAD

AZIMUTH ALIGNMENT (Refer to Fig. 9)

a) Playback a 10 kHz pre-recorded cassette azimuth alignment test tape (TF-106CH) and adjust screw shown in Fig. 9 to obtain maximum output on

both channels.

b) Invert cassette and confirm that the output level does not change from that obtained in Item 3-a) above.

If the output level differs, adjust in the same way as in Item 3-a) above until both sides of the test tape display equal output.

NOTES:

1. Be sure to clean the heads prior to head adjustment.
2. Be careful not to use a magnetized driver or other magnetized tools in the vicinity of the heads.
3. Be sure to demagnetize the heads with a Head Demagnetizer before and after head adjustment.

VII. AMPLIFIER ADJUSTMENT

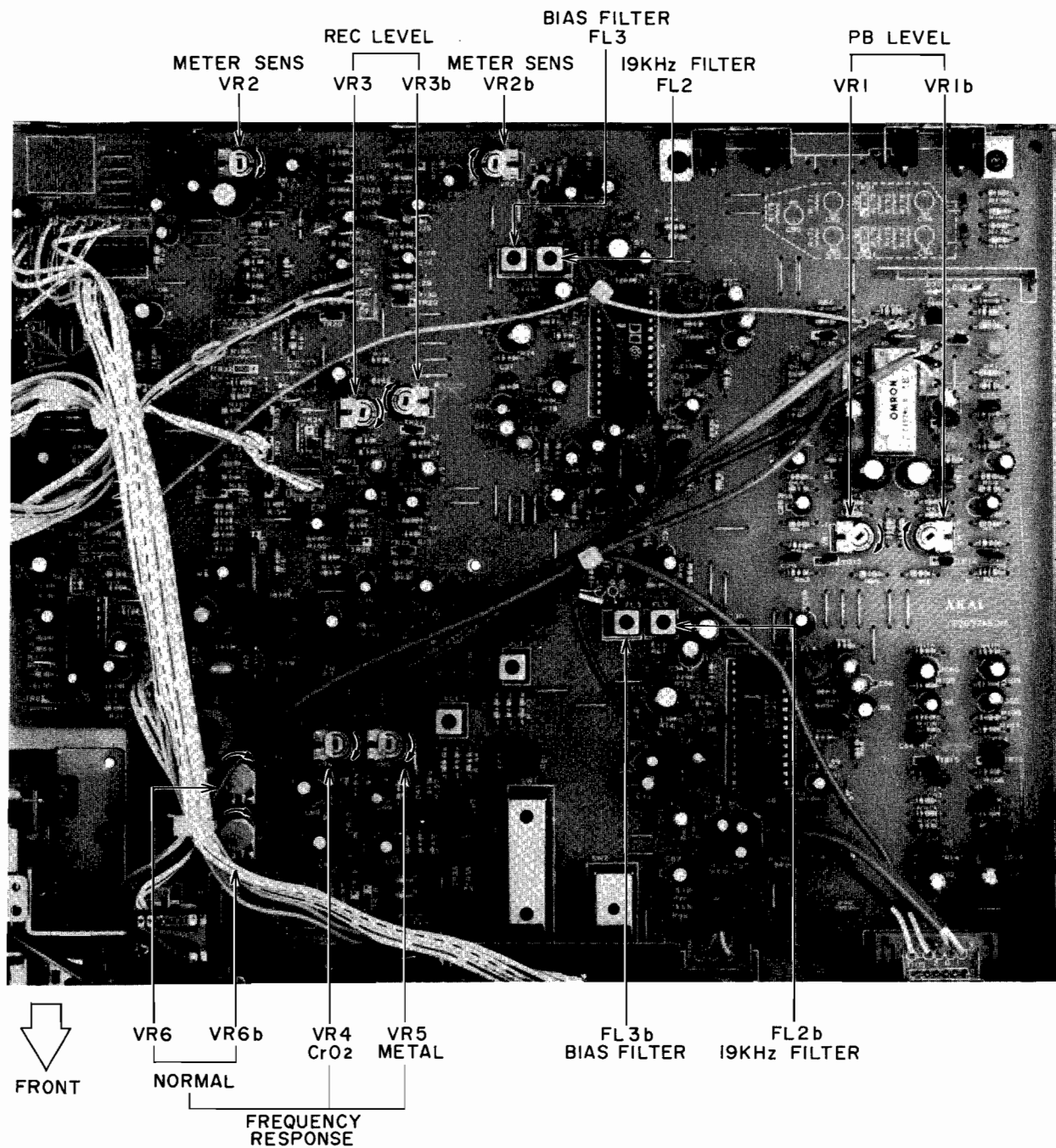

Fig. 10 Pre Amp P.C Board (Parts Side View)

STEP	ADJUSTMENT ITEM	TEST TAPE SUPPLY SIGNAL	MODE	ADJUSTMENT PARTS	RESULT	REMARKS
1	PB Level	333 Hz (TF-101CL)	PB	VR1 50 kohms	-5.5 ± 0.2 dBm (410 mV)	Set Tape Selector Switch to NORMAL
2	Normal Position Frequency Response	Normal Blank Tape 1 kHz, 10 kHz -25.5 dBm	REC/PB	VR6 100 kohms	1 kHz to 10 kHz flat response	
3	CrO ₂ Position Frequency Response	CrO ₂ Blank Tape 1 kHz, 10 kHz -25.5 dBm	REC/PB	VR4 10 kohms	1 kHz to 10 kHz flat response	Set Tape Selector Switch to CrO ₂
4	Metal Position Frequency Response	Metal Blank Tape 1 kHz, 10 kHz -25.5 dBm	REC/PB	VR5 3 kohms	1 kHz to 10 kHz flat response	Set Tape Selector Switch to METAL
5	REC Level	Normal Blank Tape 1 kHz, -5.5 dBm	REC/PB	VR3 20 kohms	-5.5 ± 0.5 dBm (410 mV)	Set Tape Selector Switch to NORMAL
6	19 kHz Filter	19 kHz from oscillator	REC	FL2	Minimum Output	Set Dolby NR Switch to B-TYPE or C-TYPE
7	Bias Filter	No Signal Input	REC	FL3	Minimum Output	Set Tape Selector Switch to METAL Set REC Volume to maximum
8	Meter Sensitivity	1 kHz, -5.5 dBm from oscillator	REC	VR2 30 kohms	0dB indication	Extingnished +1 VU when -5.2 dBm

- NOTES: 1. Except for step 6 set Dolby NR Switch to OFF Position.
2. Use the following cassette measuring tapes:
Normal Tape : Maxell UD C-60
CrO₂ Tape : TDK SA C-60
Metal Tape : TDK MA-C C-60
3. As Dolby B-C uses 1 chip IC HA12038, adjustment is unnecessary.

VIII. DC RESISTANCE OF VARIOUS COILS

DESCRIPTION	DC RESISTANCE
REC/PB Head	210 ohms \pm 20%
Erase Head	3.5 ohms
Plunger Solenoid (FF, REW, PLAY)	75 ohms \pm 10%

IX. CLASSIFICATION OF VARIOUS P.C BOARDS

1. P.C BOARD TITLES AND IDENTIFICATION NUMBER

P.C BOARD TITLE	P.C BOARD NUMBER
Pre Amp P.C Board	T2037A501A
Detector P.C Board	T2037A501B
Volume P.C Board	T2037A501C
Power Supply P.C Board	T2027B5020
Operation P.C Board (CS-F14)	T2027C5030
Operation P.C Board (CS-F21)	T2028C5010
Meter P.C Board	A2013C5030

2. COMPOSITION OF VARIOUS P.C BOARDS

1) Pre Amp P.C Board T2037A501A (2ED), Detector P.C Board T2037A501B, Volume P.C Board T2037A501C (Model CS-F14)

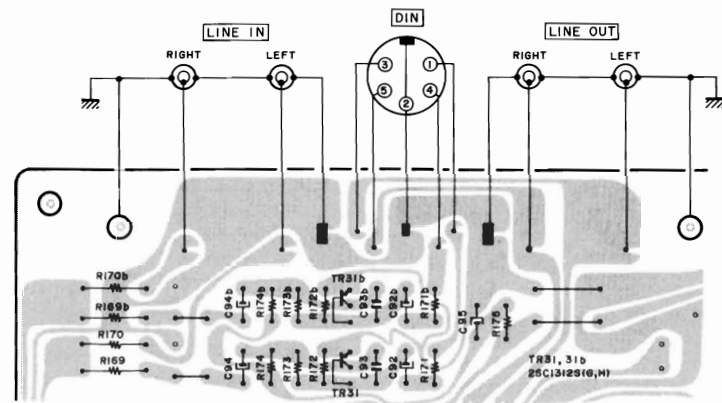

LOCATION OF MAIN COMPONENTS

IC 1-----F1
IC 2, 3-----F3
IC 4-----C2
IC 4b-----B4

TR 1, 2-----E1
TR 3-----E2
TR 4 to 6-----F2
TR 8-----F4
TR 10, 11-----B2
TR 12-----B3
TR 13-----C3
TR 14-----A5
TR 15-----A4
TR 16-----C1
TR 17-----D5
TR 19-----E1
TR 20, 21-----E2
TR 22-----D3
TR 23, 24-----E4
TR 25 to 29-----E3
TR 30-----A2
TR 33-----E2
TR 35-----D5
TR 36-----B2

① to ⑨-----F2
⑩, ⑪-----E5
⑫, ⑬-----F2
⑭ to ⑰-----F1
⑱ to ⑲-----D1
⑳ to ㉑-----E3
㉒ to ㉒-----F4
㉓ to ㉓-----B5
㉔ to ㉔-----A2
㉕, ㉕-----C1
㉖, ㉖-----C2

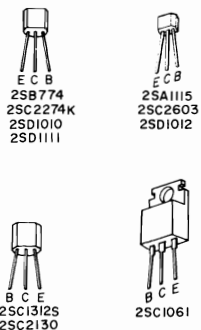

TR1, 2-----25B774 (G, R, S)
TR3, 8, 12, 19, 20, 22, 25, 27, 28, 33, 34, 36-----25C2603 (E, F)
TR4 to 6-----25D1111
TR10, 11, 14, 16, 31-----25C1312S (G, H)
TR13, 23, 24-----25C2274K (E, F)
TR17, 29-----25A1115 (E, F)
TR21-----25D1012-V (F, G)
TR26-----25C1061 (C, D)
TR35-----25D1010 (R, S)
TR36-----25C2130 (G, H)

VOLUME PCB T2037A501C

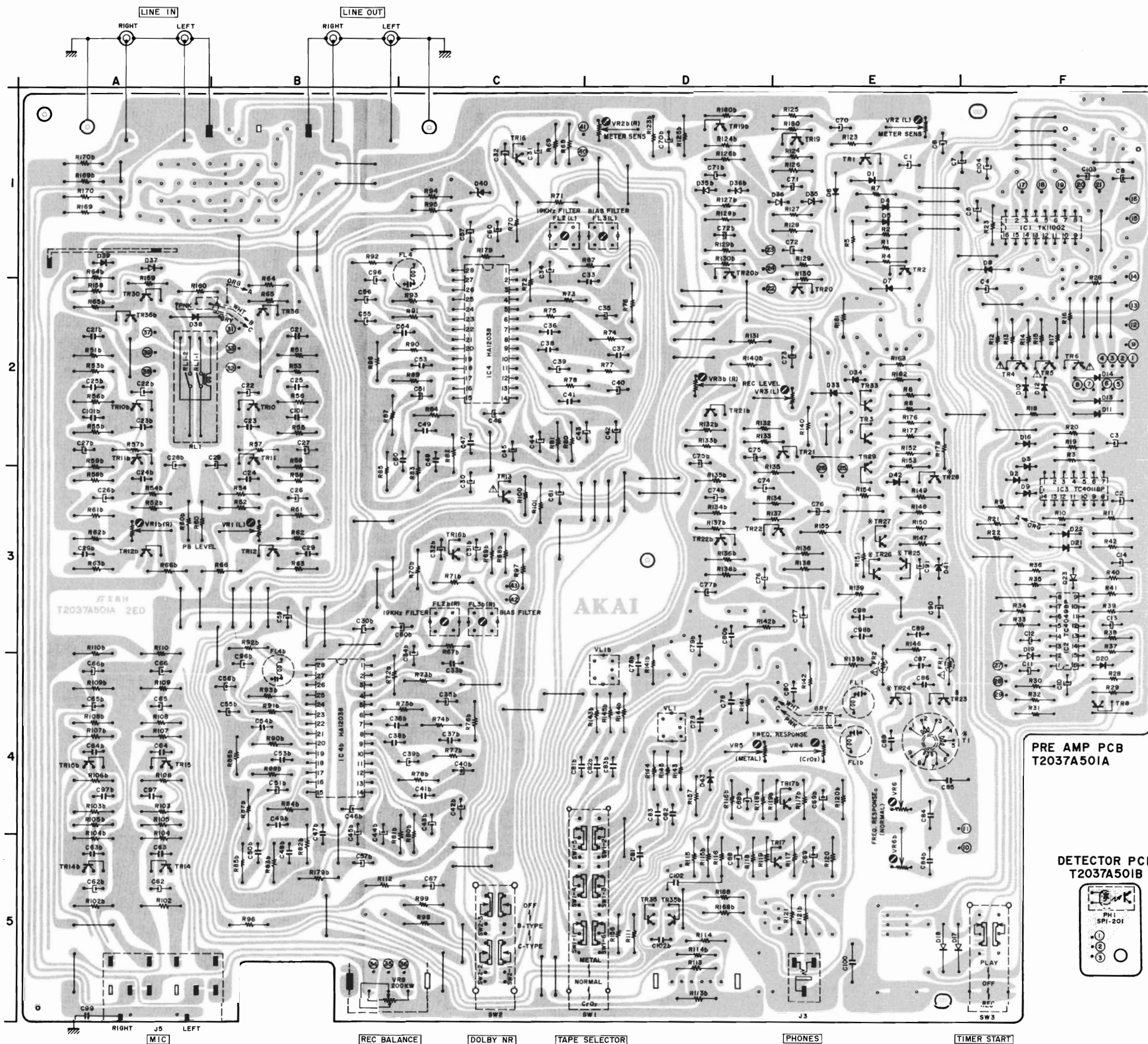
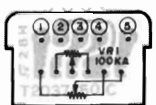

PRE AMP PCB T2037A501A

DETECTOR PCB T2037A501B

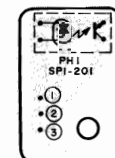

WARNING: Δ INDICATES SAFETY CRITICAL COMPONENTS. FOR CONTINUED SAFETY, REPLACE SAFETY CRITICAL COMPONENTS ONLY WITH MANUFACTURER'S RECOMMENDED PARTS

AVERTISSEMENT: Δ IL INDIQU LES COMPOSANTS CRITIQUES DE SÛRETÉ. POUR MAINTENIR LE DEGRÉ DE SÛRETÉ DE L'APPAREIL, NE REMPLACER LES COMPOSANTS DONT LE FONCTIONNEMENT EST CRITIQUE POUR LA SÛRETÉ QUE PAR DES PIÈCES RECOMMANDÉES PAR LE FABRICANT

2) Pre Amp P.C Board T2037A501A (2ED), Detector P.C Board T2037A501B, Volume P.C Board T2037A501C (Model CS-F21)

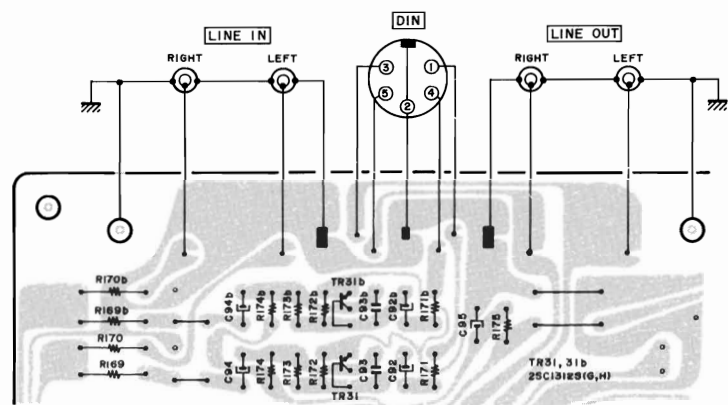

LOCATION OF MAIN COMPONENTS

- IC 1 -----F1
- IC 2, 3 -----F3
- IC 4 -----C2
- IC 4b -----B4

- TR 1, 2 -----E1
- TR 3 -----E2
- TR 4 to 6 -----F2
- TR 7 -----F1
- TR 8 -----F4
- TR 10, 11 -----B2
- TR 12 -----B3
- TR 13 -----C3
- TR 14 -----A5
- TR 15 -----A4
- TR 16 -----C1
- TR 17 -----D5
- TR 19 -----E1
- TR 20, 21 -----E2
- TR 22 -----D3
- TR 23, 24 -----E4
- TR 25 to 29 -----E3
- TR 30 -----A2
- TR 32 to 34 -----
- TR 33 -----E2
- TR 35 -----D5
- TR 36 -----B2

- ① to ⑨ -----F2
- ⑩, ⑪ -----E5
- ⑫, ⑬ -----F2
- ⑭ to ⑰ -----F1
- ⑱ to ⑲ -----D1
- ⑳ to ㉑ -----E3
- ㉒ to ㉒ -----F4
- ㉓ to ㉓ -----B2
- ㉔ to ㉔ -----B5
- ㉕ to ㉕ -----A2
- ㉖, ㉖ -----C1
- ㉗, ㉗ -----C2
- ㉘ to ㉘ -----F1

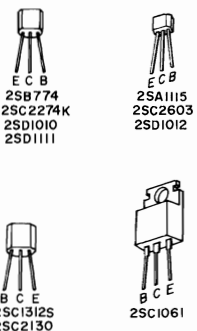

- TR 1, 2 ---- 25B774 (Q, R, S)
- TR 3, 6, 12, 19, 20, 22, 25, 27, 28, 32 to 34, 36 --- 25C2603 (E, F)
- TR 4 to 6 --- 25D1111
- TR 7, 30 --- 25C2130 (G, H)
- TR 10, 11, 14 to 16, 31 --- 25C13125 (G, H)
- TR 13, 23, 24 --- 25C2274K (E, F)
- TR 17, 29 --- 25A1115 (E, F)
- TR 21 --- 25D1015 (V, F, G)
- TR 26 --- 25C1016 (C, D)
- TR 35 --- 25D1010 (R, S)

VOLUME PCB T2037A501C

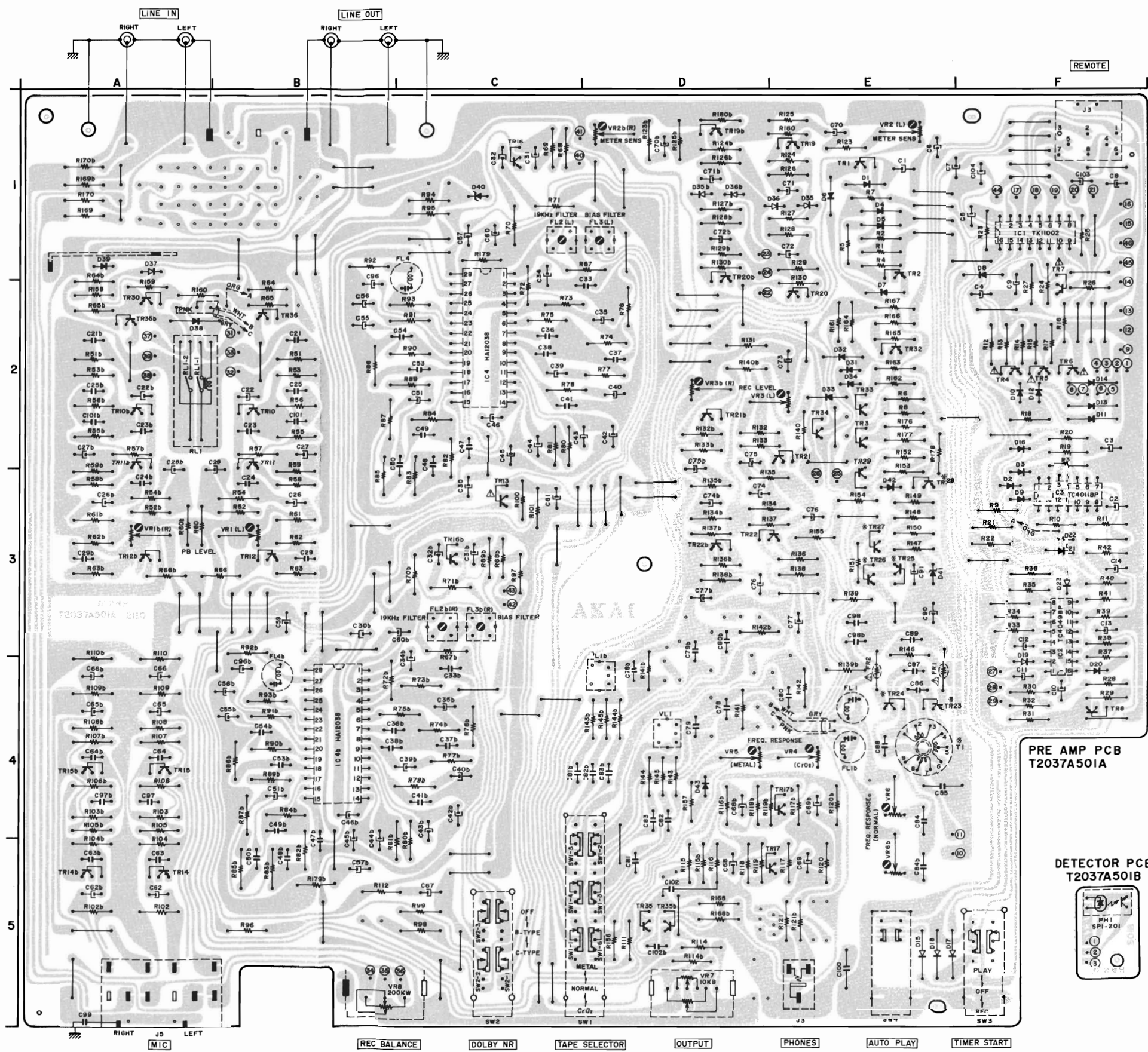
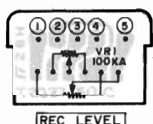

PRE AMP PCB T2037A501A

DETECTOR PCB T2037A501B

WARNING: Δ INDICATES SAFETY CRITICAL COMPONENTS. FOR CONTINUED SAFETY, REPLACE SAFETY CRITICAL COMPONENTS ONLY WITH MANUFACTURER'S RECOMMENDED PARTS.
 AVERTISSEMENT: Δ IL INDIQUE LES COMPOSANTS CRITIQUES DE SÛRETÉ. POUR MAINTENIR LE DEGRÉ DE SÛRETÉ DE L'APPAREIL NE REMPLACER LES COMPOSANTS DONT LE FONCTIONNEMENT EST CRITIQUE POUR LA SÛRETÉ QUE PAR DES PIÈCES RECOMMANDÉES PAR LE FABRICANT.

3) Operation P.C Board T2027C5030 (Model CS-F14)

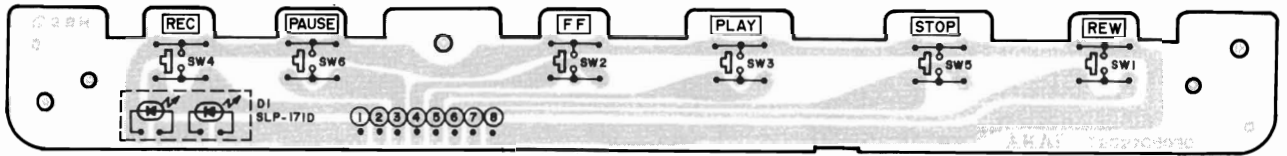

4) Operation P.C Board T2028C5010 (Model CS-F21)

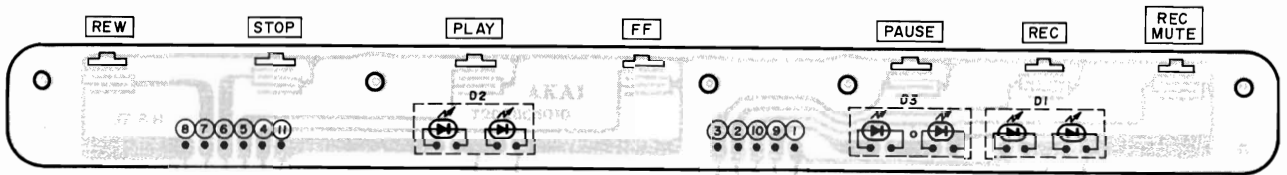

5) Meter P.C Board A2013C5030

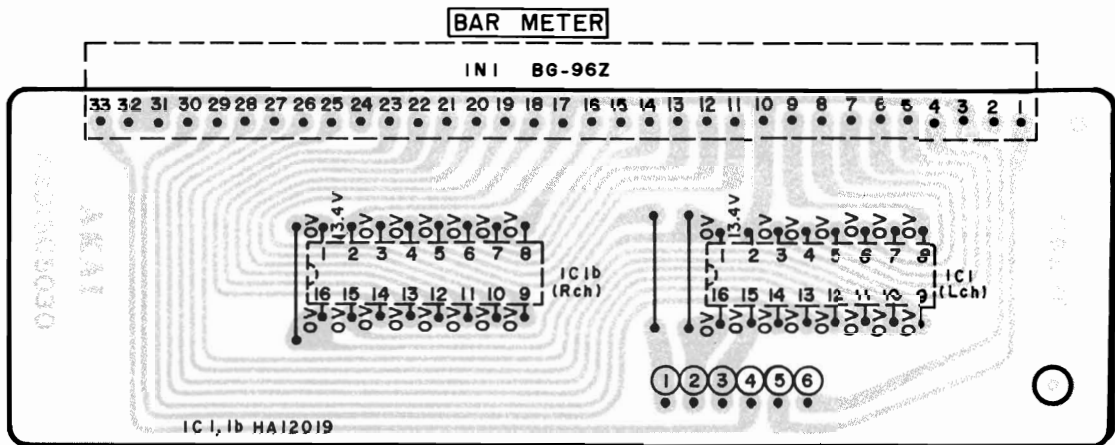

6) Power Supply P.C Board T2027B4020 (2ED) (U)

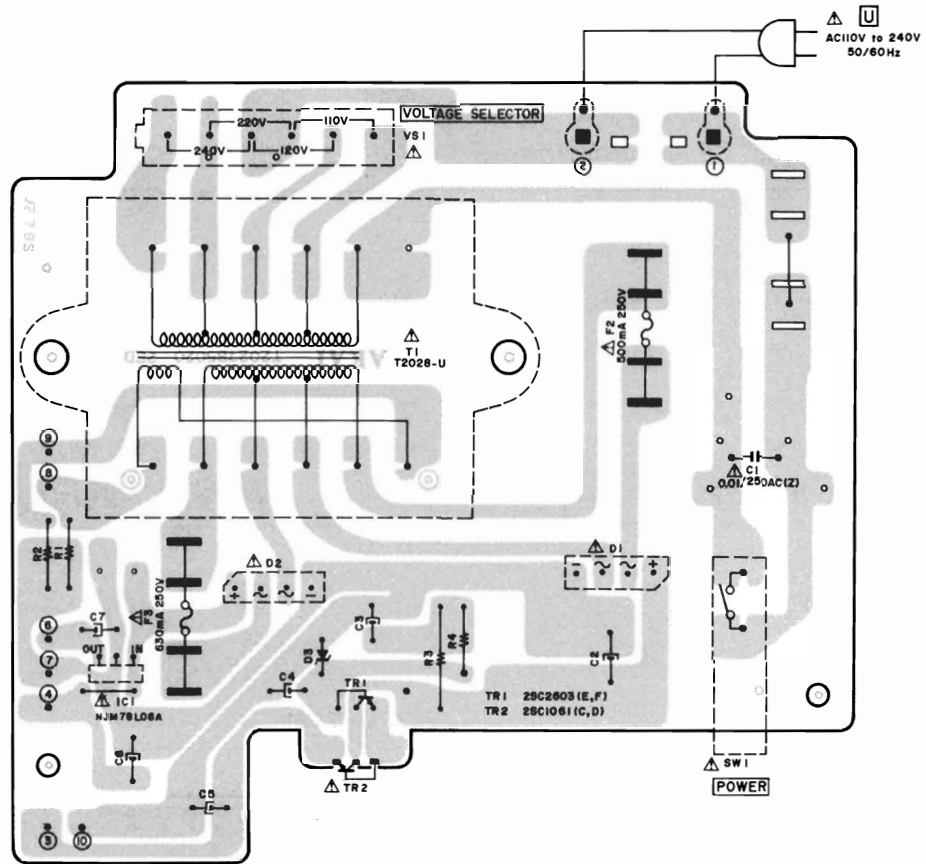
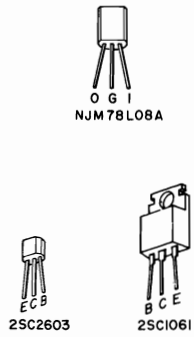

7) Power Supply P.C Board T2027B5020 (2ED) (C,A)

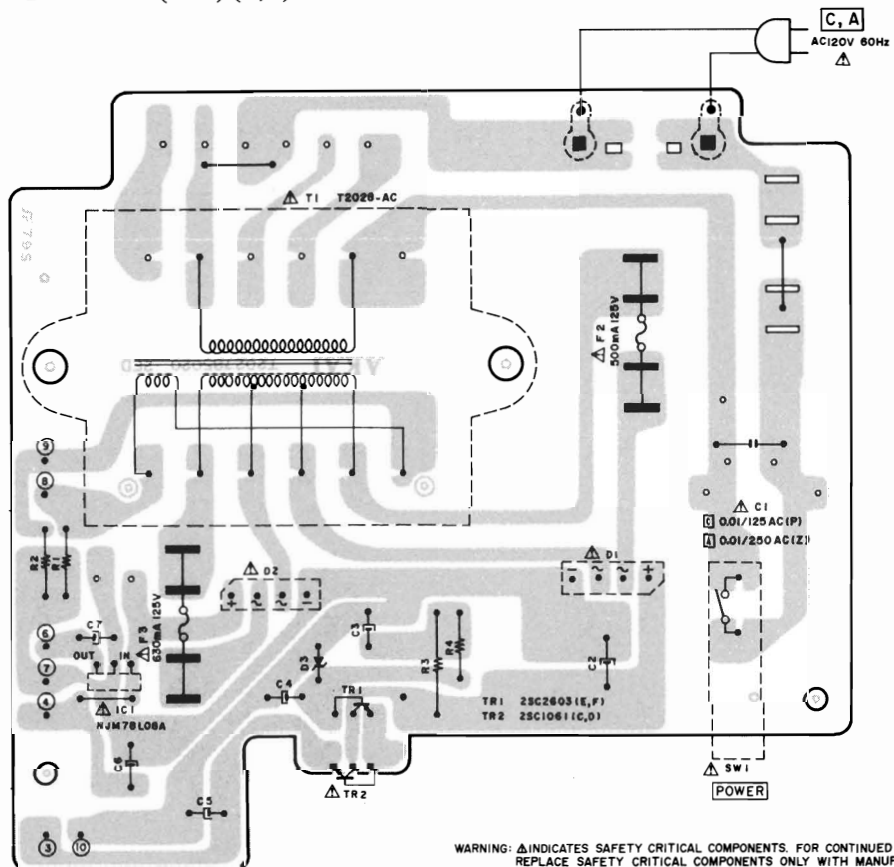
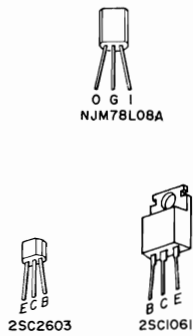

WARNING: Δ INDICATES SAFETY CRITICAL COMPONENTS. FOR CONTINUED SAFETY, REPLACE SAFETY CRITICAL COMPONENTS ONLY WITH MANUFACTURER'S RECOMMENDED PARTS.
 AVERTISSEMENT: Δ IL INDIQUE LES COMPOSANTS CRITIQUES DE SÛRETÉ. POUR MAINTENIR LE DEGRÉ DE SÛRETÉ DE L'APPAREIL NE REMPLACEZ LES COMPOSANTS DONT LE FONCTIONNEMENT EST CRITIQUE POUR LA SÛRETÉ QUE PAR DES PIÈCES RECOMMANDÉES PAR LE FABRICANT.

8) Power Supply P.C Board T2027B5020 (2ED) (E, V, B, S)

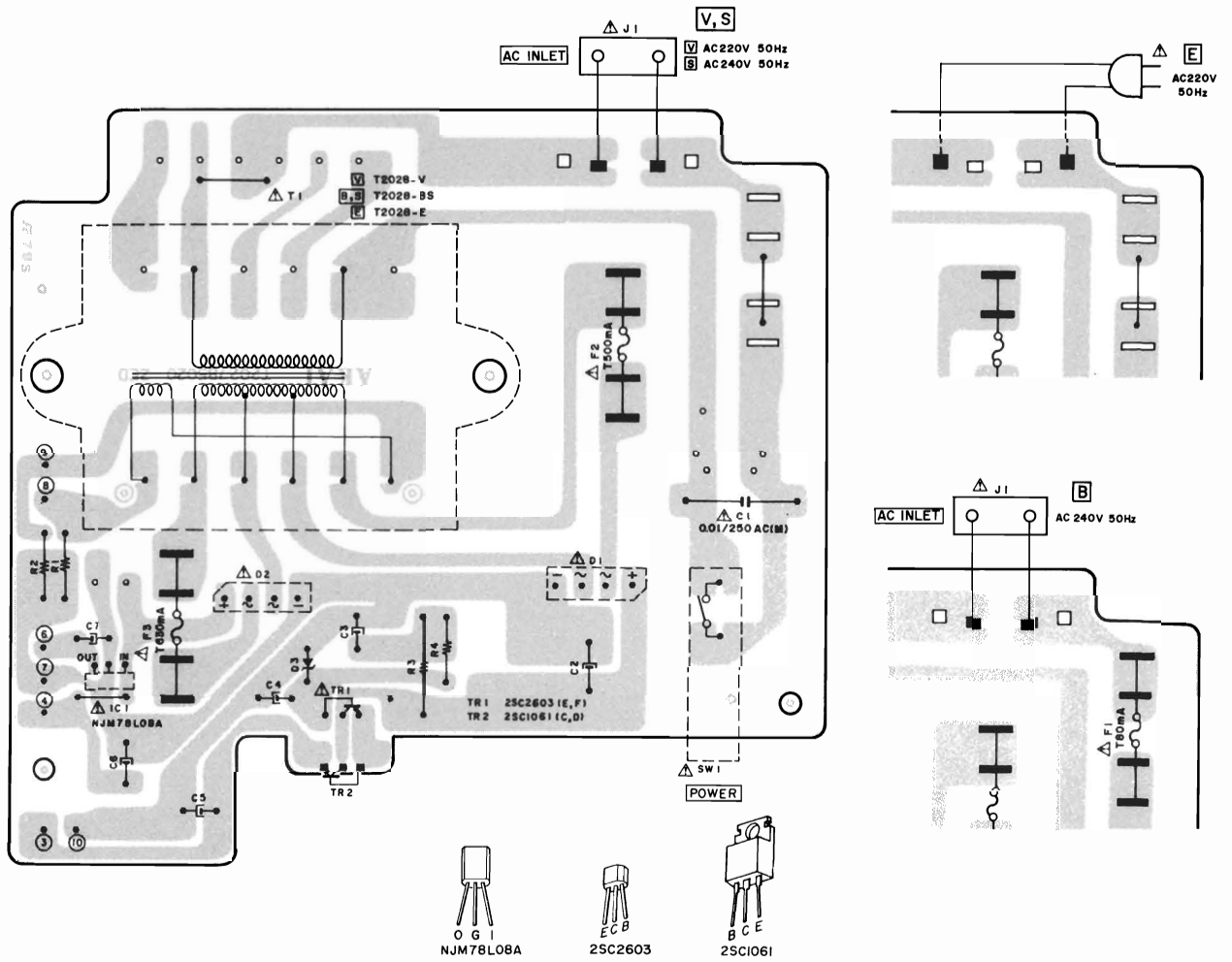

WARNING: Δ INDICATES SAFETY CRITICAL COMPONENTS. FOR CONTINUED SAFETY, REPLACE SAFETY CRITICAL COMPONENTS ONLY WITH MANUFACTURER'S RECOMMENDED PARTS
 AVERTISSEMENT: Δ IL INDIQUE LES COMPOSANTS CRITIQUES DE SÛRETÉ. POUR MAINTENIR LE DEGRÉ DE SÛRETÉ DE L'APPAREIL, NE REMPLACER LES COMPOSANTS DONT LE FONCTIONNEMENT EST CRITIQUE POUR LA SÛRETÉ QUE PAR DES PIÈCES RECOMMANDÉES PAR LE FABRICANT

SECTION 2

PARTS LIST

TABLE OF CONTENTS

I. MODEL CS-F14	27
RECOMMENDED SPARE PARTS	27
1. MECHA BLOCK	28
2. PRE AMP P.C BOARD BLOCK	30
3. POWER P.C BOARD BLOCK	30
4. OPERATION P.C BOARD BLOCK	30
5. METER P.C BOARD BLOCK	30
6. ASSEMBLY BLOCK	31
7. FINAL ASSEMBLY BLOCK	32
II. MODEL CS-F21	33
RECOMMENDED SPARE PARTS	33
1. MECHA BLOCK	34
2. PRE AMP P.C BOARD BLOCK	36
3. POWER P.C BOARD BLOCK	36
4. OPERATION P.C BOARD BLOCK	36
5. METER P.C BOARD BLOCK	36
6. ASSEMBLY BLOCK	37
7. FINAL ASSEMBLY BLOCK	38
INDEX	39

Resistor and Capacitor which is not listed in this parts list, please refer to
COMMON LIST FOR SERVICE PARTS.

ATTENTION

1. When placing an order for parts, be sure to list the parts no., model no., and description. There are instances in which if any of this information is omitted, parts cannot be shipped or the wrong parts will be delivered.
2. Please be careful not to make a mistake in the parts no. If the parts no. is in error, a part different from the one ordered may be delivered.
3. Because parts number and parts unit supply in the Preliminary Parts List may be partially changed, please use this parts list for all future reference.

HOW TO USE THIS PARTS LIST

1. This Parts List shows the parts that are considered necessary for repairs. Other parts, such as resistors and capacitors, are shown in the "Common List for Service Parts". Select and order such parts from the "Common List for Service Parts".
2. The Recommended Spare Parts shows those parts in the Parts List which are considered particularly important for service.
3. Parts not shown in the Parts List and "Common List for Service Parts" will not be supplied in principle.
4. How to read list

a) Mechanism Block

b) P.C Board Block

2. HEAD BASE BLOCK

REF. NO.	PARTS NO.	DESCRIPTION
2-1x	BH-T2023A320A	HEAD BASE BLOCK GX-F66R
2-2	HP-H2206A010A	HEAD R/P PR4-8FU C
2-3	ZS-477876	PAN20x03STL CMT
2-4	ZS-536488	BID20x08STL CMT
2-5	ZG-402895	CS ANGLE ADJUST SPRING

SP (Service Parts) Classification

A small "x" indicates the inability to show that particular part in the Photo or Illustration.

This number corresponds with the individual parts index number in that figure

This number corresponds with the Figure Number

6. SYS. CON. P.C BOARD BLOCK

REF. NO.	PARTS NO.	DESCRIPTION
6-1	BA-T2034A070A	PC SYS CON BLK GX-F44R
6-IC1	EI-324536	IC HD14049BP
6-IC2	EI-336801	IC MB8841-564M
6-IC3	EI-331661	IC SN7405N
6-IC4	EI-336725	IC M54527P
6-TR1to4	ET-200985	TR 2SC2603 F,G
6-TR5to28	ET-554657	TR 2SA733A P,Q
6-D1	ED-318292	D SILICON H 1S2473T-77T2 6
6-D2to4	ED-308952	D GERMA V 1K34A-LR F07
6-D5to10	ED-318292	D SILICON H 1S2473T-77T2 6
6-X1	EI-318384	OSC X'TAL NC-18C 3.579545MHZ

SP (Service Parts) Classification

This reference numbers corresponds with symbol numbers of Schematic Diagrams.

5. Both the kind of part and installation position can be determined by the Parts Number. To determine where a parts number is listed, utilize Parts Index at end of Parts List. It is necessary first of all to find the Parts Number. This can be accomplished by using the Reference Number listed at right of parts number in the Parts Index.

WARNING

△ INDICATES SAFETY CRITICAL COMPONENTS. FOR CONTINUED SAFETY, REPLACE SAFETY CRITICAL COMPONENTS ONLY WITH MANUFACTURER'S RECOMMENDED PARTS.

AVERTISSEMENT

△ IL INDIQUE LES COMPOSANTS CRITIQUES DE SURETE. POUR MAINTENIR LE DEGRE DE SECURITE DE L'APPAREIL NE REMPLACER LES COMPOSANTS DONT LE FONCTIONNEMENT EST CRITIQUE POUR LA SECURITE QUE PAR DES PIECES RECOMMANDEES PAR LE FABRICANT.

MECHA BLOCK

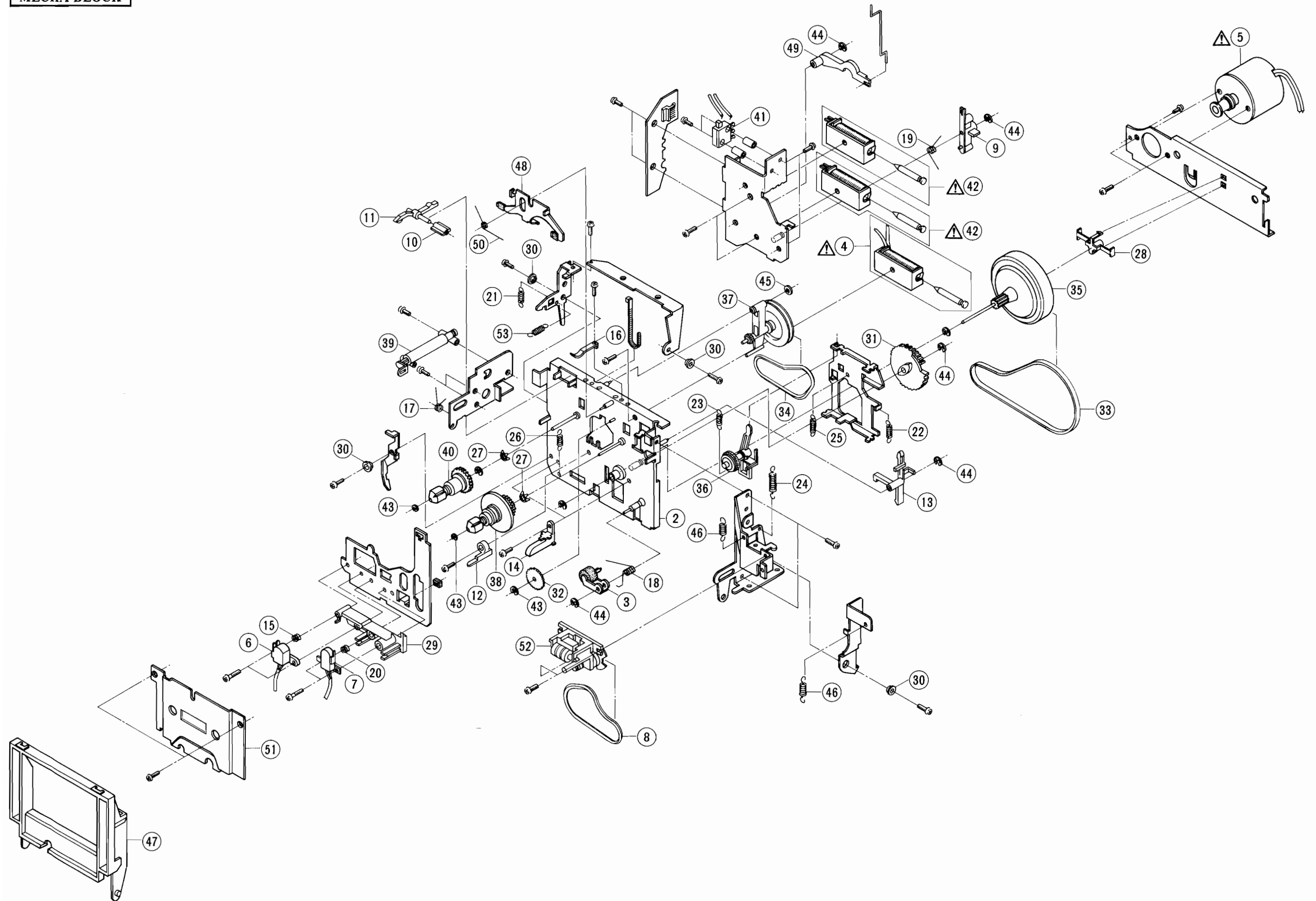

I . MODEL CS-F14

RECOMMENDED SPARE PARTS

Because, if the parts listed below are on hand, almost any repair can be accomplished, we suggest that you stock these Recommended Spare Parts Items.

PARTS NO.	DESCRIPTION	PARTS NO.	DESCRIPTION
1	BF-706394 FLYWHEEL ASSY	65	ET-328437 TR 2SD1012-V F,G
2	BM-706361 Δ MOTOR	66	ET-332424 TR 2SD1111 AKAI
3	BR-706399 SUPPLY REEL ASSY	67	EV-315416 R S-FIX H D8 3P 103
4	BR-706397 TAKE-UP REEL ASSY	68	EV-315414 R S-FIX H D8 3P 203
5	BT-332227 Δ TRANS POWER T2028-AC (C,A)	69	EV-322413 R S-FIX H D8 3P 302
6	BT-332230 Δ TRANS POWER T2028-BS (B,S)	70	EV-322416 R S-FIX H D8 3P 303
7	BT-332229 Δ TRANS POWER T2028-EV (E,V)	71	EV-315413 R S-FIX H D8 3P 503
8	BT-332231 Δ TRANS POWER T2028-J (J)	72	EV-336785 R S-FIX H TM8KV2-1S 3P 0.50W 104
9	BT-332228 Δ TRANS POWER T2028-U (U)	73	EV-337068 VR ROTARY 16P10x11 W204
10	ED-328605 D GERMA H 1S188FM-1-LH SNP	74	EV-337193 VR ROTARY 16P20x2T A104
11	ED-308952 D GERMA V 1K34A-LR F07	75	HE-706363 HEAD E HJ213270 C
12	ED-322982 D GERMA V 1S188FM-1-LR F07	76	HP-706362 HEAD REC/PB HN424977 C
13	ED-332243 D LED SLP-171D RED	77	MB-706392 BELT MAIN
14	ED-200469 D SILICON H DS448 FA5 F10	78	MB-706393 BELT SUB
15	ED-200468 D SILICON V DS448-VB6	79	MB-706365 COUNTER BELT
16	ED-323979 D SILICON W03B F12 100/1.0A	80	MC-706413 COUNTER ME390-117
17	ED-322238 D SILICON 1B4B41 100/1.0A	81	MI-706395 IDLER ASSY
18	ED-316540 D ZENER H HZ20 1	82	MP-706359 PINCH ROLLER ASSY
19	ED-337295 D ZENER H HZ3 C3	83	TC-706396 CLUTCH ASSY
20	ED-329058 D ZENER H HZ5 C1	84	TC-706398 DAMPER ASSY
21	EF-307178 Δ FUSE EAWK T 250V 0.08A (B)(F1)		
22	EF-593706 Δ FUSE SEMKO T 250V 0.50A (E,B,S,V) (F2)		
23	EF-601942 Δ FUSE SEMKO T 250V 0.63A (E,B,S,V) (F3)		
24	EF-327103 Δ FUSE TSC A 250V 0.50A (U,J)(F2)		
25	EF-306124 Δ FUSE TSC A 250V 0.63A (U,J)(F3)		
26	EF-309390 Δ FUSE TSC 125V 0.50A (C,A)(F2)		
27	EF-305703 Δ FUSE TSC 125V 0.63A (C,A)(F3)		
28	EI-315799 IC HA12019		
29	EI-336983 IC HA12038		
30	EI-338353 IC NJM78L08A		
31	EI-304657 IC TC4011BP		
32	EI-330965 IC TC4049BP		
33	EI-332425 IC TK11002		
34	EJ-310567 Δ SOCKET INLET 0378PC-GS E 2P (B,S,V)		
35	EJ-283140 Δ SOCKET SELECTER X-I7238 6P (U)		
36	EM-332427 IND FL BG-96Z GRAPH		
37	EO-337044 COIL FIX 2 102AK-005 36MH		
38	EO-332420 COIL OSC 1 0365-047 100KHz		
39	EO-315758 COIL TUN 1 100S-431 100KHz		
40	EO-321336 COIL VARI 1 FE002 10MH		
41	EP-706360 Δ SOLENOID		
42	EP-706401 Δ SOLENOID		
43	EP-337067 RELAY LEAD LAB2NS 2NO 18V		
44	ER-307565 Δ R FUSE ERD2FC 1/4W 6R8J		
45	ER-336775 FILTER DB D07001K 19KHz		
46	ER-336776 FILTER DB D07003K 100KHz		
47	ES-312234 Δ SW PUSH SDL-1P 01-1 E (U,E,B,S,V)		
48	ES-312235 Δ SW PUSH SDL-1P 01-1 J (J)		
49	ES-312238 Δ SW PUSH SDL-1P 01-1 UC (C,A)		
50	ES-332413 SW LEVER 00220670 2-02-02N		
51	ES-332412 SW LEVER 00230651 2-02-03N		
52	ES-336781 SW LEVER 00430540 2-04-03S		
53	ES-321274 SW LEVER 63349 2-06-03S		
54	ES-706400 SW SLIDE		
55	ES-336780 SW TACT KHH10902		
56	ET-311977 PHOTO SENSOR SPI-201		
57	ET-200558 TR 2SA1115 E,F		
58	ET-332422 TR 2SB774 Q,R,S		
59	ET-317919 TR 2SC1061 C,D		
60	ET-603257 TR 2SC1312S G,H		
61	ET-308937 TR 2SC2130 G,H		
62	ET-309353 TR 2SC2274 E,F		
63	ET-200505 TR 2SC2603 E,F		
64	ET-332421 TR 2SD1010 R,S		

1. MECHA BLOCK

REF. NO.	PARTS NO.	DESCRIPTION
1-1x	BZ-336355	MECHA ASSEMBLY FHE-7
1-2	BZ-706358	CHASSIS ASSY
1-3	MP-706359	PINCH ROLLER ASSY
1-4	EP-706360	△ SOLENOID
1-5	BM-706361	△ MOTOR
1-6	HP-706362	HEAD REC/PB HN424977 C
1-7	HE-706363	HEAD E HJ213270 C
1-8	MB-706365	COUNTER BELT
1-9	TC-706366	FF SOLENOID ARM
1-10	TC-706367	REC STOPPER
1-11	TC-706368	RECORD ARM
1-12	TC-706369	REFERENCE GUIDE
1-13	TC-706370	PLAY SOLENOID ARM
1-14	TC-706371	CASSETTE GUIDE
1-15	ZG-706372	SP AZIMUTH
1-16	ZG-706373	SP CASSETTE
1-17	ZG-706374	SP DOOR
1-18	ZG-706376	SP PINCH ROLLER
1-19	ZG-706377	SP SOLENOID BKT
1-20	ZG-706378	SP AZIMUTH
1-21	ZG-706379	SP LOCK ARM
1-22	ZG-706380	SP ASSIST BASE
1-23	ZG-706381	SP PLAY IDLER
1-24	ZG-706382	SP PLAY SOL ARM
1-25	ZG-706383	SP HEAD BASE
1-26	ZG-706384	SP HEAD BASE HOLDER
1-27	ZG-706385	SP BACK TENSION
1-28	TC-706387	F/W SPACER
1-29	HZ-706388	HEAD SPACER
1-30	TC-706389	SPACER
1-31	TC-706390	PLAY GEAR
1-32	TC-706391	IDLER GEAR
1-33	MB-706392	BELT MAIN
1-34	MB-706393	BELT SUB
1-35	BF-706394	FLYWHEEL ASSY
1-36	MI-706395	IDLER ASSY
1-37	TC-706396	CLUTCH ASSY
1-38	BR-706397	TAKE-UP REEL ASSY
1-39	TC-706398	DAMPER ASSY
1-40	BR-706399	SUPPLY REEL ASSY
1-41	ES-706400	SW SLIDE
1-42	EP-706401	△ SOLENOID
1-43	ZW-706402	LOCK WASHER
1-44	ZW-706403	LOCK WASHER
1-45	ZW-706404	LOCK WASHER
1-46	ZG-706405	SP EJECT RETURN LEVER
1-47	TC-706406	SUPPORT CASSETTE ASSY
1-48	TC-706407	BRAKE ASSY
1-49	TC-706409	BRAKE ARM
1-50	ZG-706411	SP BRAKE
1-51	TC-706412	DECORATION PLATE
1-52	MC-706413	COUNTER ME390-117
1-53	ZG-706414	SP BRAKE ARM

2. PRE AMP P.C BOARD BLOCK

REF. NO.	PARTS NO.	DESCRIPTION
2-1	BA-T2039A030A	PC PRE AMP BLK CS-F14 (U) (U,J,C,A)
2-2	BA-T2039A030B	PC PRE AMP BLK CS-F14 (E) (E,V,B,S)
2-3	BA-T2039A030C	PC PRE AMP BLK CS-F14-P (U) (U,J,C,A)
2-4	BA-T2039A030D	PC PRE AMP BLK CS-F14-P (E) (E,V,B,S)
PRE AMP P.C BOARD BLOCK		
2-IC1	EI-332425	IC TK11002
2-IC2	EI-305456	IC TC4049BP
2-IC3	EI-304657	IC TC4011BP
2-IC4	EI-336983	IC HA12038
2-TR1,2	ET-332422	TR 2SB774 Q,R,S
2-TR3	ET-200505	TR 2SC2603 E,F
2-TR4to6	ET-332424	△ TR 2SD1111 AKAI
2-TR8	ET-200505	TR 2SC2603 E,F
2-TR10,11	ET-603257	TR 2SC1312S G,H
2-TR12	ET-200505	TR 2SC2603 E,F
2-TR13	ET-309353	△ TR 2SC2274 E,F
2-TR14to16	ET-603257	TR 2SC1312S G,H
2-TR17	ET-200558	TR 2SA1115 E,F
2-TR19,20	ET-200505	TR 2SC2603 E,F
2-TR21	ET-328437	TR 2SD1012-V F,G
2-TR22	ET-200505	TR 2SC2603 E,F
2-TR23,24	ET-309353	TR 2SC2274 E,F
2-TR25	ET-200505	TR 2SC2603 E,F
2-TR26	ET-317919	TR 2SC1061 C,D
2-TR27,28	ET-200505	TR 2SC2603 E,F
2-TR29	ET-200558	TR 2SA1115 E,F
2-TR30	ET-308937	TR 2SC2130 G,H
2-TR31	ET-603257	TR 2SC1312S G,H
2-TR33	ET-200505	TR 2SC2603 E,F
2-TR35	ET-332421	TR 2SD1010 R,S
2-TR36	ET-200505	TR 2SC2603 E,F
2-D1	ED-200469	D SILICON H DS448 FA5 F10
2-D2,3	ED-200468	D SILICON V DS448-VB6
2-D4to8	ED-200469	D SILICON H DS448 FA5 F10
2-D9,10	ED-200468	D SILICON V DS448-VB6
2-D11	ED-323979	D SILICON W03B F12 100/1.0A
2-D12	ED-200468	D SILICON V DS448-VB6
2-D13,14	ED-323979	D SILICON W03B F12 100/1.0A
2-D16	ED-200468	D SILICON V DS448-VB6
2-D17,18	ED-328605	D GERMA H 1S188FM-1-LH SNP
2-D19	ED-322982	D GERMA V 1S188FM-1-LR F07
2-D20to22	ED-200468	D SILICON V DS448-VB6
2-D23	ED-322982	D GERMA V 1S188FM-1-LR F07
2-D33,34	ED-200468	D SILICON V DS448-VB6
2-D35,36	ED-322982	D GERMA V 1S188FM-1-LR F07
2-D37	ED-308952	D GERMA V 1K34A-LR F07
2-D38	ED-323979	D SILICON W03B F12 100/1.0A
2-D39	ED-200468	D SILICON V DS448-VB6
2-D40	ED-329058	D ZENER H HZ5 C1
2-D41	ED-337295	D ZENER H HZ3 C3
2-D42,43	ED-200468	D SILICON V DS448-VB6
2-J4	EJ-332435	PIN J P 4P (U,J,C,A)
2-J4	EJ-332437	JACK PLATE (E,V,B,S)
2-J5	EJ-336783	PHONE J THROW HLJ0523-220 2x3P
2-J5	EJ-332415	PHONE J THROW HLJ0523-020 2x3P (P)
2-J6	EJ-336782	PHONE J 3P HLJ0328-023 6.3
2-J6	EJ-332416	PHONE J 3P HLJ0328-020 6.3 (P)
2-SW1	ES-321274	SW LEVER 63349 2-06-03S
2-SW2	ES-336781	SW LEVER 00430540 2-04-03S
2-SW3	ES-332412	SW LEVER 00230651 2-02-03N
2-SW4	ES-332413	SW LEVER 00220670 2-02-02N
2-VR1	EV-315413	R S-FIX H D8 3P 503
2-VR2	EV-322416	R S-FIX H D8 3P 303
2-VR3	EV-315414	R S-FIX H D8 3P 203
2-VR4	EV-315416	R S-FIX H D8 3P 103
2-VR5	EV-322413	R S-FIX H D8 3P 302
2-VR6	EV-336785	R S-FIX H TM8KV2-1S 3P 0.50W 104
2-VR8	EV-337068	VR ROTARY 16P10x11 W204
2-RL1	EP-337067	RELAY LEAD LAB2NS 2NO 18V

REF. NO.	PARTS NO.	DESCRIPTION
2-VL1	EO-321336	COIL VARI 1 FE002 10MH
2-T1	EO-332420	COIL OSC 1 0365-047 100KHz
2-FL1	EO-315758	COIL TUN 1 100S-431 100KHz
2-FL2	ER-336775	FILTER DB D07001K 19KHz
2-FL3	ER-336776	FILTER DB D07003K 100KHz
2-FL4	EO-337044	COIL FIX 2 102AK-005 36MH
2-FR1,2	ER-307565	△ R FUSE ERD2FC 1/4W 6R8J
2-C21	EC-307494	C STY V F05 CQ09S 331J 50DC
2-C23	EC-306017	C STY V F05 CQ09S 221J 50DC
2-C24	EC-201319	C MC V FM 270J 500DC
2-C63	EC-306018	C STY V F05 CQ09S 681J 50DC
2-C84	EC-325352	C MC V FM 151J 500DC
2-C85	EC-326138	C PP V F10 PFH 182J 630DC
2-C87	EC-341675	C PP V APS 223K 100DC
2-C93	EC-427948	C MC V FM 100J 500DC
2-C97	EC-427948	C MC V FM 100J 500DC
2-C98	EC-331631	C STY V SNP CQFS 821J 50DC
2-C101	EC-306017	C STY V F05 CQ09S 221J 50DC

DETECTOR P.C BOARD BLOCK

2-PH1	ET-311977	PHOTO SENSOR SPI-201
-------	-----------	----------------------

VOLUME P.C BOARD BLOCK

2-VR1	EV-337193	VR ROTARY 16P20x2T A104
-------	-----------	-------------------------

3. POWER P.C BOARD BLOCK

REF. NO.	PARTS NO.	DESCRIPTION
3-IC1	EI-338353	△ IC NJM78L08A
3-TR1	ET-200505	TR 2SC2603 E,F
3-TR2	ET-317919	△ TR 2SC1061 C,D
3-D1,2	ED-322238	△ D SILICON 1B4B41 100/1.0A
3-D3	ED-316540	△ D ZENER H HZ20 1
3-VS1	EJ-283140	△ SOCKET SELECTER X-17238 6P (U)
3-R3	ER-318430	△ R OMF H SNP FS 1W 102J
3-C1	EC-320548	△ C CE V F 103Z 250AC (U,J,A)
3-C1	EC-314688	△ C CE V FZ 103P 125AC (C)
3-C1	EC-330308	△ C MMY V ECQUF 103M 250AC (E,B,S,V)

4. OPERATION P.C BOARD BLOCK

REF. NO.	PARTS NO.	DESCRIPTION
4-D1	ED-332243	D LED SLP-171D RED
4-SW1to6	ES-336780	SW TACT KHH10902

5. METER P.C BOARD BLOCK

REF. NO.	PARTS NO.	DESCRIPTION
5-IC1	EI-315799	IC HA12019
5-IN1	EM-332427	IND FL BG-96Z GRAPH

ASSEMBLY BLOCK

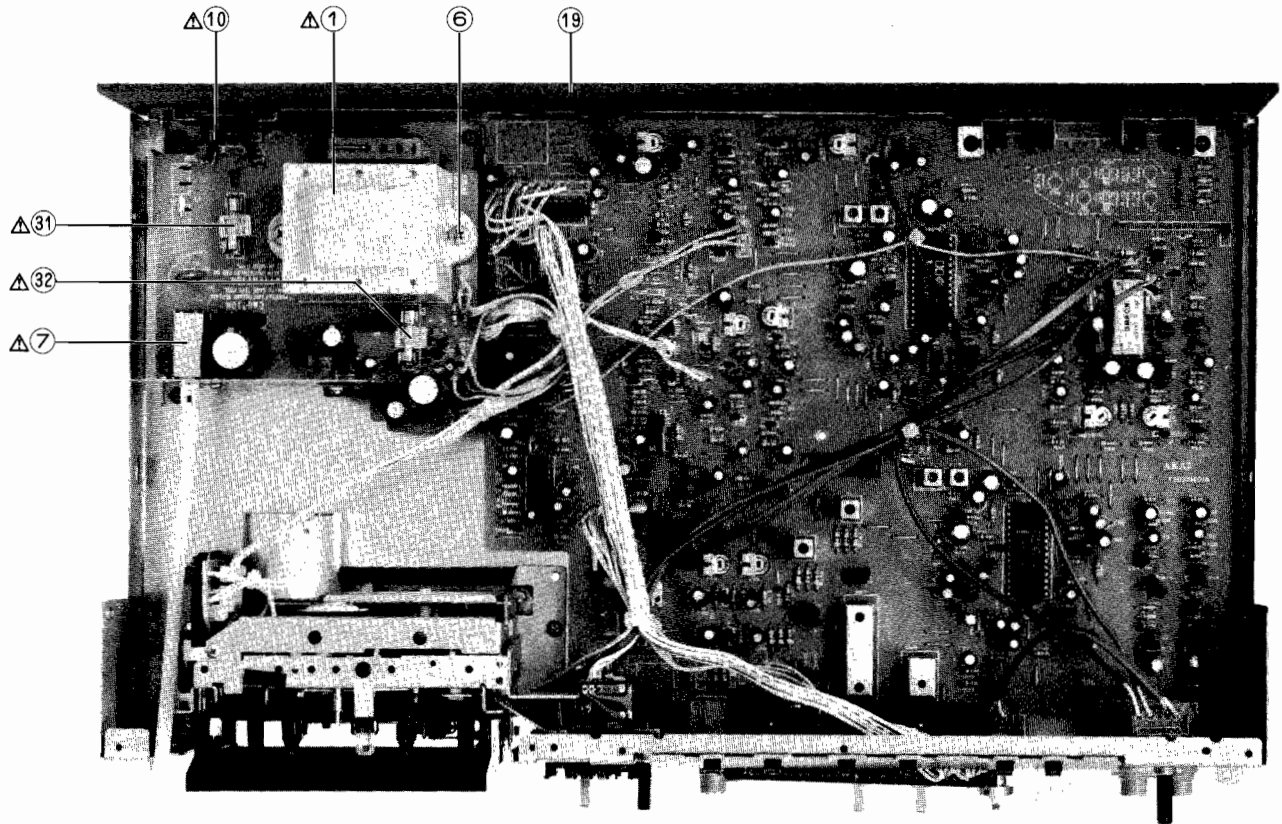

6. ASSEMBLY BLOCK

REF. NO.	PARTS NO.	DESCRIPTION	REF. NO.	PARTS NO.	DESCRIPTION
POWER SUPPLY BLOCK			ASSEMBLY BLOCK		
6-1	BT-332228	△ TRANS POWER T2028-U (U)	6-19	SP-336670H	PANEL REAR CS-F14 (U) AS
6-2x	BT-332227	△ TRANS POWER T2028-AC (C,A)	6-20x	SP-336670J	PANEL REAR CS-F14 (J) AS
6-3x	BT-332229	△ TRANS POWER T2028-EV (E,V)	6-21x	SP-336670K	PANEL REAR CS-F14 (C) AS
6-4x	BT-332230	△ TRANS POWER T2028-BS (B,S)	6-22x	SP-336670L	PANEL REAR CS-F14 (A) AS
6-5x	BT-332231	△ TRANS POWER T2028-J (J)	6-23x	SP-336670M	PANEL REAR CS-F14 (E) AS
6-6	ZS-312116	ST BID40x20STL CMT	6-24x	SP-336670P	PANEL REAR CS-F14 (B,S) AS
6-7	ES-312234	△ SW PUSH SDL-1P 01-1 E (U,E,B,S,V)	6-25x	SP-336670N	PANEL REAR CS-F14 (V) AS
6-8x	ES-312238	△ SW PUSH SDL-1P 01-1 UC (C,A)	6-26x	ZS-331567	T2BR30x08STL CMT C080
6-9x	ES-312235	△ SW PUSH SDL-1P 01-1 J (J)	6-27x	SA-202118	FOOT
6-10	EW-306428	△ AC CORD 2 CORES KP-205A, VFF J (U)	6-28x	ZS-331567	T2BR30x08STL CMT C080
6-11x	EW-306427	△ AC CORD 2 CORES KP-211, VFF J (J)	6-29x	SA-336217	FOOT
6-12x	EW-305691	△ AC CORD 2 CORES KP-8, SPT-1 UC (C,A)	6-30x	ZW-305013	RV POP32
6-13x	EW-313882	△ AC CORD 2 CORES KP-419C, LTCE-2F E (E)	6-31	EF-327103	△ FUSE TSC A 250V 0.50A (F2)(U,J)
6-14x	EW-322400	△ AC CORD 2 CORES GTBS-2F/ KS-15 B (B)	6-32	EF-306124	△ FUSE TSC A 250V 0.63A (F3)(U,J)
6-15x	EW-322401	△ AC CORD 2 CORES KP-560/S-15 S	6-33x	EF-309390	△ FUSE TSC 125V 0.50A (F2)(C,A)
6-16x	EW-315767	△ AC CORD 2 CORES KP-419C/ KS-15 E (V)	6-34x	EF-305703	△ FUSE TSC 125V 0.63A (F3)(C,A)
6-17x	SZ-631945	STRAIN RELIEF SR-4N-4 (U,J,C,A,E)	6-35x	EF-307178	△ FUSE EAWK T 250V 0.08A (F1)(B)
6-18x	EJ-310567	△ SOCKET INLET 0378PC-GS E 2P (B,S,V)	6-36x	EF-593706	△ FUSE SEMKO T 250V 0.50A (F2) (E,B,S,V)
			6-37x	EF-601942	△ FUSE SEMKO T 250V 0.63A (F3) (E,B,S,V)
			6-38x	EW-318452	CORD RR-163 PIN-PIN/2P

FINAL ASSEMBLY BLOCK

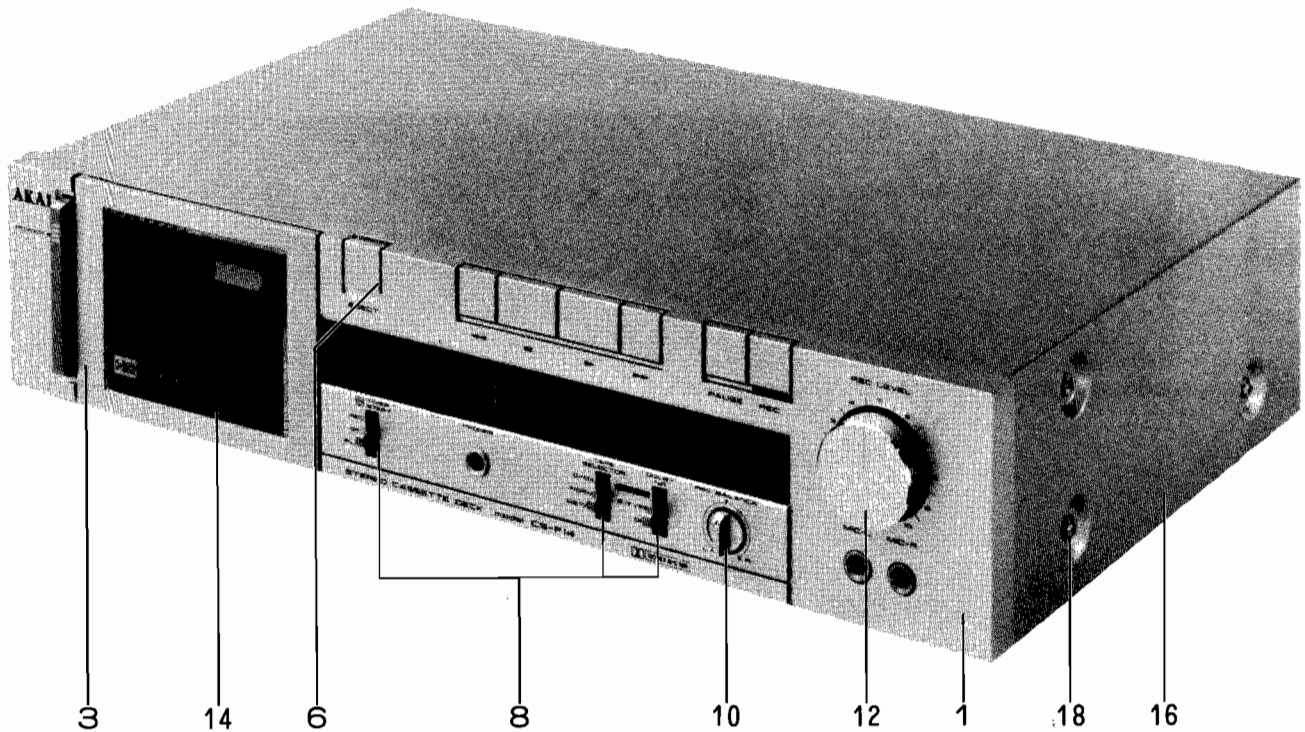

7. FINAL ASSEMBLY BLOCK

REF. NO.	PARTS NO.	DESCRIPTION
FRONT PANEL BLOCK		
7-1	BD-B332598A4	PANEL FRONT PART
7-2x	BD-B332598B4	PANEL FRONT-P PART
7-3	SK-332589A	KNOB POWER
7-4x	SK-332589B	KNOB POWER-P
7-5x	ZG-332762	SP PUSH KNOB
7-6	SK-332601A	KNOB EJECT
7-7x	SK-332601B	KNOB EJECT-P
FINAL ASSEMBLY BLOCK		
7-8	SK-332590B	KNOB SW (A-2)
7-9x	SK-332590C	KNOB SW (A-3)
7-10	SK-332591B	KNOB VR (A-2)
7-11x	SK-332591C	KNOB VR (A-3)
7-12	SK-332592A	KNOB VR (B)
7-13x	SK-332592C	KNOB VR (B-2)-P
7-14	BD-B332596A3	LID PANEL PART
7-15x	BD-B332596B3	LID PANEL-P PART
7-16	SP-336654A	COVER UPPER
7-17x	SP-336654B	COVER UPPER-P
7-18	ZS-341959	ST BID40x06STL NI3
7-19x	ZS-341960	ST BID40x06STL BNI

II. MODEL CS-F21

RECOMMENDED SPARE PARTS

Because, if the parts listed below are on hand, almost any repair can be accomplished, we suggest that you stock these Recommended Spare Parts Items.

PARTS NO.	DESCRIPTION	PARTS NO.	DESCRIPTION
1	BF-706394 FLYWHEEL ASSY	66	ET-309353 TR 2SC2274 E,F
2	BM-706361 ▲ MOTOR	67	ET-200505 TR 2SC2603 E,F
3	BR-706399 SUPPLY REEL ASSY	68	ET-332421 TR 2SD1010 R,S
4	BR-706397 TAKE-UP REEL ASSY	69	ET-328437 TR 2SD1012-V F,G
5	BT-332227 ▲ TRANS POWER T2028-AC (C,A)	70	ET-332424 TR 2SD1111 AKAI
6	BT-332230 ▲ TRANS POWER T2028-BS (B,S)	71	EV-315416 R S-FIX H D8 3P 103
7	BT-332229 ▲ TRANS POWER T2028-EV (E,V)	72	EV-315414 R S-FIX H D8 3P 203
8	BT-332231 ▲ TRANS POWER T2028-J (J)	73	EV-322413 R S-FIX H D8 3P 302
9	BT-332228 ▲ TRANS POWER T2028-U (U)	74	EV-322416 R S-FIX H D8 3P 303
10	ED-328605 D GERMA H 1S188FM-1-LH SNP	75	EV-315413 R S-FIX H D8 3P 503
11	ED-308952 D GERMA V 1K34A-LR F07	76	EV-336785 R S-FIX H TM8KV2-1S 3P 0.50W 104
12	ED-322982 D GERMA V 1S188FM-1-LR F07	77	EV-337068 VR ROTARY 16P10x11 W204
13	ED-332243 D LED SLP-171D RED	78	EV-337192 VR ROTARY 16P20x2S B 103
14	ED-336786 D LED SLP-271D GRN	79	EV-337193 VR ROTARY 16P20x2T A 104
15	ED-332244 D LED SLP-471D YLW	80	HE-706363 HEAD E HJ213270 C
16	ED-200469 D SILICON H DS448 FA5 F10	81	HP-706362 HEAD REC/PB HN424977 C
17	ED-200468 D SILICON V DS448-VB6	82	MB-706392 BELT MAIN
18	ED-323979 D SILICON W03B F12 100/1.0A	83	MB-706393 BELT SUB
19	ED-322238 D SILICON 1B4B41 100/1.0A	84	MB-706365 COUNTER BELT
20	ED-316540 D ZENER H HZ20 1	85	MC-706413 COUNTER ME390-117
21	ED-337295 D ZENER H HZ3 C3	86	MI-706395 IDLER ASSY
22	ED-329058 D ZENER H HZ5 C1	87	MP-706359 PINCH ROLLER ASSY
23	EF-307178 ▲ FUSE EAWK T 250V 0.08A (B)(F1)	88	TC-706396 CLUTCH ASSY
24	EF-593706 ▲ FUSE SEMKO T 250V 0.50A (E,B,S,V) (F2)	89	TC-706398 DAMPER ASSY
25	EF-601942 ▲ FUSE SEMKO T 250V 0.63A (E,B,S,V) (F3)		
26	EF-327103 ▲ FUSE TSC A 250V 0.50A (U,J)(F2)		
27	EF-306124 ▲ FUSE TSC A 250V 0.63A (U,J)(F3)		
28	EF-309390 ▲ FUSE TSC 125V 0.50A (C,A)(F2)		
29	EF-305703 ▲ FUSE TSC 125V 0.63A (C,A)(F3)		
30	EI-315799 IC HA12019		
31	EI-336983 IC HA12038		
32	EI-338353 IC NJM78L08A		
33	EI-304657 IC TC4011BP		
34	EI-330965 IC TC4049BP		
35	EI-332425 IC TK11002		
36	EJ-310567 ▲ SOCKET INLET 0378PC-GS E 2P (B,S,V)		
37	EJ-283140 ▲ SOCKET SELECTER X-17238 6P (U)		
38	EJ-337654 DIN J UC-0044 P 8P		
39	EJ-332437 JACK PLATE (E,B,S,V)		
40	EJ-332435 PIN J P 4P (U,J,C,A)		
41	EM-332427 IND FL BG-96Z GRAPH		
42	EO-337044 COIL FIX 2 102AK-005 36MH		
43	EO-332420 COIL OSC 1 0365-047 100KHz		
44	EO-315758 COIL TUN 1 100S-431 100KHz		
45	EO-321336 COIL VARI 1 FE002 10MH		
46	EP-706360 ▲ SOLENOID		
47	EP-706401 ▲ SOLENOID		
48	EP-337067 RELAY LEAD LAB2NS 2NO 18V		
49	ER-307565 ▲ R FUSE ERD2FC 1/4W 6R8J		
50	ER-336775 FILTER DB D07001K 19KHz		
51	ER-336776 FILTER DB D07003K 100KHz		
52	ES-312234 ▲ SW PUSH SDL-1P 01-1 E (U,E,B,S,V)		
53	ES-312235 ▲ SW PUSH SDL-1P 01-1 J (J)		
54	ES-312238 ▲ SW PUSH SDL-1P 01-1 UC (C,A)		
55	ES-332413 SW LEVER 00220670 2-02-02N		
56	ES-332412 SW LEVER 00230651 2-02-03N		
57	ES-336781 SW LEVER 00430540 2-04-03S		
58	ES-321274 SW LEVER 63349 2-06-03S		
59	ES-706400 SW SLIDE		
60	ET-311977 PHOTO SENSOR SPI-201		
61	ET-200558 TR 2SA1115 E,F		
62	ET-332422 TR 2SB774 Q,R,S		
63	ET-317919 TR 2SC1061 C,D		
64	ET-603257 TR 2SC1312S G,H		
65	ET-308937 TR 2SC2130 G,H		

When ordering parts, please quote Parts Number, Description and Model Number.

MECHA BLOCK

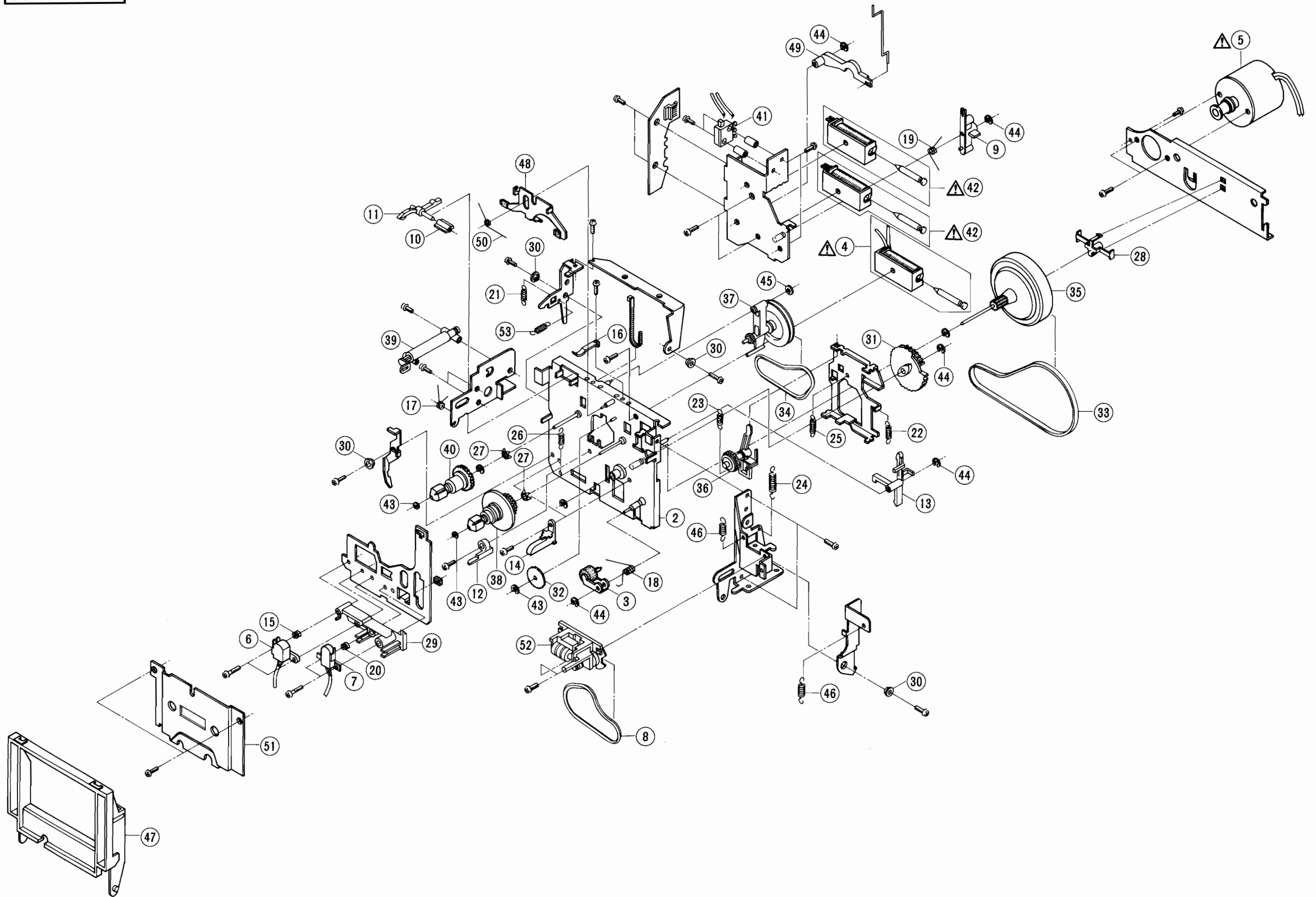

1. MECHA BLOCK

REF. NO.	PARTS NO.	DESCRIPTION
1-1x	BZ-336355	MECHA ASSEMBLY FHE-7
1-2	BZ-706358	CHASSIS ASSY
1-3	MP-706359	PINCH ROLLER ASSY
1-4	EP-706360	△ SOLENOID
1-5	BM-706361	△ MOTOR
1-6	HP-706362	HEAD REC/PB HN424977 C
1-7	HE-706363	HEAD E HJ213270 C
1-8	MB-706365	COUNTER BELT
1-9	TC-706366	FF SOLENOID ARM
1-10	TC-706367	REC STOPPER
1-11	TC-706368	RECORD ARM
1-12	TC-706369	REFERENCE GUIDE
1-13	TC-706370	PLAY SOLENOID ARM
1-14	TC-706371	CASSETTE GUIDE
1-15	ZG-706372	SP AZIMUTH
1-16	ZG-706373	SP CASSETTE
1-17	ZG-706374	SP DOOR
1-18	ZG-706376	SP PINCH ROLLER
1-19	ZG-706377	SP SOLENOID BKT
1-20	ZG-706378	SP AZIMUTH
1-21	ZG-706379	SP LOCK ARM
1-22	ZG-706380	SP ASSIST BASE
1-23	ZG-706381	SP PLAY IDLER
1-24	ZG-706382	SP PLAY SOL ARM
1-25	ZG-706383	SP HEAD BASE
1-26	ZG-706384	SP HEAD BASE HOLDER
1-27	ZG-706385	SP BACK TENSION
1-28	TC-706387	F/W SPACER
1-29	HZ-706388	HEAD SPACER
1-30	TC-706389	SPACER
1-31	TC-706390	PLAY GEAR
1-32	TC-706391	IDLER GEAR
1-33	MB-706392	BELT MAIN
1-34	MB-706393	BELT SUB
1-35	BF-706394	FLYWHEEL ASSY
1-36	MI-706395	IDLER ASSY
1-37	TC-706396	CLUTCH ASSY
1-38	BR-706397	TAKE-UP REEL ASSY
1-39	TC-706398	DAMPER ASSY
1-40	BR-706399	SUPPLY REEL ASSY
1-41	ES-706400	SW SLIDE
1-42	EP-706401	△ SOLENOID
1-43	ZW-706402	LOCK WASHER
1-44	ZW-706403	LOCK WASHER
1-45	ZW-706404	LOCK WASHER
1-46	ZG-706405	SP EJECT RETURN LEVER
1-47	TC-706406	SUPPORT CASSETTE ASSY
1-48	TC-706407	BRAKE ASSY
1-49	TC-706409	BRAKE ARM
1-50	ZG-706411	SP BRAKE
1-51	TC-706412	DECORATION PLATE
1-52	MC-706413	COUNTER ME390-117
1-53	ZG-706414	SP BRAKE ARM

2. PRE AMP P.C BOARD BLOCK

REF. NO.	PARTS NO.	DESCRIPTION
2-1	BA-T2037A030A	PC PRE AMP BLK CS-F21 (U) (U,J,C,A)
2-2	BA-T2037A030B	PC PRE AMP BLK CS-F21 (E) (E,V,B,S)
2-3	BA-T2037A030C	PC PRE AMP BLK CS-F21-P (U) (U,J,C,A)
2-4	BA-T2037A030D	PC PRE AMP BLK CS-F21-P (E) (E,V,B,S)
PRE AMP P.C BOARD BLOCK		
2-IC1	EI-332425	IC TK11002
2-IC2	EI-305456	IC TC4049BP
2-IC3	EI-304657	IC TC4011BP
2-IC4	EI-336983	IC HA12038
2-TR1,2	ET-332422	TR 2SB774 Q,R,S
2-TR3	ET-200505	TR 2SC2603 E,F
2-TR4 to 6	ET-332424	△ TR 2SD1111 AKAI
2-TR7	ET-308937	TR 2SC2130 G,H
2-TR8	ET-200505	TR 2SC2603 E,F
2-TR10,11	ET-603257	TR 2SC1312S G,H
2-TR12	ET-200505	TR 2SC2603 E,F
2-TR13	ET-309353	△ TR 2SC2274 E,F
2-TR14 to 16	ET-603257	TR 2SC1312S G,H
2-TR17	ET-200558	TR 2SA1115 E,F
2-TR19,20	ET-200505	TR 2SC2603 E,F
2-TR21	ET-328437	TR 2SD1012-V F,G
2-TR22	ET-200505	TR 2SC2603 E,F
2-TR23,24	ET-309353	TR 2SC2274 E,F
2-TR25	ET-200505	TR 2SC2603 E,F
2-TR26	ET-317919	TR 2SC1061 C,D
2-TR27,28	ET-200505	TR 2SC2603 E,F
2-TR29	ET-200558	TR 2SA1115 E,F
2-TR30	ET-308937	TR 2SC2130 G,H
2-TR31	ET-603257	TR 2SC1312S G,H
2-TR32 to 34	ET-200505	TR 2SC2603 E,F
2-TR35	ET-332421	TR 2SD1010 R,S
2-TR36	ET-200505	TR 2SC2603 E,F
2-D1	ED-200469	D SILICON H DS448 FA5 F10
2-D2,3	ED-200468	D SILICON V DS448-VB6
2-D4 to 8	ED-200469	D SILICON H DS448 FA5 F10
2-D9,10	ED-200468	D SILICON V DS448-VB6
2-D11	ED-323979	D SILICON W03B F12 100/1.0A
2-D12	ED-200468	D SILICON V DS448-VB6
2-D13,14	ED-323979	D SILICON W03B F12 100/1.0A
2-D15	ED-328605	D GERMA H 1S188FM-1-LH SNP
2-D16	ED-200468	D SILICON V DS448-VB6
2-D17,18	ED-328605	D GERMA H 1S188FM-1-LH SNP
2-D19	ED-322982	D GERMA V 1S188FM-1-LR F07
2-D20 to 22	ED-200468	D SILICON V DS448-VB6
2-D23	ED-322982	D GERMA V 1S188FM-1-LR F07
2-D31 to 34	ED-200468	D SILICON V DS448-VB6
2-D35,36	ED-322982	D GERMA V 1S188FM-1-LR F07
2-D37	ED-308952	D GERMA V 1K34A-LR F07
2-D38	ED-323979	D SILICON W03B F12 100/1.0A
2-D39	ED-200468	D SILICON V DS448-VB6
2-D40	ED-329058	D ZENER H HZ5 C1
2-D41	ED-337295	D ZENER H HZ3 C3
2-D42,43	ED-200468	D SILICON V DS448-VB6
2-J3	EJ-337654	DIN J UC-0044 P 8P
2-J4	EJ-332435	PIN J P 4P (U,J,C,A)
2-J4	EJ-332437	JACK PLATE (E,V,B,S)
2-J5	EJ-336783	PHONE J THROW HLJ0523-220 2x3P
2-J5	EJ-332415	PHONE J THROW HLJ0523-020 2x3P (P)
2-J6	EJ-336782	PHONE J 3P HLJ0328-023 6.3
2-J6	EJ-332416	PHONE J 3P HLJ0328-020 6.3 (P)
2-SW1	ES-321274	SW LEVER 63349 2-06-03S
2-SW2	ES-336781	SW LEVER 00430540 2-04-03S
2-SW3	ES-332412	SW LEVER 00230651 2-02-03N
2-SW4	ES-332413	SW LEVER 00220670 2-02-02N
2-VR1	EV-315413	R S-FIX H D8 3P 503
2-VR2	EV-322416	R S-FIX H D8 3P 303
2-VR3	EV-315414	R S-FIX H D8 3P 203
2-VR4	EV-315416	R S-FIX H D8 3P 103
2-VR5	EV-322413	R S-FIX H D8 3P 302

REF. NO.	PARTS NO.	DESCRIPTION
2-VR6	EV-336785	R S-FIX H TM8KV2-1S 3P 0.50W 104
2-VR7	EV-337192	VR ROTARY 16P20x2S B103
2-VR8	EV-337068	VR ROTARY 16P10x11 W204
2-RL1	EP-337067	RELAY LEAD LAB2NS 2NO 18V
2-VL1	EO-321336	COIL VARI 1 FE002 10MH
2-T1	EO-332420	COIL OSC 1 0365-047 100KHz
2-FL1	EO-315758	COIL TUN 1 100S-431 100KHz
2-FL2	ER-336775	FILTER DB D07001K 19KHz
2-FL3	ER-336776	FILTER DB D07003K 100KHz
2-FL4	EO-337044	COIL FIX 2 102AK-005 36MH
2-FR1,2	ER-307565	△ R FUSE ERD2FC 1/4W 6R8J
2-C21	EC-307494	C STY V F05 CQ09S 331J 50DC
2-C23	EC-306017	C STY V F05 CQ09S 221J 50DC
2-C24	EC-201319	C MC V FM 270J 500DC
2-C63	EC-306018	C STY V F05 CQ09S 681J 50DC
2-C84	EC-325352	C MC V FM 151J 500DC
2-C85	EC-326138	C PP V F10 PFH 182J 630DC
2-C87	EC-341675	C PP V APS 223K 100DC
2-C93	EC-427948	C MC V FM 100J 500DC
2-C97	EC-427948	C MC V FM 100J 500DC
2-C98	EC-331631	C STY V SNP CQFS 821J 50DC
2-C101	EC-306017	C STY V F05 CQ09S 221J 50DC

DETECTOR P.C BOARD BLOCK

2-PH1	ET-311977	PHOTO SENSOR SPI-201
-------	-----------	----------------------

VOLUME P.C BOARD BLOCK

2-VR1	EV-337193	VR ROTARY 16P20x2T A104
-------	-----------	-------------------------

3. POWER P.C BOARD BLOCK

REF. NO.	PARTS NO.	DESCRIPTION
3-IC1	EI-338353	△ IC NJM78L08A
3-TR1	ET-200505	TR 2SC2603 E,F
3-TR2	ET-317919	△ TR 2SC1061 C,D
3-D1,2	ED-322238	△ D SILICON 1B4B41 100/1.0A
3-D3	ED-316540	△ D ZENER H HZ20 1
3-VS1	EJ-283140	△ SOCKET SELECTOR X-17238 6P (U)
3-R3	ER-318430	△ R OMF H SNP FS 1W 102J
3-C1	EC-320548	△ C CE V F 103Z 250AC (U,J,A)
3-C1	EC-314688	△ C CE V FZ 103P 125AC (C)
3-C1	EC-330308	△ C MMY V ECQUF 103M 250AC (E,B,S,V)

4. OPERATION P.C BOARD BLOCK

REF. NO.	PARTS NO.	DESCRIPTION
4-D1	ED-332243	D LED SLP-171D RED
4-D2	ED-336786	D LED SLP-271D GRN
4-D3	ED-332244	D LED SLP-471D YLW

5. METER P.C BOARD BLOCK

REF. NO.	PARTS NO.	DESCRIPTION
5-IC1	EI-315799	IC HA12019
5-IN1	EM-332427	IND FL BG-96Z GRAPH

When ordering parts, please quote Parts Number, Description and Model Number.

ASSEMBLY BLOCK

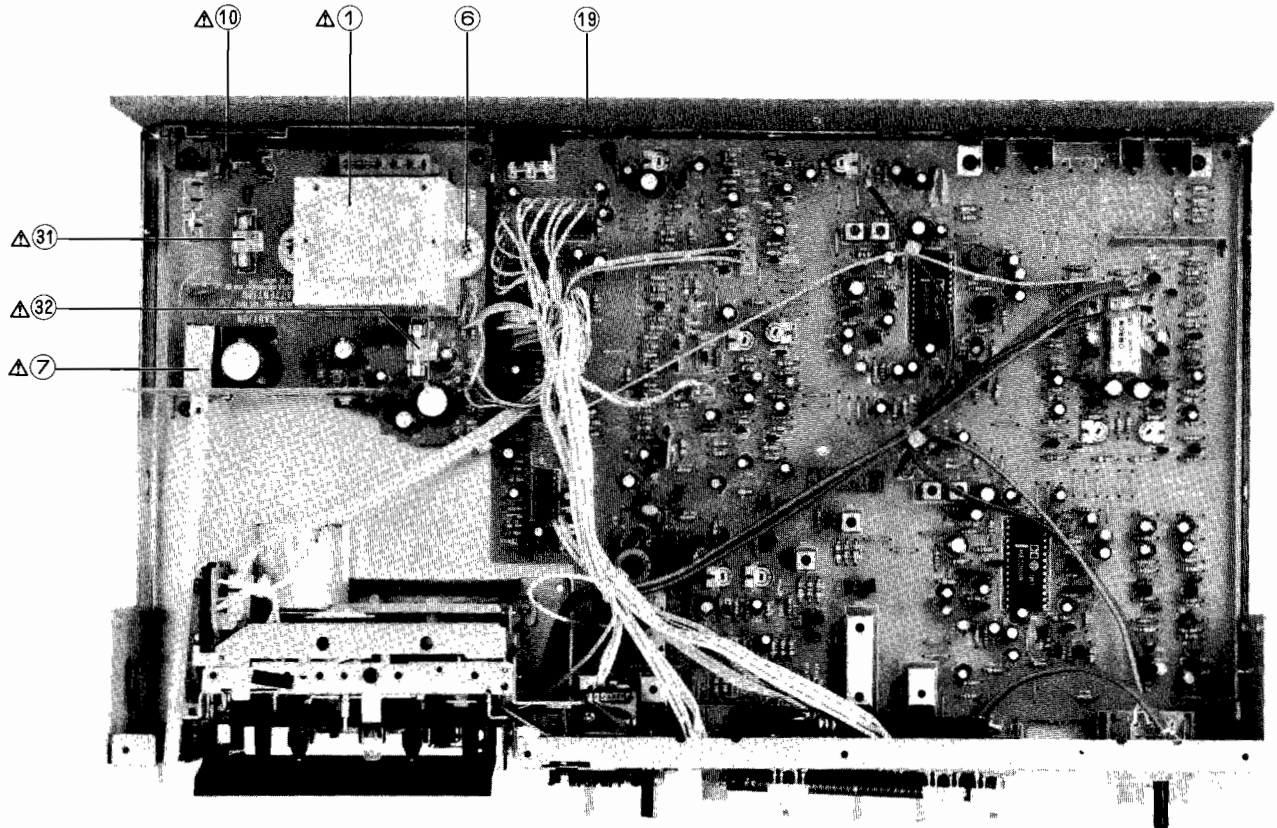

6. ASSEMBLY BLOCK

REF. NO.	PARTS NO.	DESCRIPTION	REF. NO.	PARTS NO.	DESCRIPTION
POWER SUPPLY BLOCK			ASSEMBLY BLOCK		
6-1	BT-332228	△ TRANS POWER T2028-U (U)	6-19	SP-336670Q	PANEL REAR CS-F21 (U) AS
6-2x	BT-332227	△ TRANS POWER T2028-AC (C,A)	6-20x	SP-336670R	PANEL REAR CS-F21 (J) AS
6-3x	BT-332229	△ TRANS POWER T2028-EV (E,V)	6-21x	SP-336670S	PANEL REAR CS-F21 (C) AS
6-4x	BT-332230	△ TRANS POWER T2028-BS (B,S)	6-22x	SP-336670T	PANEL REAR CS-F21 (A) AS
6-5x	BT-332231	△ TRANS POWER T2028-J (J)	6-23x	SP-336670U	PANEL REAR CS-F21 (E) AS
6-6	ZS-312116	ST BID40x20STL CMT	6-24x	SP-336670W	PANEL REAR CS-F21 (B,S) AS
6-7	ES-312234	△ SW PUSH SDL-1P 01-1 E (U,E,B,S,V)	6-25x	SP-336670V	PANEL REAR CS-F21 (V) AS
6-8x	ES-312238	△ SW PUSH SDL-1P 01-1 UC (C,A)	6-26x	ZS-331567	T2BR30x08STL CMT C080
6-9x	ES-312235	△ SW PUSH SDL-1P 01-1 J (J)	6-27x	SA-202118	FOOT
6-10	EW-306428	△ AC CORD 2 CORES KP-205A, VFF J (U)	6-28x	ZS-331567	T2BR30x08STL CMT C080
6-11x	EW-306427	△ AC CORD 2 CORES KP-211, VFF J (J)	6-29x	SA-336217	FOOT
6-12x	EW-305691	△ AC CORD 2 CORES KP-8, SPT-1 UC (C,A)	6-30x	ZW-305013	RV POP32
6-13x	EW-313882	△ AC CORD 2 CORES KP-419C, LTCE-2F E (E)	6-31	EF-327103	△ FUSE TSC A 250V 0.50A (F2)(U,J)
6-14x	EW-322400	△ AC CORD 2 CORES GTBS-2F/KS-15 B (B)	6-32	EF-306124	△ FUSE TSC A 250V 0.63A (F3)(U,J)
6-15x	EW-322401	△ AC CORD 2 CORES KP-560/S-15 S (S)	6-33x	EF-309390	△ FUSE TSC 125V 0.50A (F2)(C,A)
6-16x	EW-315767	△ AC CORD 2 CORES KP-419C/KS-15 E (V)	6-34x	EF-305703	△ FUSE TSC 125V 0.63A (F3)(C,A)
6-17x	SZ-631945	STRAIN RELIEF SR-4N-4 (U,J,C,A,E)	6-35x	EF-307178	△ FUSE EAWK T 250V 0.08A (F1)(B)
6-18x	EJ-310567	△ SOCKET INLET 0378PC-GS E 2P (B,S,V)	6-36x	EF-593706	△ FUSE SEMKO T 250V 0.50A (F2) (E,B,S,V)
			6-37x	EF-601942	△ FUSE SEMKO T 250V 0.63A (F3) (E,B,S,V)
			6-38x	EW-318452	CORD RR-163 PIN-PIN/2P

FINAL ASSEMBLY BLOCK

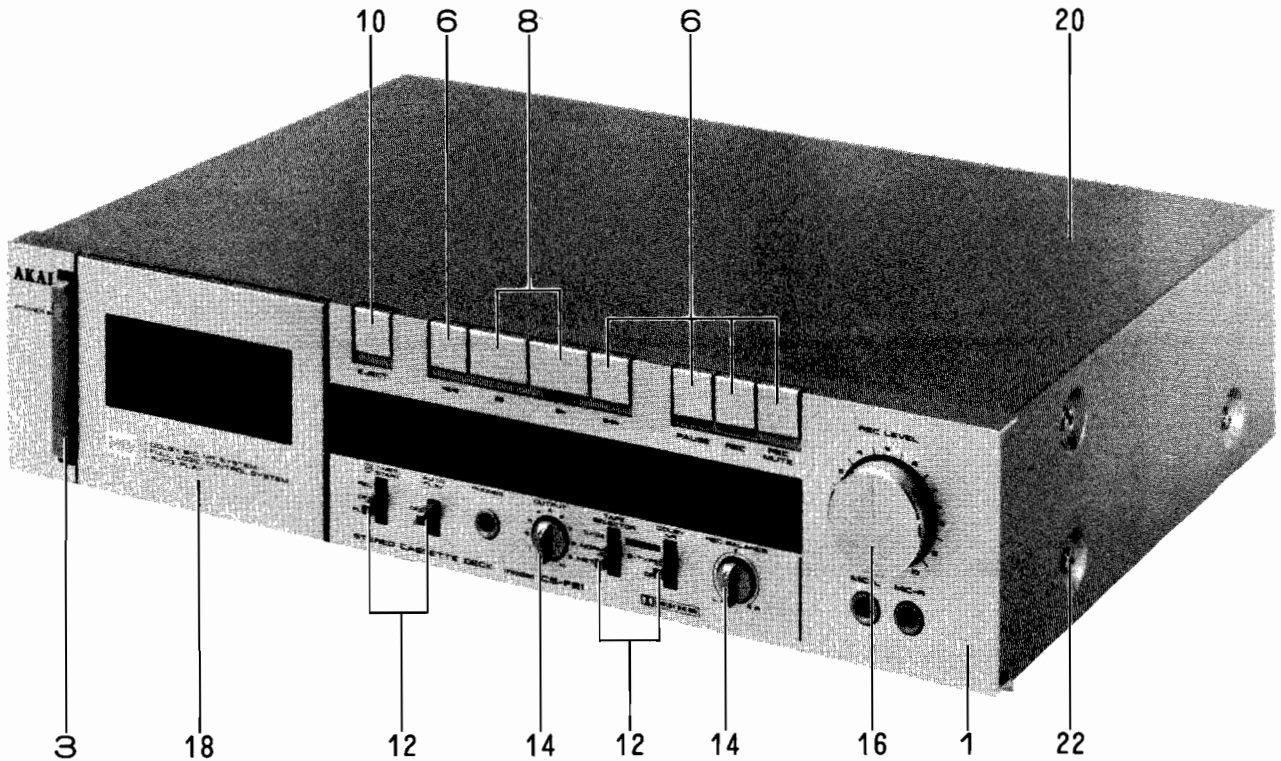

7. FINAL ASSEMBLY BLOCK

REF. NO.	PARTS NO.	DESCRIPTION
FRONT PANEL BLOCK		
7-1	BD-B604435	PANEL FRONT PART
7-2x	BD-B604436	PANEL FRONT (P) PART
7-3	SK-332589A	KNOB POWER
7-4x	SK-332589B	KNOB POWER-P
7-5x	ZG-332762	SP PUSH KNOB
7-6	SK-332627A	KNOB OPERATE (A)
7-7x	SK-332627B	KNOB OPERATE (A)-P
7-8	SK-332619A	KNOB OPERATE (B)
7-9x	SK-332619B	KNOB OPERATE (B)-P
7-10	SK-332799A	KNOB EJECT
7-11x	SK-332799B	KNOB EJECT-P
FINAL ASSEMBLY BLOCK		
7-12	SK-332590B	KNOB SW (A-2)
7-13x	SK-332590C	KNOB SW (A-3)
7-14	SK-332591B	KNOB VR (A-2)
7-15x	SK-332591C	KNOB VR (A-3)
7-16	SK-332592A	KNOB VR (B)
7-17x	SK-332592C	KNOB VR (B-2)-P
7-18	BD-B604432	LID PANEL PART
7-19x	BD-B604433	LID PANEL-P PART
7-20	SP-336654A	COVER UPPER
7-21x	SP-336654B	COVER UPPER-P
7-22	ZS-341959	ST BID40x06STL N13
7-23x	ZS-341960	ST BID40x06STL BNI

When ordering parts, please quote Parts Number, Description and Model Number.

INDEX

1. MODEL CS-F14

PARTS NO.	REF. NO.	PARTS NO.	REF. NO.	PARTS NO.	REF. NO.	PARTS NO.	REF. NO.	PARTS NO.	REF. NO.
BAT2039A030A	2-1	EJ-310567	6-18x	HP-706362	1-6	ZW-706403	1-44		
BAT2039A030B	2-2	EJ-332415	2-J5	HZ-706388	1-29	ZW-706404	1-45		
BAT2039A030C	2-3	EJ-332416	2-J6	MB-706365	1-8				
BAT2039A030D	2-4	EJ-332435	2-J4	MB-706392	1-33				
BD-B332596A3	7-14	EJ-332437	2-J4	MB-706393	1-34				
BD-B332596B3	7-15x	EJ-336782	2-J6	MC-706413	1-52				
BD-B332598A4	7-1	EJ-336783	2-J5	MI-706395	1-36				
BD-B332598B4	7-2x	EM-332427	5-IN1	MP-706359	1-3				
BF-706394	1-35	EO-315758	2-FL1	SA-202118	6-27x				
BM-706361	1-5	EO-321336	2-VL1	SA-336217	6-29x				
BR-706397	1-38	EO-332420	2-T1	SK-332589A	7-3				
BR-706399	1-40	EO-337044	2-FL4	SK-332589B	7-4x				
BT-332227	6-2x	EP-337067	2-RL1	SK-332590B	7-8				
BT-332228	6-1	EP-706360	1-4	SK-332590C	7-9x				
BT-332229	6-3x	EP-706401	1-42	SK-332591B	7-10				
BT-332230	6-4x	ER-307565	2-FR1,2	SK-332591C	7-11x				
BT-332231	6-5x	ER-318430	3-R3	SK-332592A	7-12				
BZ-336355	1-1x	ER-336775	2-FL2	SK-332592C	7-13x				
BZ-706358	1-2	ER-336776	2-FL3	SK-332601A	7-6				
EC-201319	2-C24	ES-312234	6-7	SK-332601B	7-7x				
EC-306017	2-C23	ES-312235	6-9x	SP-336654A	7-16				
EC-306017	2-C101	ES-312238	6-8x	SP-336654B	7-17x				
EC-306018	2-C63	ES-321274	2-SW1	SP-336670H	6-19				
EC-307494	2-C21	ES-332412	2-SW3	SP-336670J	6-20x				
EC-314688	3-C1	ES-332413	2-SW4	SP-336670K	6-21x				
EC-320548	3-C1	ES-336780	4-SW1to6	SP-336670L	6-22x				
EC-325352	2-C84	ES-336781	2-SW2	SP-336670M	6-23x				
EC-326138	2-C85	ES-706400	1-41	SP-336670N	6-25x				
EC-330308	3-C1	ET-200505	2-TR8	SP-336670P	6-24x				
EC-331631	2-C98	ET-200505	2-TR12	SZ-631945	6-17x				
EC-341675	2-C87	ET-200505	2-TR19,20	TC-706366	1-9				
EC-427948	2-C93	ET-200505	2-TR22	TC-706367	1-10				
EC-427948	2-C97	ET-200505	2-TR25	TC-706368	1-11				
ED-200468	2-D2,3	ET-200505	2-TR27,28	TC-706369	1-12				
ED-200468	2-D9,10	ET-200505	2-TR33	TC-706370	1-13				
ED-200468	2-D12	ET-200505	2-TR36	TC-706371	1-14				
ED-200468	2-D16	ET-200505	2-TR3	TC-706387	1-28				
ED-200468	2-D20to22	ET-200505	3-TR1	TC-706389	1-30				
ED-200468	2-D33,34	ET-200558	2-TR17	TC-706390	1-31				
ED-200468	2-D39	ET-200558	2-TR29	TC-706391	1-32				
ED-200468	2-D42,43	ET-308937	2-TR30	TC-706396	1-37				
ED-200469	2-D1	ET-309353	2-TR13	TC-706398	1-39				
ED-200469	2-D4to8	ET-309353	2-TR23,24	TC-706406	1-47				
ED-308952	2-D37	ET-311977	2-PH1	TC-706407	1-48				
ED-316540	3-D3	ET-317919	2-TR26	TC-706409	1-49				
ED-322238	3-D1,2	ET-317919	3-TR2	TC-706412	1-51				
ED-322982	2-D19	ET-328437	2-TR21	ZG-332762	7-5x				
ED-322982	2-D23	ET-332421	2-TR35	ZG-706372	1-15				
ED-322982	2-D35,36	ET-332422	2-TR1,2	ZG-706373	1-16				
ED-323979	2-D11	ET-332424	2-TR4to6	ZG-706374	1-17				
ED-323979	2-D13,14	ET-603257	2-TR10,11	ZG-706376	1-18				
ED-323979	2-D38	ET-603257	2-TR14to16	ZG-706377	1-19				
ED-328605	2-D17,18	ET-603257	2-TR31	ZG-706378	1-20				
ED-329058	2-D40	EV-315413	2-VR1	ZG-706379	1-21				
ED-332243	4-D1	EV-315414	2-VR3	ZG-706380	1-22				
ED-337295	2-D41	EV-315416	2-VR4	ZG-706381	1-23				
EF-305703	6-34x	EV-322413	2-VR5	ZG-706382	1-24				
EF-306124	6-32	EV-322416	2-VR2	ZG-706383	1-25				
EF-307178	6-35x	EV-336785	2-VR6	ZG-706384	1-26				
EF-309390	6-33x	EV-337068	2-VR8	ZG-706385	1-27				
EF-327103	6-31	EV-337193	2-VR1	ZG-706405	1-46				
EF-593706	6-36x	EW-305691	6-12x	ZG-706411	1-50				
EF-601942	6-37x	EW-306427	6-11x	ZG-706414	1-53				
EI-304657	2-IC3	EW-306428	6-10	ZS-312116	6-6				
EI-305456	2-IC2	EW-313882	6-13x	ZS-331567	6-26x				
EI-315799	5-IC1	EW-315767	6-16x	ZS-331567	6-28x				
EI-332425	2-IC1	EW-318452	6-38x	ZS-341959	7-18				
EI-336983	2-IC4	EW-322400	6-14x	ZS-341960	7-19x				
EI-338353	3-IC1	EW-322401	6-15x	ZW-305013	6-30x				
EJ-283140	3-VS1	HE-706363	1-7	ZW-706402	1-43				

2. MODEL CS-F21

PARTS NO.	REF. NO.	PARTS NO.	REF. NO.	PARTS NO.	REF. NO.	PARTS NO.	REF. NO.	PARTS NO.	REF. NO.
BAT2037A030A	2-1	EI-336983	2-IC4	EW-315767	6-16x	ZG-706411	1-50		
BAT2037A030B	2-2	EI-338353	3-IC1	EW-318452	6-38x	ZG-706414	1-53		
BAT2037A030C	2-3	EJ-283140	3-VS1	EW-322400	6-14x	ZS-312116	6-6		
BAT2037A030D	2-4	EJ-310567	6-18x	EW-322401	6-15x	ZS-331567	6-26x		
BD-B604432	7-18	EJ-332415	2-J5	HE-706363	1-7	ZS-331567	6-28x		
BD-B604433	7-19x	EJ-332416	2-J6	HP-706362	1-6	ZS-341959	7-22		
BD-B604435	7-1	EJ-332435	2-J4	HZ-706388	1-29	ZS-341960	7-23x		
BD-B604436	7-2x	EJ-332437	2-J4	MB-706365	1-8	ZW-305013	6-30x		
BF-706394	1-35	EJ-336782	2-J6	MB-706392	1-33	ZW-706402	1-43		
BM-706361	1-5	EJ-336783	2-J5	MB-706393	1-34	ZW-706403	1-44		
BR-706397	1-38	EJ-337654	2-J3	MC-706413	1-52	ZW-706404	1-45		
BR-706399	1-40	EM-332427	5-IN1	MI-706395	1-36				
BT-332227	6-2x	EO-315758	2-FL1	MP-706359	1-3				
BT-332228	6-1	EO-321336	2-VL1	SA-202118	6-27x				
BT-332229	6-3x	EO-332420	2-T1	SA-336217	6-29x				
BT-332230	6-4x	EO-337044	2-FL4	SK-332589A	7-3				
BT-332231	6-5x	EP-337067	2-RL1	SK-332589B	7-4x				
BZ-336355	1-1x	EP-706360	1-4	SK-332590B	7-12				
BZ-706358	1-2	EP-706401	1-42	SK-332590C	7-13x				
EC-201319	2-C24	ER-307565	2-FR1,2	SK-332591B	7-14				
EC-306017	2-C23	ER-318430	3-R3	SK-332591C	7-15x				
EC-306017	2-C101	ER-336775	2-FL2	SK-332592A	7-16				
EC-306018	2-C63	ER-336776	2-FL3	SK-332592C	7-17x				
EC-307494	2-C21	ES-312234	6-7	SK-332619A	7-8				
EC-314688	3-C1	ES-312235	6-9x	SK-332619B	7-9x				
EC-320548	3-C1	ES-312238	6-8x	SK-332627A	7-6				
EC-325352	2-C84	ES-321274	2-SW1	SK-332627B	7-7x				
EC-326138	2-C85	ES-332412	2-SW3	SK-332799A	7-10				
EC-330308	3-C1	ES-332413	2-SW4	SK-332799B	7-11x				
EC-331631	2-C98	ES-336781	2-SW2	SP-336654A	7-20				
EC-341675	2-C87	ES-706400	1-41	SP-336654B	7-21x				
EC-427948	2-C97	ET-200505	2-TR8	SP-336670Q	6-19				
EC-427948	2-C93	ET-200505	2-TR12	SP-336670R	6-20x				
ED-200468	2-D2,3	ET-200505	2-TR19,20	SP-336670S	6-21x				
ED-200468	2-D9,10	ET-200505	2-TR22	SP-336670T	6-22x				
ED-200468	2-D12	ET-200505	2-TR25	SP-336670U	6-23x				
ED-200468	2-D16	ET-200505	2-TR27,28	SP-336670V	6-25x				
ED-200468	2-D20to22	ET-200505	2-TR32to34	SP-336670W	6-24x				
ED-200468	2-D31to34	ET-200505	2-TR36	SZ-631945	6-17x				
ED-200468	2-D39	ET-200505	2-TR3	TC-706366	1-9				
ED-200468	2-D42,43	ET-200505	3-TR1	TC-706367	1-10				
ED-200469	2-D1	ET-200558	2-TR17	TC-706368	1-11				
ED-200469	2-D4to8	ET-200558	2-TR29	TC-706369	1-12				
ED-308952	2-D37	ET-308937	2-TR7	TC-706370	1-13				
ED-316540	3-D3	ET-308937	2-TR30	TC-706371	1-14				
ED-322238	3-D1,2	ET-309353	2-TR13	TC-706387	1-28				
ED-322982	2-D19	ET-309353	2-TR23,24	TC-706389	1-30				
ED-322982	2-D23	ET-311977	2-PH1	TC-706390	1-31				
ED-322982	2-D35,36	ET-317919	2-TR26	TC-706391	1-32				
ED-323979	2-D11	ET-317919	3-TR2	TC-706396	1-37				
ED-323979	2-D13,14	ET-328437	2-TR21	TC-706398	1-39				
ED-323979	2-D38	ET-332421	2-TR35	TC-706406	1-47				
ED-328605	2-D15	ET-332422	2-TR1,2	TC-706407	1-48				
ED-328605	2-D17,18	ET-332424	2-TR4to6	TC-706409	1-49				
ED-329058	2-D40	ET-603257	2-TR10,11	TC-706412	1-51				
ED-332243	4-D1	ET-603257	2-TR14to16	ZG-332762	7-5x				
ED-332244	4-D3	ET-603257	2-TR31	ZG-706372	1-15				
ED-336786	4-D2	EV-315413	2-VR1	ZG-706373	1-16				
ED-337295	2-D41	EV-315414	2-VR3	ZG-706374	1-17				
EF-305703	6-34x	EV-315416	2-VR4	ZG-706376	1-18				
EF-306124	6-32	EV-322413	2-VR5	ZG-706377	1-19				
EF-307178	6-35x	EV-322416	2-VR2	ZG-706378	1-20				
EF-309390	6-33x	EV-336785	2-VR6	ZG-706379	1-21				
EF-327103	6-31	EV-337068	2-VR8	ZG-706380	1-22				
EF-593706	6-36x	EV-337192	2-VR7	ZG-706381	1-23				
EF-601942	6-37x	EV-337193	2-VR1	ZG-706382	1-24				
EI-304657	2-IC3	EW-305691	6-12x	ZG-706383	1-25				
EI-305456	2-IC2	EW-306427	6-11x	ZG-706384	1-26				
EI-315799	5-IC1	EW-306428	6-10	ZG-706385	1-27				
EI-332425	2-IC1	EW-313882	6-13x	ZG-706405	1-46				

SECTION 3

SCHEMATIC DIAGRAM

1. SCHEMATIC DIAGRAM OF ICs
2. CS-F14 No. 1640646A SCHEMATIC DIAGRAM
3. CS-F21 No. 1640654A SCHEMATIC DIAGRAM

HA12019

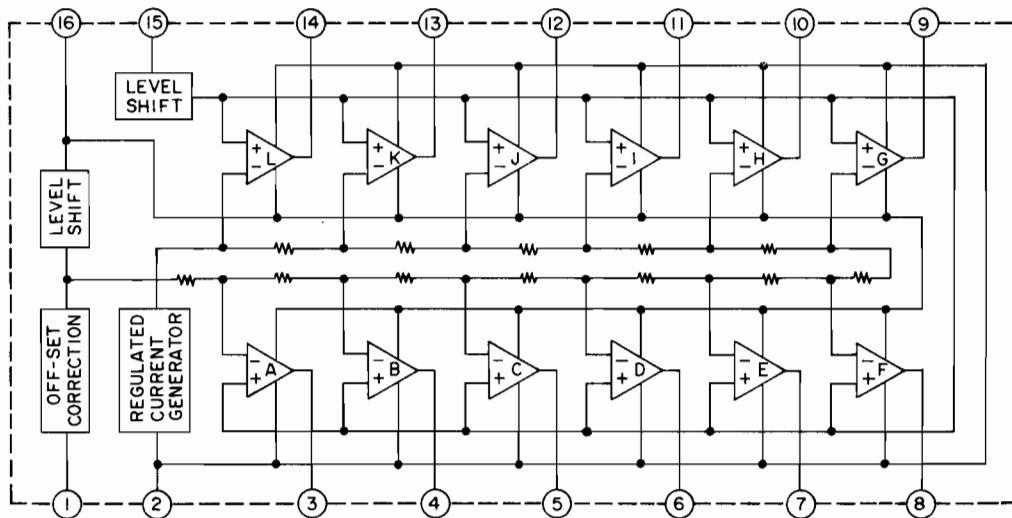

HA12038

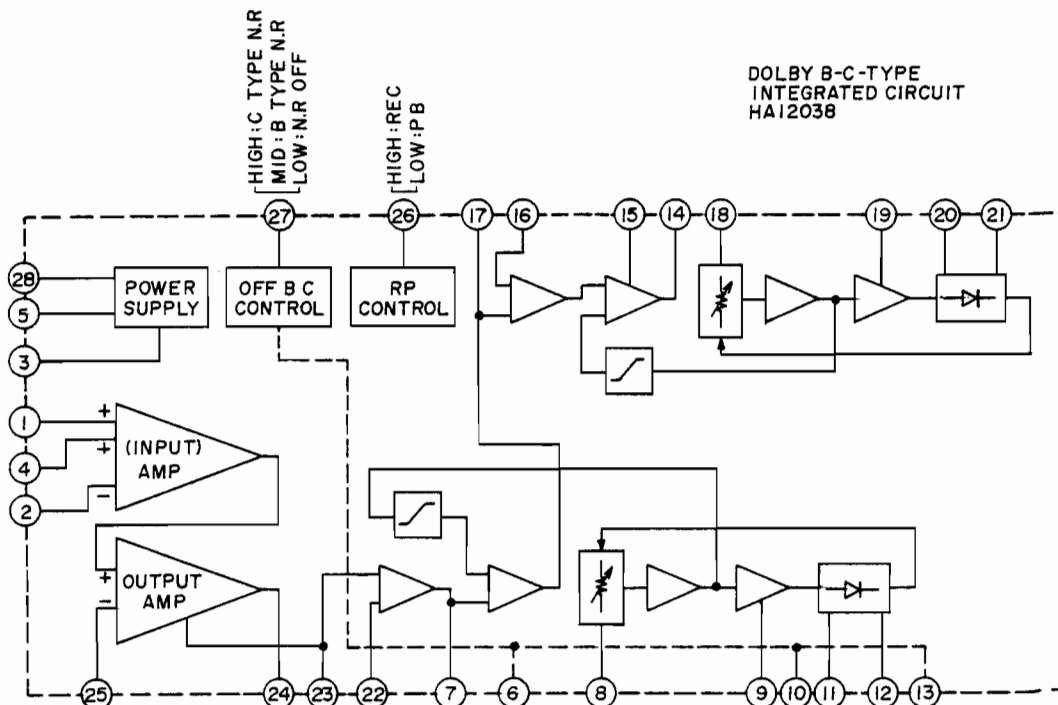

TC4011BP

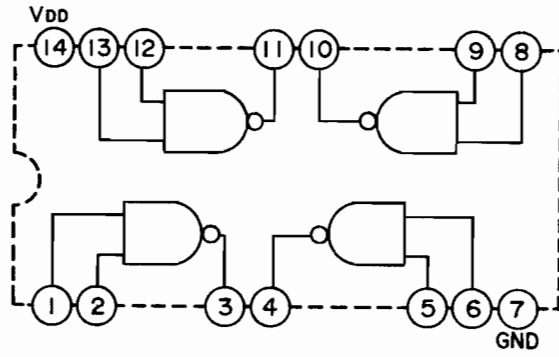

TC4049BP

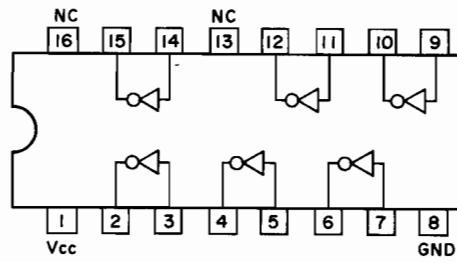

TK11002

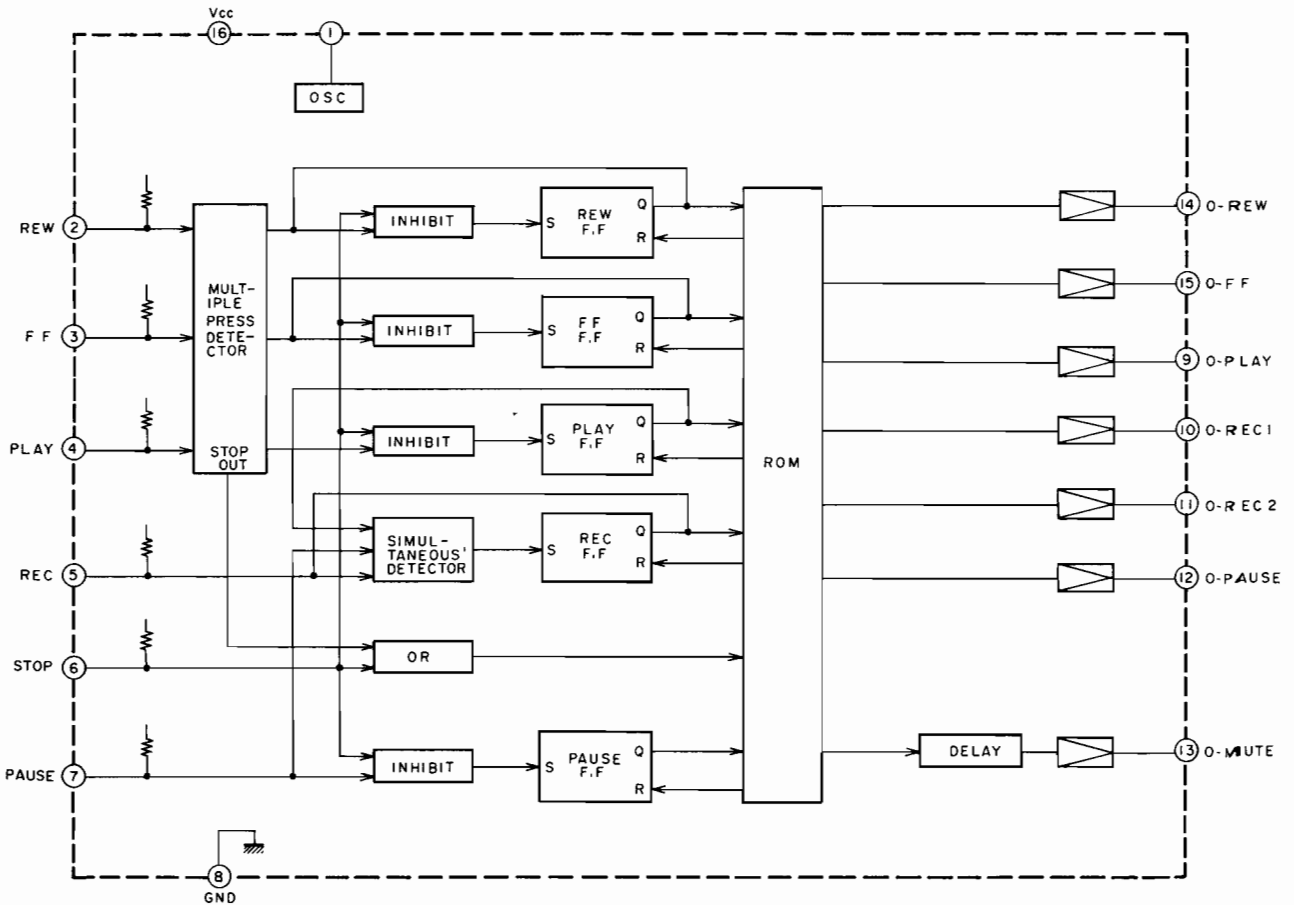

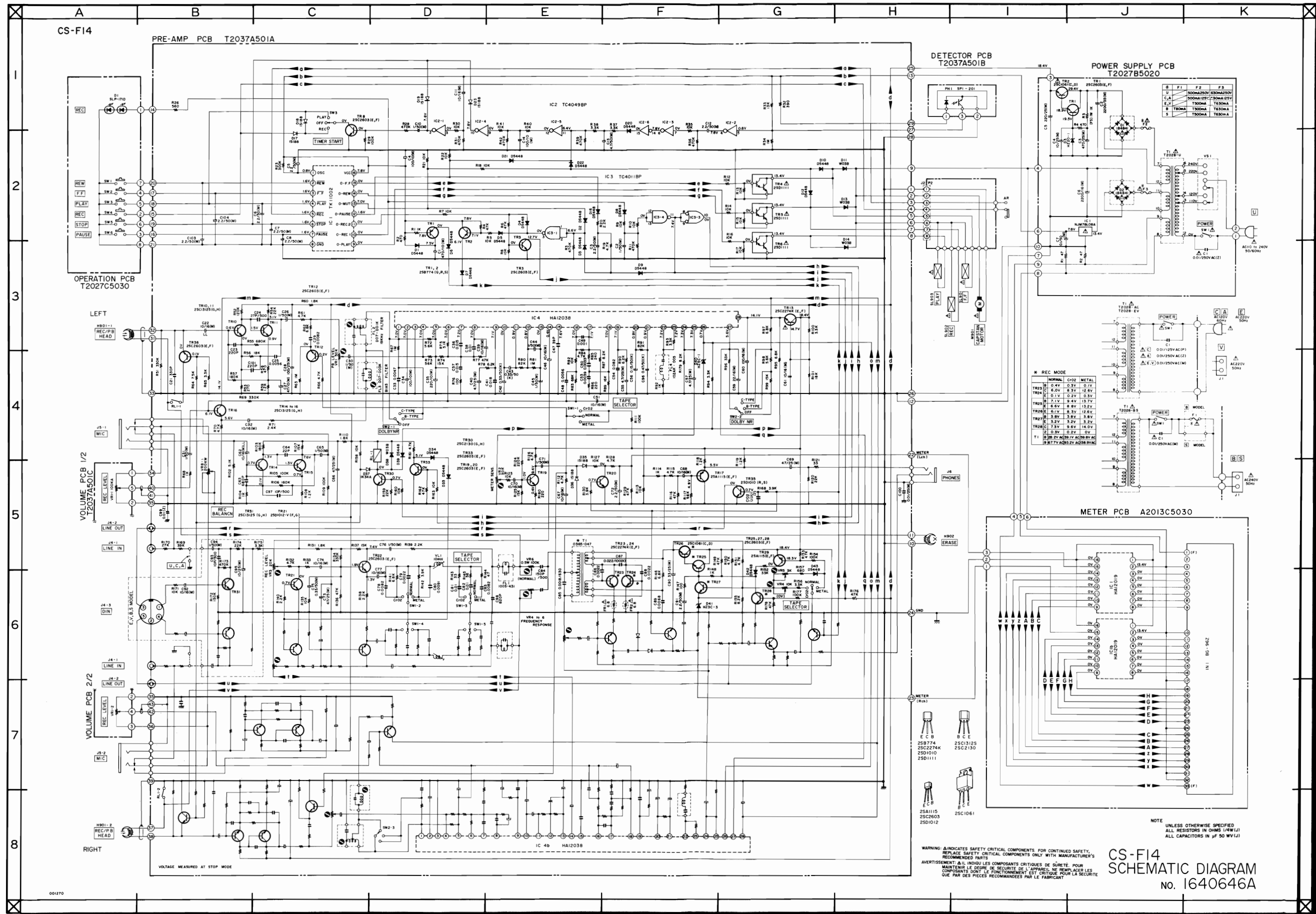

CS-F14
SCHEMATIC DIAGRAM
No. 1640646A

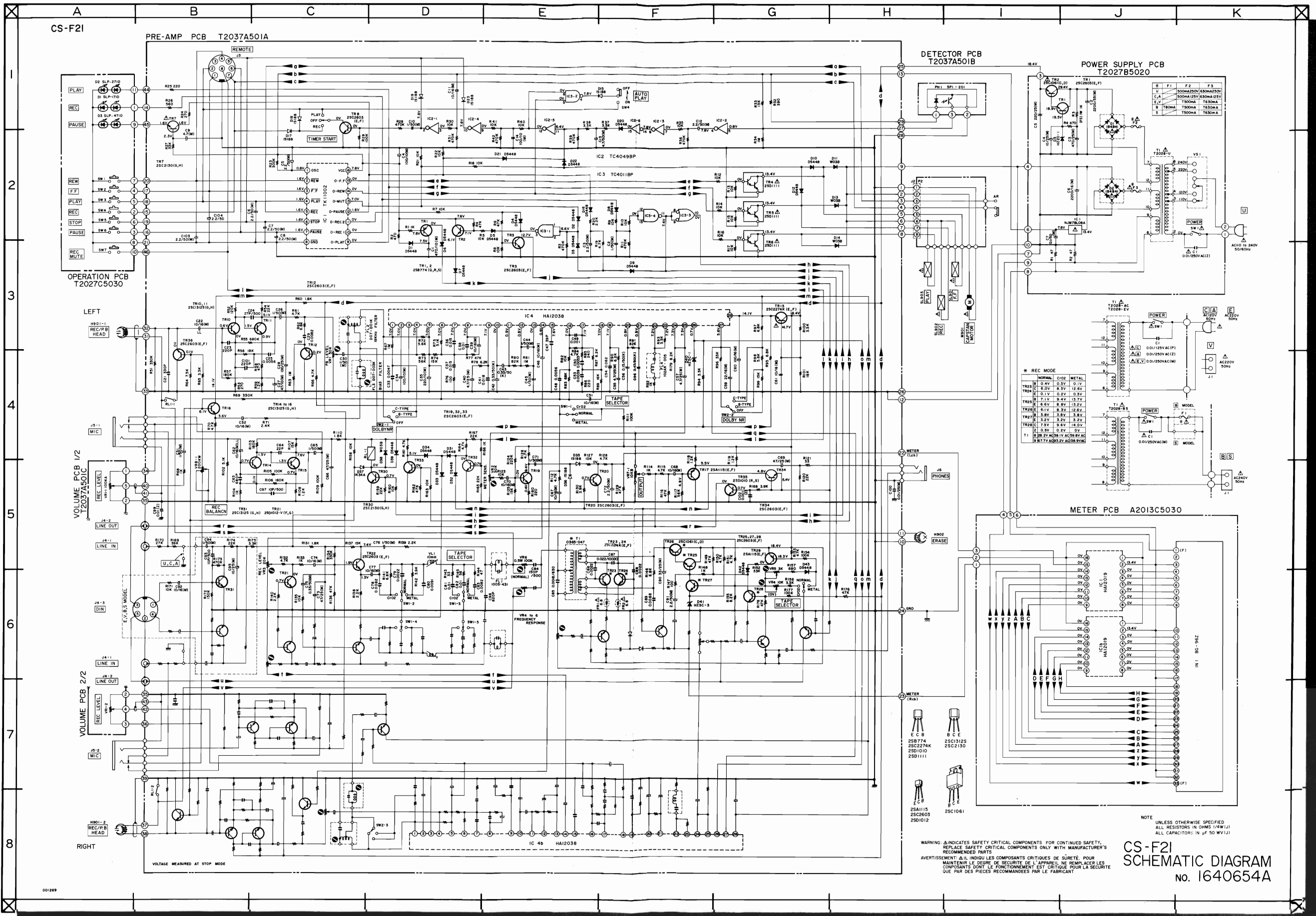

* REC MODE

TR	TYPE	C102	METAL
TR1	0.4V	0.3V	0.1V
TR2	0.2V	0.3V	0.3V
TR3	0.1V	0.2V	0.3V
TR4	0.1V	0.4V	0.3V
TR5	0.6V	0.8V	0.3V
TR6	0.1V	0.3V	0.2V
TR7	0.3V	0.2V	0.3V
TR8	0.3V	0.4V	0.3V
TR9	0.3V	0.4V	0.3V
TR10	0.3V	0.4V	0.3V
TR11	0.3V	0.4V	0.3V
TR12	0.3V	0.4V	0.3V
TR13	0.3V	0.4V	0.3V
TR14	0.3V	0.4V	0.3V
TR15	0.3V	0.4V	0.3V
TR16	0.3V	0.4V	0.3V
TR17	0.3V	0.4V	0.3V
TR18	0.3V	0.4V	0.3V
TR19	0.3V	0.4V	0.3V
TR20	0.3V	0.4V	0.3V
TR21	0.3V	0.4V	0.3V
TR22	0.3V	0.4V	0.3V
TR23	0.3V	0.4V	0.3V
TR24	0.3V	0.4V	0.3V
TR25	0.3V	0.4V	0.3V
TR26	0.3V	0.4V	0.3V
TR27	0.3V	0.4V	0.3V
TR28	0.3V	0.4V	0.3V
TR29	0.3V	0.4V	0.3V
TR30	0.3V	0.4V	0.3V
TR31	0.3V	0.4V	0.3V
TR32	0.3V	0.4V	0.3V
TR33	0.3V	0.4V	0.3V
TR34	0.3V	0.4V	0.3V
TR35	0.3V	0.4V	0.3V
TR36	0.3V	0.4V	0.3V
TR37	0.3V	0.4V	0.3V
TR38	0.3V	0.4V	0.3V
TR39	0.3V	0.4V	0.3V
TR40	0.3V	0.4V	0.3V
TR41	0.3V	0.4V	0.3V
TR42	0.3V	0.4V	0.3V
TR43	0.3V	0.4V	0.3V
TR44	0.3V	0.4V	0.3V
TR45	0.3V	0.4V	0.3V
TR46	0.3V	0.4V	0.3V
TR47	0.3V	0.4V	0.3V
TR48	0.3V	0.4V	0.3V
TR49	0.3V	0.4V	0.3V
TR50	0.3V	0.4V	0.3V

NOTE
UNLESS OTHERWISE SPECIFIED
ALL RESISTORS IN OHMS (1/4W 1%)
ALL CAPACITORS IN µF (50 WV 1%)

WARNING: Δ INDICATES SAFETY CRITICAL COMPONENTS FOR CONTINUED SAFETY.
REPLACE SAFETY CRITICAL COMPONENTS ONLY WITH MANUFACTURER'S
RECOMMENDED PARTS

AVERTISSEMENT: Δ IL INDIQUE LES COMPOSANTS CRITIQUES DE SÛRETÉ POUR
MAINTENIR LE DEGRÉ DE SÛRETÉ DE L'APPAREIL. NE REMPLACER LES
COMPOSANTS DONT LE FONCTIONNEMENT EST CRITIQUE POUR LA SÛRETÉ
QUE PAR DES PIÈCES RECOMMANDÉES PAR LE FABRICANT.

CS-F21
SCHEMATIC DIAGRAM
No. 1640654A