

# AKAI SERVICE MANUAL

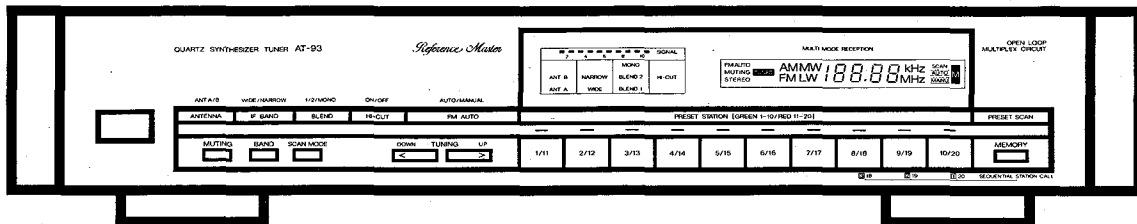

## QUARTZ SYNTHESIZER TUNER

## MODEL AT-93/L

### SPECIFICATIONS

#### FM section

Tuning frequency range	87.5 MHz to 108.0 MHz
Usable sensitivity	1.0 $\mu$ V (11.2 dBf)
Quieting sensitivity (S/N = 50 dB)	
Mono	2.0 $\mu$ V (17.2 dBf)
Stereo	22 $\mu$ V (38.2 dBf)
Capture ratio (Wide)	1.3 dB
Selectivity ( $\pm$ 400 kHz)	
Wide	60 dB
Narrow	90 dB
Image rejection ratio	90 dB
IF rejection ratio	100 dB
Spurious rejection ratio	65 dB
Sub carrier suppression ratio	70 dB
S/N	
Mono (IHF-A)	90 dB (at 80 dB $\mu$ )
Stereo (IHF-BPF)	80 dB (at 60 dB $\mu$ )
	86 dB (at 80 dB $\mu$ )
Distortion (T.H.D., at 1 kHz)	
Wide	0.02% (Mono)/0.07% (Stereo)
Narrow	0.08% (Mono)/0.3% (Stereo)
Stereo separation (at 1 kHz)	62 dB (Wide)/55 dB (Narrow)
Frequency response	0 $\pm$ 0.5 dB (50 Hz to 15 kHz)

#### AM section (MW for AT-93/L)

Tuning frequency range	
For USA and Canada	530 kHz to 1,610 kHz
For other countries	531 kHz to 1,602 kHz
Sensitivity (Loop antenna)	300 $\mu$ V/m
Selectivity	
USA and Canada	50 dB ( $\pm$ 10 kHz)
Other countries	40 dB ( $\pm$ 9 kHz)
Image rejection ratio	40 dB
IF rejection ratio	60 dB
S/N	45 dB
Distortion (T.H.D.)	0.6 dB

#### LW section (AT-93L only)

Tuning frequency range	144 kHz to 351 kHz
Sensitivity	300 $\mu$ V/m
Selectivity	55 dB ( $\pm$ 9 kHz)
Image rejection ratio	45 dB
IF rejection ratio	37 dB
S/N	40 dB
Distortion (T.H.D.)	0.6%

#### Output level

FM	770 mV (at 100% modulation)
AM (MW for AT-93/L)	250 mV (at 30% modulation)
Hi-cut filter	-6 dB/10 kHz

#### Blend (Separation at 1 kHz)

Blend 1	20 dB
Blend 2	10 dB
Power requirements	120 V, 60 Hz for USA and Canada

220 V, 50 Hz for Europe except UK  
240 V, 50 Hz for UK and Australia

110 - 120 V/220 - 240 V, 50/60 Hz convertible for other countries

Dimensions . . . . . 461 (W)  $\times$  87 (H)  $\times$  344 (D) mm

(18.1  $\times$  3.4  $\times$  13.5 inches)

Weight . . . . . 6.3 kg (13.9 lbs)

\* For improvement purposes, specifications and design are subject to change without notice.

# ★ SAFETY INSTRUCTIONS

## PRECAUTIONS DURING SERVICING

- Parts identified by the  $\Delta$  symbol parts are critical for safety. Replace only with parts number specified.
- In addition to safety, other parts and assemblies are specified for conformance with such regulations as those applying to spurious radiation. These must also be replaced only with specified replacements.  
Examples: RF converters, tuner units, antenna selector switches, RF cables, noise blocking capacitors, noise blocking filters, etc.
- Use specified internal wiring. Note especially:
  - Wires covered with PVC tubing
  - Double insulated wires
  - High voltage leads
- Use specified insulating materials for hazardous live parts. Note especially:
  - Insulation Tape
  - PVC tubing
  - Spacers (Insulating Barriers)
  - Insulation sheets for transistors
  - Plastic screws for fixing microswitch (especially in turntable)
- When replacing AC primary side components (transformers, power cords, noise blocking capacitors, etc.), wrap ends of wires securely about the terminals before soldering.

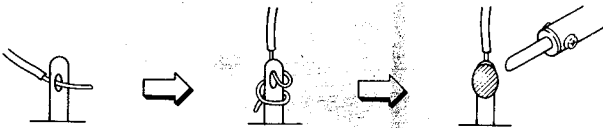

- Observe that wires do not contact heat producing parts (heatsinks, oxide metal film resistors, fusible resistors, etc.).

- Check that replaced wires do not contact sharp edged or pointed parts.
- Also check areas surrounding repaired locations.
- Use care that foreign objects (screws, solder droplets, etc.) do not remain inside the set.

## SAFETY CHECK AFTER SERVICING

Confirm the specified insulation resistance between power cord plug prongs and externally exposed parts of the set is greater than 10 M ohms. but for equipment with external antenna terminals (tuner, receiver, etc.) and is intended for [C] or [A], specified insulation resistance should be headphone jacks line-in-out jacks etc. more than 2.2 M ohms (ground terminals, microphone jacks).

## PRECAUTIONS FOR LITHIUM BATTERY

The lithium battery may explode when heated excessively.

### [OBSERVE THE FOLLOWING WHEN REPLACING]

- Replace with the same make and type only.
- Use soldering iron in "recommended way" only.
- Place battery in correct polarity.
- Do not short the terminals.
- Do not recharge battery.
- Do not dispose of battery in fire.

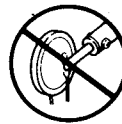

[DANGER]



[RECOMMENDED WAY]

# ★ INFORMATION

## SYMBOLS FOR PRIMARY DESTINATION

Alphabet indicates the destination of the units as listed below.

Symbols	Principal Destinations
[A]	USA
[B]	UK
[C]	Canada
[E]	Europe (except UK)
[J]	Japan
[S]	Australia
[V]	W. Germany only
[U]	Universal Area
[Y*]	Custom version

## VOLTAGE CONVERSION ( [U] Model only)

Before connecting the power cord. SET the VOLTAGE SELECTOR located on the rear panel with a screwdriver so that the correct voltage is indicated.

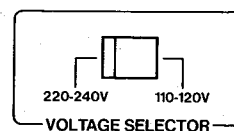

## II. DISASSEMBLY

In case of trouble, etc. necessitating dismantling, please dismantle in the order shown in the photographs. Reassemble in reverse order.

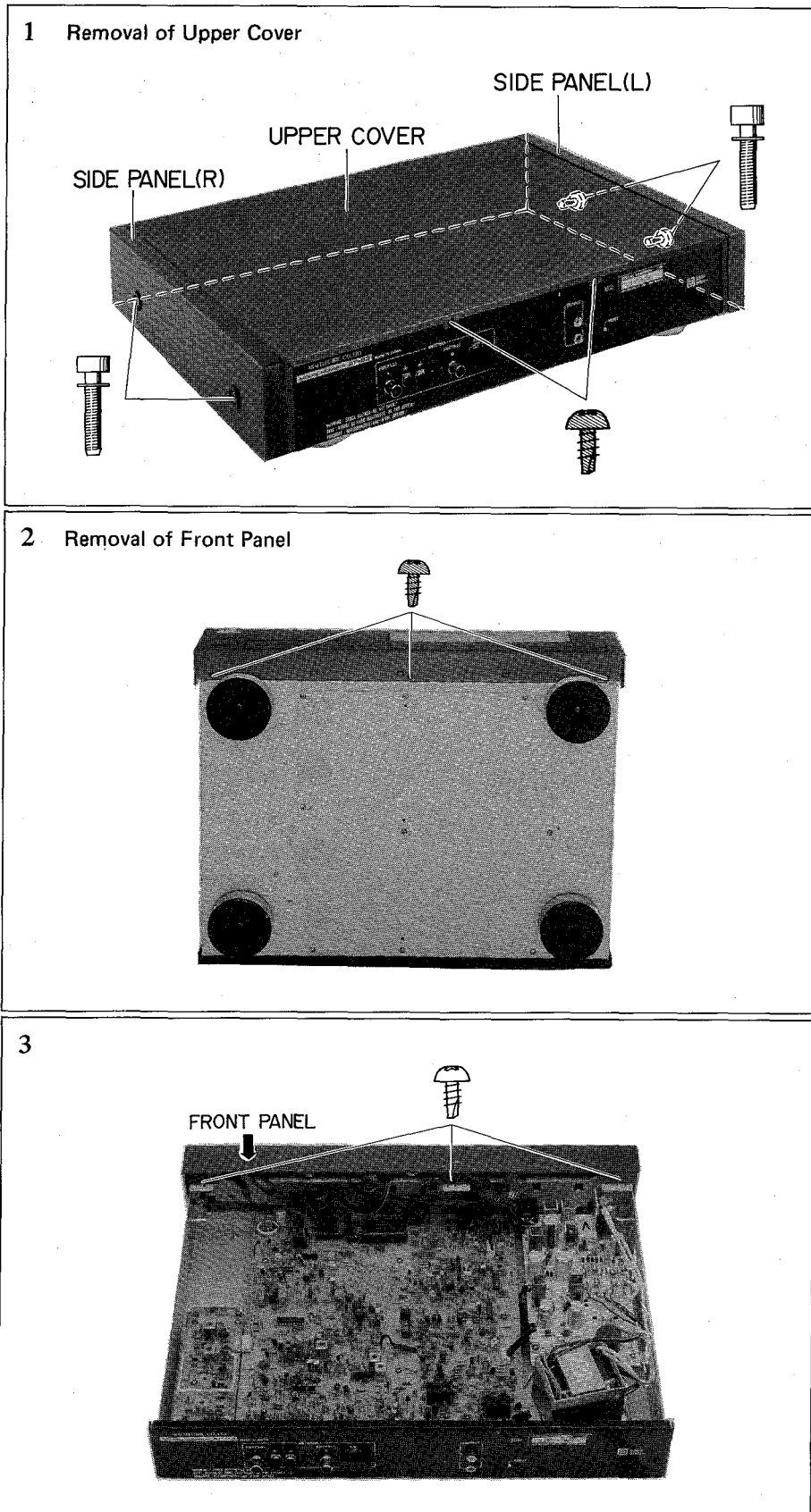

# I. CONTROLS

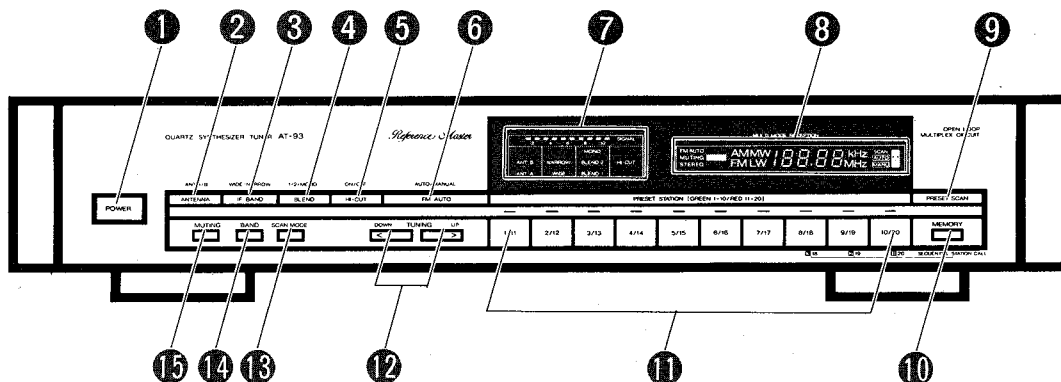

- 1 POWER Switch**  
To turn the power on and off.
- 2 ANTENNA Select button**  
To select the main or sub FM antenna.
- 3 IF BAND Select button**  
To select the wide or narrow FM IF (Intermediate Frequency) band.
- 4 BLEND select button**  
To select the blend mode during FM stereo reception.
- 5 HI-CUT button**  
To turn the high cut filter on or off during reception.
- 6 FM AUTO button**  
To set the tuner to the automatic FM reception mode.
- 7 LED (Light Emitting Diode) Indicators**  
Tells you which mode the tuner is in.
- 8 FL (Fluorescent) Display**  
Shows tuning information.
- 9 PRESET SCAN button**  
To set the tuner to the automatic preset station scan mode.
- 10 MEMORY button**  
To memorize preset stations. Press the button once to memorize preset station numbers 1 to 10. Press the button twice to memorize preset station numbers 11 to 20.
- 11 PRESET STATION Buttons and Indicators (1/11 to 10/20)**  
To memorize preset stations and tune in memorized stations.
- 12 TUNING buttons (UP >/DOWN <)**  
To tune in a station manually.
- 13 SCAN MODE Select button**  
To select the manual or automatic tuning mode.
- 14 BAND Select Button**  
To select the band.
- 15 MUTING button**  
To cut inter-station noise during tuning.

## LED Indicators

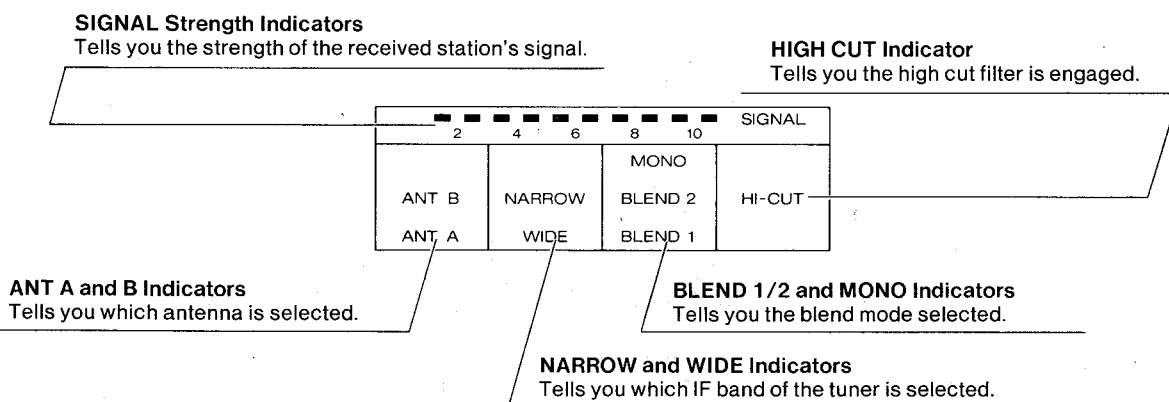

# IV. ADJUSTMENT

## 4-1. INSTRUMENT CONNECTIONS

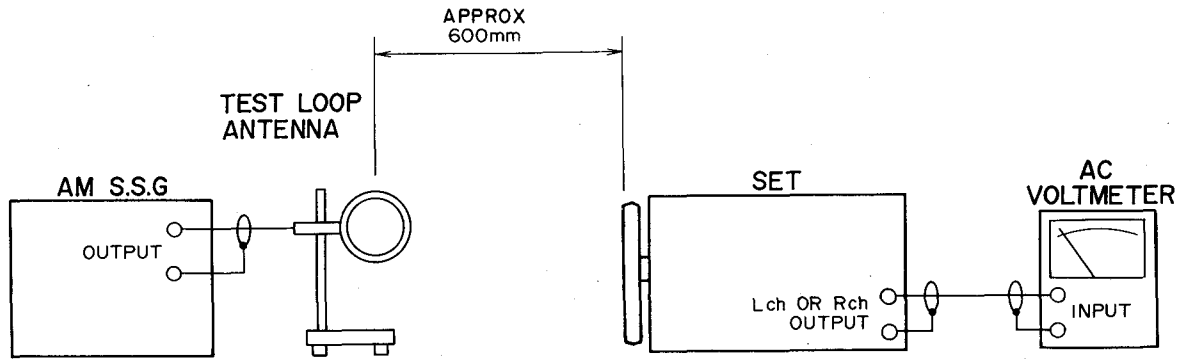

Fig. 4-1 Instrument Connection for AM (MW, LW) Section Adjustment

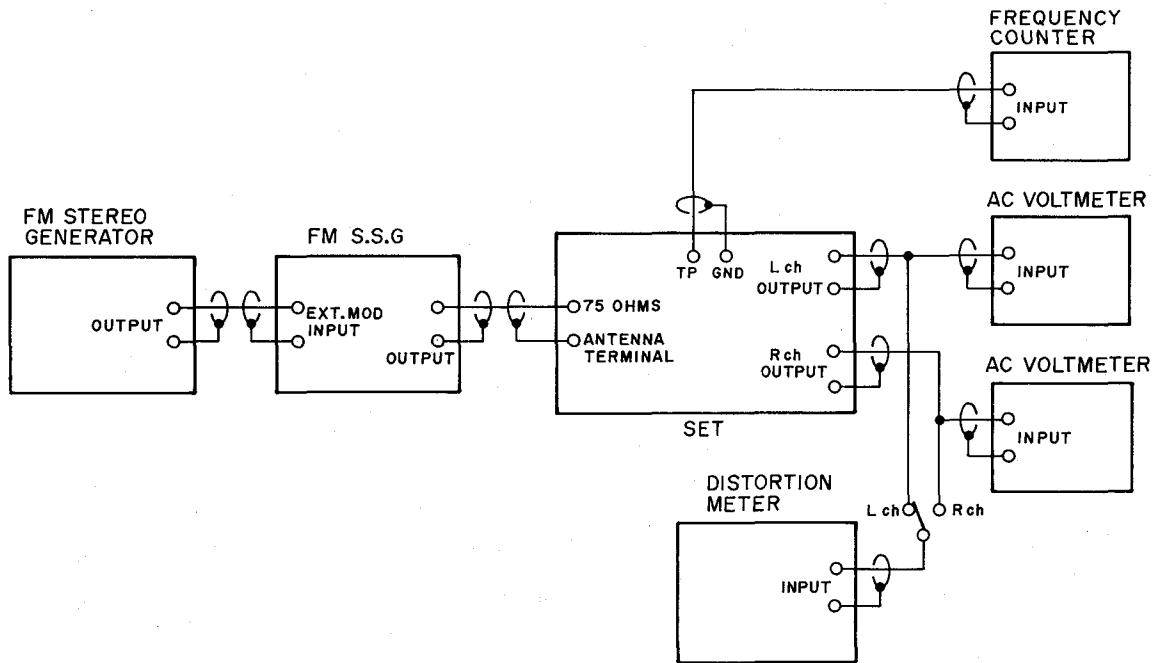
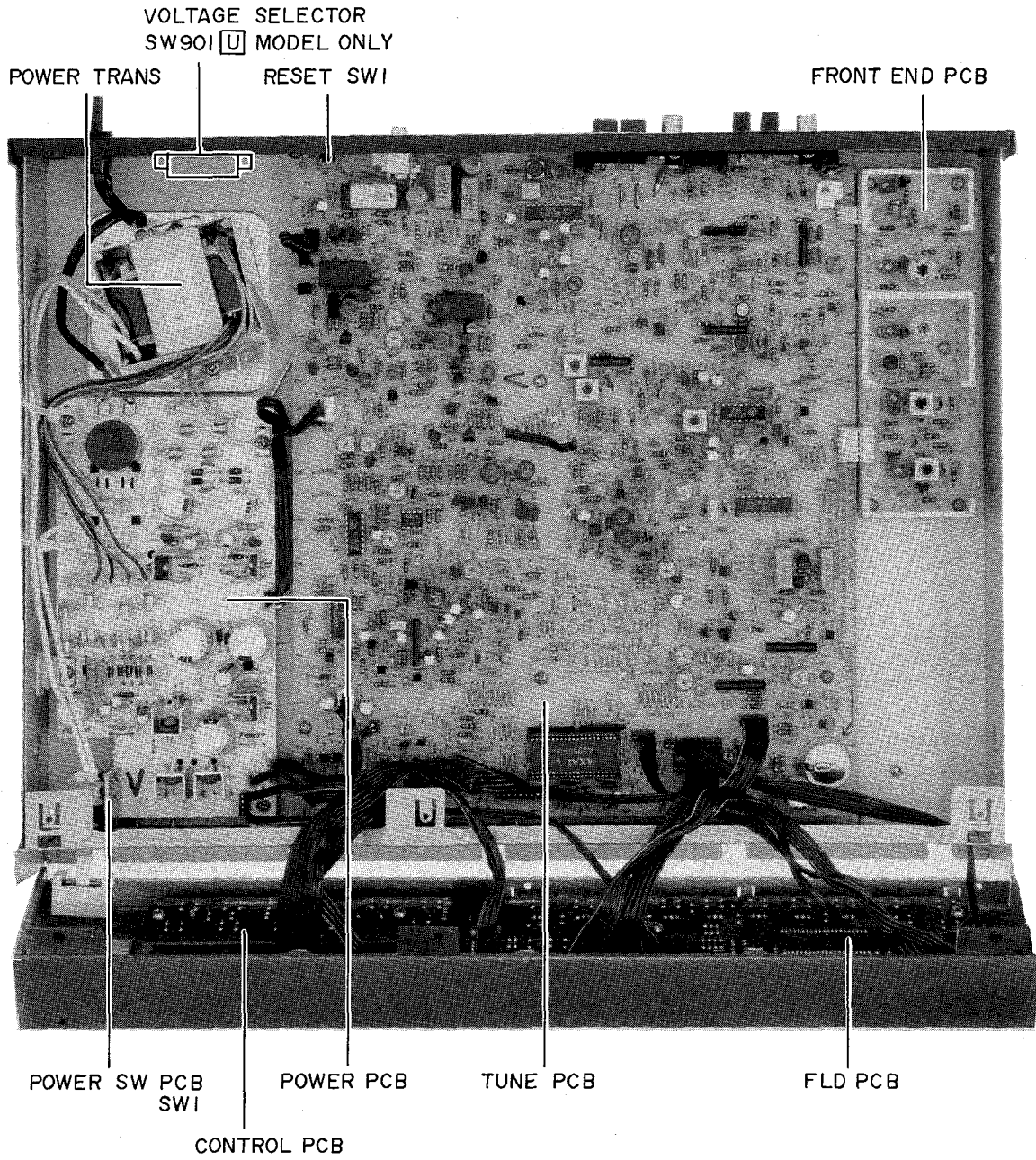

Fig. 4-2 Instrument Connection for FM Section Adjustment

### III. PRINCIPAL PARTS LOCATION



#### 4-4. FM SECTION ADJUSTMENT

**NOTE:** 1. Set the S.S.G to 1 kHz, 75 kHz deviation for [A], [C], [U] model, 1 kHz 40kHz deviation for [B], [E] or [V] model.  
 2. Set the MUTE SW to OFF and IF Band SW to WIDE without notice.  
 3. Confirm that the Sensitivity margin between Low and High range sensitivities is within 3 dB, otherwise readjust Low and High range sensitivity.

STEP	ADJUSTMENT ITEM
1.	SSG FREQ. & OUTPUT LEVEL
2.	SET Tuning FREQ.
3.	Test Point & ADJ. Part
4.	Result & Remarks

Adjustment Part  
 Test Point

FM10	SIGNAL INDICATOR LEVEL
1.	98MHz
2.	98MHz (IF-BAND: WIDE, BLEND & Hi-CUT: "OFF")
3.	SIGNAL METER on the Front panel. VR2, VR12, VR11
4.	Adjust VR2 so that 1st in LED light when 22dBμ input level. • Change the input level from S.S.G so that the 3rd LED is light, then set to MONO mode. • Change the Input level from S.S.G to 60dBμ and Adjust TR11 so that the 5th LED is light. * At this time, confirm so that the indicator does not change at STEREO and MONO. • Same condition as in above, change IF-BAND to "NARROW", and adjust VR1 so that the 5th LED is light.

FM12	DC BALANCE
1.	98MHz, 60dBμ
2.	98MHz
3.	Connect the digital DC Voltmeter to OUTPUT. VR10 (L CH.), VR9 (R CH.)
4.	Less than 1mV.

FM9	CHANNEL SEPARATION
1.	98MHz, 60dBμ (STEREO L or R channel only)
2.	98MHz (IF-BAND: WIDE, BLEND & Hi-CUT: "OFF")
3.	Connect the milli voltmeters to both L & R channels LINE OUT. WIDE mode: VR6, VR7 NARROW mode: VR8
4.	Leakage of signal L → R or R → L are minimum. WIDE mode: less than 55dB NARROW mode: less than 40dB

FM7	PILOT CANCEL
1.	98MHz, 60dBμ (STEREO, PILOT only)
2.	98MHz, (IF-BAND: WIDE, BLEND & Hi-CUT: "OFF")
3.	Connect the oscilloscope and milli voltmeter to LINE OUT. VR5
4.	Leakage of pilot signal is minimum, leakage level of L and R channels should be same and less than -60dB.

FM6	19kHz PHASE
1.	98MHz, 60dBμ (STEREO, PILOT only)
2.	98MHz (IF-BAND: WIDE, BLEND & Hi-CUT: "OFF")
3.	Connect the oscilloscope between rear side of resistor R170 and GND. VR4
4.	Pulse position is symmetry as shown below.

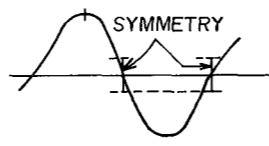

FM4	CENTER VOLTAGE & DISTORTION (MONO)
1.	98MHz, 60dBμ (MONO)
2.	98MHz
3.	Connect the DC voltmeter between front side of resistor R168 and GND, and distortion meter to LINE OUT. T4: Center voltage T3: Distortion factor
4.	CENTER VOLTAGE: DC 0 ± 50mV DISTORTION: within 0.08%

FM11	NOISE DETECTION LEVEL
1.	98MHz, 60dBμ
2.	98MHz
3.	Connect the DC Voltmeter between TR11 collector and GND. VR3
4.	0.1 ± 0.05V

FM1	TUNING VOLTAGE
1.	
2.	Low: 87.5MHz, High: 108.0MHz
3.	Connect the DC digital voltmeter between JW2 and GND. Low: L6, High: VC5 [FRONT END]
4.	Low: 7.0 ± 0.1V, High: 23 ± 0.2V

FM3	SENSITIVITY
1.	Low: 90MHz, High: 106MHz, (MONO) 30~10dBμ
2.	Low: 90MHz, High: 106MHz
3.	Connect the distortion meter to LINE OUT. Low: L1, 2, 4 and 5 [FRONT END] High: VC1, 3 and 4 [FRONT END]
4.	Minimum distortion * For the best result, repeat Low and High adjustments several times.

FM2	OSC BUFFER
1.	
2.	Low: 87.5MHz, High: 108MHz
3.	Connect the oscilloscope between TP1 and GND. Low: L7, High: VC6 [FRONT END]
4.	Level of waveform on the oscilloscope is maximum.

FM8	DISTORTION (STEREO)
1.	98MHz, 60dBμ (STEREO)
2.	98MHz (IF-BAND: WIDE, BLEND & Hi-CUT: "OFF")
3.	Connect the distortion meter to LINE OUT. T1 [FRONT END]
4.	Minimum distortion on both channels. * If the distortion factor is different between L and R channels, readjust VR5 within 1/8 turn, so that the distortion factor between both channels are equal. * Confirm distortion at NARROW mode is less than 0.8%.

FM5	CENTER VOLTAGE OF TUNE INDICATOR
1.	98MHz, 60dBμ (NONO)
2.	98MHz
3.	Connect the DC Voltmeter between both end of resistor R43. T2
4.	DC 0 ± 50mV * Confirm that the TUNE indicator is lit.

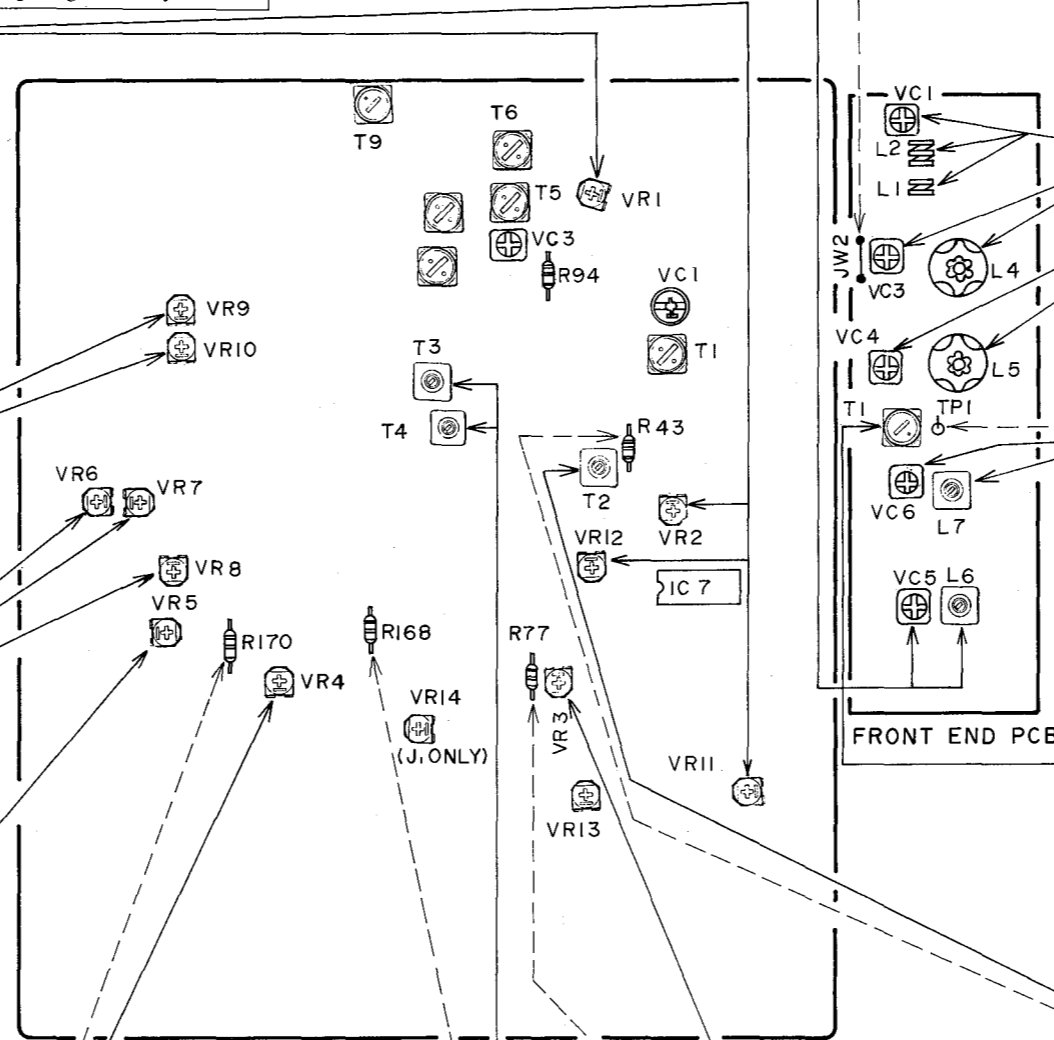

#### 4-2. HOW TO CALL THE PRESET FREQUENCY FOR THE ADJUSTMENT

Press the RESET SW on the REAR PANEL, the tuning frequency preset memory is set as below.

AT-93 **C** **A** **U**

	1	2	3	4	5	6	7	8	9	10
BAND	FM	FM	FM	FM	FM	FM	FM	FM	AM	AM
FREQ	88.00	90.00	98.00	100.00	106.00	108.00	95.70	107.70	530	600
ST/MONO	MONO	MONO	ST	ST	MONO	MONO	FM AUTO	FM AUTO	MONO	MONO
	11	12	13	14	15	16	17	18	19	20
BAND	AM	AM	AM	AM	AM	AM	FM	FM	FM	FM
FREQ	1000	1400	800	1300	1610	1190	92.00	94.00	96.00	102.00
ST/MONO	MONO	MONO	MONO	MONO	MONO	MONO	FM AUTO	FM AUTO	FM AUTO	FM AUTO

AT-93 **E** **V**

	1	2	3	4	5	6	7	8	9	10
BAND	FM	FM	FM	FM	FM	FM	FM	FM	AM	AM
FREQ	88.00	90.00	98.00	100.00	106.00	108.00	95.75	107.75	531	603
ST/MONO	MONO	MONO	ST	ST	MONO	MONO	MONO	ST	MONO	MONO
	11	12	13	14	15	16	17	18	19	20
BAND	AM	AM	AM	AM	AM	AM	FM	FM	FM	FM
FREQ	999	1404	801	1305	1602	1197	87.30	90.60	90.90	96.50
ST/MONO	MONO	MONO	MONO	MONO	MONO	MONO	FM AUTO	FM AUTO	FM AUTO	FM AUTO

AT-93L **E** **B**

	1	2	3	4	5	6	7	8	9	10
BAND	FM	FM	FM	FM	FM	FM	LW	LW	FM	MW
FREQ	88.00	90.00	98.00	100.00	106.00	108.00	160	300	95.75	603
ST/MONO	MONO	MONO	ST	ST	MONO	MONO	MONO	MONO	FM AUTO	MONO
	11	12	13	14	15	16	17	18	19	20
BAND	MW	MW	MW	MW	LW	LW	FM	FM	FM	FM
FREQ	999	1404	801	1305	200	350	92.00	94.00	96.00	102.00
ST/MONO	MONO	MONO	MONO	MONO	MONO	MONO	FM AUTO	FM AUTO	FM AUTO	FM AUTO

#### 4-3. AM SECTION ADJUSTMENT

**NOTE:** 1. Set the S.S.G to 1 kHz, 75 kHz deviation for **A**, **C**, **U** model, 1 kHz 40 kHz deviation for **B**, **E** or **V** model.  
2. Set the MUTE SW to OFF and IF Band SW to WIDE without notice.  
3. Confirm that the Sensitivity margin between Low and High range sensitivities is within 3 dB, otherwise readjust Low and High range sensitivity.

STEP	ADJUSTMENT ITEM
1.	SSG FREQ. & OUTPUT LEVEL
2.	SET Tuning FREQ.
3.	Test Point & ADJ. Part
4.	Result & Remarks

Adjustment Part  
Test Point

**LW2 LW LOW RANG SENSITIVITY**  
1. 160kHz/60dB $\mu$   
2. 160kHz  
3. Connect the distortion meter to LINE OUT. T6  
4. Minimum Distortion.

**LW3 LW HIGH RANG SENSITIVITY**  
1. 300kHz/60dB $\mu$   
2. 300kHz  
3. Connect the distortion meter to LINE OUT. VC4  
4. Minimum Distortion.

**LW1 LW OSC**  
1. —  
2. 351kHz  
3. Connect the DC Voltmeter between R94 (Front side end) and GND. T8  
4. 20V  $\pm$  0.05V

**LW4 SIGNAL INDICATOR LEVEL**  
1. 200kHz/65dB $\mu$   
2. 200kHz  
3. Signal meter on the front panel. VR13  
4. Signal level "10" is light.

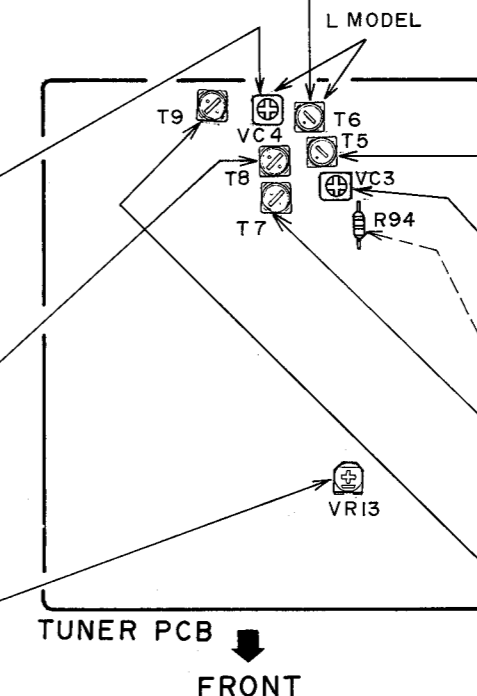

**MW2 MW LOW RANGE SENSITIVITY**  
1. 603kHz (600kHz)/60dB $\mu$   
2. 603kHz (600kHz)  
3. Connect the distortion meter to LINE OUT. T5  
4. Minimum Distortion.

**MW1 MW OSC**  
1. —  
2. 1602kHz  
3. Connect the DC Volt meter between (Front side end) R94 and GND. T7  
4. 20V  $\pm$  0.05V

**MW3 MW HIGH RANGE SENSITIVITY**  
1. 1404kHz (1400kHz)/60dB $\mu$   
2. 1404kHz (1400kHz)  
3. Connect the distortion meter to LINE OUT. VC3  
4. Minimum Distortion.

**MW4 DISTORTION**  
1. 999kHz (1000kHz)/74dB $\mu$   
2. 999kHz (1000kHz)  
3. Connect the distortion meter to LINE OUT. T9  
4. Less than 1.5% distortion factor.



## V. PARTS LIST

### ATTENTION

1. When placing an order for parts, be sure to list Part No., Model No. and the description of each part. Otherwise, the non-delivery of the part or the delivery of a wrong part may result.
2. Please make sure that Part No. is correct when ordering.  
If not, a part different from the one you ordered may be delivered.
3. Since the parts shown in Parts List of Preliminary Service Manual may have been the subject of changes, please use this Parts List for all future reference.

### HOW TO USE THIS PARTS LIST

1. This Parts List lists those parts which are considered necessary for repairs. Other common parts, such as resistors and capacitors, are listed in the "Common List for Service Parts" from which these parts should be selected and stocked.
2. The Recommended Spare Parts List shows those parts in the Parts List which are considered particularly important for service.
3. Parts not shown in the Parts List and "Common List for Service Parts" will not in principle be supplied.
4. How to read the Parts List.

a) Mechanism Block

b) PC Board

#### 2. HEAD BASE BLOCK

REF. NO.	PART NO.	DESCRIPTION
2-1x	BH-T2023A320A	HEAD BASE BLOCK
2-2	HP-H2206A010A	HEAD R/P PR4-8FU C
2-3	ZS-477876	PAN20×03STL CMT
2-4	ZS-536488	BID20×08STL CMT
2-5	ZG-402895	SP CS ANGLE ADJUST

SP (Service Parts) Classification

A small "x" indicates that this part is not shown in the Photo or Illustration.

This number corresponds with the individual parts index number in that figure.

This number corresponds with the Figure Number.

#### 6. MAIN PC BOARD

REF. NO.	PART NO.	DESCRIPTION
6-IC1	EI-324536	IC HD14049BP
6-IC2	EI-336801	IC MB8841-564M
6-C1A	EC-338399	C MMY V 223M 250AC [U,E,B,S]
6-C1B	EC-350949	C MMY V 223M 250DC [J]
6-C1C	EC-338397	C MMY V 223M 125AC [C,A]
6-X1	EI-318384	OSC X'TAL NC-18C

Symbols for primary destination

[A]: AAL(U.S.A.) [S]: SAA(Australia)  
 [B]: BEAB(England) [U]: U/T(Universal Area)  
 [C]: CSA(Canada) [V]: VDE(W. Germany)  
 [E]: CEE(Europe) [Y]: Custom Version  
 [J]: JPN(Japan)

SP (Service Parts) Classification

These reference symbols correspond with component symbols in the Schematic Diagrams.

The available PC Board Blocks are listed separately.

5. When Part No. is known, Parts Index at end of Parts List can be used to locate where that part is shown in Parts List by its Reference No. listed at right of Part No.

### WARNING

△ (\*) INDICATES SAFETY CRITICAL COMPONENTS. FOR CONTINUED SAFETY, REPLACE SAFETY CRITICAL COMPONENTS ONLY WITH MANUFACTURE'S RECOMMENDED PARTS.

### AVERTISSEMENT

△ (\*) IL INDIQUE LES COMPOSANTS CRITIQUES DE SÉCURITÉ. POUR MAINTENIR LE DEGRÉ DE SÉCURITÉ DE L'APPAREIL, NE REMPLACER QUE DES PIÈCES RECOMMANDÉES PAR LE FABRICANT.

## 1. RECOMMENDED SPARE PARTS

We suggest you to stock the following Recommended Spare Part items listed below since they can cover most of the routine service.

Ref. No.	Part No.	Description
1	*BT-367989	TRANS POW A3058-B [B] [T901]
2	*BT-367987	TRANS POW A3058-C [A.C] [T901]
3	*BT-367988	TRANS POW A3058-E [E.V] [T901]
4	*BT-367984	TRANS POW A3058-U [U] [T901]
5	ED-356424	D LED BG5525S GREEN
6	ED-367974	D LED SLV-31PC3 GREEN
7	ED-367973	D LED SPB-15PVW RED, GREEN
8	*ED-357754	D SILICON DS135D 200/1.0A
9	ED-301911	D SILICON H DS448
10	ED-366443	D SILICON H MA700FA5 F10
11	ED-360934	D SILICON H 1SS238
12	ED-348205	D SILICON V MC931 DOUBLE F05
13	*ED-376937	D SILICON 10DF1 FA-2 F12 100/1
14	*ED-372125	D SILICON 11DF1 100/1.0A
15	ED-367971	D VARACTOR KV1320
16	ED-337605	D VARACTOR SVC333(A)
17	ED-346612	D ZENER H HZ11 C1
18	ED-345149	D ZENER H HZ15L 3
19	ED-346594	D ZENER H HZ3 B3
20	ED-343854	D ZENER H HZ30L 2
21	ED-306316	D ZENER H HZ5 C2
22	ED-306010	D ZENER H HZ6 A2
23	ED-309069	D ZENER H HZ6 B2
24	ED-331197	D ZENER H HZ6 C1
25	ED-346535	D ZENER H HZ7L C2
26	ED-328700	D ZENER H HZ9 A2
27	*EF-365409	FUSE BET T 250V 200MA [B]
28	*EF-355374	FUSE BET T 250V 500MA [B]
29	*EF-358974	FUSE BET T 250V 630MA [B]
30	*EF-339905	FUSE SEMKO T 250V 200MA [E.V]
31	*EF-593706	FUSE SEMKO T 250V 500MA [E.V]
32	*EF-601942	FUSE SEMKO T 250V 630MA [E.V]
33	*EF-309388	FUSE TSC A 250V 800MA [U]
34	*EF-310229	FUSE TSC 125V 1.00A [C.A]
35	*EF-305703	FUSE TSC 125V 630MA [C.A]
36	EH-315407	FILTER CE SFE10.7MMKA 10.7MHZ
37	EH-337989	FILTER CE SFE10.7MPKA 10.7MHZ
38	EH-367965	FILTER CE SFE10.7MX2A 10.7MHZ
39	EH-367963	FILTER CE SFE10.7MZ2A 10.7MHZ
40	EH-367966	FILTER CE SFP450G 0.45MHZ
41	EH-368014	FILTER LC LP BL-21RQ
42	EH-368012	FILTER LC LP 25-5690
43	EI-337964	IC BA401
44	EI-373215	IC HD74LS145P
45	EI-322248	IC LA1231N
46	EI-202218	IC LA1245
47	EI-345551	IC LB1403
48	EI-354951	IC LM7000N
49	EI-362587	IC M5238L
50	EI-362588	IC M5238P
51	EI-368015	IC TA7413AP
52	EI-310036	IC TC4066BP
53	EI-306726	IC TC4069UBT
54	EI-367976	IC TC9175N
55	EI-368016	IC UPC1163HA
56	EI-372245	IC.TMP47C400N-6246 A3058
57	EI-367956	OSC CE CSB456F14 0.456MHZ

Ref. No.	Part No.	Description
58	EI-330256	OSC CE F85-006 4MHZ
59	EI-344422	OSC X'TAL HC-18/U 7.200MHZ
60	EJ-359031	TERMINAL LEVER YKD31-0215 P 2P
61	EJ-344423	TERMINAL W/SCREW YKD31-0133P2P
62	EM-367977	IND FL 9-BT-24ZK
63	EO-368018	COIL DET 2 77-5074-04 10.7MHZ
64	EO-368017	COIL IFT A119ACS-18068X10.7MHZ
65	EO-328529	RELAY LEAD LAB2NS 2NO 12V
66	*ER-345751	R FUSE H S10 ERD2FC 1/4W 15ROG
67	*ER-332225	R FUSE H S10 ERD2FC 1/4W 56ROG
68	*ES-361970	SW PUSH SDDLBI 01-1 [POWER SW]
69	ES-344439	SW SLIDE 00420451 2-04-02 [U]
70	ES-349367	SW TACT SKHHAK003A
71	ES-362883	SW TACT SKHLM
72	ET-349449	TR FET 2SK161 O.Y [E.B] [AT-93L]
73	ET-355556	TR FET 2SK241 Y
74	ET-359827	TR FET 2SK246 BL
75	ET-337759	TR FET 2SK246 GR
76	ET-368484	TR FET 2SK373 GR
77	ET-337743	TR FET 3SK107 E.F AKAI
78	ET-368048	TR 2SA1208 S
79	ET-353899	TR 2SA1317 S.T.U [U]
80	ET-368046	TR 2SA1392 S
81	ET-352726	TR 2SA1392 T.U
82	*ET-360687	TR 2SB1015 Y,GR
83	ET-338410	TR 2SC2878 A,B [E.B] [AT-93L]
84	ET-368047	TR 2SC2910 S
85	ET-370038	TR 2SC2910 S.T
86	ET-360067	TR 2SC3330 T,U F05
87	ET-360137	TR 2SC3330 U,V F05
88	ET-349081	TR 2SC3383 S.T
89	ET-357878	TR 2SC3383 S2,T,U
90	ET-356437	TR 2SC930 D2,E,F
91	*ET-349459	TR 2SD1406 O.Y,GR
92	*ET-362113	TR 2SD1406 Y,GR
93	EZ-358816	BATTERY LITHIUM BR2032-1HF

## 2. P.C BOARD BLOCK

Ref. No.	Part No.	Description
1A	BA-A3058A030A	PC TUNER BLK AT-93(U) [U]
1B	BA-A3058A030C	PC TUNER BLK AT-93(C) [C.A]
1C	BA-A3058A030D	PC TUNER BLK AT-93(E) [E]
1D	BA-A3058A030E	PC TUNER BLK AT-93(V) [V]
1E	BA-A3058A030F	PC TUNER BLK AT-93L [E.B]
2	BA-A3058A040A	PC FRONT END BLK AT-93(U)

## 3. TUNER P.C BOARD

Ref. No.	Part No.	Description
BT1	EZ-358816	BATTERY LITHIUM BR2032-1HF
D1	ED-360934	D SILICON H 1SS238
D2	ED-360934	D SILICON H 1SS238
D3	ED-360934	D SILICON H 1SS238
D4	ED-360934	D SILICON H 1SS238
D5	ED-360934	D SILICON H 1SS238

Ref. No.	Part No.	Description	Ref. No.	Part No.	Description
D6	ED-360934	D SILICON H 1SS238	IC2	EI-368016	IC UPC1163HA
D7	ED-360934	D SILICON H 1SS238	IC3	EI-368016	IC UPC1163HA
D8	ED-360934	D SILICON H 1SS238	IC4	EI-322248	IC LA1231N
D9	ED-360934	D SILICON H 1SS238	IC5	EI-337964	IC BA401
D10	ED-360934	D SILICON H 1SS238	IC6	EI-202218	IC LA1245
D11	ED-360934	D SILICON H 1SS238	IC7	EI-354951	IC LM7000N
D12	ED-360934	D SILICON H 1SS238	IC8	EI-368015	IC TA7413AP
D13	ED-360934	D SILICON H 1SS238	IC9	EI-306726	IC TC4069UBT
D14	ED-360934	D SILICON H 1SS238	IC10	EI-310036	IC TC4066BP
D15	ED-301911	D SILICON H DS448	IC11	EI-362588	IC M5238P
D16	ED-360934	D SILICON H 1SS238	IC12	EI-362587	IC M5238L
D17	ED-301911	D SILICON H DS448	IC13	EI-345551	IC LB1403
D18	ED-301911	D SILICON H DS448	IC15	EI-373215	IC HD74LS145P
D19	ED-301911	D SILICON H DS448	IC16	EI-372245	IC.TMP47C400N-6246 A3058
D20	ED-366443	D SILICON H MA700FA5 F10	J3	EJ-376983J	PIN J YKC21-0312 P 2P
D21	ED-366443	D SILICON H MA700FA5 F10	L1	EO-376179	COIL FIX 1 ALF-7.5F F05 101K
D22	ED-301911	D SILICON H DS448	L2	EO-368140	COIL FIX 1 TL-8 123J
D23	ED-301911	D SILICON H DS448	L3	EO-368141	COIL FIX 1 TL-8 103J
D24	ED-301911	D SILICON H DS448	L4	EO-368143	COIL FIX 1 TL-8 473J
D26	ED-348205	D SILICON V MC931 DOUBLE F05	L5	EO-368142	COIL FIX 1 TL-8 153J
D28	ED-337605	D VARACTOR SVC333(A)			[V]
D29	ED-337605	D VARACTOR SVC333(A)	L6	EO-380662J	COIL FIX 1 LF-5.0S F05 2R2M
D30	ED-301911	D SILICON H DS448	RL1	EQ-328529	RELAY LEAD LAB2NS 2NO 12V
		[E,B] [AT-93L]	R1	*ER-356573	R SD ANTI-STATIC 1/2W 225K
D31	ED-301911	D SILICON H DS448	R2	ER-356573	R SD ANTI-STATIC 1/2W 225K
		[E,B] [AT-93L]	R12	ER-368128	R CB H S10 FS RDS 1/4W 560J
D32	ED-301911	D SILICON H DS448	R21	ER-368128	R CB H S10 FS RDS 1/4W 560J
		[E,B] [AT-93L]	R26	ER-372994	R CB H S10 FS RDS 1/4W 470J
D33	ED-348205	D SILICON V MC931 DOUBLE F05	R29	ER-368128	R CB H S10 FS RDS 1/4W 560J
D34	ED-306316	D ZENER H HZ5 C2	R39	ER-368128	R CB H S10 FS RDS 1/4W 560J
D35	ED-301911	D SILICON H DS448	R43	ER-368053	R CB H S10 FS RDS 1/4W 243J
D41	ED-356424	D LED BG5525S GREEN			[U.E.B.V.]
D42	ED-356424	D LED BG5525S GREEN	R43A	ER-368052	R CB H S10 FS RDS 1/4W 183J
D43	ED-301911	D SILICON H DS448			[A.C]
D44	ED-301911	D SILICON H DS448	R44	ER-368128	R CB H S10 FS RDS 1/4W 560J
D45	ED-328700	D ZENER H HZ9 A2	R51	ER-368128	R CB H S10 FS RDS 1/4W 560J
D46	ED-301911	D SILICON H DS448	R55	ER-368128	R CB H S10 FS RDS 1/4W 560J
D47	ED-346612	D ZENER H HZ11 C1	R64	ER-372994	R CB H S10 FS RDS 1/4W 470J
D48	ED-301911	D SILICON H DS448	R65	ER-372994	R CB H S10 FS RDS 1/4W 470J
D49	ED-301911	D SILICON H DS448	R77	ER-368051	R CB H S10 FS RDS 1/4W 153J
D50	ED-346535	D ZENER H HZ7L C2	R186	ER-368127	R CB H S10 FS RDS 1/4W 201J
D51	ED-346535	D ZENER H HZ7L C2	R310	ER-368128	R CB H S10 FS RDS 1/4W 560J
D52	ED-356424	D LED BG5525S GREEN	R365	ER-368128	R CB H S10 FS RDS 1/4W 560J
D53	ED-356424	D LED BG5525S GREEN	SW1	ES-362883	SW TACT SKHLM
D54	ED-356424	D LED BG5525S GREEN	SW2	ES-344439	SW SLIDE 00420451 2-04-02
D55	ED-356424	D LED BG5525S GREEN			[U]
D56	ED-301911	D SILICON H DS448	TM1	EJ-344423	TERMINAL W/SCREW YKD31-0133P2P
D61	ED-306010	D ZENER H HZ6 A2	TM2	EJ-359031	TERMINAL LEVER YKD31-0215 P 2P
D62	ED-301911	D SILICON H DS448	TR1	ET-355556	TR FET 2SK241 Y
D63	ED-301911	D SILICON H DS448	TR2	ET-360067	TR 2SC3330 T,U F05
D64	ED-301911	D SILICON H DS448	TR3	ET-355556	TR FET 2SK241 Y
D65	ED-309069	D ZENER H HZ6 B2	TR4	ET-356437	TR 2SC930 D2,E,F
D66	ED-346594	D ZENER H HZ3 B3	TR5	ET-355556	TR FET 2SK241 Y
D68	ED-301911	D SILICON H DS448	TR6	ET-355556	TR FET 2SK241 Y
D69	ED-301911	D SILICON H DS448	TR7	ET-349449	TR FET 2SK161 O,Y
D71	ED-301911	D SILICON H DS448	TR8	ET-337759	TR FET 2SK246 GR
D72	ED-301911	D SILICON H DS448	TR9	ET-357878	TR 2SC3383 S2,T,U
D73	ED-301911	D SILICON H DS448	TR10	ET-360067	TR 2SC3330 T,U F05
D74	ED-301911	D SILICON H DS448	TR11	ET-360067	TR 2SC3330 T,U F05
D75	ED-301911	D SILICON H DS448	TR12	ET-360067	TR 2SC3330 T,U F05
D76	ED-301911	D SILICON H DS448	TR13	ET-357878	TR 2SC3383 S2,T,U
D77	ED-301911	D SILICON H DS448	TR14	ET-352726	TR 2SA1392 T,U
D78	ED-301911	D SILICON H DS448	TR15	ET-360067	TR 2SC3330 T,U F05
D79	ED-301911	D SILICON H DS448	TR16	ET-357878	TR 2SC3383 S2,T,U
D80	ED-301911	D SILICON H DS448	TR17	ET-352726	TR 2SA1392 T,U
FL1	EH-337989	FILTER CE SFE10.7MPKA 10.7MHZ	TR18	ET-357878	TR 2SC3383 S2,T,U
FL2	EH-367965	FILTER CE SFE10.7MX2A 10.7MHZ	TR19	ET-357878	TR 2SC3383 S2,T,U
FL3	EH-367963	FILTER CE SFE10.7M22A 10.7MHZ	TR20	ET-357878	TR 2SC3383 S2,T,U
FL4	EH-315407	FILTER CE SFE10.7MMKA 10.7MHZ	TR21	ET-357878	TR 2SC3383 S2,T,U
FL5	EH-367966	FILTER CE SFP450G 0.45MHZ	TR22	ET-370038	TR 2SC2910 S,T
FL6	EH-368012	FILTER LC LP 25-5690	TR25	ET-338410	TR 2SC2878 A,B
FL7	EH-368014	FILTER LC LP BL-21RQ			[E,B] [AT-93L]
FL8	EH-368014	FILTER LC LP BL-21RQ	TR26	ET-349449	TR FET 2SK161 O,Y
FR1	*ER-345751	R FUSE H S10 ERD2FC 1/4W 15ROG			[E,B] [AT-93L]
IB1	EH-368055	COMP R RKC10BS 472J	TR27	ET-360067	TR 2SC3330 T,U F05
IB2	EH-368055	COMP R RKC10BS 472J			[E,B] [AT-93L]
IB3	EH-351973	COMP R RKC1/8B4 472J	TR28	ET-360067	TR 2SC3330 T,U F05
IC1	EI-368016	IC UPC1163HA			[E,B] [AT-93L]

Ref. No.	Part No.	Description
TR29	ET-360067	TR 2SC3330 T,U F05 [E,B] [AT-93L]
TR30	ET-349449	TR FET 2SK161 O,Y
TR31	ET-360067	TR 2SC3330 T,U F05
TR32	ET-356437	TR 2SC930 D2,E,F
TR33	ET-368484	TR FET 2SK373 GR
TR34	ET-357878	TR 2SC3383 S2,T,U
TR35	ET-368484	TR FET 2SK373 GR [E,B] [AT-93L]
TR36	ET-357878	TR 2SC3383 S2,T,U [E,B] [AT-93]
TR37	ET-353899	TR 2SA1317 S,T,U
TR38	ET-353899	TR 2SA1317 S,T,U
TR39	ET-353899	TR 2SA1317 S,T,U
TR40	ET-349081	TR 2SC3383 S,T
TR41	ET-368046	TR 2SA1392 S
TR42	ET-368046	TR 2SA1392 S
TR43	ET-349081	TR 2SC3383 S,T
TR44	ET-337759	TR FET 2SK246 GR
TR45	ET-337759	TR FET 2SK246 GR
TR46	ET-337759	TR FET 2SK246 GR
TR47	ET-368047	TR 2SC2910 S
TR48	ET-368048	TR 2SA1208 S
TR49	ET-337759	TR FET 2SK246 GR
TR50	ET-337759	TR FET 2SK246 GR
TR51	ET-360067	TR 2SC3330 T,U F05
TR52	ET-360067	TR 2SC3330 T,U F05
TR53	ET-360067	TR 2SC3330 T,U F05
TR54	ET-353899	TR 2SA1317 S,T,U
TR55	ET-360067	TR 2SC3330 T,U F05
TR56	ET-360067	TR 2SC3330 T,U F05
TR57	ET-360067	TR 2SC3330 T,U F05
TR58	ET-337759	TR FET 2SK246 GR
TR59	ET-337759	TR FET 2SK246 GR
TR60	ET-337759	TR FET 2SK246 GR
TR61	ET-349081	TR 2SC3383 S,T
TR62	ET-368046	TR 2SA1392 S
TR63	ET-368046	TR 2SA1392 S
TR64	ET-349081	TR 2SC3383 S,T
TR65	ET-368046	TR 2SA1392 S
TR66	ET-349081	TR 2SC3383 S,T
TR67	ET-337759	TR FET 2SK246 GR [U]
TR68	ET-337759	TR FET 2SK246 GR
TR69	ET-368047	TR 2SC2910 S
TR70	ET-368048	TR 2SA1208 S
TR71	ET-349081	TR 2SC3383 S,T
TR72	ET-368046	TR 2SA1392 S
TR73	ET-368046	TR 2SA1392 S
TR74	ET-349081	TR 2SC3383 S,T
TR75	ET-368046	TR 2SA1392 S
TR76	ET-349081	TR 2SC3383 S,T
TR77	ET-337759	TR FET 2SK246 GR [U]
TR78	ET-337759	TR FET 2SK246 GR
TR79	ET-368047	TR 2SC2910 S
TR80	ET-368048	TR 2SA1208 S
TR86	ET-360067	TR 2SC3330 T,U F05
TR87	ET-360067	TR 2SC3330 T,U F05
TR88	ET-360067	TR 2SC3330 T,U F05
TR90	ET-360067	TR 2SC3330 T,U F05
TR91	ET-360067	TR 2SC3330 T,U F05
TR92	ET-360067	TR 2SC3330 T,U F05
TR93	ET-360067	TR 2SC3330 T,U F05
TR94	ET-353899	TR 2SA1317 S,T,U
TR95	ET-360067	TR 2SC3330 T,U F05
TR96	ET-360067	TR 2SC3330 T,U F05
TR97	ET-360067	TR 2SC3330 T,U F05
TR98	ET-360067	TR 2SC3330 T,U F05
TR99	ET-360067	TR 2SC3330 T,U F05
TR100	ET-360067	TR 2SC3330 T,U F05
TR101	ET-360067	TR 2SC3330 T,U F05
TR102	ET-360067	TR 2SC3330 T,U F05
TR103	ET-353899	TR 2SA1317 S,T,U [U]
TR104	ET-360067	TR 2SC3330 T,U F05
TR105	ET-360067	TR 2SC3330 T,U F05
T1	EO-368017	COIL IFT A119ACS-18068X10.7MHZ

Ref. No.	Part No.	Description
T2	EO-368018	COIL DET 2 77-5074-04 10.7MHZ
T3	EO-368019	COIL DET 1 77-5060 10.7MHZ
T4	EO-368020	COIL DET 1 77-5061 10.7MHZ
T5	EO-349454	COIL VARI 2 25A-1706-09
T6	EO-349455	COIL VARI 2 25A-2664-16 [E,B] [AT-93L]
T7	EO-348209	COIL OSC 2 7NR-8646Y 115.0 UH [U,A,C,E,V]
T7A	EO-349456	COIL OSC 2 7NRS-9153Z 150.0UH [E,B] [AT-93L]
T8	EO-352089	COIL OSC 2 7BRS-9098X 580.0UH [E,B] [AT-93L]
T9	EO-368022	COIL IFT 125-1143-10 450KHZ
VC1	EV-368058	C S-FIX H VCT51J 15-100
VC3	EC-359065	C S-FIX H CTC-6U-020 4.3-20
VC4	EC-363331	C S-FIX H CTC-6U-030 5.5-30 [E,B] [AT-93L]
VR1	EV-368126	R S-FIX H V6EK-PV3(1S)0.1W 501
VR2	EV-368029	R S-FIX H V6EK-PV3(1S)0.1W 303
VR3	EV-368029	R S-FIX H V6EK-PV3(1S)0.1W 303
VR4	EV-368028	R S-FIX H V6EK-PV3(1S)0.1W 302
VR5	EV-368027	R S-FIX H V6EK-PV3(1S)0.1W 203
VR6	EV-368027	R S-FIX H V6EK-PV3(1S)0.1W 203
VR7	EV-368027	R S-FIX H V6EK-PV3(1S)0.1W 203
VR8	EV-368024	R S-FIX H V6EK-PV3(1S)0.1W 103
VR9	EV-368026	R S-FIX H V6EK-PV3(1S)0.1W 105
VR10	EV-368026	R S-FIX H V6EK-PV3(1S)0.1W 105
VR11	EV-368025	R S-FIX H V6EK-PV3(1S)0.1W 104
VR12	EV-368025	R S-FIX H V6EK-PV3(1S)0.1W 104
VR13	EV-368029	R S-FIX H V6EK-PV3(1S)0.1W 303
X1	EI-344422	OSC X'TAL HC-18 /U 7.200MHZ
X2	EI-367956	OSC CE CSB456F14 0.456MHZ
X3	EI-330256	OSC CE F85-006 4MHZ

#### 4. FRONT END P.C BOARD

Ref. No.	Part No.	Description
D1	ED-367971	D VARACTOR KV1320
D3	ED-367971	D VARACTOR KV1320
D4	ED-367971	D VARACTOR KV1320
D5	ED-367971	D VARACTOR KV1320
D6	ED-367971	D VARACTOR KV1320
L1	EO-349461	COIL FIX 2 LINK
L2	EO-349462	COIL FIX 2 U147
L4	EO-367969	COIL VARI 2 AFE93-RF-1
L5	EO-367970	COIL VARI 2 AFE93-RF-2
L6	EO-367968	COIL VARI 2 AFE93-OSC-U
L7	EO-367968	COIL VARI 2 AFE93-OSC-U
L8	EO-336934	COIL FIX 1 LAL03KH 2R2M
TR1	ET-337743	TR FET 3SK107 E,F AKAI
TR2	ET-337743	TR FET 3SK107 E,F AKAI
TR3	ET-355556	TR FET 2SK241 Y
TR4	ET-355556	TR FET 2SK241 Y
TR5	ET-349449	TR FET 2SK161 O,Y
T1	EO-337640	COIL IFT 119AC-15533X 10.7MHZ
VC1	EC-363329	C S-FIX H CTC-64-010 2.5-10
VC3	EC-363329	C S-FIX H CTC-64-010 2.5-10
VC4	EC-363329	C S-FIX H CTC-64-010 2.5-10
VC5	EC-363329	C S-FIX H CTC-64-010 2.5-10
VC6	EC-363329	C S-FIX H CTC-64-010 2.5-10

#### 5. POWER SUPPLY P.C BOARD

Ref. No.	Part No.	Description
C3	EC-365629	C EC V CUT AS1 102M 35.0DC
C4	EC-365629	C EC V CUT AS1 102M 35.0DC

Ref. No.	Part No.	Description
C13	EC-325109	C EC V CUT AS1 102M 50.0DC [C,A,E,V,B]
C13A	EC-325103	C EC V CUT AS1 331M 50.0DC [U]
C16	EC-316231	C EC V CUT AS1 222M 35.0DC
C18	EC-365619	C EC V CUT AS1 102M 25.0DC
D1	*ED-376937	D SILICON 10DF1 FA-2 F12 100/1
D2	*ED-376937	D SILICON 10DF1 FA-2 F12 100/1
D3	*ED-376937	D SILICON 10DF1 FA-2 F12 100/1
D4	*ED-376937	D SILICON 10DF1 FA-2 F12 100/1
D5	ED-345149	D ZENER H HZ15L 3
D6	ED-345149	D ZENER H HZ15L 3
D7	*ED-372125	D SILICON 11DF1 100/1.0A
D8	*ED-372125	D SILICON 11DF1 100/1.0A
D9	*ED-357754	D SILICON DS135D 200/1.0A
D10	*ED-357754	D SILICON DS135D 200/1.0A
D11	*ED-357754	D SILICON DS135D 200/1.0A
D12	*ED-357754	D SILICON DS135D 200/1.0A
D13	*ED-357754	D SILICON DS135D 200/1.0A
D14	*ED-357754	D SILICON DS135D 200/1.0A
D15	ED-343854	D ZENER H HZ30L 2
D16	ED-331197	D ZENER H HZ6 C1
FR1	*ER-332225	R FUSE H S10 ERD2FC 1/4W 56ROG
R1	ER-368124	R CB H S12 FS RDS 1/2W 331J
R2	ER-368124	R CB H S12 FS RDS 1/2W 331J
R10	ER-368125	R CB H S12 FS RDS 1/2W 222J
R13	ER-375106	R CB H S10 FS RDS 1/4W 221J
R14	ER-375106	R CB H S10 FS RDS 1/4W 221J
R17	ER-363986	R OMF H S15 FS 2W 101J
R18	ER-363986	R OMF H S15 FS 2W 101J
R19	ER-372991	R CB H S10 FS RDS 1/4W 101J
R21	*ER-356573	R SD ANTI-STATIC 1/2W 225K
TR1	*ET-362113	TR 2SD1406 Y,GR
TR2	*ET-360687	TR 2SB1015 Y,GR
TR3	ET-359827	TR FET 2SK246 BL
TR4	ET-359827	TR FET 2SK246 BL
TR7	*ET-349459	TR 2SD1406 O,Y,GR
TR8	ET-359827	TR FET 2SK246 BL
TR9	*ET-349459	TR 2SD1406 O,Y,GR
TR10	*ET-349459	TR 2SD1406 O,Y,GR
TR11	*ET-349459	TR 2SD1406 O,Y,GR
TR12	ET-360137	TR 2SC3330 U,V F05
F7	*EF-309388	FUSE TSC A 250V 800MA [U]
F3	*EF-310229	FUSE TSC 125V 1.00A [C,A]
F4	*EF-310229	FUSE TSC 125V 1.00A [C,A]
F5	*EF-305703	FUSE TSC 125V 630MA [C,A]
F6	*EF-305703	FUSE TSC 125V 630MA [C,A]
F1	*EF-339905	FUSE SEMKO T 250V 200MA [E,V]
F2	*EF-339905	FUSE SEMKO T 250V 200MA [E,V]
F3	*EF-601942	FUSE SEMKO T 250V 630MA [E,V]
F4	*EF-601942	FUSE SEMKO T 250V 630MA [E,V]
F5	*EF-593706	FUSE SEMKO T 250V 500MA [E,V]
F6	*EF-593706	FUSE SEMKO T 250V 500MA [E,V]
F1	*EF-365409	FUSE BET T 250V 200MA [B]
F2	*EF-365409	FUSE BET T 250V 200MA [B]
F3	*EF-358974	FUSE BET T 250V 630MA [B]
F4	*EF-358974	FUSE BET T 250V 630MA [B]
F5	*EF-355374	FUSE BET T 250V 500MA [B]
F6	*EF-355374	FUSE BET T 250V 500MA [B]

## 6. POWER SW P.C BOARD

Ref. No.	Part No.	Description
C31	*EC-320548	C CE V F 103Z 250AC [U]
C31A	*EC-338496	C CE V FZ 472P 400AC [C,A,E,V,B]
SW1	*ES-361970	SW PUSH SDDL1B1 01-1 [POWER SW]

## 7. FLD P.C BOARD

Ref. No.	Part No.	Description
D1	ED-367973	D LED SPB-15PVW RED, GREEN
D2	ED-367973	D LED SPB-15PVW RED, GREEN
D3	ED-367973	D LED SPB-15PVW RED, GREEN
D4	ED-367973	D LED SPB-15PVW RED, GREEN
D5	ED-367973	D LED SPB-15PVW RED, GREEN
D6	ED-367973	D LED SPB-15PVW RED, GREEN
D7	ED-367973	D LED SPB-15PVW RED, GREEN
D8	ED-367973	D LED SPB-15PVW RED, GREEN
D9	ED-367973	D LED SPB-15PVW RED, GREEN
D10	ED-367973	D LED SPB-15PVW RED, GREEN
D11	ED-367974	D LED SLV-31PC3 GREEN
D12	ED-367974	D LED SLV-31PC3 GREEN
D13	ED-367974	D LED SLV-31PC3 GREEN
D14	ED-367974	D LED SLV-31PC3 GREEN
D15	ED-367974	D LED SLV-31PC3 GREEN
D16	ED-367974	D LED SLV-31PC3 GREEN
D17	ED-367974	D LED SLV-31PC3 GREEN
D18	ED-367974	D LED SLV-31PC3 GREEN
D19	ED-367974	D LED SLV-31PC3 GREEN
D20	ED-367974	D LED SLV-31PC3 GREEN
D21	ED-367974	D LED SLV-31PC3 GREEN
D22	ED-367974	D LED SLV-31PC3 GREEN
D23	ED-367974	D LED SLV-31PC3 GREEN
IC1	EI-367976	IC TC9175N
IN1	EM-367977	IND FL 9-BT-24ZK
SW1	ES-349367	SW TACT SKHHAK003A
SW2	ES-349367	SW TACT SKHHAK003A
SW3	ES-349367	SW TACT SKHHAK003A
SW4	ES-349367	SW TACT SKHHAK003A
SW5	ES-349367	SW TACT SKHHAK003A
SW6	ES-349367	SW TACT SKHHAK003A
SW7	ES-349367	SW TACT SKHHAK003A
SW8	ES-349367	SW TACT SKHHAK003A
SW9	ES-349367	SW TACT SKHHAK003A
SW10	ES-349367	SW TACT SKHHAK003A
SW11	ES-349367	SW TACT SKHHAK003A
SW12	ES-349367	SW TACT SKHHAK003A

## 8. CONTROL P.C BOARD

Ref. No.	Part No.	Description
D1	ED-301911	D SILICON H DS448
D2	ED-301911	D SILICON H DS448
D3	ED-301911	D SILICON H DS448
D4	ED-301911	D SILICON H DS448
D5	ED-301911	D SILICON H DS448
D6	ED-301911	D SILICON H DS448
SW1	ES-349367	SW TACT SKHHAK003A
SW2	ES-349367	SW TACT SKHHAK003A
SW3	ES-349367	SW TACT SKHHAK003A
SW4	ES-349367	SW TACT SKHHAK003A
SW5	ES-349367	SW TACT SKHHAK003A
SW6	ES-349367	SW TACT SKHHAK003A
SW7	ES-349367	SW TACT SKHHAK003A
SW8	ES-349367	SW TACT SKHHAK003A
SW9	ES-349367	SW TACT SKHHAK003A
SW10	ES-349367	SW TACT SKHHAK003A

**FINAL ASSEMBLY BLOCK**

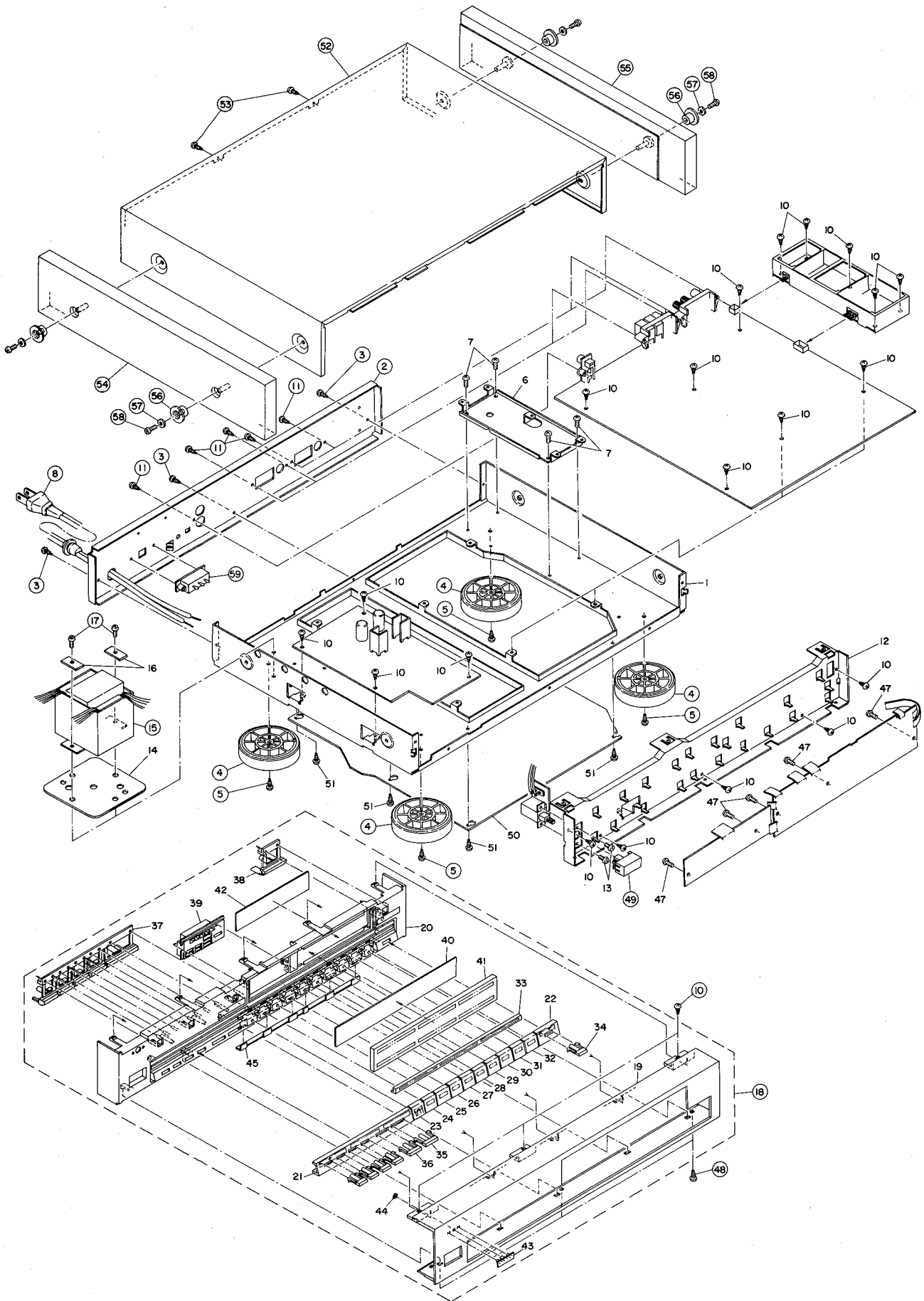

**PARTS LIST**

## 9. FINAL ASSEMBLY BLOCK

Ref. No.	Part No.	Description
2A	SP-368662B	PANEL REAR AT-93(U) [U]
2B	SP-368662C	PANEL REAR AT-93(A,C) [C,A]
2C	SP-368662D	PANEL REAR AT-93(E,V) [E,V]
2D	SP-368662F	PANEL REAR AT-93L(E) [E]
2E	SP-368662E	PANEL REAR AT-93L(B) [B]
3	ZS-308846	T2BR30X08STL BZN PROJECTION
4	SA-B368687	FOOT ROUND SHAPED PART
5	ZS-609017	T2BR40X12STL CMT
8A	*EW-363656	AC CORD200 0129AVFF B200 A U/T [U]
8B	*EW-363811	AC CORD200 KP10WSPT2 B200 A UC [C,A]
8C	*EW-363669	AC CORD200 0364 LCFL B200 A EV [E,V]
8D	*EW-363681	AC CORD200 LCFL B200 A B [B]
10	ZS-447840	T2BR30X08STL CMT
11	ZS-308846	T2BR30X08STL BZN PROJECTION
15A	*BT-367984	TRANS POW A3058-U [U] [T901]
15B	*BT-367987	TRANS POW A3058-C [A,C] [T901]
15C	*BT-367988	TRANS POW A3058-E [E,V] [T901]
15D	*BT-367989	TRANS POW A3058-B [B] [T901]
17	ZS-346742	ST BID40X08STL CMT CUP
18A	BD-A3058A020A	PANEL FRONT BLK AT-93-B(U)
18B	BD-A3058A020C	PANEL FRONT BLK AT-93L-B
48	ZS-463353	T2BR30X08STL BNI
49	SK-373236B	KNOB POWER-B
52	SP-368689B	COVER UPPER-B
53	ZS-308846	T2BR30X08STL BZN PROJECTION
54	SP-368691	SIDE BOARD(L)
55	SP-368692	SIDE BOARD(R)
56	ZW-376292	WASHER SIDE BOARD
57	ZW-380300J	WAVE W 43X080X015 SUS
58	ZS-376293	SCREW SIDE BOARD
59	*ES-348463	SW SLIDE 00120297 01-2 [U] [SW901][VOTAGE SELECTOR]

## 10. ACCESSORY

Ref. No.	Part No.	Description
1	AX-356999	CORD OFC NI-P P-P 2P 2PCS
2	EJ-352118	SOCKET COAX PAL B2-714P-900
3	EE-315329	ANT DIPOLE SAE-010
4	EE-349443	ANT LOOP LA-300
5	AX-349444	ANT CATCH SET AH-003

# INDEX

Part No.	Ref. No.	Part No.	Ref. No.	Part No.	Ref. No.	Part No.	Ref. No.
AX-349444	5	ED-331197	24	ED-367974	D20	EI-367956	57
AX-356999	1	ED-331197	D16	ED-367974	D21	EI-367956	X2
BA-A3058A030A	1A	ED-337605	16	ED-367974	D22	EI-367976	54
BA-A3058A030C	1B	ED-337605	D28	ED-367974	D23	EI-367976	IC1
BA-A3058A030D	1C	ED-337605	D29	ED-372125	14	EI-368015	51
BA-A3058A030E	1D	ED-343854	20	ED-372125	D7	EI-368015	IC8
BA-A3058A030F	1E	ED-343854	D15	ED-372125	D8	EI-368016	55
BA-A3058A040A	2	ED-345149	18	ED-376937	13	EI-368016	IC1
BD-A3058A020A	18A	ED-345149	D5	ED-376937	D1	EI-368016	IC2
BD-A3058A020C	18B	ED-345149	D6	ED-376937	D2	EI-368016	IC3
BT-367984	4	ED-346535	25	ED-376937	D3	EI-372245	56
BT-367984	15A	ED-346535	D50	ED-376937	D4	EI-372245	IC16
BT-367987	2	ED-346535	D51	EE-315329	3	EI-373215	44
BT-367987	15B	ED-346594	19	EE-349443	4	EI-373215	IC15
BT-367988	3	ED-346594	D66	EF-305703	35	EJ-344423	61
BT-367988	15C	ED-346612	17	EF-305703	F5	EJ-344423	TM1
BT-367989	1	ED-346612	D47	EF-305703	F6	EJ-352118	2
BT-367989	15D	ED-348205	12	EF-309388	33	EJ-359031	60
EC-316231	C16	ED-348205	D26	EF-309388	F7	EJ-359031	TM2
EC-320548	C31	ED-348205	D33	EF-310229	34	EJ-376983J	J3
EC-325103	C13A	ED-356424	5	EF-310229	F3	EM-367977	62
EC-325109	C13	ED-356424	D41	EF-310229	F4	EM-367977	IN1
EC-338496	C31A	ED-356424	D42	EF-339905	30	EO-336934	L8
EC-359065	VC3	ED-356424	D52	EF-339905	F1	EO-337640	T1
EC-363329	VC1	ED-356424	D53	EF-339905	F2	EO-348209	T7
EC-363329	VC3	ED-356424	D54	EF-355374	28	EO-349454	T5
EC-363329	VC4	ED-356424	D55	EF-355374	F5	EO-349455	T6
EC-363329	VC5	ED-357754	8	EF-355374	F6	EO-349456	T7A
EC-363329	VC6	ED-357754	D9	EF-358974	29	EO-349461	L1
EC-363331	VC4	ED-357754	D10	EF-358974	F3	EO-349462	L2
EC-365619	C18	ED-357754	D11	EF-358974	F4	EO-352089	T8
EC-365629	C3	ED-357754	D12	EF-365409	27	EO-367968	L6
EC-365629	C4	ED-357754	D13	EF-365409	F1	EO-367968	L7
ED-301911	9	ED-357754	D14	EF-365409	F2	EO-367969	L4
ED-301911	D15	ED-360934	11	EF-593706	31	EO-367970	L5
ED-301911	D17	ED-360934	D1	EF-593706	F5	EO-368017	64
ED-301911	D18	ED-360934	D2	EF-593706	F6	EO-368017	T1
ED-301911	D19	ED-360934	D3	EF-601942	32	EO-368018	63
ED-301911	D22	ED-360934	D4	EF-601942	F3	EO-368018	T2
ED-301911	D23	ED-360934	D5	EF-601942	F4	EO-368019	T3
ED-301911	D24	ED-360934	D6	EH-315407	36	EO-368020	T4
ED-301911	D30	ED-360934	D7	EH-315407	FL4	EO-368022	T9
ED-301911	D31	ED-360934	D8	EH-337989	37	EO-368140	L2
ED-301911	D32	ED-360934	D9	EH-337989	FL1	EO-368141	L3
ED-301911	D35	ED-360934	D10	EH-351973	IB3	EO-368142	L5
ED-301911	D43	ED-360934	D11	EH-367963	39	EO-368143	L4
ED-301911	D44	ED-360934	D12	EH-367963	FL3	EO-376179	L1
ED-301911	D46	ED-360934	D13	EH-367965	38	EO-380662J	L6
ED-301911	D48	ED-360934	D14	EH-367965	FL2	EQ-328529	65
ED-301911	D49	ED-360934	D16	EH-367966	40	EQ-328529	RL1
ED-301911	D56	ED-366443	10	EH-367966	FL5	ER-332225	67
ED-301911	D62	ED-366443	D20	EH-368012	42	ER-332225	FR1
ED-301911	D63	ED-366443	D21	EH-368012	FL6	ER-345751	66
ED-301911	D64	ED-367971	15	EH-368014	41	ER-345751	FR1
ED-301911	D68	ED-367971	D1	EH-368014	FL7	ER-356573	R1
ED-301911	D69	ED-367971	D3	EH-368014	FL8	ER-356573	R2
ED-301911	D71	ED-367971	D4	EH-368055	IB1	ER-356573	R21
ED-301911	D72	ED-367971	D5	EH-368055	IB2	ER-363986	R17
ED-301911	D73	ED-367971	D6	EI-202218	46	ER-363986	R18
ED-301911	D74	ED-367973	7	EI-202218	IC6	ER-368051	R77
ED-301911	D75	ED-367973	D1	EI-306726	53	ER-368052	R43A
ED-301911	D76	ED-367973	D2	EI-306726	IC9	ER-368053	R43
ED-301911	D77	ED-367973	D3	EI-310036	52	ER-368124	R1
ED-301911	D78	ED-367973	D4	EI-310036	IC10	ER-368124	R2
ED-301911	D79	ED-367973	D5	EI-322248	45	ER-368125	R10
ED-301911	D80	ED-367973	D6	EI-322248	IC4	ER-368127	R186
ED-301911	D1	ED-367973	D7	EI-330256	58	ER-368128	R12
ED-301911	D2	ED-367973	D8	EI-330256	X3	ER-368128	R21
ED-301911	D3	ED-367973	D9	EI-337964	43	ER-368128	R29
ED-301911	D4	ED-367973	D10	EI-337964	IC5	ER-368128	R39
ED-301911	D5	ED-367974	6	EI-344422	59	ER-368128	R44
ED-301911	D6	ED-367974	D11	EI-344422	X1	ER-368128	R51
ED-306010	22	ED-367974	D12	EI-345551	47	ER-368128	R55
ED-306010	D61	ED-367974	D13	EI-345551	IC13	ER-368128	R310
ED-306316	21	ED-367974	D14	EI-354951	48	ER-368128	R365
ED-306316	D34	ED-367974	D15	EI-354951	IC7	ER-372991	R19
ED-309069	23	ED-367974	D16	EI-362587	49	ER-372994	R26
ED-309069	D65	ED-367974	D17	EI-362587	IC12	ER-372994	R64
ED-328700	26	ED-367974	D18	EI-362588	50	ER-372994	R65
ED-328700	D45	ED-367974	D19	EI-362588	IC11	ER-375106	R13



Part No.	Ref. No.	Part No.	Ref. No.	Part No.	Ref. No.	Part No.	Ref. No.
ER-375106	R14	ET-355556	TR1	ET-368484	TR33		
ES-344439	69	ET-355556	TR3	ET-368484	TR35		
ES-344439	SW2	ET-355556	TR5	ET-370038	85		
ES-348463	59	ET-355556	TR6	ET-370038	TR22		
ES-349367	70	ET-355556	TR3	EV-368024	VR8		
ES-349367	SW1	ET-355556	TR4	EV-368025	VR11		
ES-349367	SW2	ET-356437	90	EV-368025	VR12		
ES-349367	SW3	ET-356437	TR4	EV-368026	VR9		
ES-349367	SW4	ET-356437	TR32	EV-368026	VR10		
ES-349367	SW5	ET-357878	89	EV-368027	VR5		
ES-349367	SW6	ET-357878	TR9	EV-368027	VR6		
ES-349367	SW7	ET-357878	TR13	EV-368027	VR7		
ES-349367	SW8	ET-357878	TR16	EV-368028	VR4		
ES-349367	SW9	ET-357878	TR18	EV-368029	VR2		
ES-349367	SW10	ET-357878	TR19	EV-368029	VR3		
ES-349367	SW11	ET-357878	TR20	EV-368029	VR13		
ES-349367	SW12	ET-357878	TR21	EV-368058	VC1		
ES-349367	SW1	ET-357878	TR34	EV-368126	VR1		
ES-349367	SW2	ET-357878	TR36	EW-363656	8A		
ES-349367	SW3	ET-359827	74	EW-363669	8C		
ES-349367	SW4	ET-359827	TR3	EW-363681	8D		
ES-349367	SW5	ET-359827	TR4	EW-363811	8B		
ES-349367	SW6	ET-359827	TR8	EZ-358816	93		
ES-349367	SW7	ET-360067	86	EZ-358816	BT1		
ES-349367	SW8	ET-360067	TR2	SA-B368687	4		
ES-349367	SW9	ET-360067	TR10	SK-373236B	49		
ES-349367	SW10	ET-360067	TR11	SP-368662B	2A		
ES-361970	68	ET-360067	TR12	SP-368662C	2B		
ES-361970	SW1	ET-360067	TR15	SP-368662D	2C		
ES-362883	71	ET-360067	TR27	SP-368662E	2E		
ES-362883	SW1	ET-360067	TR28	SP-368662F	2D		
ET-337743	77	ET-360067	TR29	SP-368689B	52		
ET-337743	TR1	ET-360067	TR31	SP-368691	54		
ET-337743	TR2	ET-360067	TR51	SP-368692	55		
ET-337759	75	ET-360067	TR52	ZS-308846	3		
ET-337759	TR8	ET-360067	TR53	ZS-308846	11		
ET-337759	TR44	ET-360067	TR55	ZS-308846	53		
ET-337759	TR45	ET-360067	TR56	ZS-346742	17		
ET-337759	TR46	ET-360067	TR57	ZS-376293	58		
ET-337759	TR49	ET-360067	TR86	ZS-447840	10		
ET-337759	TR50	ET-360067	TR87	ZS-463353	48		
ET-337759	TR58	ET-360067	TR88	ZS-609017	5		
ET-337759	TR59	ET-360067	TR90	ZW-376292	56		
ET-337759	TR60	ET-360067	TR91	ZW-380300J	57		
ET-337759	TR67	ET-360067	TR92				
ET-337759	TR68	ET-360067	TR93				
ET-337759	TR77	ET-360067	TR95				
ET-337759	TR78	ET-360067	TR96				
ET-338410	83	ET-360067	TR97				
ET-338410	TR25	ET-360067	TR98				
ET-349081	88	ET-360067	TR99				
ET-349081	TR40	ET-360067	TR100				
ET-349081	TR43	ET-360067	TR101				
ET-349081	TR61	ET-360067	TR102				
ET-349081	TR64	ET-360067	TR104				
ET-349081	TR66	ET-360067	TR105				
ET-349081	TR71	ET-360137	87				
ET-349081	TR74	ET-360137	TR12				
ET-349081	TR76	ET-360687	82				
ET-349449	72	ET-360687	TR2				
ET-349449	TR7	ET-362113	92				
ET-349449	TR26	ET-362113	TR1				
ET-349449	TR30	ET-368046	80				
ET-349449	TR5	ET-368046	TR41				
ET-349459	91	ET-368046	TR42				
ET-349459	TR7	ET-368046	TR62				
ET-349459	TR9	ET-368046	TR63				
ET-349459	TR10	ET-368046	TR65				
ET-349459	TR11	ET-368046	TR72				
ET-352726	81	ET-368046	TR73				
ET-352726	TR14	ET-368046	TR75				
ET-352726	TR17	ET-368047	84				
ET-353899	79	ET-368047	TR47				
ET-353899	TR37	ET-368047	TR69				
ET-353899	TR38	ET-368047	TR79				
ET-353899	TR39	ET-368048	78				
ET-353899	TR54	ET-368048	TR48				
ET-353899	TR94	ET-368048	TR70				
ET-353899	TR103	ET-368048	TR80				
ET-355556	73	ET-368484	76				

MEMO

---

## ABBREVIATIONS (TUNER)

ABBREVIATION	EXPLANATION	ABBREVIATION	EXPLANATION
AFC	Auto Frequency Control	MEMO	MEMOry
AGC	Auto Gain Control	MI-COM	Micro-COMputer
ALC	Auto Level Control	MIN	MINimum
AM	Amplitude Modulation	MIX	MIXing
AMP	AMPlifier	MPX	Multi pleX
ANT	ANTenna	MW	Medium Wave (frequency)
BATT	BATTery	NC	No Connection
BLK	BLocK	NFB	Negative Feed Back
BUFF	BUFFer	OSC	OSCillator
COMP	COMPalator	PCB	Printed Circuit Board
DET	DETECT (DEtector)	PLL	Phase Locked Loop
FLD		Q.D	Quadrature Detector
FM	Frequency Modulation	Rch	Right channel
FREQ	FREQuency	REF	REFerence
GND	GrouND	REG	REGulator
H	High	RF	Radio Frequency
HPF	High Pass Filter	SEG	SEGment
IF	Intermediate Frequency	SELE	SELEctor
IHF	Institut of High Fidelity	SENS	SENSitivity
IND	INDicator	SIG	SIGNal
I/O	In/Out	S/N	Signal to Noise Ratio
JW	Jumper Wire	SSG	Standard Signal Generator
L	Low	STD	STanDard
LCD	Liquid Crystal Display	SW	SWitch: Short Wave (frequency)
Lch	Left channel	THD	Total Harmonic Distortion
LED	Light Emitting Diode	TP	Test Point
LPF	Low Pass Filter	VCO	Voltage Controlled Oscillator
LW	Long Wave (Frequency)	VR	Variable Resistor
		X'TAL	Crystal

# AKAI

## MODEL AT-93/L

### SCHEMATIC DIAGRAM AND PC BOARDS

74069UB (HEX INVERTER)

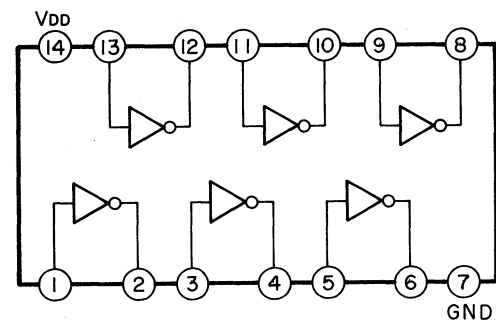

TC4066BP (QUAD BILATERAL SWITCH)

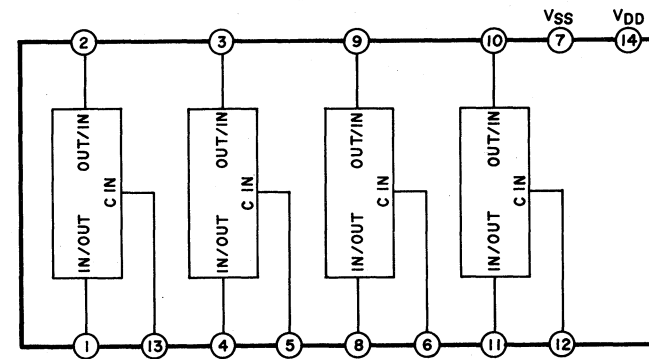

C IN	IMPEDANCE BETWEEN IN/OUT - OUT/IN
H	0.5 to $5 \times 10^2$ OHMS
L	MORE THAN $10^9$ OHMS

7413AP (PLL FM STEREO MULTIPLEXER)

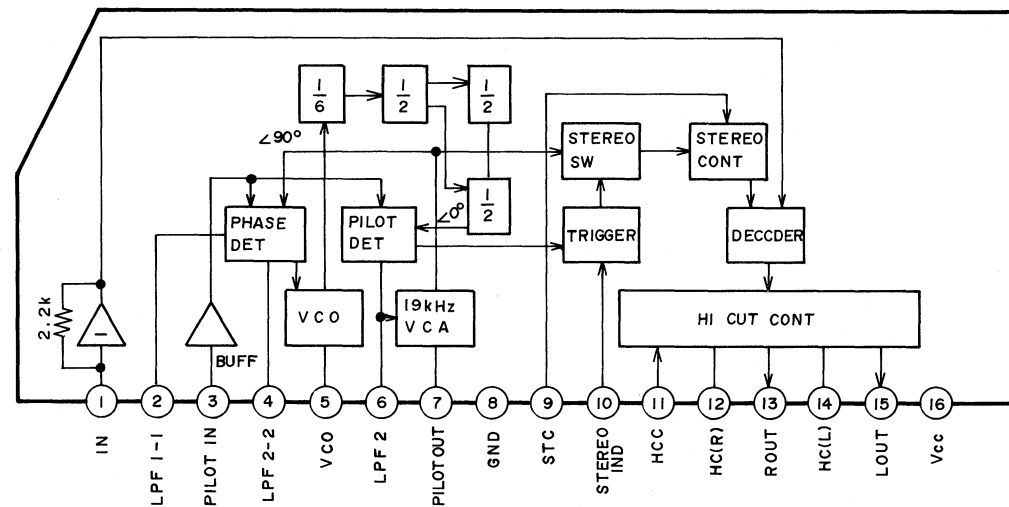

TMP47C400N-6246 A3058

Pin No.	Name	I/O	Active	Description
1	SEP 1	O	L	Output of blend for <SEP 1 >
2	SEP 2	O	L	Output of blend for <SEP 2 >
3	MONO	O	L	Output of blend for <MONO >
4	NARROW/WIDE	O	L	FM-Band Switch Control. (H: NARROW, L: WIDE)
5	HICUT	O	H	FM-HI-CUT Control. (H: ON, L: OFF)
6	MUTE	O	L	MUTE Control. (L: MUTE)
7	ANT. A/B	O	L	FM ANT. A and B Switch Control. (L: ANT. A, H: ANT. B)
8	STRQ	O	L	REC CAL. TONE OSC Control. (H: CAL TONE OSC "ON")
9	DATA	O	L	Serial Data Out Put for PLL and FLD Drive.
10	CK	O	L	
11	WR	O	L	
12	CE	O	L	
13	A	O	H	PRESET CH. Indicator (LED) ON/OFF Control A
14	B	O	H	PRESET CH. Indicator (LED) ON/OFF Control B
15	C	O	H	PRESET CH. Indicator (LED) ON/OFF Control C
16	D	O	H	PRESET CH. Indicator (LED) ON/OFF Control D
17	10/20	O	L	PRESET CH. Select Control (L: CH1 to 10, H: CH10 to 20)
18	BAND	O	H	Input of Destination Select.
19	DIGIT 5	O	L	KEY STROBE 5 Output
20	DIGIT 4	O	L	KEY STROBE 4 Output
21	Vss			GND
22	DIGIT 3	O	L	KEY STROBE 3 Output
23	DIGIT 2	O	L	KEY STROBE 2 Output
24	DIGIT 1	O	L	KEY STROBE 1 Output
25	DIGIT 0	O	L	KEY STROBE 0 Output
26	KEY 0	I		KEY RETURN Input
27	KEY 1	I		KEY RETURN input
28	KEY 2	I		KEY RETURN Input
29	KEY 3	I		KEY RETURN Input
30	TEST			GND
31	X IN	I		
32	X OUT	O		
33	RST	I	L	Reset
34	HOLD	I	L	VDD ON/OFF Detection Input, for Back Up mode Control
35	ST OUT	I	L	Auto Scan Stop Control, When Station is Received.
36	NOISE	I	L	Noise Condition Input. (When received Noise: L)
37	STEREO			Stereo Mode Input. (When stereo mode: L)
38	TUNED			Tuned Mode Input. (When tuned mode: L)
39	S1			Signal Level Data Input

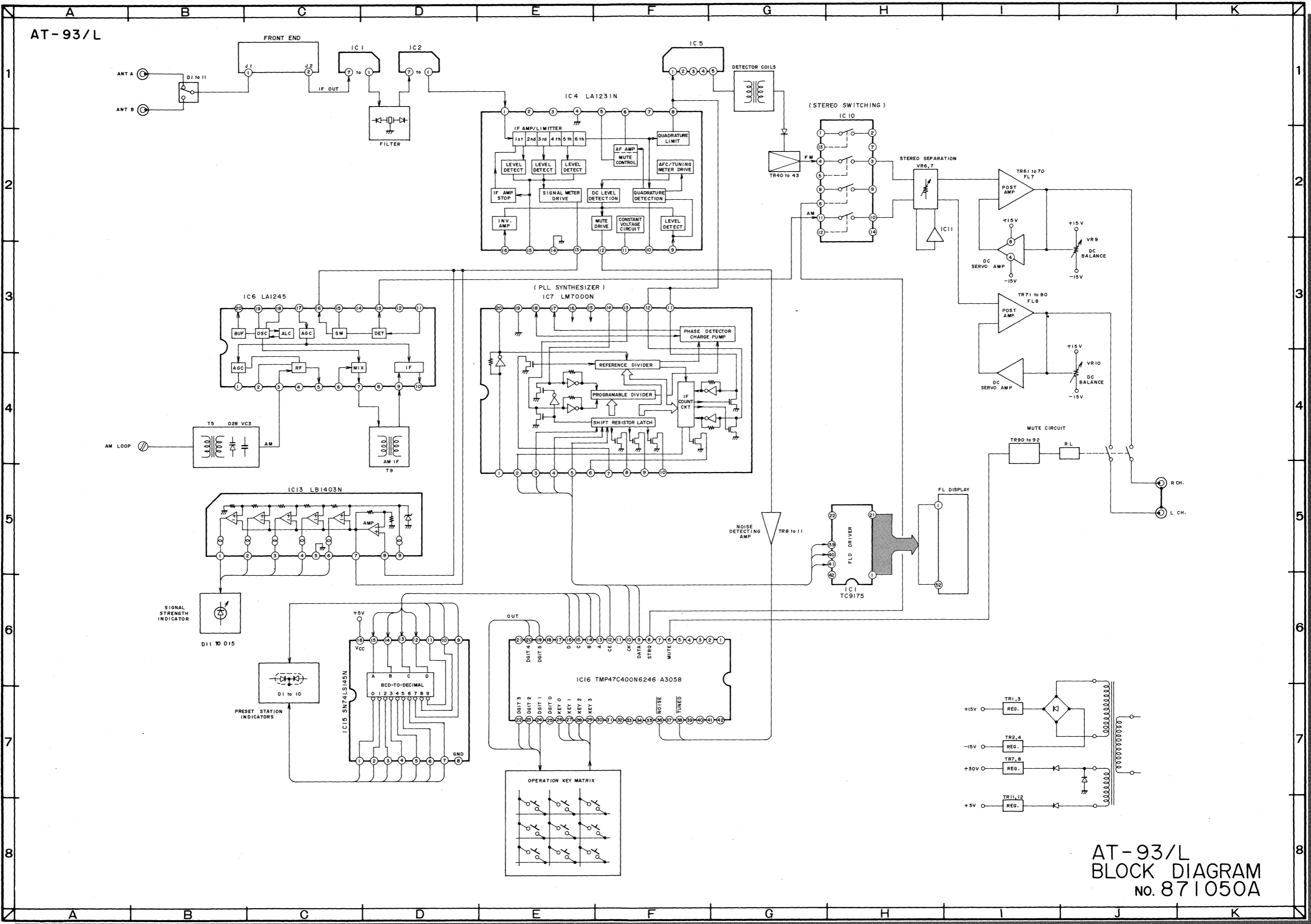

AT-93/L  
BLOCK DIAGRAM  
no. 871050A

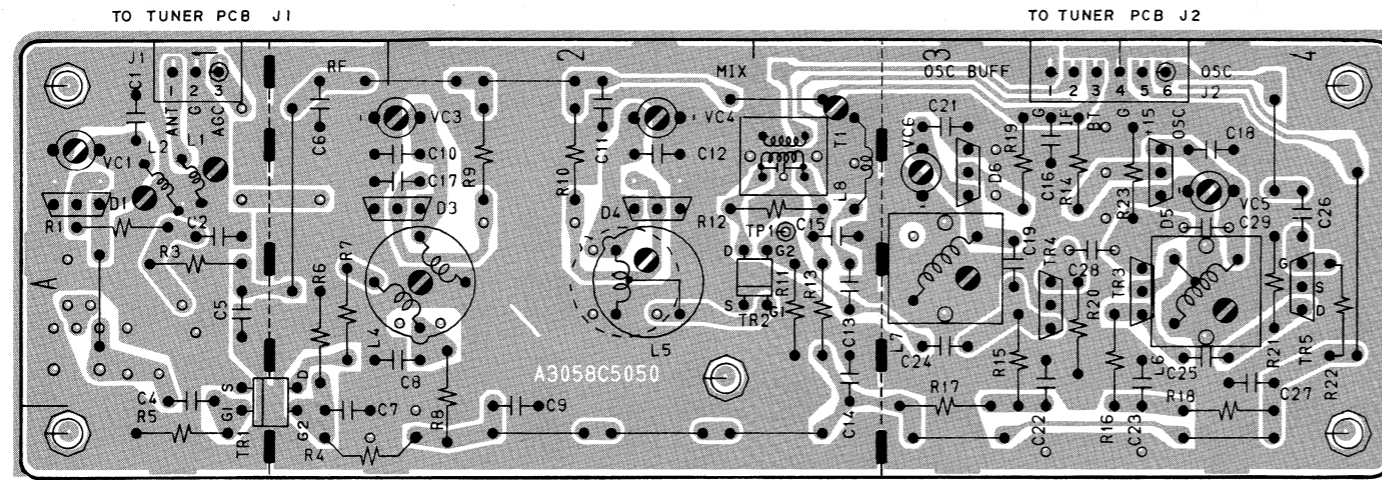

FRONT END PCB A3058C5050

- L1, 2, 4, 5 --- FM SENS (LOW)
- VC1, 3, 4 --- FM SENS (HIGH)
- L7 --- FM OSC BUFFER (LOW)
- VC6 --- FM OSC BUFFER (HIGH)
- L6 --- FM OSC (LOW)
- VC5 --- FM OSC (HIGH)

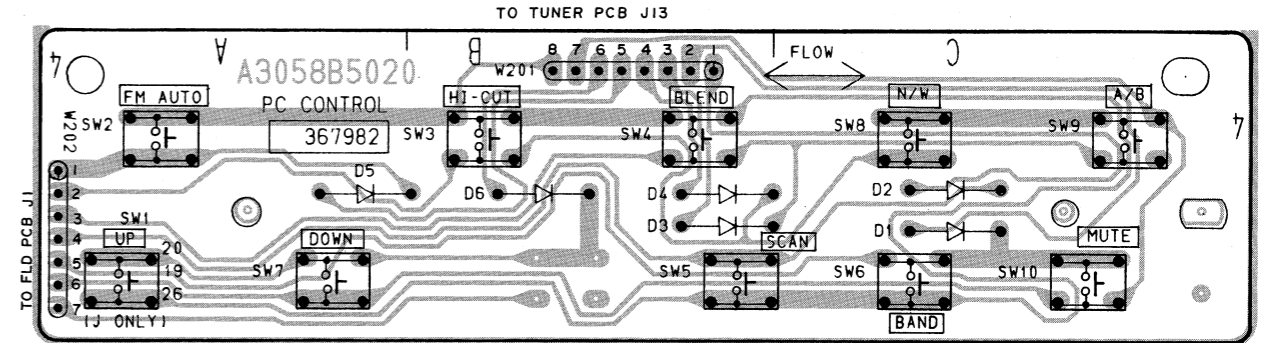
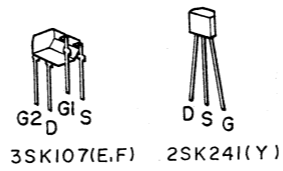
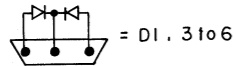

CONTROL PCB A3058B5020

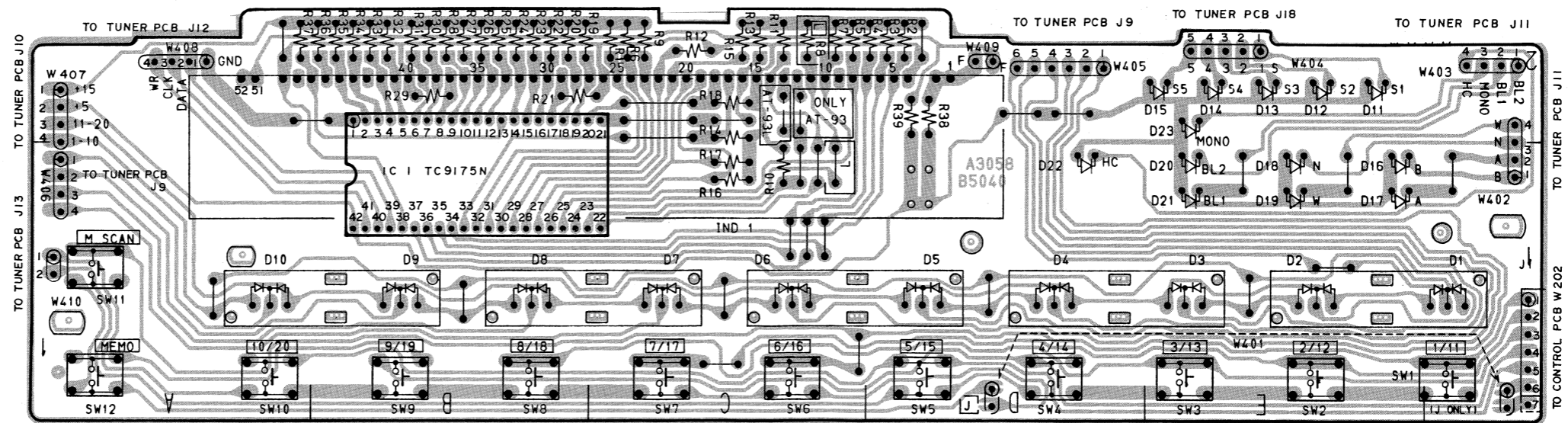

FLD PCB A3058B5040

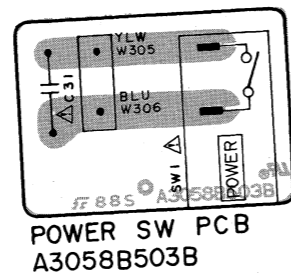
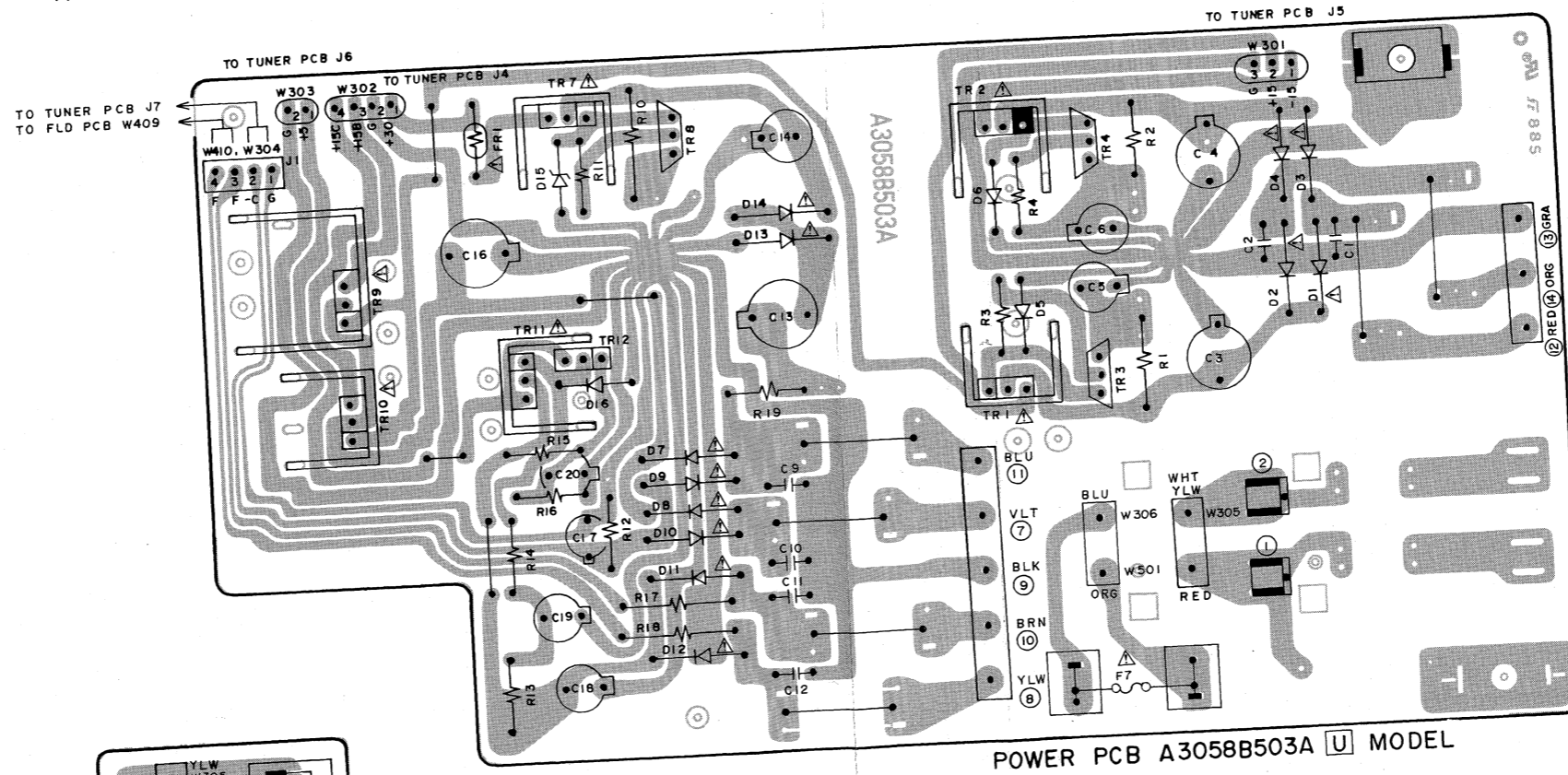
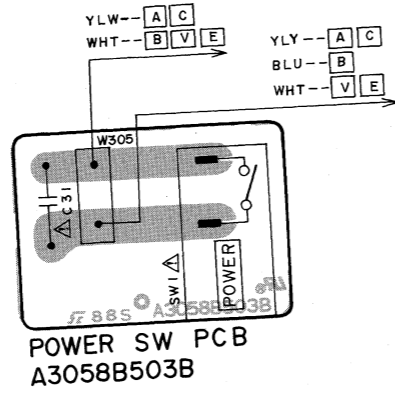
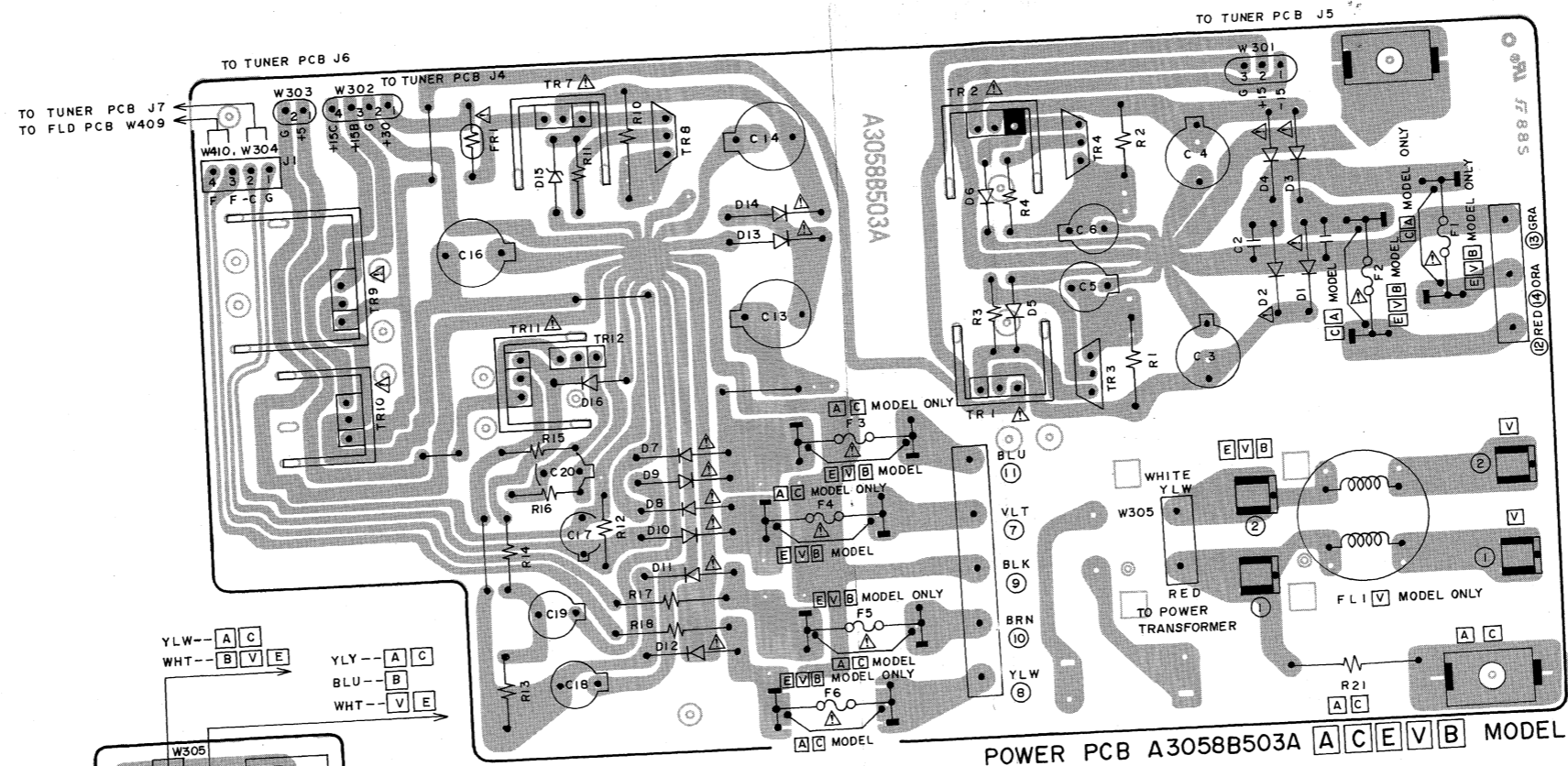

WARNING:  $\Delta$  INDICATES SAFETY CRITICAL COMPONENTS. FOR CONTINUED SAFETY, REPLACE SAFETY CRITICAL COMPONENTS ONLY WITH MANUFACTURER'S RECOMMENDED PARTS.  
 AVERTISSEMENT:  $\Delta$  IL INDIQUE LES COMPOSANTS CRITIQUES DE SÉCURITÉ. POUR MAINTENIR LE DEGRÉ DE SÉCURITÉ DE L'APPAREIL, NE REMPLACER QUE DES PIÈCES RECOMMANDÉES PAR LE FABRICANT.

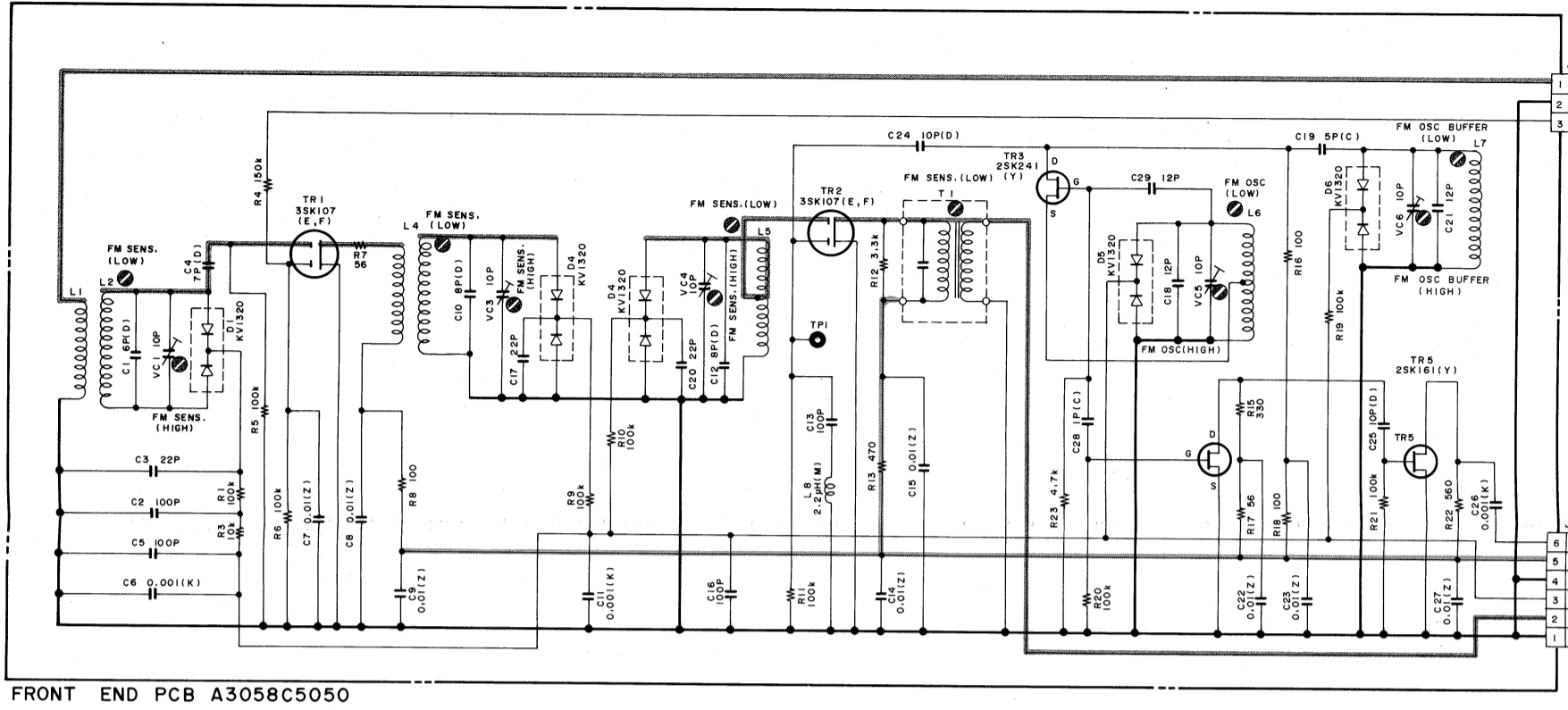

FRONT END PCB A3058C5050

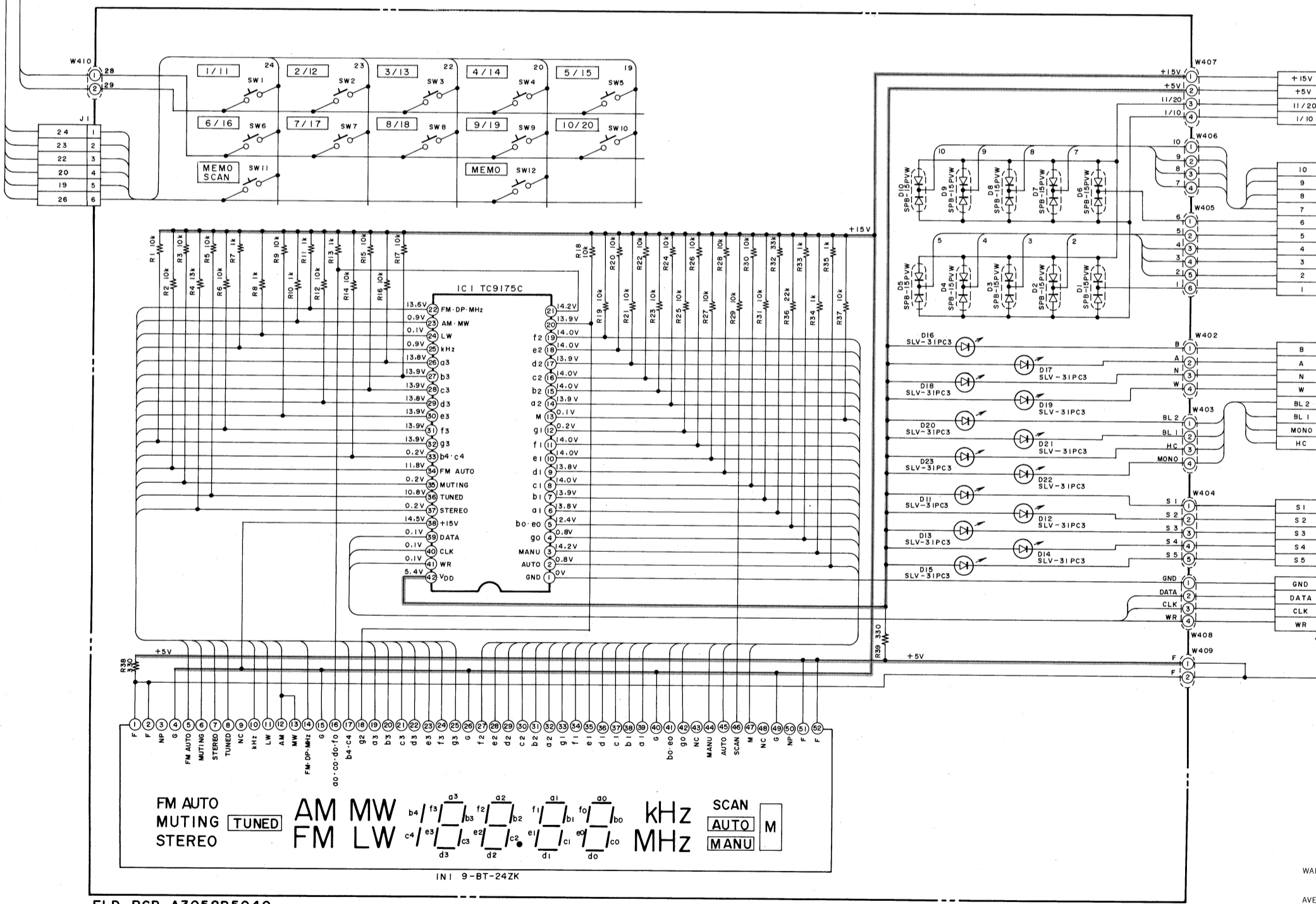

FLD PCB A3058B5040

FM AUTO  
MUTING  
STEREO

TUNED

AM MW  
FM LW

kHz  
MHz

SCAN  
AUTO  
MANU

M

INI 9-BT-24ZK



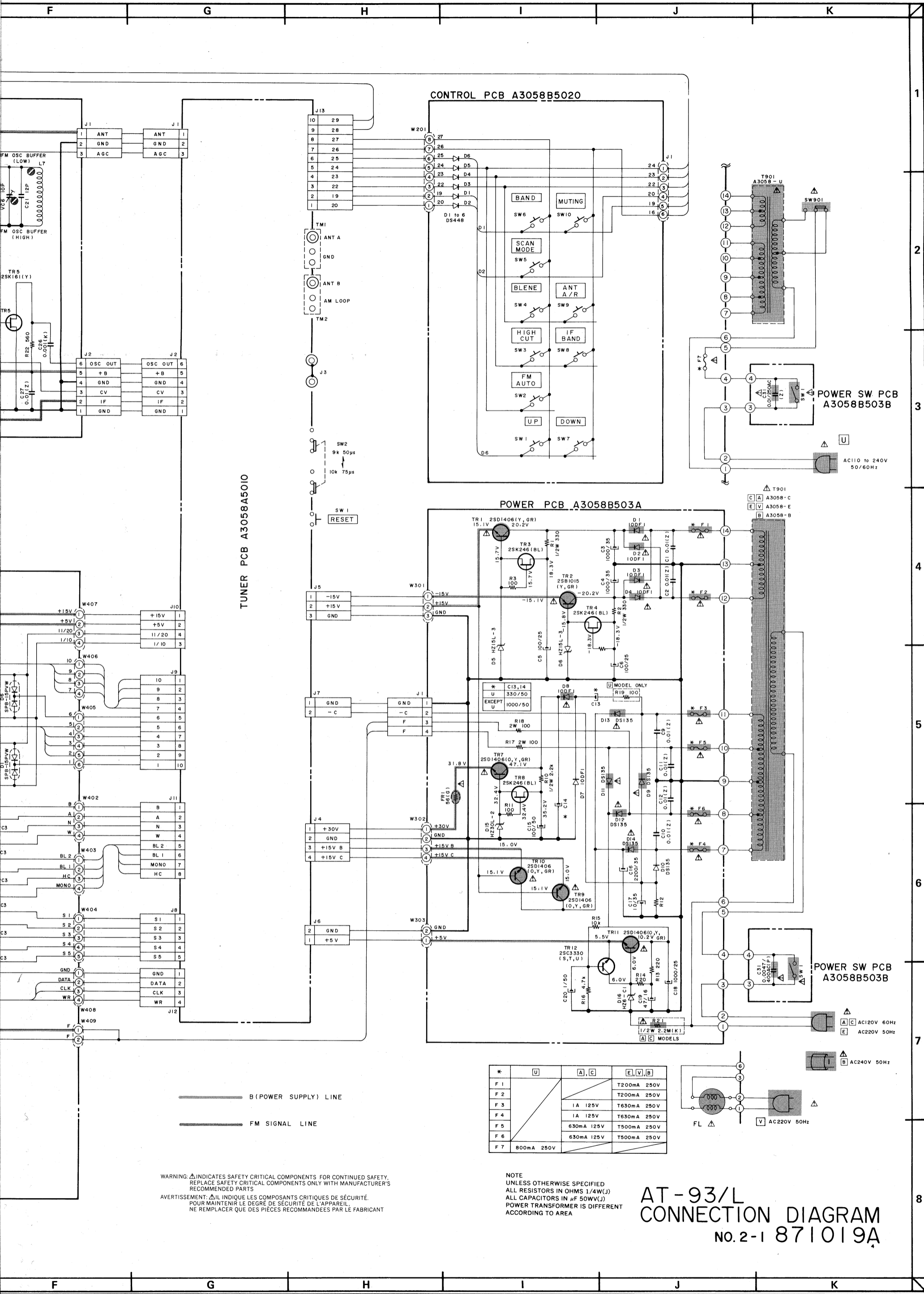

TUNER PCB A3058A5010

CONTROL PCB A3058B5020

POWER PCB A3058B503A

POWER SW PCB A3058B503B

POWER SW PCB A3058B503B

—— B (POWER SUPPLY) LINE  
 —— FM SIGNAL LINE

WARNING:  $\Delta$  INDICATES SAFETY CRITICAL COMPONENTS. FOR CONTINUED SAFETY, REPLACE SAFETY CRITICAL COMPONENTS ONLY WITH MANUFACTURER'S RECOMMENDED PARTS.  
 AVERTISSEMENT:  $\Delta$  IL INDIQUE LES COMPOSANTS CRITIQUES DE SÉCURITÉ. POUR MAINTENIR LE DEGRÉ DE SÉCURITÉ DE L'APPAREIL, NE REMPLACER QUE DES PIÈCES RECOMMANDÉES PAR LE FABRICANT.

NOTE  
 UNLESS OTHERWISE SPECIFIED  
 ALL RESISTORS IN OHMS 1/4W(J)  
 ALL CAPACITORS IN  $\mu$ F 50V(J)  
 POWER TRANSFORMER IS DIFFERENT ACCORDING TO AREA

	U	A, C	E, V, B
F 1			T200mA 250V
F 2			T200mA 250V
F 3		1A 125V	T630mA 250V
F 4		1A 125V	T630mA 250V
F 5		630mA 125V	T500mA 250V
F 6		630mA 125V	T500mA 250V
F 7		800mA 250V	

AT-93/L  
 CONNECTION DIAGRAM  
 NO. 2-1 871019A

1  
 2  
 3  
 4  
 5  
 6  
 7  
 8

AT-93/L

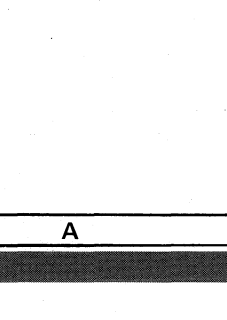
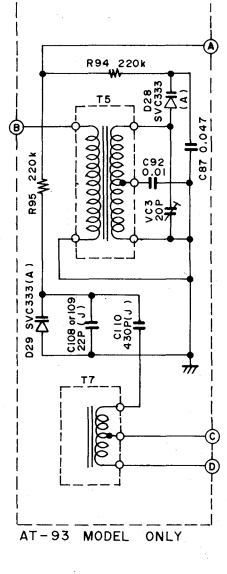
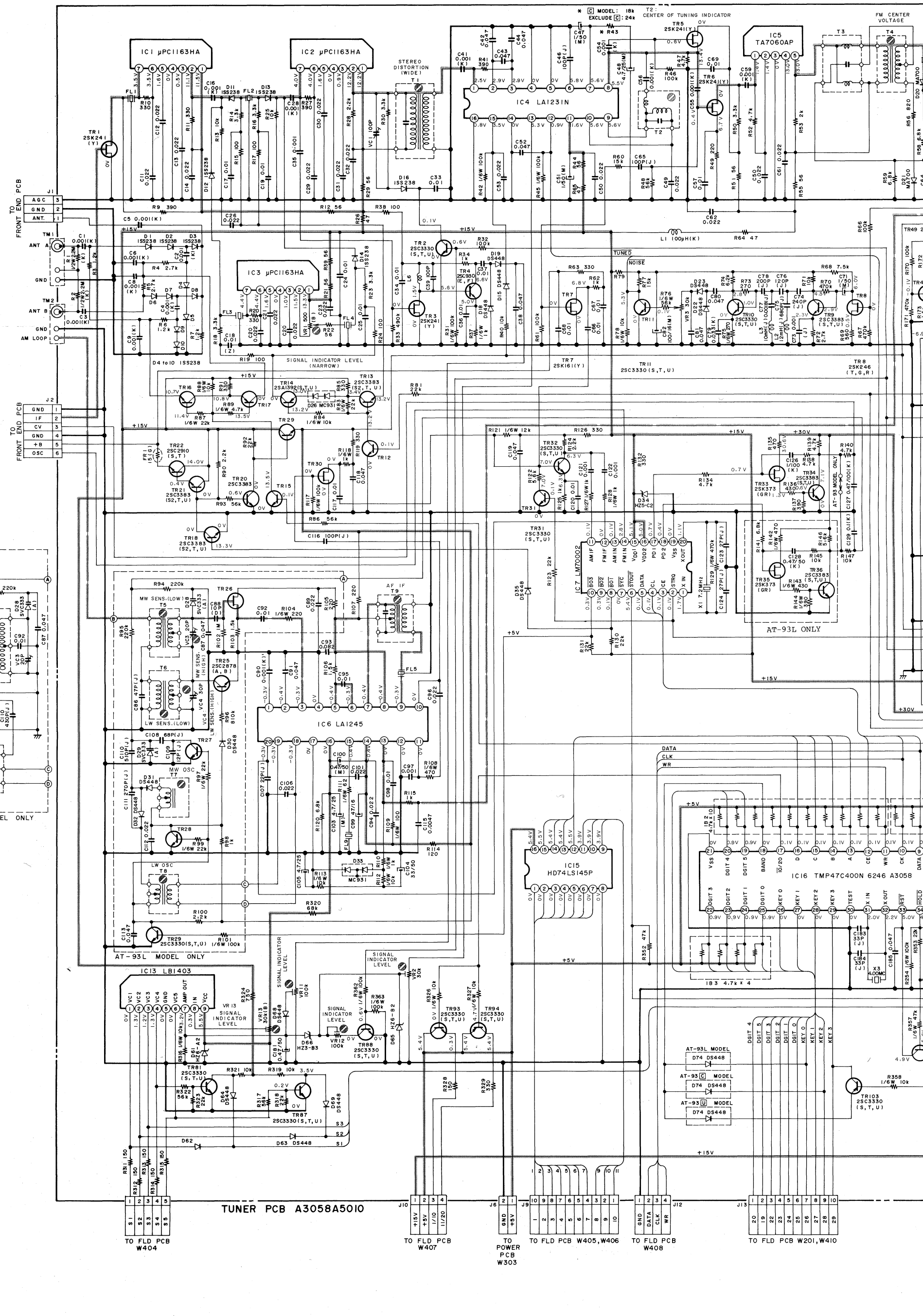

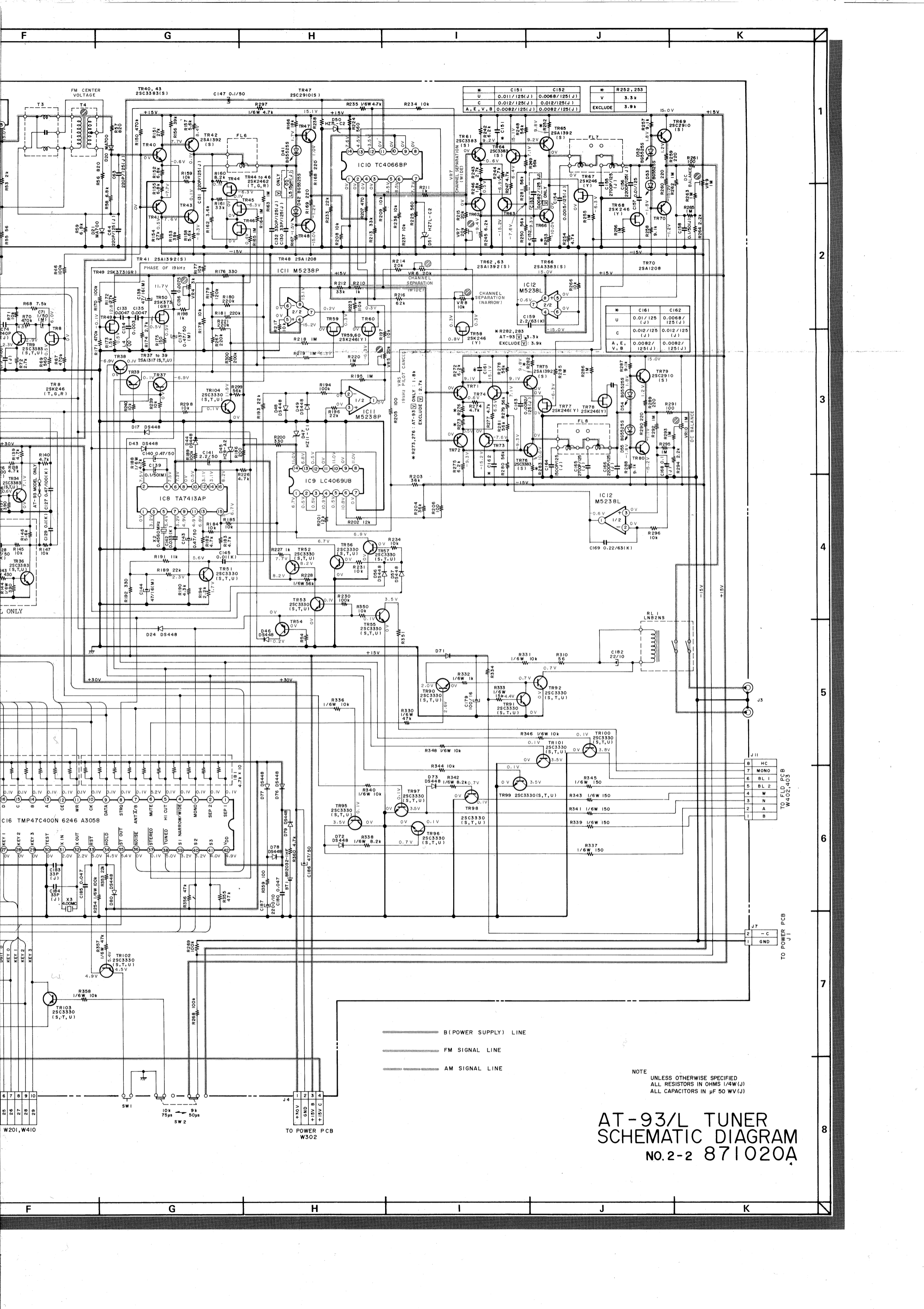

* C151	C152	* R252, 253
U 0.011/125(J)	0.0068/125(J)	V 3.3k
C 0.012/125(J)	0.012/125(J)	EXCLUDE 3.9k
A, E, V, B	0.0082/125(J)	

* C161	C162
U 0.017/125	0.0068/125(J)
C 0.012/125	0.012/125
V, E, B	0.0082/125(J)

\* R272, 276: AT-93 ONLY: 1.8k  
EXCLUDE: 2.7k

\* R282, 283: AT-93 ONLY: 3.3k  
EXCLUDE: 3.9k

- B (POWER SUPPLY) LINE
- FM SIGNAL LINE
- AM SIGNAL LINE

NOTE  
UNLESS OTHERWISE SPECIFIED  
ALL RESISTORS IN OHMS 1/4W(J)  
ALL CAPACITORS IN  $\mu$ F 50 WV(J)

# AT-93/L TUNER SCHEMATIC DIAGRAM NO.2-2 871020A

W201, W410

TO POWER PCB  
W302

TO FLD PCB  
W402, 403

TO POWER PCB  
J1

- Adjustment Parts and name
- VR1, 2, 11 ..... FM IF
  - VR3 ..... Signal Indicator Level
  - VR4 ..... Noise Detecting Level
  - VR5 ..... Phase Of 19kHz
  - VR6, 7 ..... 19kHz Pilot Cancel
  - VR8 ..... Channel Separation (WIDE)
  - VR9 (RCH) ..... Channel Separation (NARROW)
  - VR10 (LCH) ..... DC Balance
- VC1 ..... FM IF
  - VC3 ..... MW SENS (HIGH)
  - VC4 ..... LW SENS (HIGH)
- T1 ..... Stereo Distortion (WIDE)
  - T2 ..... Center Of Tuning Indication
  - T3 ..... Distortion Factor
  - T4 ..... FM Center Voltage
  - T5 ..... MW SENS (LOW)
  - T6 ..... LW SENS (LOW)
  - T7 ..... MW OSC
  - T8 ..... LW OSC
  - T9 ..... AF IF

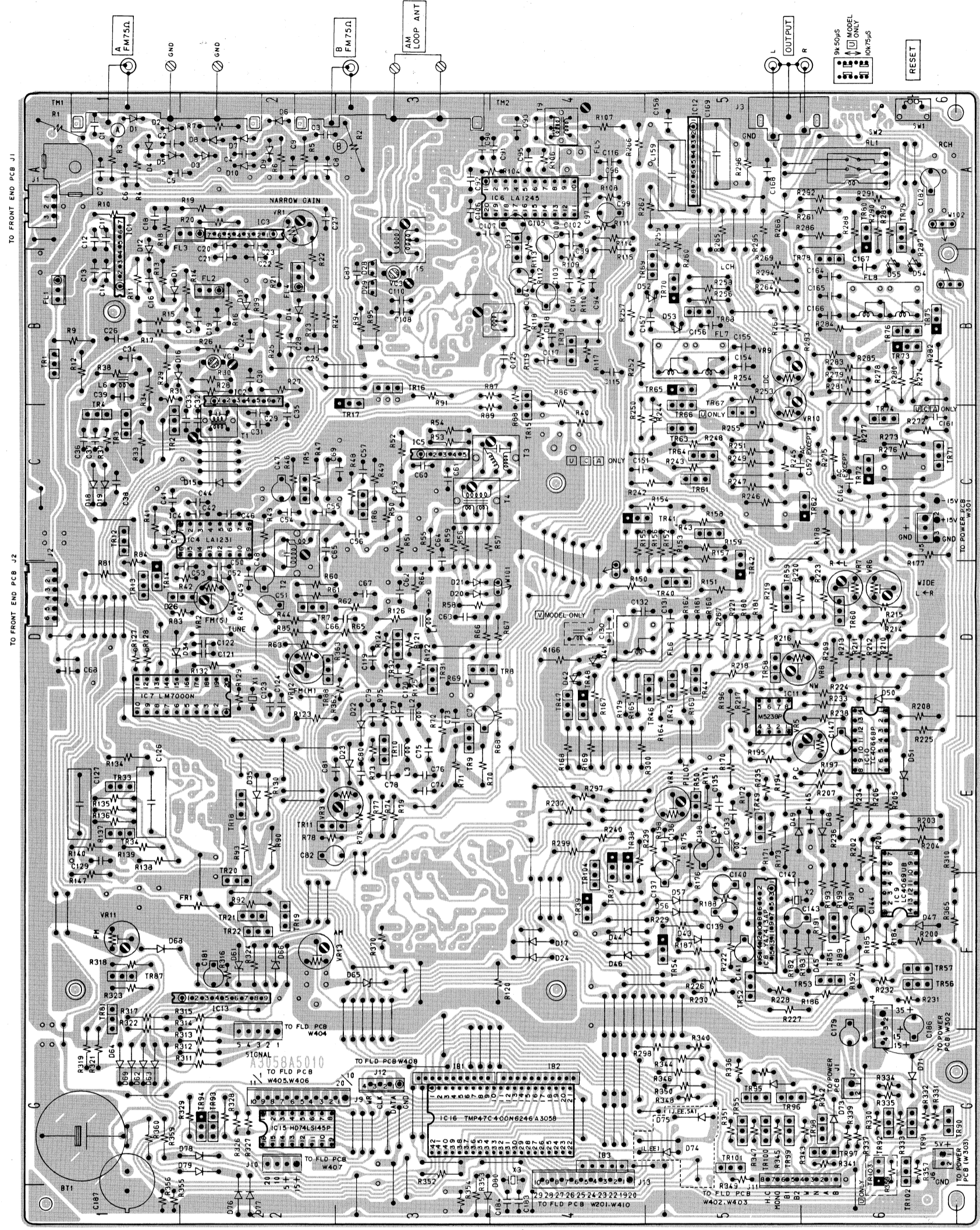

- LOCATION OF COMPONENTS
- IC 1-----B1
  - IC 2-----B2
  - IC 3-----A2
  - IC 4-----C2
  - IC 5-----C3
  - IC 6-----A4
  - IC 7-----D1
  - IC 8-----F5
  - IC 9-----F6
  - IC 10-----E6
  - IC 11-----D5
  - IC 12-----A5
  - IC 13-----F2
  - IC 15-----G2
  - IC 16-----G4

- TERMINALS
- J 1-----A1
  - J 2-----D1
  - J 4-----F6
  - J 11-----G5
  - J 12-----G3
  - J 13-----G4
  - J 10-----G2

- TRANSISTORS
- TR1-----B1
  - TR2 to 4-----C1
  - TR5, 6-----C3
  - TR7-----D3
  - TR8, 31, 32-----D3
  - TR9, 10-----E3
  - TR11, 18-----E2
  - TR12, 13, 14-----D1
  - TR15, 41-----C4
  - TR16, 17-----B3
  - TR19 to 22-----F2
  - TR26-----A3
  - TR27, 28-----B3
  - TR30-----B4
  - TR33, 34-----E1
  - TR37, 38, 104-----E4
  - TR39-----F4
  - TR42, 43-----C5
  - TR44, 45, 58, 59-----D5
  - TR47, 48-----D4
  - TR49, 50-----E5
  - TR51, 53, 56, 57-----F6
  - TR52, 54-----F5
  - TR55, 95, 96, 99-----G5
  - TR60, 101-----G5
  - TR61, 63, 64, 66-----D6
  - TR67-----C5
  - TR65, 68, 69, 70-----B5
  - TR71, 72, 74-----C6
  - TR73, 75, 76-----B6
  - TR77, 78-----B6
  - TR79, 80-----A6
  - TR81, 87-----F1
  - TR90, 91, 92-----G6
  - TR98, 102-----G6

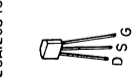
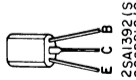
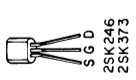
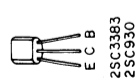
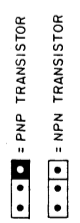

TUNER PCB A[C]V[E]U[A]3058A5010

Adjustment Parts and name

- VR1, 2, 11 ..... Signal Indicator Level
- VR3 ..... Noise Detecting Level
- VR4 ..... Phase Of 19 kHz
- VR5 ..... 19 kHz Pilot Cancel
- VR6, 7 ..... Channel Separation (WIDE)
- VR8 ..... Channel Separation (NARROW)
- VR9 (RCH) ..... DC Balance
- VR10 (LCH) ..... DC Balance

- VC1 ..... FM IF
- VC3 ..... MW SENS (HIGH)
- VC4 ..... LW SENS (HIGH)

- T1 ..... Stereo Distortion (WIDE)
- T2 ..... Center Of Tuning Indication
- T3 ..... Distortion Factor
- T4 ..... FM Center Voltage
- T5 ..... MW SENS (LOW)
- T6 ..... LW SENS (LOW)
- T7 ..... LW OSC
- T8 ..... AF IF
- T9 ..... AF IF

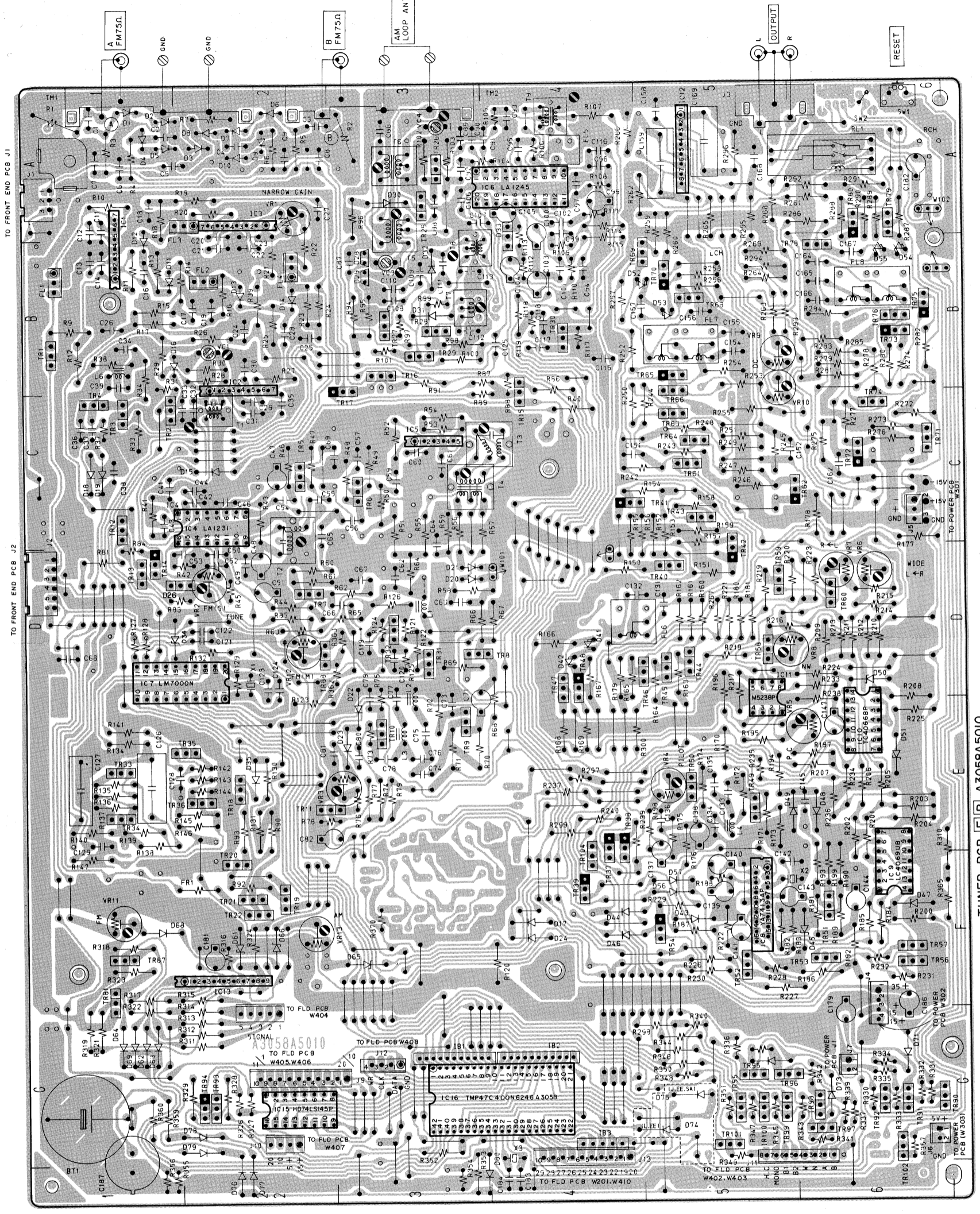

LOCATION OF COMPONENTS

IC 5	.....	B1
IC 1	.....	B2
IC 2	.....	A2
IC 3	.....	C2
IC 4	.....	C3
IC 5	.....	C3
IC 6	.....	A4
IC 7	.....	D1
IC 8	.....	F5
IC 9	.....	F6
IC 10	.....	E6
IC 11	.....	D5
IC 12	.....	A5
IC 13	.....	P2
IC 15	.....	G2
IC 16	.....	G4

TERMINALS

J 1	.....	A1
J 2	.....	D1
J 4	.....	F6
J 11	.....	G5
J 12	.....	G3
J 13	.....	G4
J 10	.....	G2

TRANSISTORS

TR1	.....	B1
TR2 to 4	.....	C1
TR5, 6	.....	C3
TR7	.....	D3
TR8, 31, 32	.....	D3
TR9, 10	.....	E3
TR11, 18	.....	E2
TR12, 13, 14	.....	D1
TR15, 41	.....	C4
TR16, 17	.....	B3
TR19 to 22	.....	F2
TR26	.....	A3
TR27, 28	.....	B3
TR30	.....	B4
TR33, 34	.....	E1
TR37, 38, 104	.....	E4
TR39	.....	F4
TR42, 43	.....	C5
TR44, 45, 56, 59	.....	D5
TR47, 48	.....	D4
TR49, 50	.....	E5
TR51, 53, 56, 57	.....	F5
TR52, 54	.....	F5
TR55, 95, 96, 99	.....	G5
100, 101	.....	D6
TR61, 63, 64, 66	.....	C5
67	.....	C5
TR65, 68, 69, 70	.....	B5
TR71, 72, 74	.....	C6
TR73, 75, 76	.....	B6
77, 78	.....	B6
TR79, 80	.....	A6
TR81, 87	.....	F1
TR90, 91, 92	.....	G6
98, 102	.....	G6

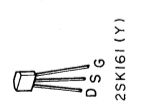
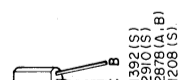
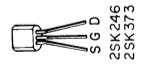
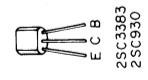
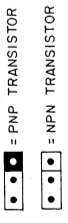

TUNER PCB [E] A3058A5010