

AKAI SERVICE MANUAL

AM-U01

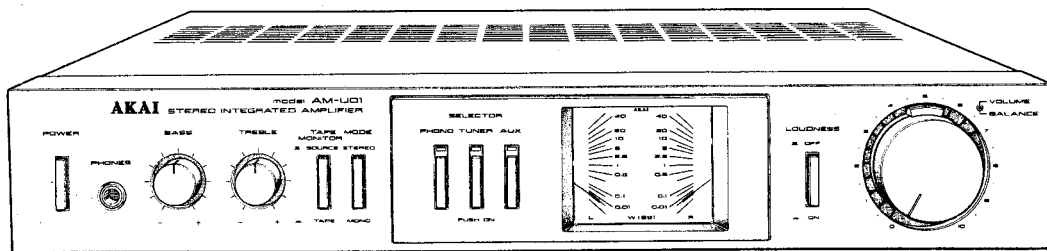

STEREO INTEGRATED AMPLIFIER

MODEL **AM-U01**

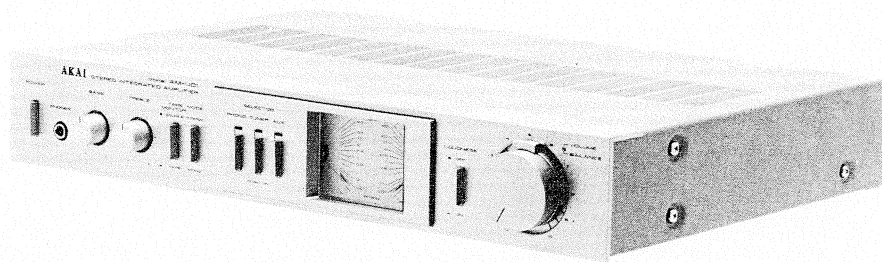

STEREO INTEGRATED AMPLIFIER

MODEL **AM-U01**

ALSO APPLICABLE TO BLACK PANEL MODEL

SECTION 1	SERVICE MANUAL	3
SECTION 2	PARTS LIST	15
SECTION 3	SCHEMATIC DIAGRAM	24

SECTION 1

SERVICE MANUAL

TABLE OF CONTENTS

I. TECHNICAL DATA	4
II. DISMANTLING OF UNIT	5
III. CONTROLS	6
IV. PRINCIPAL PARTS LOCATION	7
V. VOLTAGE CONVERSION	8
VI. LEVEL METER ADJUSTMENT	9
VII. COMPOSITION OF VARIOUS P.C BOARDS	10

For basic adjustments, measuring methods, and operating principles, refer to GENERAL TECHNICAL MANUAL.

I. TECHNICAL DATA

RATED POWER OUTPUT (2-CHANNEL DRIVEN)		20 watts per channel, minimum RMS, at 8 ohms from 40 Hz to 20 kHz with no more than 0.3% total harmonic distortion.
POWER BANDWIDTH (IHF)		10 Hz to 40 kHz/8 ohms (Total harmonic distortion: 0.3%)
SIGNAL TO NOISE RATIO (IHF)	PHONO AUX	Better than 70 dB Better than 90 dB
RESIDUAL NOISE		Less than 1.3 mV at 8 ohms
CHANNEL SEPARATION (IHF)	PHONO AUX	Better than 50 dB at 1,000 Hz Better than 50 dB at 1,000 Hz
DAMPING FACTOR		More than 30 (1 kHz, 8 ohms)
OUTPUT	SPEAKERS HEADPHONE	4 to 16 ohms 4 to 16 ohms
INPUT SENSITIVITY/IMPEDANCE	PHONO AUX TUNER TAPE	3 mV/47 kohms 150 mV/100 kohms 150 mV/100 kohms PIN: 150 mV/100 kohms DIN: 150 mV/100 kohms
OUTPUT LEVEL	TAPE REC	PIN: 150 mV/5 kohms DIN: 30 mV/80 kohms
FREQUENCY RESPONSE	PHONO AUX	30 Hz to 15kHz, +1 dB, -1 dB (RIAA) 10 Hz to 50 kHz, +0 dB, -3 dB
TONE CONTROL	BASS TREBLE	±8 dB at 100 Hz ±8 dB at 10 kHz
LOUDNESS CONTROL		+10 dB at 100 Hz, +6 dB at 10 kHz
POWER REQUIREMENTS		120 V, 60 Hz for Canada 220 V, 50 Hz for Europe except UK 240 V, 50 Hz for UK and Australia 110V/220V/240V. 50/60 Hz internally switchable for others.
POWER CONSUMPTION		110 W
DIMENSIONS		440 (W) x 75 (H) x 318 (D) mm (17.3 x 3.0 x 12.5 inches)
WEIGHT		5.8 kg (12.8 lbs)

* For improvement purposes, specifications and design are subject to change without notice.

II. DISMANTLING OF UNIT

In case of trouble, etc. necessitating dismantling, please dismantle in the order shown in the photographs, Reassemble in reverse order.

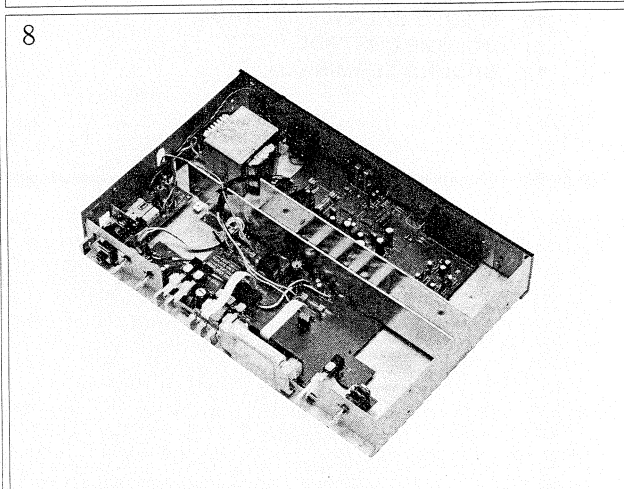
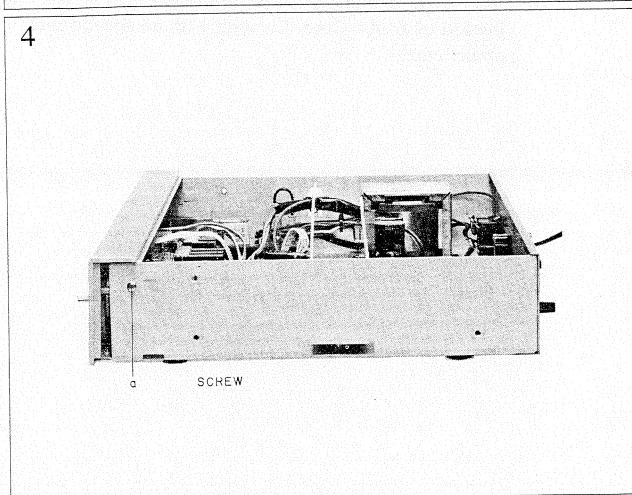
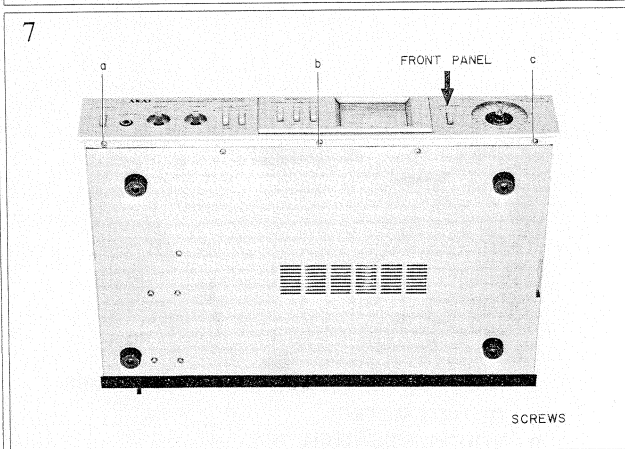
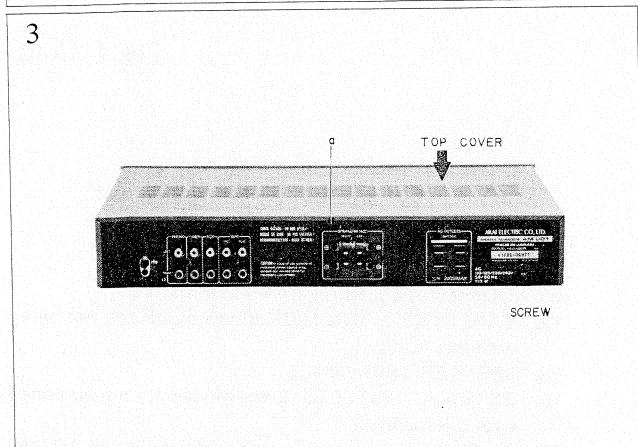
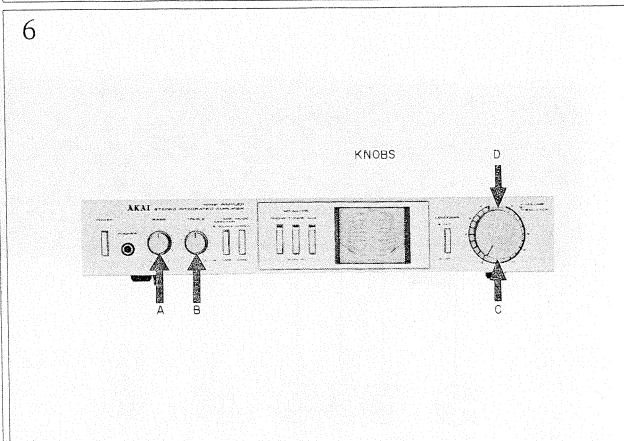
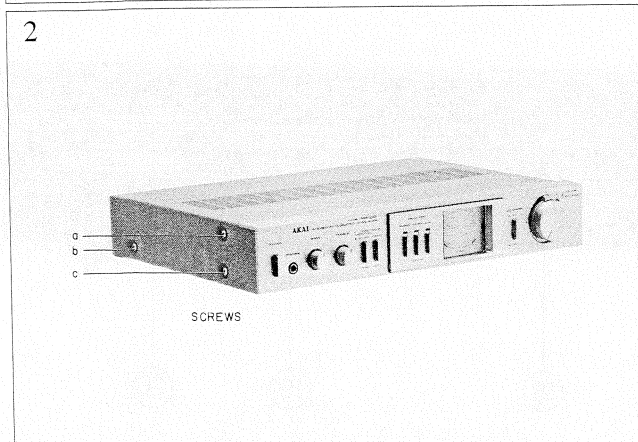
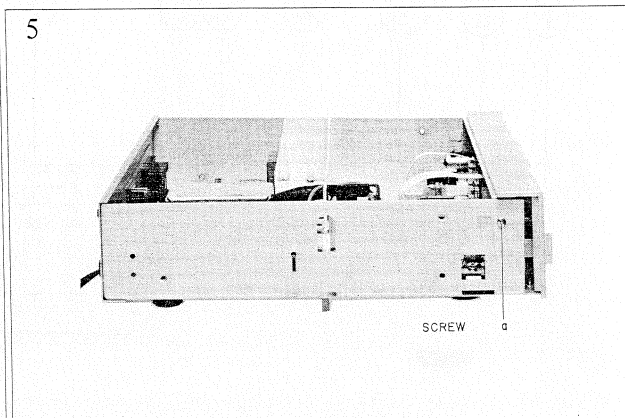
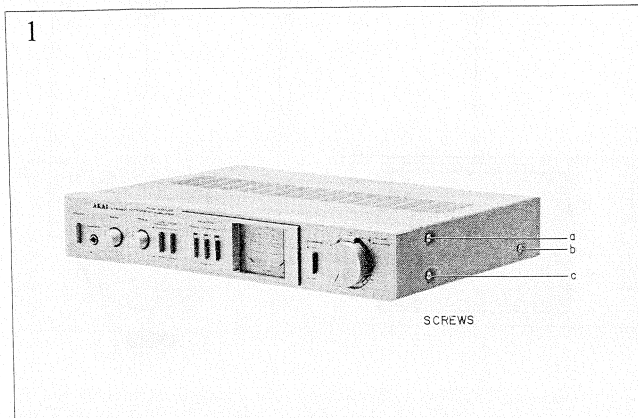

III. CONTROLS

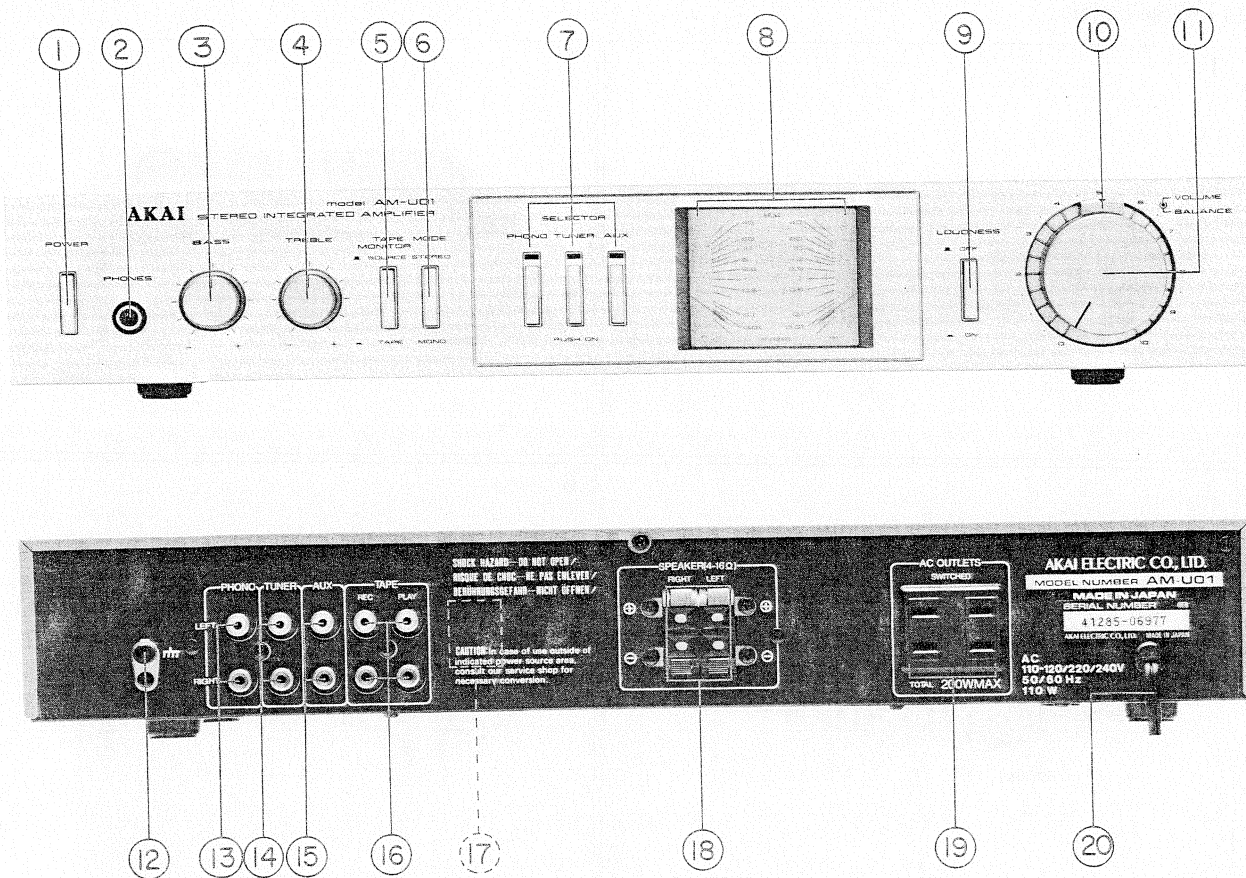

Fig. 1 Controls

1. POWER SWITCH
2. HEADPHONE JACK
3. BASS CONTROL
4. TREBLE CONTROL
5. TAPE MONITOR SWITCH
6. MODE SELECTOR
7. INPUT SELECTOR AND INDICATOR LAMPS
8. OUTPUT METER
9. LOUDNESS SWITCH
10. STEREO BALANCE CONTROL
11. VOLUME CONTROL
12. GROUND TERMINAL
13. PHONO TERMINALS
14. TUNER TERMINALS
15. AUX TERMINALS
16. TAPE SYSTEM REC/PLAY TERMINALS
17. TAPE SYSTEM DIN JACK (Some models do not have with this facility.)
18. SPEAKER TERMINALS
19. EXTRA AC OUTLETS (Some models are not equipped with this facility.)
20. AC CORD (Some models are equipped with an AC Inlet instead of an AC Cord. Connect with an appropriate power cord.)

IV. PRINCIPAL PARTS LOCATION

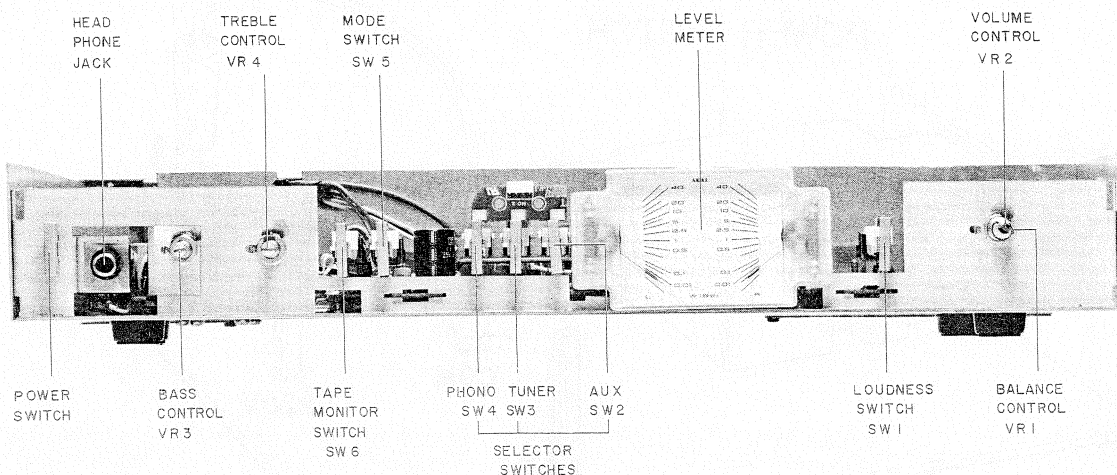

Fig. 2 Front View

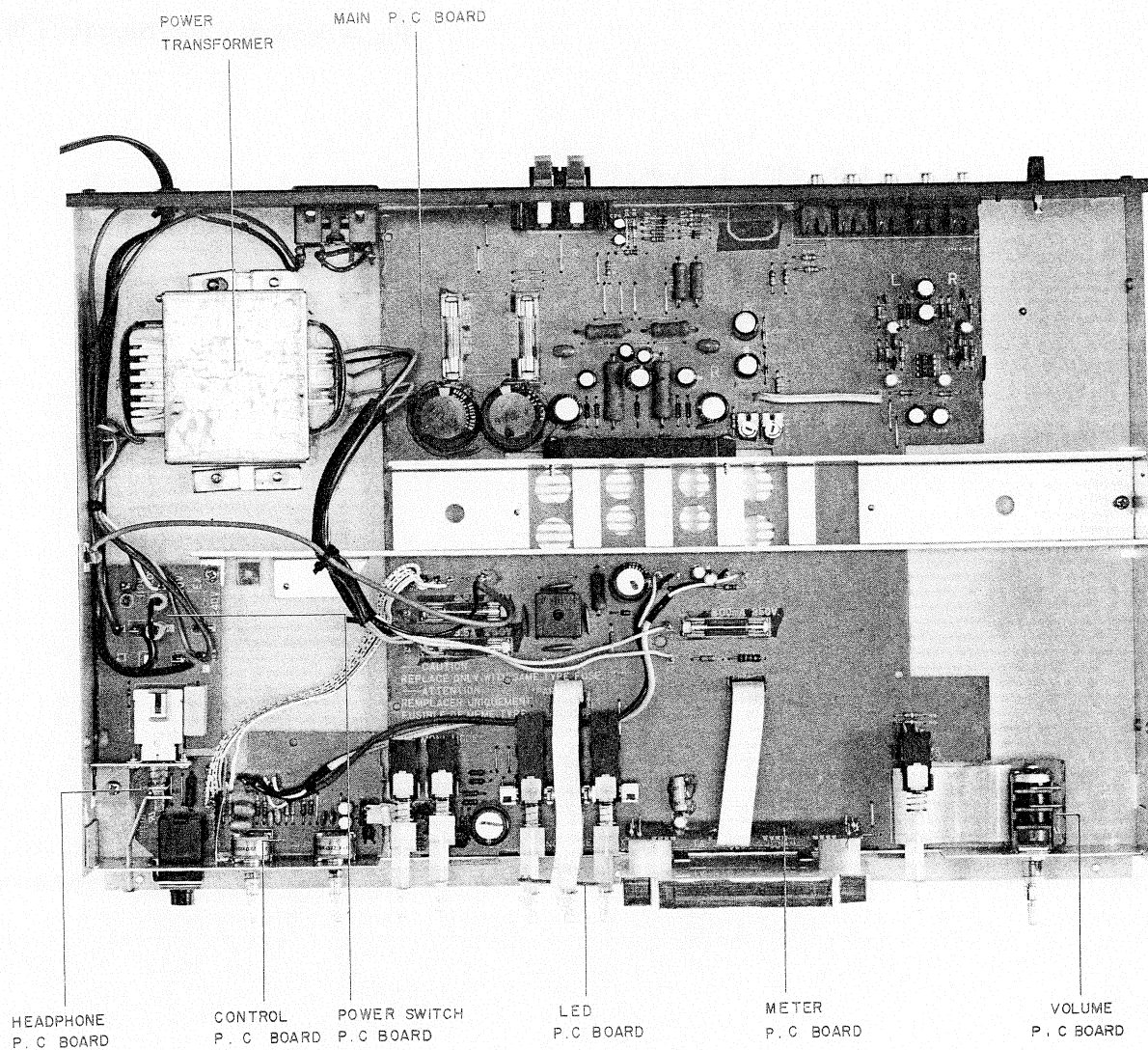

Fig. 3 Top view

V. VOLTAGE CONVERSION

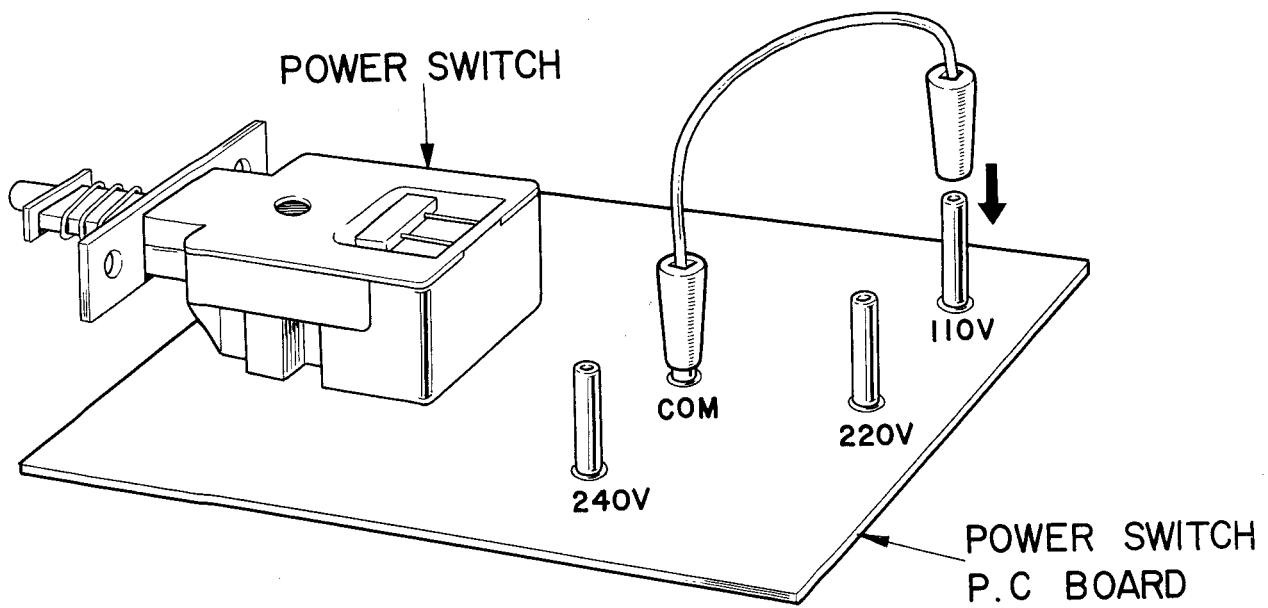

Fig. 4 Voltage Conversion (U/T Model)

This machine can be set to 110 – 120V, 220V, or 240V as required. Each machine is preset at the factory according to destination. However, if voltage change is necessary, this can be accomplished as follows:

1. Disconnect Power Cord.
2. Loosen holding screws and remove top panel.
3. Remove Line Voltage wire and fit onto proper pins, explicitly following the printed instructions.

VI. LEVEL METER ADJUSTMENT

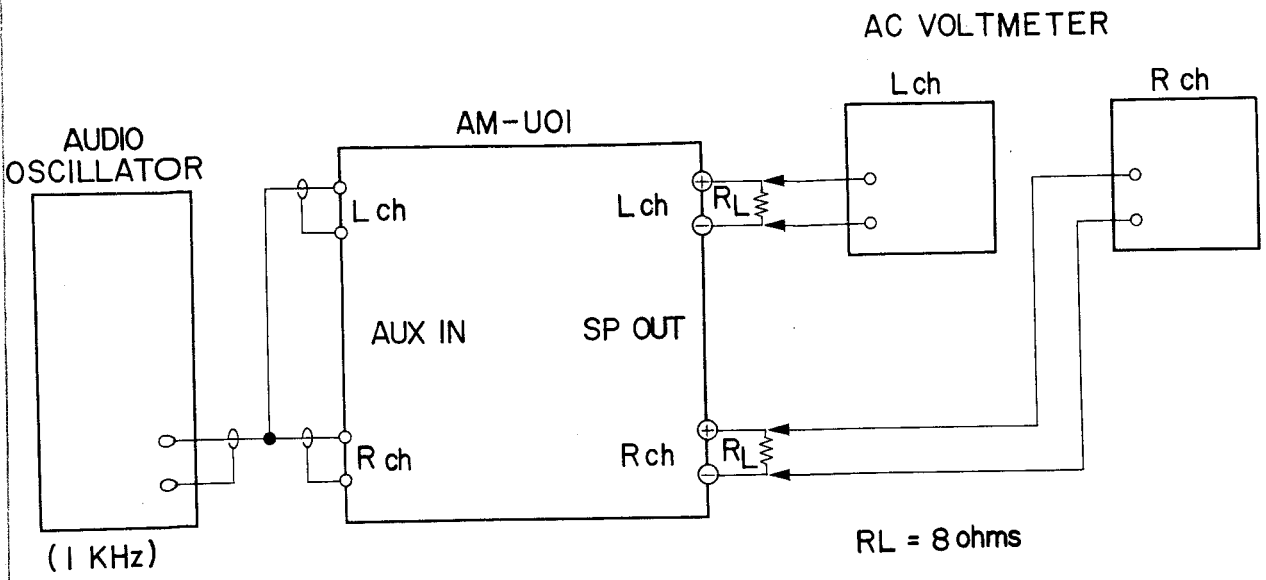
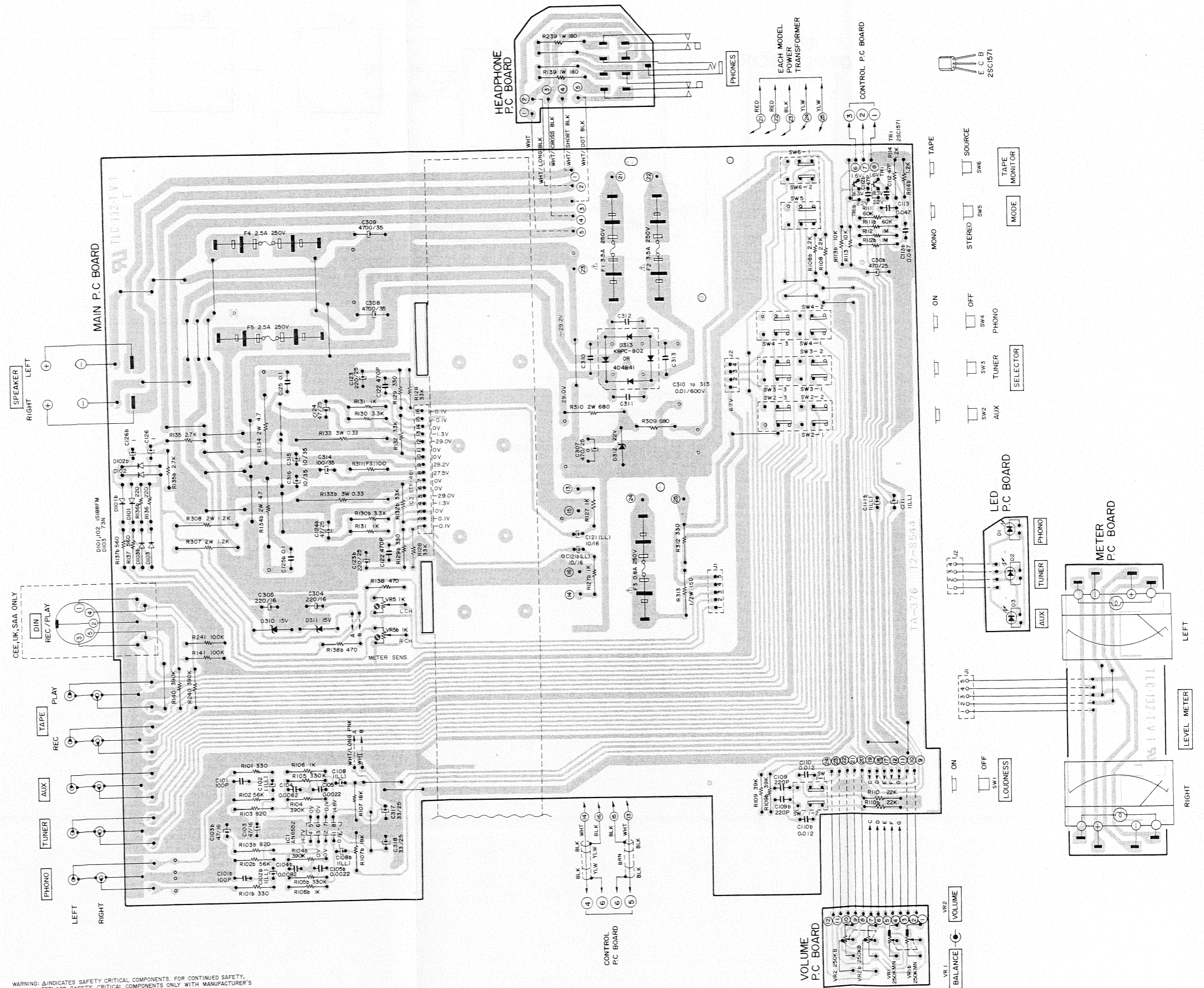

Fig. 5 Instrument Connections

1. Connect in Fig. 5, and input a 1 kHz Sine wave.
2. Adjust the Volume control until the at both terminals has a load resistance R_L of 12.65 V.
3. Next adjust VR 101 (L-ch) and VR 201 (R-ch) until the Level Meter reads 20 W.

VII. COMPOSITION OF VARIOUS P.C BOARDS

1. MAIN P.C BOARD, VOLUME P.C BOARD, HEADPHONE P.C BOARD AND METER P.C BOARD



WARNING: Δ INDICATES SAFETY CRITICAL COMPONENTS. FOR CONTINUED SAFETY, REPLACE SAFETY CRITICAL COMPONENTS ONLY WITH MANUFACTURER'S RECOMMENDED PARTS.
 AVERTISSEMENT: Δ IL INDIQUE LES COMPOSANTS CRITIQUES DE SÛRETÉ. POUR MAINTENIR LE DEGRÉ DE SÛRETÉ DE L'APPAREIL, NE REMPLACER LES COMPOSANTS DONT LE FONCTIONNEMENT EST CRITIQUE POUR LA SÛRETÉ QUE PAR DES PIÈCES RECOMMANDÉES PAR LE FABRICANT.

2. CONTROL P.C BOARD

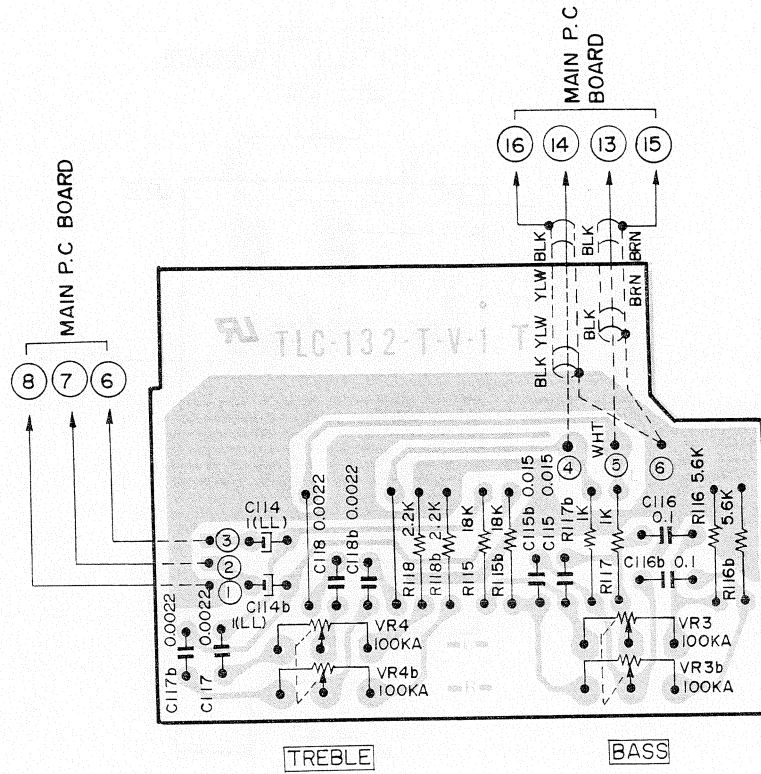

3. POWER SWITCH P.C BOARD (U/T)

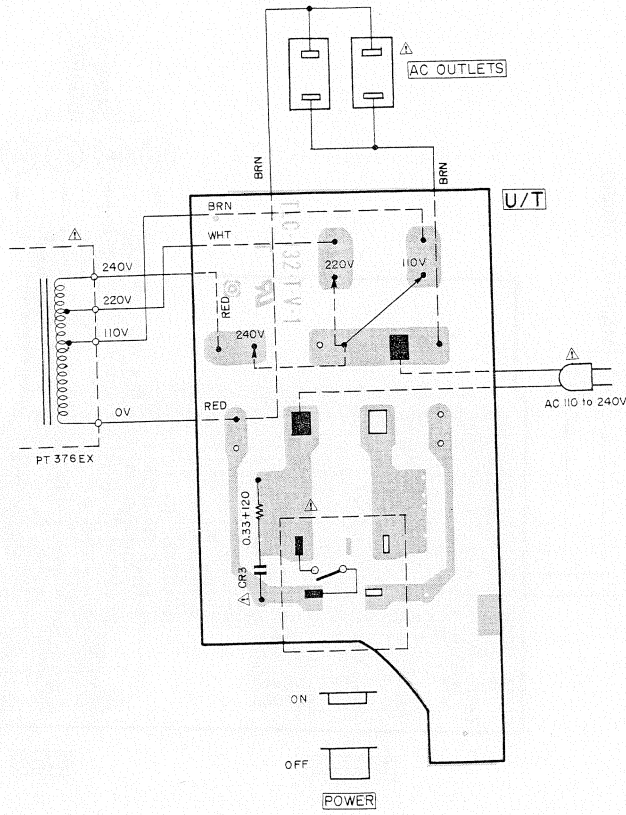

4. POWER SWITCH P.C BOARD (CSA)

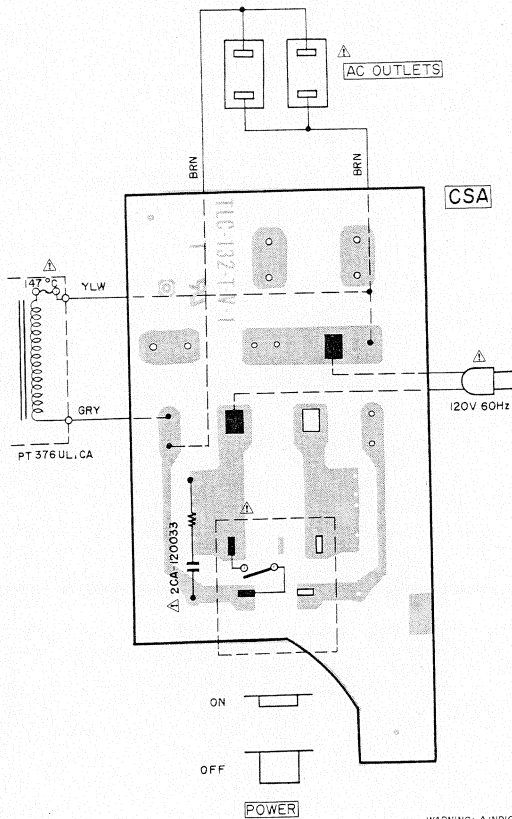

WARNING: ⚠ INDICATES SAFETY CRITICAL COMPONENTS. FOR CONTINUED SAFETY, REPLACE SAFETY CRITICAL COMPONENTS ONLY WITH MANUFACTURER'S RECOMMENDED PARTS.
 AVERTISSEMENT: ⚠ IL INDIQU LES COMPOSANTS CRITIQUES DE SÛRETÉ. POUR MAINTENIR LE DEGRÉ DE SÛRETÉ DE L'APPAREIL, NE REMPLACER LES COMPOSANTS DONT LE FONCTIONNEMENT EST CRITIQUE POUR LA SÛRETÉ QUE PAR DES PIÈCES RECOMMANDÉES PAR LE FABRICANT.

5. POWER SWITCH P.C BOARD (CEE)

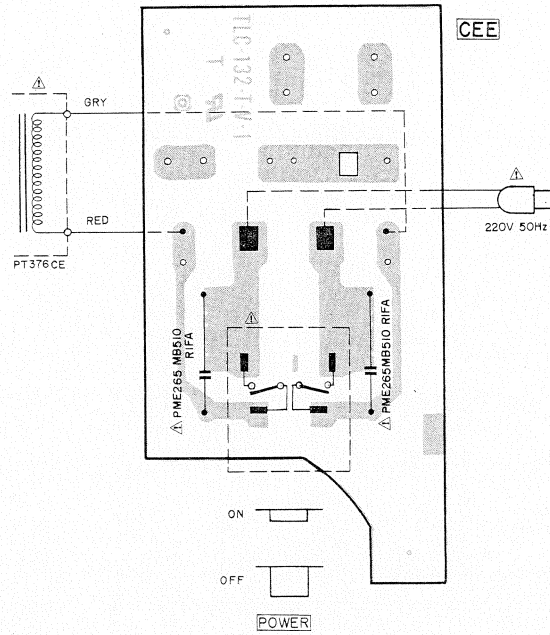

6. POWER SWITCH P.C BOARD (UK, SAA)

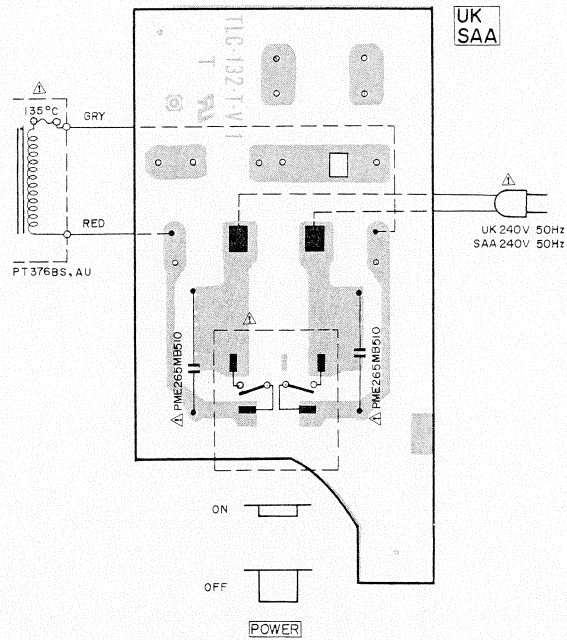

WARNING: Δ INDICATES SAFETY CRITICAL COMPONENTS. FOR CONTINUED SAFETY, REPLACE SAFETY CRITICAL COMPONENTS ONLY WITH MANUFACTURER'S RECOMMENDED PARTS.

AVERTISSEMENT: Δ IL INDIQUE LES COMPOSANTS CRITIQUES DE SÛRETÉ. POUR MAINTENIR LE DEGRÉ DE SÛRETÉ DE L'APPAREIL, NE REMPLACER LES COMPOSANTS DONT LE FONCTIONNEMENT EST CRITIQUE POUR LA SÛRETÉ QU'EN PAR DES PIÈCES RECOMMANDÉES PAR LE FABRICANT.

SECTION 2

PARTS LIST

TABLE OF CONTENTS

1. RECOMMENDED SPARE PARTS LIST	18
2. AMP P.C BOARD BLOCK	19
3. ASSEMBLY BLOCK	20
4. FINAL ASSEMBLY BLOCK	22
INDEX	23

Resistor and Capacitor which is not listed in this parts list, please refer to
COMMON LIST FOR SERVICE PARTS.

HOW TO USE THIS PARTS LIST

1. This parts list is compiled by various individual blocks based on assembly process.
2. When ordering parts, please describe parts number, serial number, and model number in detail.
3. How to read list.

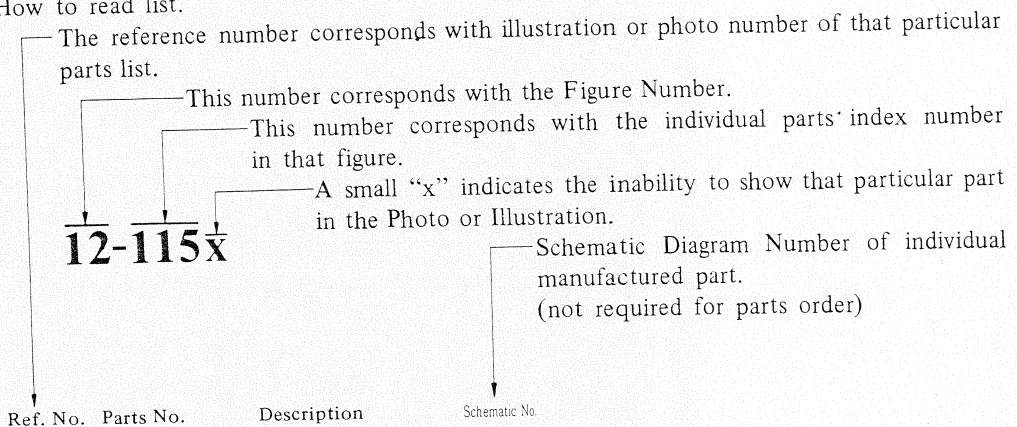

4. The symbol numbers shown on the P.C. Board list can be matched with the Composite Views of components of the Schematic Diagram or Service Manual.
5. The indications of Resistors and Capacitors in the photos of P.C. Board are being eliminated.
6. The shape of the parts and parts name, etc. can be confirmed by comparing them with the parts shown on the Electrical Parts Table of P.C. Board.
7. Both the kind of part and installation position can be determined by the Parts Number. To determine where a parts number is listed, utilize Parts Index at end of Parts List.
It is necessary first of all to find the Parts Number. This can be accomplished by using the Reference Number listed at right of parts number in the Parts Index. (meaning of ref. no. outlined in Item 3 above).
8. Utilize separate "Price List for Parts" to determine unit price. The most simple method of finding parts Price is to utilize the reference number.

CAUTION:

1. When placing an order for parts, be sure to list the parts no. model no., and description. There are instances in which if any of this information is omitted, parts cannot be shipped or the wrong parts will be delivered.
2. Please be careful not to make a mistake in the parts no. If the parts no. is in error, a part different from the one ordered may be delivered.
3. Because parts number and parts unit supply in the Preliminary Service Manual (Basic Parts List) may be partially changed, please use this parts list for all future reference.

WARNING: △ INDICATES SAFETY CRITICAL COMPONENTS. FOR CONTINUED SAFETY, REPLACE SAFETY CRITICAL COMPONENTS ONLY WITH MANUFACTURER'S RECOMEMNDED PARTS.

AVERTISSEMENT: △ IL INDIQU LES COMPOSANTS CRITIQUES DE SURETE. POUR MAINTENIR LE DEGRE DE SECURITE DE L'APPAREIL NE REMPLACER LES COMPOSANTS DONT LE FONCTIONNEMENT EST CRITIQUE POUR LA SECURITE QUE PAR DES PIECES RECOMMANDEES PAR LE FABRICANT.

AC INLET SYSTEM

This model is equipped with an AC INLET SYSTEM. Please refer to the AC INLET SYSTEM CHART below for the specific type. By the AC INLET SYSTEM, AC (mains) cord can be connected to and disconnected from the model because the model is provided with socket exclusively for AC (mains) cord on its main body. Please note, however, that certain models are not equipped with this system and has a built-in AC (mains) cord as before.

AC INLET SYSTEM CHART

CLASS I

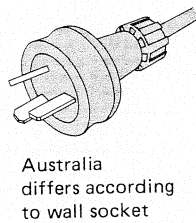
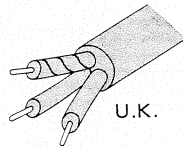
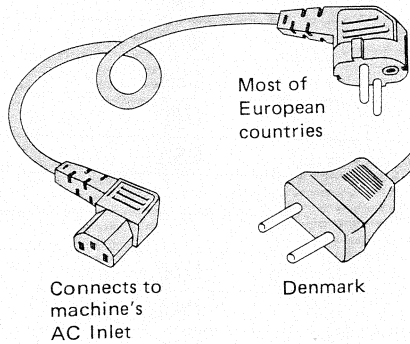
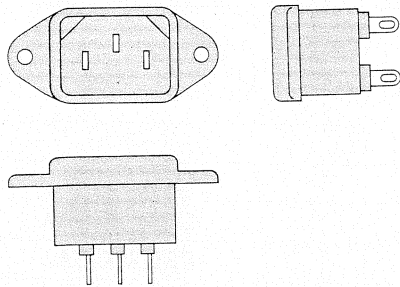

CLASS II

☐ This mark indicating double insulation will be attached to machine's rear panel

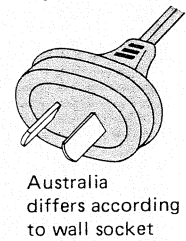
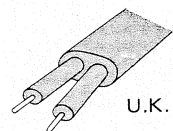
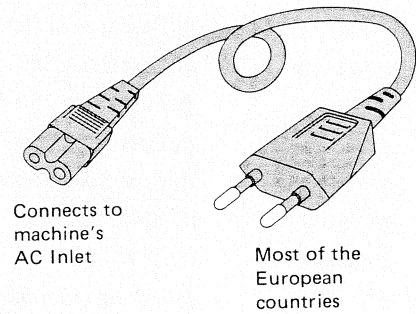
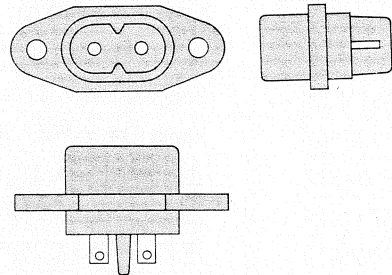

Picture 1
AC INLET
to be
installed
on machines

Picture 2
AC (mains)
cord

Parts List for AC (mains) Cord Set

	Standard	Description	Type of AC Inlet	Parts No.
Class I	CEE	Cord Set CEE (3 cores)	3P	EW302993
	BEAB	Cord Set BEAB (3 cores)	3P	EW302994
	SAA	Cord Set SAA (3 cores)	3P	EW302996
	U/T	Cord Set U/T (3 cores)	3P	EW302646
Class II	CEE	Cord Set CEE (2 cores)	2P	EW638144
	BEAB	Cord Set BEAB (2 cores)	2P	EW302995
	SAA	Cord Set SAA (2 cores)	2P	EW302991
	U/T	Cord Set U/T (2 cores)	2P	EW302899

1. RECOMMENDED SPARE PARTS LIST

Because, if the parts listed below are on hand, almost any repair can be accomplished, we suggest that you stock these Recommended Spare Parts Items.

Parts No.	Description	Note
BT704530	△ Power Trans. PT-376 (UK)	UK, SAA
BT704529	△ Power Trans. PT-376 (CEE)	CEE
BT704528	△ Power Trans. PT-376 (UL, CSA)	CSA
BT704527	△ Power Trans. PT-376 (U/T)	U/T
ED704547	Diode KBPC802	
ED379855	Germanium Diode 1N60P	
ED704548	LED SLP-241D-01	
ED624903	Silicon Diode 1S2473	
ED313623	Zener Diode HZ22-3	
ED237960	Zener Diode WZ-150	
EF704522	△ Fuse T1.6A 250V	CEE, UK, SAA
EF704514	△ Fuse T0.8A 250V CEE	CEE, UK, SAA
EF704517	△ Fuse T3.5A 250V	CEE, UK, SAA
EF704512	△ Fuse 0.8A 250V	U/T
EF704513	△ Fuse 0.8A 250VSS-2 UL CSA	CSA
EF704519	△ Fuse 2.5A 250V	U/T
EF704521	△ Fuse 3.0A 250V UL CSA	CSA
EF704515	△ Fuse 3.5A 250V	U/T
EF704516	△ Fuse 3.5A 250V UL CSA	CSA
EI704497	IC AN6552	
EI704498	IC STK-461	
EJ704539	△ Voltage Change Wire	U/T
EJ704537	△ AC Outlet (CSA)	CSA
EJ704536	△ AC Outlet UL	U/T
EJ704505	Headphone Jack S-G2305	
EM704508	Meter MG-108U	
EM704509	Meter (BL) MG-108U	
ER704523	△ Spark Killer CR-3	U/T
ER704525	△ Spark Killer ECQ-U1A 103ME	CSA
ER704526	△ Spark Killer 0.01μF PME265MB51	CEE, UK, SAA
ES310839	△ Push SW. SDG1P-E 5A/80A 250V	U/T
ES665875	△ Push SW. SDG1P-J TV-3 UL/CSA	CSA
ES665807	△ Push SW. SDG5P-E 5A/80A 250V	CEE, UK, SAA
ES704502	Push SW. R215418	
ES704501	Push SW. R215420	
ET223446	Transistor 2SC1571NP (G)(H)	
EV704503	Double-Axial 4-Throw/Vol. 250kBx2 250kAx2	
EV704504	Single-Axial 2-Throw/Vol. 100kAx2	
EW704534	△ Power Cord GTBS-2F	UK
EW704532	△ Power Cord KP-10 SPT-1 (UL, CSA)	CSA
EW704531	△ Power Cord KP-205A VFF (U/T)	U/T
EW704533	△ Power Cord KP-419C LTCE2F (CEE)	CEE
EW704554	△ Power Cord KP-560 LTSA-2 SAA	SAA

2. AMP P.C BOARD BLOCK

Symbol No.	Parts No.	Description	Schematic No.
2-IC1	EI704497	IC AN6552	T4-28958
2-IC2	EI704498	IC STK-461	T4-28959
2-TR101	ET223446	Transistor 2SC1571NP (G)(H)	45-1-238
2-D101,102	ED379855	Germanium Diode 1N60P	45-3-7
2-D103	ED624903	Silicon Diode 1S2473	45-3-28
2-D305	ED624903	Silicon Diode 1S2473	45-3-28
2-D310,311	ED237960	Zener Diode WZ-150	45-6-67
2-D312	ED313623	Zener Diode HZ22-3	45-6-80
2-D313	ED704547	Diode KBPC802	DS1-00034
2-VR101	EV704510	Semi-fixed/Vol. EVN-K4A 1kB	T4-8297
2-R133	ER704556	Metal Oxide Film/R. 3W 0.33 ohm	T4-28970
2-R134	ER704557	Metal Oxide Film/R. 2W 4.7 ohms	RM2-33047S
2-R139	ER558213	Metal Oxide Film/R. 1W 180 ohm(J)	35-15-10
2-R307,308	ER453565	Metal Oxide Film/R. 2W 1.2K (J)	35-15-8
2-R310	ER490814	Metal Oxide Film/R. 2W 680 ohm(J)	35-15-8
2-R311	ER704555	Fuse/R. 1/4W 100 ohms	RV2-24101
2-R313	ER551621	Carbon/R. RD1/2 150 ohm(J)	35-9-15
2-C308,309	EC310846	Elect/C. (Vert.) 4700μF(M) 35WV	24-12-37
2-F1,2	EF704515	△ Fuse 3.5A 250V (U/T)	T4-28986
2-F1,2	EF704516	△ Fuse 3.5A 250V UL CSA (CSA)	T4-28987
2-F1,2	EF704517	△ Fuse T3.5A 250V (CEE, UK, SAA)	T4-28988
2-F3	EF704512	△ Fuse 0.8A 250V (U/T)	T4-8840
2-F3	EF704513	△ Fuse 0.8A 250VSS-2 UL CSA (CSA)	T4-18172
2-F3	EF704514	△ Fuse T0.8A 250V CEE(CEE, UK, SAA)	T4-8480
2-F4,5	EF704519	△ Fuse 2.5A 250V (U/T)	T4-28989
2-F4,5	EF704521	△ Fuse 3.0A 250V UL CSA (CSA)	T4-38137
2-F4,5	EF704522	△ Fuse T1.6A 250V (CEE, UK, SAA)	T4-18928

3. ASSEMBLY BLOCK

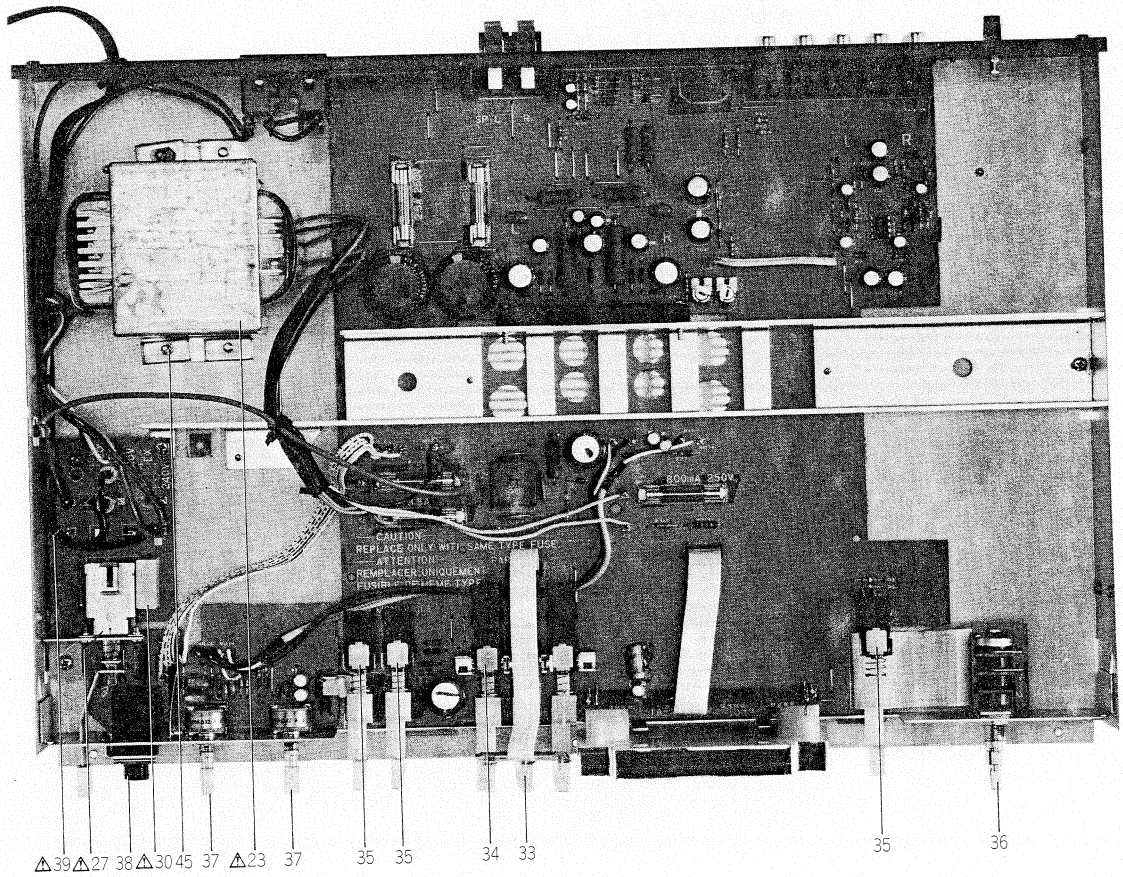
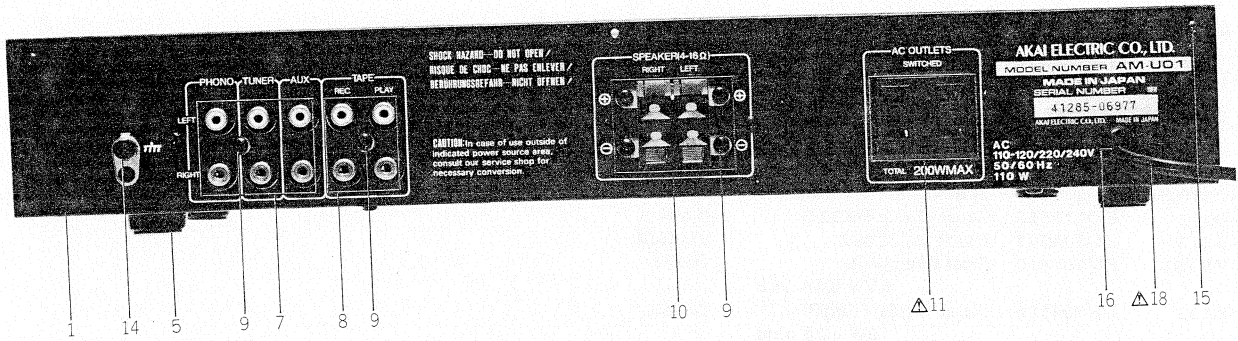

ASSEMBLY BLOCK

Ref. No.	Parts No.	Description	Schematic No.
3-1	SP704493	Rear Panel AM-U01(U/T)(U/T)	T2-2202
3-2x	SP704491	Rear Panel AM-U01(CEE) (CEE)	T2-2200
3-3x	SP704494	Rear Panel AM-U01 (CSA, UL) (CSA)	T2-2203
3-4x	SP704492	Rear Panel AM-U01 (UK) (UK, SAA)	T2-2201
3-5	SA704495	Foot AM-U01	T4-15870
3-6x	ZS447840	Tapping Screw, #2 BR 3x8	
3-7	EJ704499	Pin Jack 6P RCA1796P269	T4-28960
3-8	EJ704500	Pin Jack 4P RCA1794P268	T4-28961
3-9	ZS463353	Tapping Screw, #2 BR 3x8 (Black)	
3-10	EJ704506	SP Jack 4P S-Q2367	T4-28968
3-11	EJ704536	△ AC Outlet UL (U/T)	T4-28976
3-12x	EJ704537	△ AC Outlet (CSA) (CSA)	T4-38099
3-13x	EJ704511	Din Jack 5P 2-01-0128-20 (CEE, UK, SAA)	T4-28975
3-14	EJ704535	GND Terminal	T4-14474
3-15	ZSS89511	Tapping Screw, #2 bind 3x6	
3-16	EJ704538	Cord Bush SR 3P-4 (U/T, CSA)	T4-18125
3-17x	EZ722790	Cord Bushing 4N-4 CS-705DD (CEE, UK, SAA)	T4-10595
3-18	EW704531	△ Power Cord KP-205A VFF (U/T) (U/T)	T4-28981
3-19x	EW704532	△ Power Cord KP-10 SPT-1 (UL, CSA) (CSA)	T4-28982
3-20x	EW704533	△ Power Cord KP-419C LTCE2F (CEE) (CEE)	T4-28983
3-21x	EW704534	△ Power Cord GTBS-2F (UK)	T4-28984
3-22x	EW704554	△ Power Cord KP-560 LTSA-2 SAA (SAA)	T4-28985
3-23	BT704527	△ Power Trans. PT-376 (U/T) (U/T)	T4-28977
3-24x	BT704528	△ Power Trans. PT-376 (UL, CSA) (CSA)	T4-28978
3-25x	BT704529	△ Power Trans. PT-376 (CEE) (CEE)	T4-28979
3-26x	BT704530	△ Power Trans. PT-376 (UK) (UK, SAA)	T4-28980
3-27	ES310839	△ Push SW. SDG1P-E 5A/80A 250V (U/T)	25-5-310
3-28x	ES665875	△ Push SW. SDG1P-J TV-3 UL/CSA (CSA)	25-5-199
3-29x	ES665807	△ Push SW. SDG5P-E 5A/80A 250V (CEE, UK, SAA)	25-5-182
3-30	ER704523	△ Spark Killer CR-3 (U/T)	T4-8445
3-31x	ER704525	△ Spark Killer ECQ-U1A 103ME (CSA)	T4-38043
3-32x	ER704526	△ Spark Killer 0.01μF PME265MB51 (CEE,UK,SAA)	T4-38130
3-33	ED704548	LED SLP-241D-01	DL1-00022
3-34	ES704501	Push SW. R215420	T4-28962
3-35	ES704502	Push SW. R215418	T4-28964
3-36	EV704503	Double-Axial 4-Throw/Vol. 250kBx2 250kAx2	T4-28965
3-37	EV704504	Single-Axial 2-Throw/Vol. 100kAx2	T4-28966
3-38	EJ704505	Headphone Jack S-G2305	T4-28967
3-39	EJ704539	△ Voltage Change Wire (U/T)	NO.10
3-40x	ZS490228	Tapping Screw, #2 bind 3x8	
3-41x	ZS472274	Tapping Screw, #2 bind 3x6	
3-42x	ZS462802	Tapping Screw, #2 BR 3x15	
3-43x	ZS325495	Tapping Screw, #2 BR 3x6	

4. FINAL ASSEMBLY BLOCK

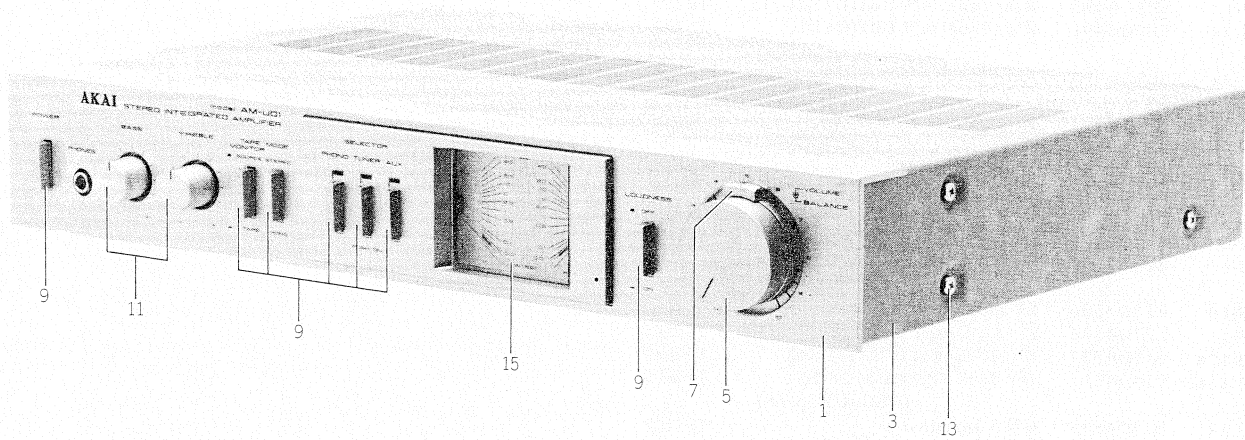

FINAL ASSEMBLY BLOCK

Ref. No.	Parts No.	Description	Schematic No.
4-1	SP704487	Front Panel AM-U01	T2-2199S
4-2x	SP704488	Front Panel (BL) AM-U01	T2-2199B
4-3	SP704489	Upper Cover AM-U01	T2-2145S
4-4x	SP704490	Upper Cover (BL) AM-U01	T2-2145B
4-5	SK704550	Double Knob (Upper) AM-U01	T4-19559S
4-6x	SK704549	Double Knob (Upper-BL) AM-U01	T4-19559B
4-7	SK704552	Double Knob (Lower) AM-U01	T4-19558S
4-8x	SK704551	Double Knob (Lower-BL) AM-U01-BL	T4-19558B
4-9	SB316498	Button (B)	CU-6009
4-10x	SB316499	Button (B-BL)	CU-6009
4-11	SK704541	Single Knob (BL) AM-U01	T4-19562S
4-12x	SK704540	Single Knob (BL) AM-U01	T4-19562B
4-13	ZS322570	S-Tight Screw, bind 4x8	
4-14x	ZS322580	S-Tight Screw, bind 4x8	
4-15	EM704508	Meter MG-108U	T4-28969
4-16x	EM704509	Meter (BL) MG-108U	T4-38096
4-17x	ZS472274	Tapping Screw, #2 bind 3x6	
4-18x	ZW432753	Washer (PBP) D3.1x8x0.2t	

When ordering parts, please quote Parts Number, Description and Model Number.

INDEX

Parts No.	Ref. No. & Symbol No.	Parts No.	Ref. No. & Symbol No.	Parts No.	Ref. No. & Symbol No.	Parts No.	Ref. No. & Symbol No.	Parts No.	Ref. No. & Symbol No.
BT704527	3-23	ZS447840	3-6x						
BT704528	3-24x	ZS462802	3-42x						
BT704529	3-25x	ZS463353	3-9						
BT704530	3-26x	ZS472274	3-41x						
EC310846	2-C308,309	ZS472274	4-17x						
ED237960	2-D310,311	ZS490228	3-40x						
ED313623	2-D312	ZS589511	3-15						
ED379855	2-D101,102	ZW432753	4-18x						
ED624903	2-D103								
ED624903	2-D305								
ED704547	2-D313								
ED704548	3-33								
EF704512	2-F3								
EF704513	2-F3								
EF704514	2-F3								
EF704515	2-F1,2								
EF704516	2-F1,2								
EF704517	2-F1,2								
EF704519	2-F4,5								
EF704521	2-F4,5								
EF704522	2-F4,5								
EI704497	2-IC1								
EI704498	2-IC2								
EJ704499	3-7								
EJ704500	3-8								
EJ704505	3-38								
EJ704506	3-10								
EJ704511	3-13x								
EJ704535	3-14								
EJ704536	3-11								
EJ704537	3-12x								
EJ704538	3-16								
EJ704539	3-39								
EM704508	4-15								
EM704509	4-16x								
ER453565	2-R307,308								
ER490814	2-R310								
ER551621	2-R313								
ER558213	2-R139								
ER704523	3-30								
ER704525	3-31x								
ER704526	3-32x								
ER704555	2-R311								
ER704556	2-R133								
ER704557	2-R134								
ES310839	3-27								
ES665807	3-29x								
ES665875	3-28x								
ES704501	3-34								
ES704502	3-35								
ET223446	2-TR101								
EV704503	3-36								
EV704504	3-37								
EV704510	2-VR101								
EW704531	3-18								
EW704532	3-19x								
EW704533	3-20x								
EW704534	3-21x								
EW704554	3-22x								
EZ722790	3-17x								
SA704495	3-5								
SB316498	4-9								
SB316499	4-10x								
SK704540	4-12x								
SK704541	4-11								
SK704549	4-6x								
SK704550	4-5								
SK704551	4-8x								
SK704552	4-7								
SP704487	4-1								
SP704488	4-2x								
SP704489	4-3								
SP704490	4-4x								
SP704491	3-2x								
SP704492	3-4x								
SP704493	3-1								
SP704494	3-3x								
ZS322570	4-13								
ZS322580	4-14x								
ZS325495	3-43x								

SECTION 3

SCHEMATIC DIAGRAM

1. SCHEMATIC DIAGRAM OF ICs
2. AM-U01 NO. 1600244A SCHEMATIC DIAGRAM

AN6552

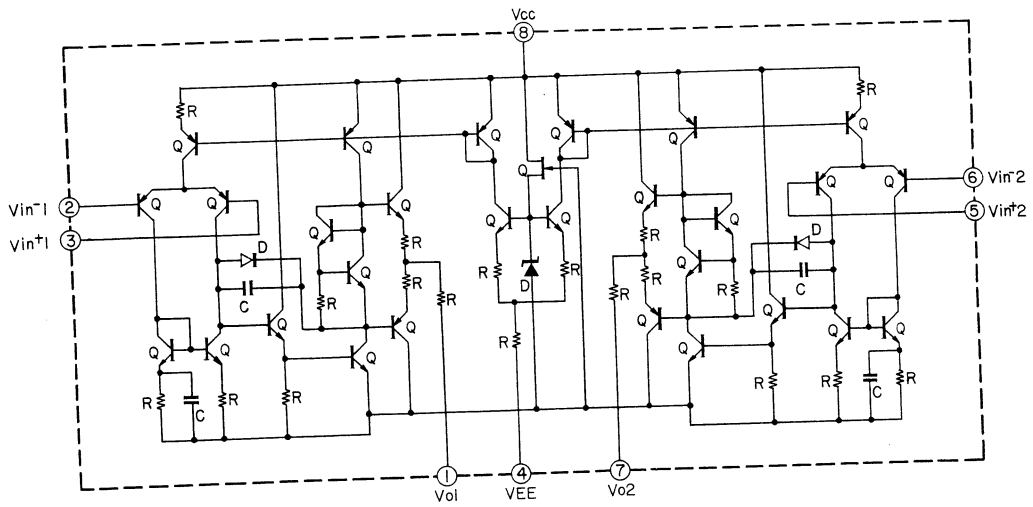

STK461

