



AKAI

DVD PLAYER

Model:
A-4182
A-4183

SERVICE MANUAL

www.akai.ru



SERVICE MANUAL

1. The System Block Diagram&the Block's Function Description
2. Schematic Circuit Diagram
3. Critical Components List
4. IC Date Sheet&IC Description
5. Service Tools and Equipment

1. The System Block Diagram & the Block's Function Description

DVD System Block

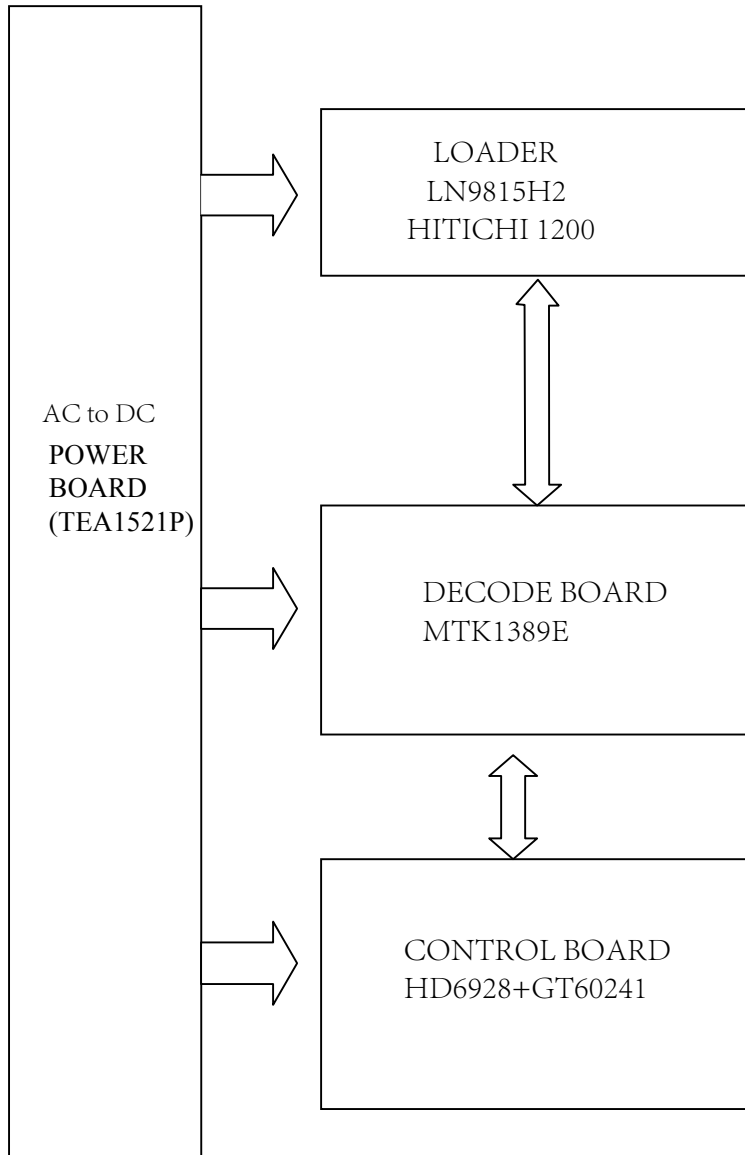

2. Schematic Circuit Diagram

[1,2,4]	VCC	>>	VCC
[1,2,3]	DV33	>>	DV33
[1,2,3,4]	GND	>>	GND
[2]	AL	>>	AL
[2]	AR	>>	AR
[2]	ALS	>>	ALS
[2]	ARS	>>	ARS
[2]	ACENTER	>>	ACENTER
[2]	ASUBW	>>	ASUBW
[2]	MUTE_DAC	>>	MUTE_DAC

ACENTER	CENTER1
ALS	LSUR1
AL	LMAN1
AR	RMAN1
ARS	RSUR1
ASUBW	SUBW1

[2]	MUTE_O	>>	MUTE_O
[2]	OK-POINT	>>	OK-POINT

AKIN1	>>	AKIN1	[2]
AKIN2	>>	AKIN2	[2]
LCH	>>	LCH	[4]
RCH	>>	RCH	[4]
LSCH	>>	LSCH	[4]
RSCH	>>	RSCH	[4]
CENT	>>	CENT	[4]
SUB	>>	SUB	[4]

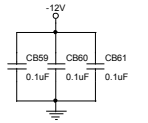
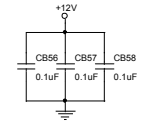
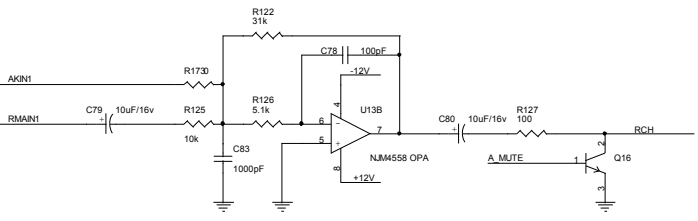
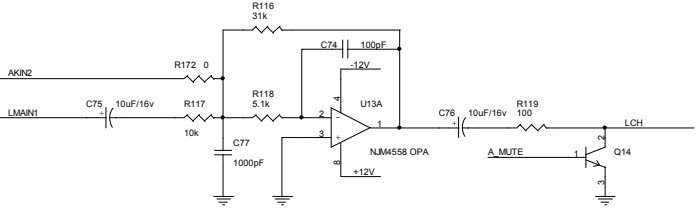
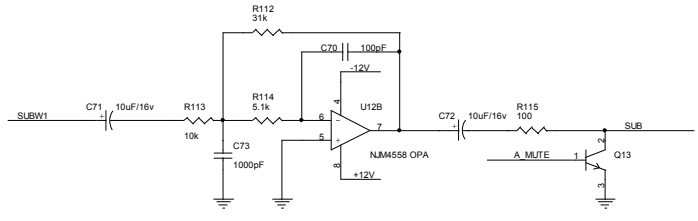
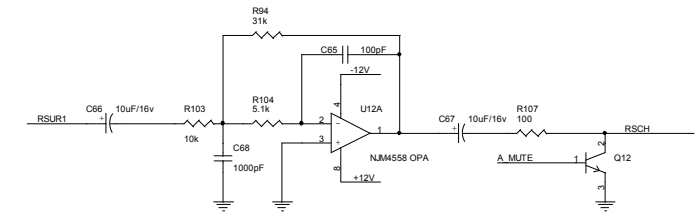
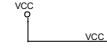

MUTE

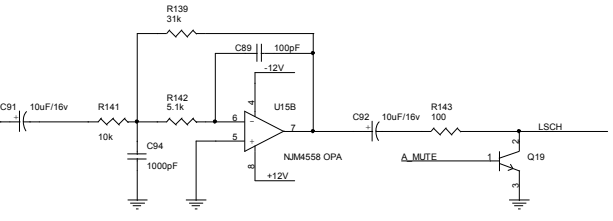
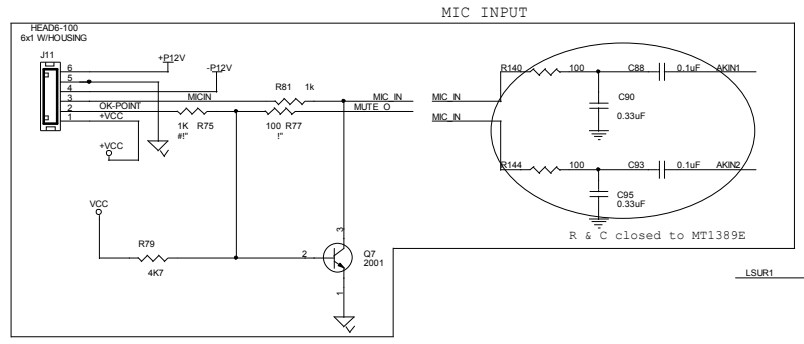

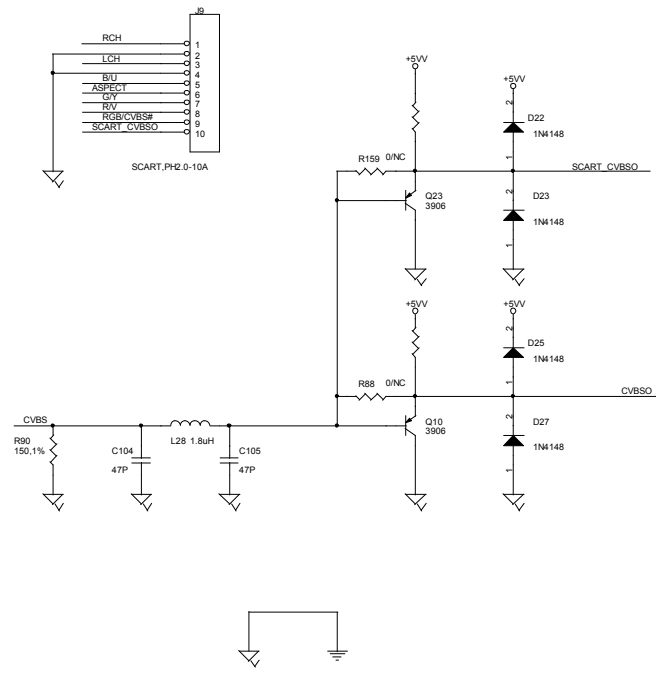
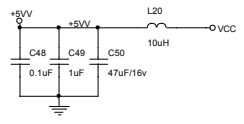
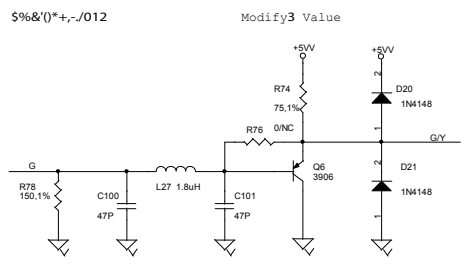
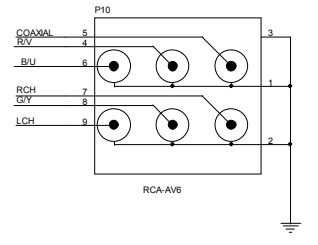
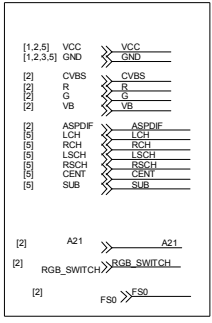

Note: Video is the high resistance output

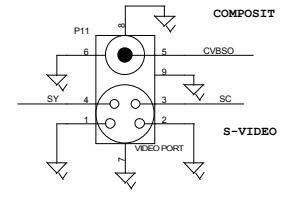
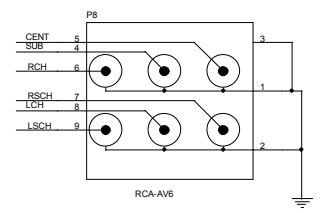
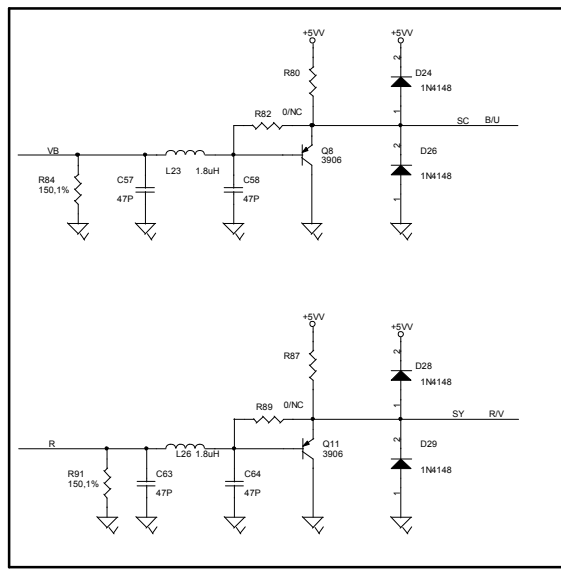

COMPOSIT
S-VIDEO

[1,2,5] DV33
[1,2,4,5] GND

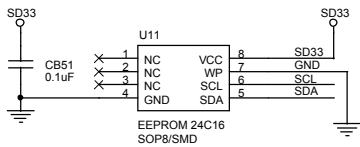
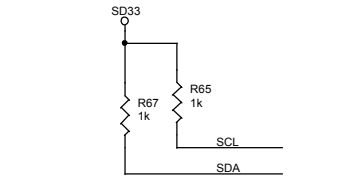
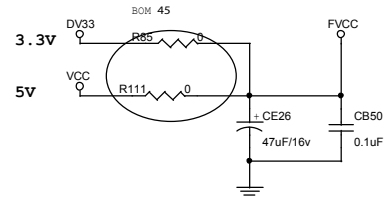
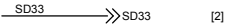
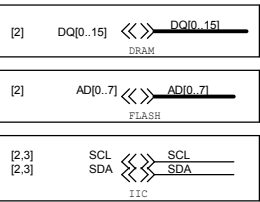
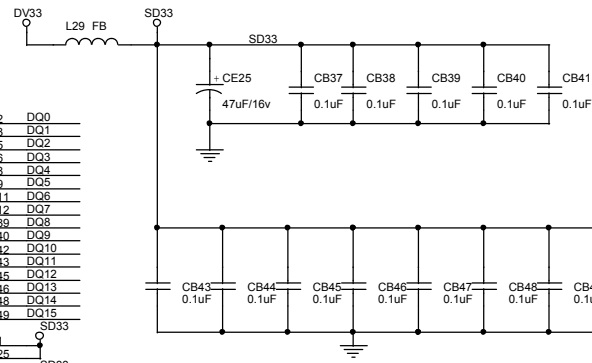
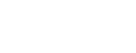
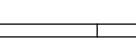
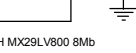
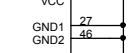
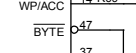
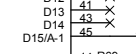
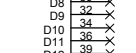
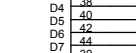
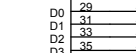
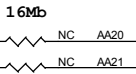
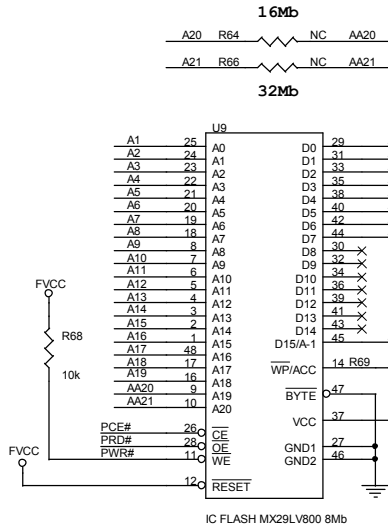
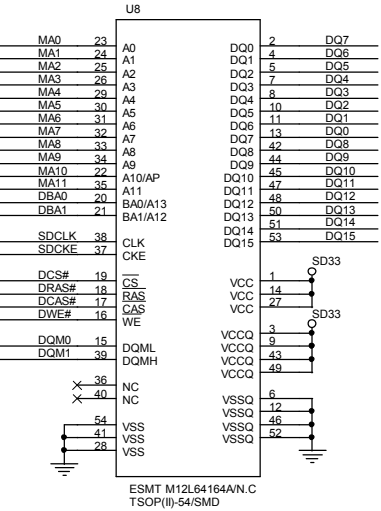
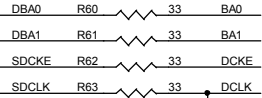
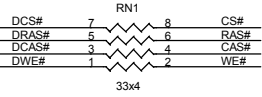
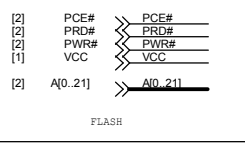
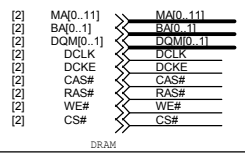

ESMT M12L16161A-7

16Mb

32Mb

IC FLASH MX29LV800 8Mb

EEPROM 24C16 SOP8/SMD

ESMT M12L64164AN.C TSOP(II)-54/SMD

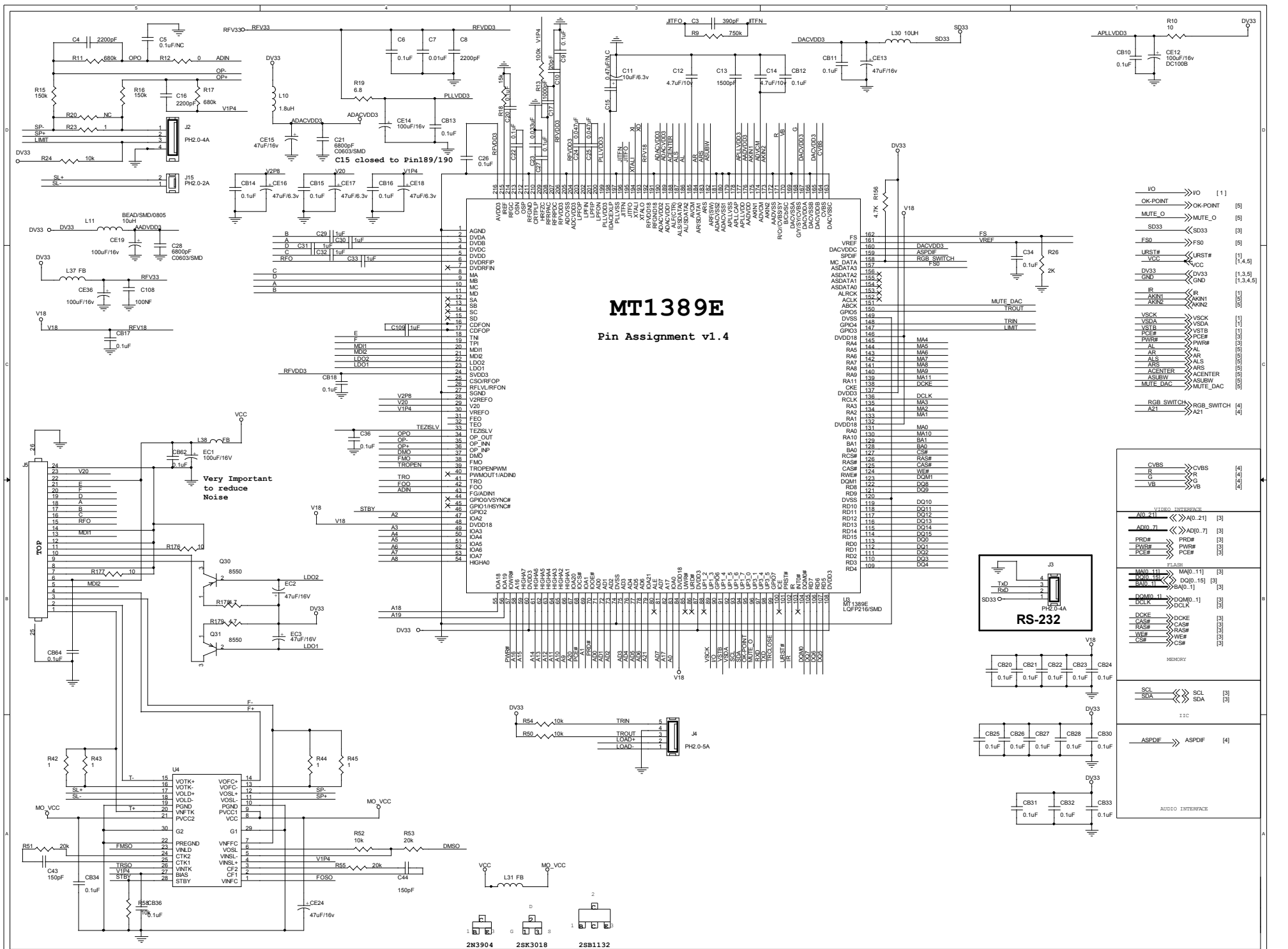

MT1389E

Pin Assignment v1.4

AVDD3	1	AGND	1
DVDD3	2	DVDD3	2
FS	3	FS	3
DACVDD3	4	DACVDD3	4
VREF	5	VREF	5
MC_DATA	6	MC_DATA	6
ASDATA3	7	ASDATA3	7
ASDATA2	8	ASDATA2	8
ASDATA1	9	ASDATA1	9
ASDATA0	10	ASDATA0	10
ALRCK	11	ALRCK	11
ACLK	12	ACLK	12
ABCK	13	ABCK	13
GPDS	14	GPDS	14
DVSS	15	DVSS	15
GPDS	16	GPDS	16
GPDS	17	GPDS	17
DVDD18	18	DVDD18	18
RA4	19	MA4	19
RA5	20	MA5	20
RA6	21	MA6	21
RA7	22	MA7	22
RA8	23	MA8	23
RA9	24	MA9	24
RA11	25	MA11	25
CHE	26	DCKE	26
DVDD3	27	DVDD3	27
RCLK	28	DCLK	28
RA3	29	MA3	29
RA2	30	MA2	30
RA1	31	MA1	31
DVDD18	32	DVDD18	32
RA0	33	MA0	33
RA10	34	MA10	34
BA1	35	BA1	35
BA0	36	BA0	36
RCM	37	CS#	37
RA5#	38	CAS#	38
CAS#	39	WE#	39
RWS#	40	RAS#	40
DM1	41	DM1	41
DM0	42	DM0	42
DM9	43	DM9	43
DVSS	44	DO10	44
RD10	45	DO11	45
RD11	46	DO12	46
RD12	47	DO13	47
RD13	48	DO14	48
RD14	49	DO15	49
RD15	50	DO16	50
RD0	51	DO1	51
RD1	52	DO2	52
RD2	53	DO3	53
RD3	54	DO4	54
RD4	55	DO5	55
DA18	56	DA18	56
DVDD3	57	DVDD3	57
DVDD3	58	DVDD3	58
DVDD3	59	DVDD3	59
DVDD3	60	DVDD3	60
DVDD3	61	DVDD3	61
DVDD3	62	DVDD3	62
DVDD3	63	DVDD3	63
DVDD3	64	DVDD3	64
DVDD3	65	DVDD3	65
DVDD3	66	DVDD3	66
DVDD3	67	DVDD3	67
DVDD3	68	DVDD3	68
DVDD3	69	DVDD3	69
DVDD3	70	DVDD3	70
DVDD3	71	DVDD3	71
DVDD3	72	DVDD3	72
DVDD3	73	DVDD3	73
DVDD3	74	DVDD3	74
DVDD3	75	DVDD3	75
DVDD3	76	DVDD3	76
DVDD3	77	DVDD3	77
DVDD3	78	DVDD3	78
DVDD3	79	DVDD3	79
DVDD3	80	DVDD3	80
DVDD3	81	DVDD3	81
DVDD3	82	DVDD3	82
DVDD3	83	DVDD3	83
DVDD3	84	DVDD3	84
DVDD3	85	DVDD3	85
DVDD3	86	DVDD3	86
DVDD3	87	DVDD3	87
DVDD3	88	DVDD3	88
DVDD3	89	DVDD3	89
DVDD3	90	DVDD3	90
DVDD3	91	DVDD3	91
DVDD3	92	DVDD3	92
DVDD3	93	DVDD3	93
DVDD3	94	DVDD3	94
DVDD3	95	DVDD3	95
DVDD3	96	DVDD3	96
DVDD3	97	DVDD3	97
DVDD3	98	DVDD3	98
DVDD3	99	DVDD3	99
DVDD3	100	DVDD3	100

IO	>>> IO	[1]
OK-POINT	>>> OK-POINT	[5]
MUTE_O	>>> MUTE_O	[5]
SD33	>>> SD33	[3]
FS0	>>> FS0	[1]
LRST#	>>> LRST#	[1, 4, 5]
VCC	>>> VCC	[1, 3, 4, 5]
DV33	>>> DV33	[1, 3, 4, 5]
GND	>>> GND	[1, 3, 4, 5]
IR	>>> IR	[1]
AKN1	>>> AKN1	[1]
AKN2	>>> AKN2	[5]
V5CK	>>> V5CK	[1]
V5DA	>>> V5DA	[1]
V5TB	>>> V5TB	[1]
PCF#	>>> PCF#	[3]
PWR#	>>> PWR#	[3]
AL	>>> AL	[5]
AR	>>> AR	[5]
ALS	>>> ALS	[5]
ARS	>>> ARS	[5]
ACENTER	>>> ACENTER	[5]
ASUBW	>>> ASUBW	[5]
MUTE_DAC	>>> MUTE_DAC	[5]
RGB_SWITCH	>>> RGB_SWITCH	[4]
AZ1	>>> AZ1	[4]
CVBS	>>> CVBS	[4]
R	>>> R	[4]
G	>>> G	[4]
B	>>> B	[4]
VB	>>> VB	[4]
AD0_21[1]	>>> AD0..21	[3]
AD0_7[1]	>>> AD0..7	[3]
PRD#	>>> PRD#	[3]
PRD#	>>> PRD#	[3]
PCE#	>>> PCE#	[3]
MA0_11[1]	>>> MA0..11	[3]
MA0_15[1]	>>> MA0..15	[3]
BA0_1[1]	>>> BA0..1	[3]
DM0_11[1]	>>> DM0..11	[3]
DCLK	>>> DCLK	[3]
DCKE	>>> DCKE	[3]
CAS#	>>> CAS#	[3]
RAS#	>>> RAS#	[3]
WE#	>>> WE#	[3]
CS#	>>> CS#	[3]
SCL	>>> SCL	[3]
SNA	>>> SCL SNA	[3]
ASPDF	>>> ASPDF	[4]

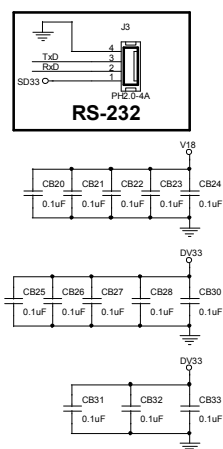

COMMON1389E_HD60_V3

MT1389E (LQFP216) DVD MP Board for SANYO HD60 PUH

- 1 INDEX & POWER, RESET
- 2 MT1389E
- 3 SDRAM & FLASH
- 4 VIDEO OUT & AV-CON
- 5 AUDIO OUT - WM8766

Rev	History	P#	Date
V1	Initial released. Modified from 3-SY1389DP1-V11		2005.01.19
V2	Add SCART and VGA output		2005.03.01
V3	Modify Video backend circuit.		2005.03.09

NAME	TYPE	DEVICE
VCC	Digital 5V	SUPPLY
DV33	Digital 3.3V	MT1389E
RFV33	Servo 3.3V	MT1389E
AV33	Laser Diode 3.3V	
V18	Digital 1.8V	MT1389E
SD33	Digital 3.3V	SDRAM
+12V	Audio +12V	OP AMP.
-12V	Audio -12V	OP AMP.
AVDD5	Audio 5V	Audio DAC
DVDD3	Audio 3.3V	Audio DAC

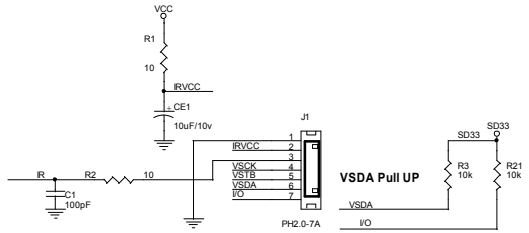

Open IR1, if used VFD

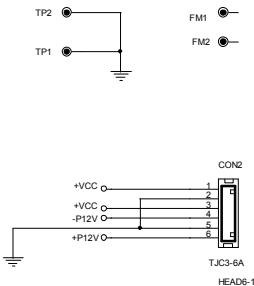
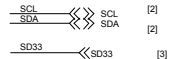
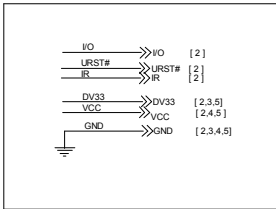

Reserved for testing

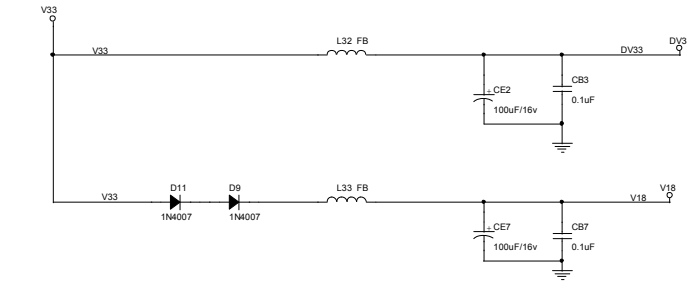
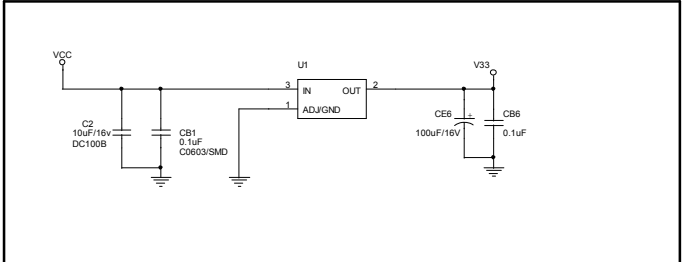

RESET Circuit

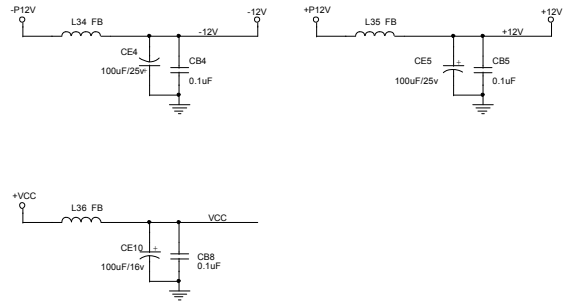
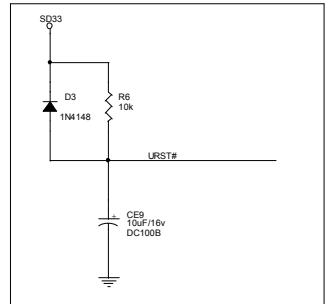

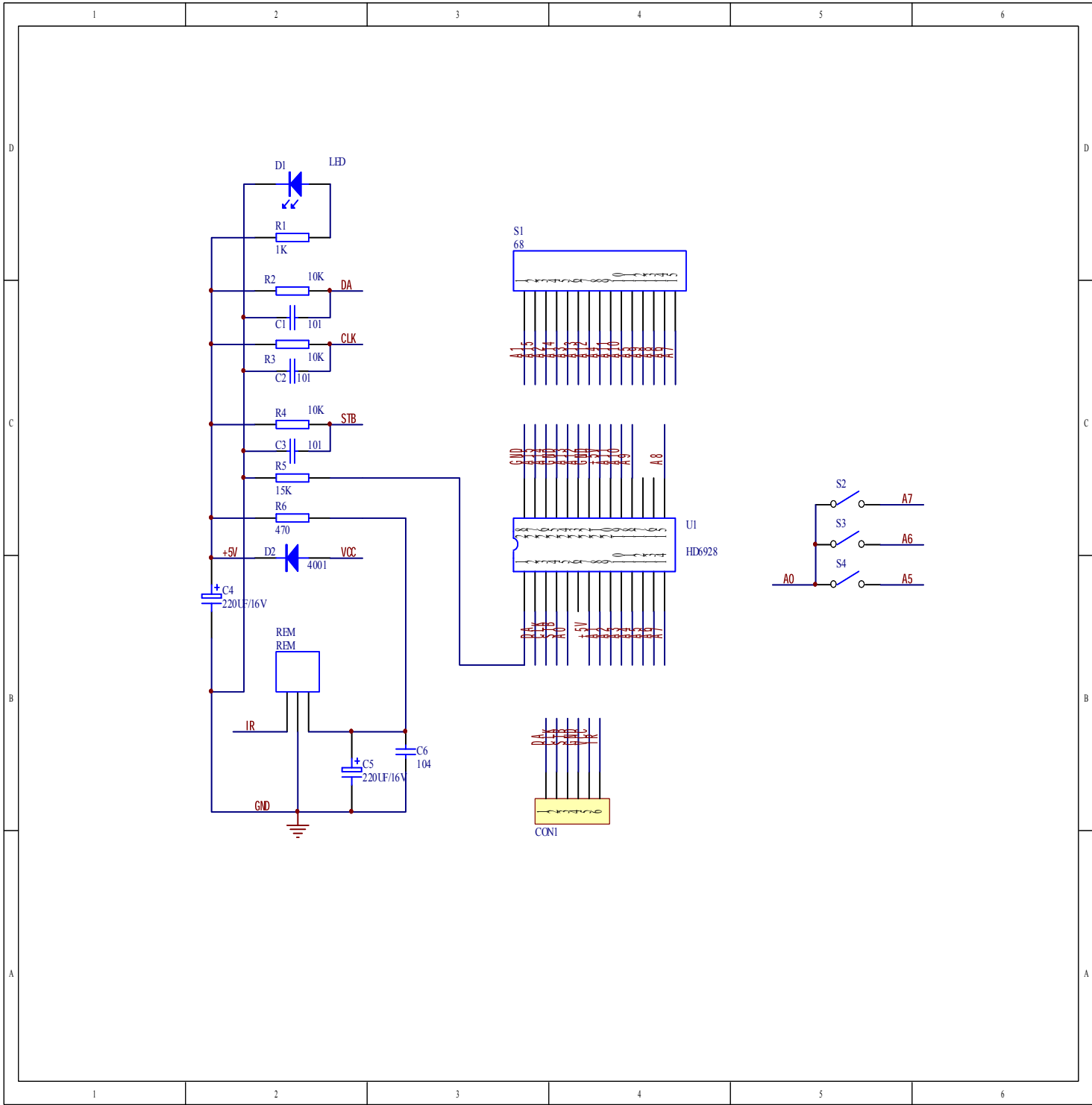

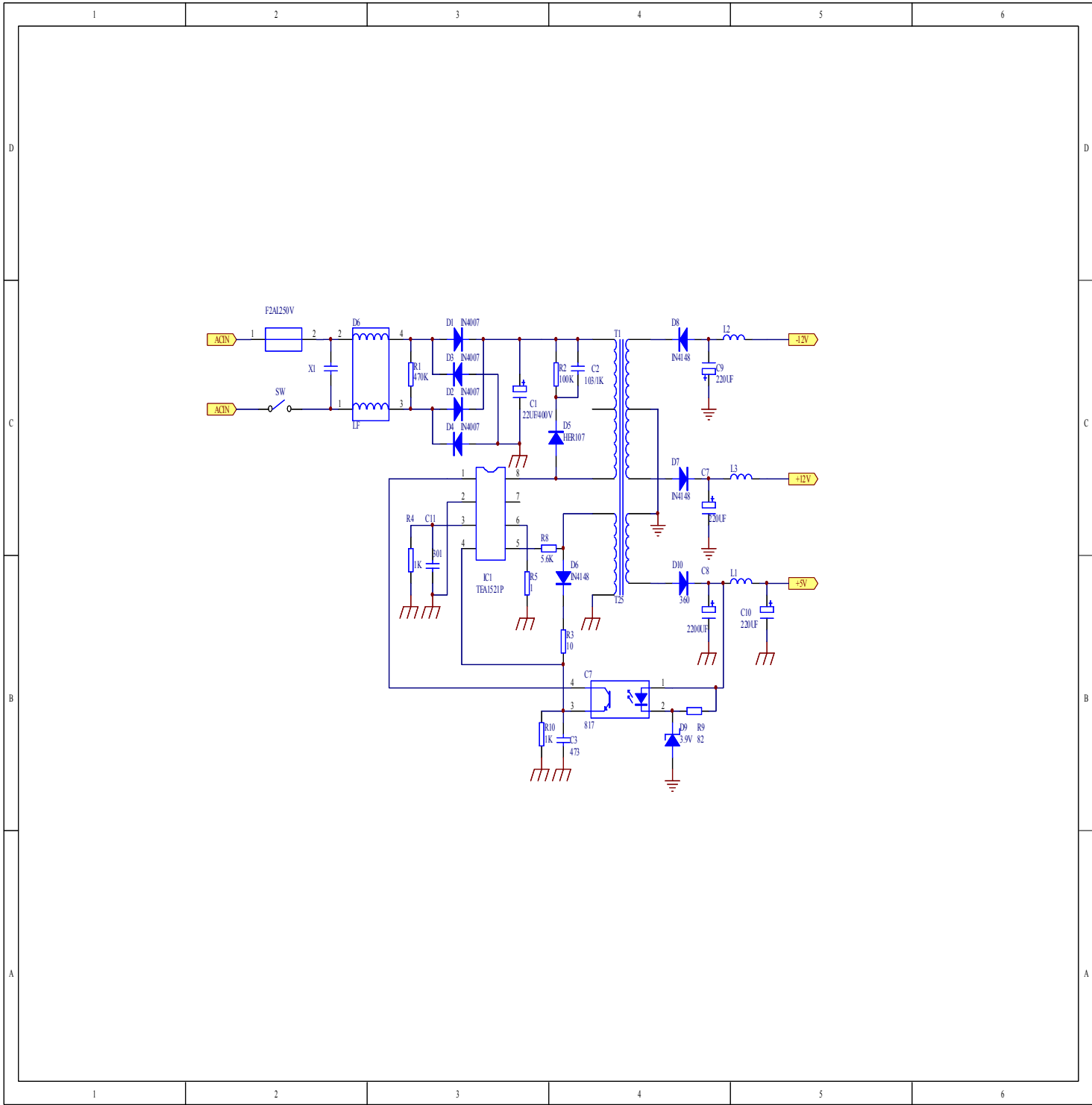

3.Critical Components List

Singing	Appellation
S29AL008070TF102	IC
V36V1616100TC-7	IC
D5888S	IC
MT1389DE-E	IC
TEA1521P	IC
HD6928	IC
GT-60241	DISPLAY

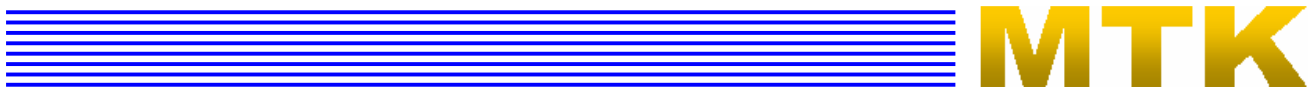

Version 1.5

MT1389E
Pin Assignment

Specifications are subject to change without notice

Abbreviations:

- SR: Slew Rate
- PU: Pull Up
- PD: Pull Down
- SMT: Schmitt Trigger
- 4mA~16mA: Output buffer driving strength.

Pin	Main	Alt.	Type	Description
RF Interface (26)				
191	RFGND18		Ground	Analog ground
192	RFVDD18		Power	Analog power 1.8V
212	OSP		Analog output	RF Offset cancellation capacitor connecting
213	OSN		Analog output	RF Offset cancellation capacitor connecting
214	RFGC		Analog output	RF AGC loop capacitor connecting for DVD-ROM
215	IREF		Analog Input	Current reference input. It generates reference current for RF path. Connect an external 15K resistor to this pin and AVSS
216	AVDD3		Power	Analog power 3.3V
1	AGND		Ground	Analog ground
2	DVDA		Analog Input	AC coupled input path A
3	DVDB		Analog Input	AC coupled input path B
4	DVDC		Analog Input	AC coupled input path C
5	DVDD		Analog Input	AC coupled input path D
6	DVDRFIP		Analog Input	AC coupled DVD RF signal input RFIP
7	DVDRFIN		Analog Input	AC coupled DVD RF signal input RFIN
8	MA		Analog Input	DC coupled main-beam RF signal input A
9	MB		Analog Input	DC coupled main-beam RF signal input B
10	MC		Analog Input	DC coupled main-beam RF signal input C
11	MD		Analog Input	DC coupled main-beam RF signal input D
12	SA		Analog Input	DC coupled sub-beam RF signal input A
13	SB		Analog Input	DC coupled sub-beam RF signal input B
14	SC		Analog Input	DC coupled sub-beam RF signal input C
15	SD		Analog Input	DC coupled sub-beam RF signal input D
16	CDFON		Analog Input	CD focusing error negative input
17	CDFOP		Analog Input	CD focusing error positive input
18	TNI		Analog Input	3 beam satellite PD signal negative input
19	TPI		Analog Input	3 beam satellite PD signal positive input
ALPC (4)				
20	MDI1		Analog Input	Laser power monitor input



Pin	Main	Alt.	Type	Description
21	MDI2		Analog Input	Laser power monitor input
22	LDO2		Analog Output	Laser driver output
23	LDO1		Analog Output	Laser driver output
Reference Voltage (3)				
28	V2REFO		Analog output	Reference voltage 2.8V
29	V20		Analog output	Reference voltage 2.0V
30	VREFO		Analog output	Reference voltage 1.4V
Analog Monitor Output (7)				
24	SVDD3		Power	Analog power 3.3V
25	CSO	RFOP	Analog output	1) Central servo 2) Positive main beam summing output
26	RFLVL	RFON	Analog output	1) RFRP low pass, or 2) Negative main beam summing output
27	SGND		Ground	Analog ground
31	FEO		Analog output	Focus error monitor output
32	TEO		Analog output	Tracking error monitor output
33	TEZISLV		Analog output	TE slicing Level
Analog Servo Interface (8)				
204	ADCVDD3		Power	Analog 3.3V power for ADC
205	ADCVSS		Ground	Analog ground for ADC
206	RFVDD3		Power	Analog power
207	RFRPDC		Analog output	RF ripple detect output
208	RFRPAC		Analog Input	RF ripple detect input (through AC-coupling)
209	HRFZC		Analog Input	High frequency RF ripple zero crossing
210	CRTPLP		Analog output	Defect level filter capacitor connecting
211	RFGND		Ground	Analog Power
RF Data PLL Interface (9)				
195	JITFO		Analog output	Output terminal of RF jitter meter
196	JITFN		Analog Input	Input terminal of RF jitter meter
197	PLLVSS		Ground	Ground pin for data PLL and related analog circuitry
198	IDACEXP		Analog output	Data PLL DAC Low-pass filter
199	PLLVDD3		Power	Power pin for data PLL and related analog circuitry
200	LPFON		Analog Output	Negative output of loop filter amplifier
201	LPFIP		Analog Input	Positive input terminal of loop filter amplifier
202	LPFIN		Analog Input	Negative input terminal of loop filter amplifier
203	LPFOP		Analog Output	Positive output of loop filter amplifier
Motor and Actuator Driver Interface (10)				



Pin	Main	Alt.	Type	Description
34	OP_OUT		Analog output	Op amp output
35	OP_INN		Analog input	Op amp negative input
36	OP_INP		Analog input	Op amp positive input
37	DMO		Analog Output	Disk motor control output. PWM output
38	FMO		Analog Output	Feed motor control. PWM output
39	TROPENPWM		Analog Output	Tray PWM output/Tray open output
40	PWMOUT1	ADIN0	Analog Output	1) 1 st General PWM output 2) AD input 0
41	TRO		Analog Output	Tracking servo output. PDM output of tracking servo compensator
42	FOO		Analog Output	Focus servo output. PDM output of focus servo compensator
43	FG (Digital pin)	ADIN1 GPIO	LVTTTL 3.3V Input, Schmitt Input, pull up, with analog input path for ADIN1	1) Motor Hall sensor input 2) AD input 1 3) GPIO
General Power/Ground (11)				
48,84, 132, 146	DVDD18		Power	1.8V power pin for internal digital circuitry
74, 120	DVSS		Ground	1.8V Ground pin for internal digital circuitry
60,87, 108,137	DVDD3		Power	3.3V power pin for internal digital circuitry
149	DVSS		Ground	3.3V Ground pin for internal digital circuitry
Micro Controller and Flash Interface (48)				
54	HIGHA0		InOut 4~16mA, SR PU	Microcontroller address 8
66	HIGHA1		InOut 4~16mA, SR PU	Microcontroller address 9
65	HIGHA2		InOut 4~16mA, SR PU	Microcontroller address 10
64	HIGHA3		InOut 4~16mA, SR PU	Microcontroller address 11
63	HIGHA4		InOut 4~16mA, SR PU	Microcontroller address 12
62	HIGHA5		InOut 4~16mA, SR PU	Microcontroller address 13
61	HIGHA6		InOut 4~16mA, SR PU	Microcontroller address 14



Pin	Main	Alt.	Type	Description
59	HIGHA7		InOut 4~16mA, SR PU	Microcontroller address 15
81	AD7		InOut 4~16mA, SR	Microcontroller address/data 7
78	AD6		InOut 4~16mA, SR	Microcontroller address/data 6
77	AD5		InOut 4~16mA, SR	Microcontroller address/data 5
76	AD4		InOut 4~16mA, SR	Microcontroller address/data 4
75	AD3		InOut 4~16mA, SR	Microcontroller address/data 3
73	AD2		InOut 4~16mA, SR	Microcontroller address/data 2
72	AD1		InOut 4~16mA, SR	Microcontroller address/data 1
71	AD0		InOut 4~16mA, SR	Microcontroller address/data 0
83	IOA0		InOut 4~16mA, SR PU	Microcontroller address 0 / IO
69	IOA1		InOut 4~16mA, SR PU	Microcontroller address 1 / IO
47	IOA2		InOut 4~16mA, SR PU	Microcontroller address 2 / IO
49	IOA3		InOut 4~16mA, SR PU	Microcontroller address 3 / IO
50	IOA4		InOut 4~16mA, SR PU	Microcontroller address 4 / IO
51	IOA5		InOut 4~16mA, SR PU	Microcontroller address 5 / IO
52	IOA6		InOut 4~16mA, SR PU	Microcontroller address 6 / IO
53	IOA7		InOut 4~16mA, SR PU	Microcontroller address 7 / IO
58	A16		Output 4~16mA, SR PU	Flash address 16



Pin	Main	Alt.	Type	Description
82	A17		Output 4~16mA, SR PU	Flash address 17
55	IOA18		InOut 4~16mA, SR PD, SMT	Flash address 18 / IO
56	IOA19		InOut 4~16mA, SR PD, SMT	Flash address 19 / IO
67	IOA20	YUV0	InOut 4~16mA, SR PD, SMT	1) Flash address 20 / IO 2) While External Flash size <= 1MB: I) Alternate digital video YUV output 0
79	IOA21	YUV7 GPIO	InOut 4~16mA, SR PD, SMT	1) Flash address 21 / IO 2) While External Flash size <= 2MB: I) Digital video YUV output 7 II) GPIO
80	ALE		InOut 4~16mA, SR PU, SMT	Microcontroller address latch enable
70	IOOE#		InOut 4~16mA, SR SMT	Flash output enable, active low / IO
57	IOWR#		InOut 4~16mA, SR PU, SMT	Flash write enable, active low / IO
68	IOCS#		InOut 4~16mA, SR SMT	Flash chip select, active low / IO
85	UWR#		InOut 4~16mA, SR PU, SMT	Microcontroller write strobe, active low
86	URD#		InOut 4~16mA, SR PU, SMT	Microcontroller read strobe, active low
88	UP1_2		InOut 4mA, SR PU, SMT	Microcontroller port 1-2
89	UP1_3		InOut 4mA, SR PU, SMT	Microcontroller port 1-3
91	UP1_4		InOut 4mA, SR PU, SMT	Microcontroller port 1-4
92	UP1_5		InOut 4mA, SR PU, SMT	Microcontroller port 1-5



Pin	Main	Alt.	Type	Description
93	UP1_6	SCL	InOut 4mA, SR PU, SMT	1) Microcontroller port 1-6 2) I ² C clock pin
94	UP1_7	SDA	InOut 4mA, SR PU, SMT	1) Microcontroller port 1-7 2) I ² C data pin
95	UP3_0	RXD	InOut 4mA, SR PU, SMT	1) Microcontroller port 3-0 2) 8032 RS232 RxD
96	UP3_1	TXD	InOut 4mA, SR PU, SMT	1) Microcontroller port 3-1 2) 8032 RS232 TxD
97	UP3_4	RXD SCL	InOut 4mA, SR PU, SMT	1) Microcontroller port 3-4 2) Hardwired RD232 RxD 3) I ² C clock pin
98	UP3_5	TXD SDA	InOut 4mA, SR PU, SMT	1) Microcontroller port 3-5 2) Hardwired RD232 TxD 3) I ² C data pin
102	IR		Input SMT	IR control signal input
103	INT0#		InOut 4-16mA, SR PU, SMT	Microcontroller external interrupt 0, active low
Audio interface (28)				
153	ALRCK	YUV1 GPO	InOut 4mA, PD, SMT	1) Audio left/right channel clock 2) Trap value in power-on reset: I) 1: use external 373 II) 0: use internal 373 3) While internal audio DAC used: I) Digital video YUV output 1 II) GPO
151	ABCK	YUV0 GPIO	InOut 4mA	1) Audio bit clock 2) While internal audio DAC used: I) Digital video YUV output 0 II) GPIO
152	ACLK	YUV0 GPIO	InOut 4mA SMT	1) Audio DAC master clock 2) While internal audio DAC used: I) Alternate digital video YUV output 0 II) GPIO



Pin	Main	Alt.	Type	Description
154	ASDATA0	YUV2 GPO	InOut 4mA PD SMT	<ol style="list-style-type: none"> 1) Audio serial data 0 (Front-Left/Front-Right) 2) Trap value in power-on reset: <ol style="list-style-type: none"> I) 1: manufactory test mode II) 0: normal operation 3) While internal audio DAC used: <ol style="list-style-type: none"> I) Digital video YUV output 2 II) GPO
155	ASDATA1	YUV4 GPO	InOut 4mA PD SMT	<ol style="list-style-type: none"> 1) Audio serial data 1 (Left-Surround/Right-Surround) 2) Trap value in power-on reset: <ol style="list-style-type: none"> I) 1: manufactory test mode II) 0: normal operation 3) While only 2 channels output: <ol style="list-style-type: none"> I) Digital video YUV output 4 II) GPO
156	ASDATA2	YUV5 GPO	InOut 4mA PD SMT	<ol style="list-style-type: none"> 1) Audio serial data 2 (Center/LFE) 2) Trap value in power-on reset: <ol style="list-style-type: none"> I) 1: manufactory test mode II) 0: normal operation 3) While only 2 channels output: <ol style="list-style-type: none"> I) Digital video YUV output 5 II) GPO
157	ASDATA3	YUV6 GPIO	InOut 4mA PD SMT	<ol style="list-style-type: none"> 1) Audio serial data 3 (Center-back/ Center-left-back/Center-right-back, in 6.1 or 7.1 mode) 2) While only 2 channels output: <ol style="list-style-type: none"> I) Digital video YUV output 6 II) GPIO
158	MC_DATA	INT2# YUV0 GPIO	InOut 2mA	<ol style="list-style-type: none"> 1) Microphone serial input 2) While not support Microphone: <ol style="list-style-type: none"> I) Microcontroller external interrupt 2 II) Digital video YUV output 0 III) GPIO
159	SPDIF		Output 4~16mA, SR: ON/OFF	S/PDIF output
172	AADVSS		Ground	Ground pin for 2ch audio ADC circuitry
173	AKIN2		Analog	Audio ADC input 2
174	ADVCM		Analog	2ch audio ADC reference voltage
175	AKIN1		Analog	Audio ADC input 1
176	AADVDD		Power	3.3V power pin for 2ch audio ADC circuitry
177	APLLVDD3		Power	3.3V Power pin for audio clock circuitry
178	APLLCAP		Analog InOut	APLL external capacitance connection
179	APLLVSS		Ground	Ground pin for audio clock circuitry
180	ADACVSS2		Ground	Ground pin for audio DAC circuitry
181	ADACVSS1		Ground	Ground pin for audio DAC circuitry
182	ARF	GPIO	Output	<ol style="list-style-type: none"> 1) Audio DAC sub-woofer channel output 2) While internal audio DAC not used: GPIO



Pin	Main	Alt.	Type	Description
183	ARS	GPIO	Output	1) Audio DAC right Surround channel output 2) While internal audio DAC not used: GPIO
184	AR	GPIO	Output	1) Audio DAC right channel output 2) While internal audio DAC not used: a. SDATA1 b. GPIO
185	AVCM		Analog	Audio DAC reference voltage
186	AL	GPIO	Output	1) Audio DAC left channel output 2) While internal audio DAC not used: a. SDATA2 b. GPIO
187	ALS	GPIO	Output	1) Audio DAC left Surround channel output 2) While internal audio DAC not used: a. SDATA0 b. GPIO
188	ALF	GPIO	Output	1) Audio DAC center channel output 2) While internal audio DAC not used: GPIO
189	ADACVDD1		Power	3.3V power pin for audio DAC circuitry
190	ADACVDD2		Power	3.3V power pin for audio DAC circuitry
FOR MTK SZ Video Interface (12)				
160	DACVDDC		Power	3.3V power pin for video DAC circuitry
161	VREF		Analog	Bandgap reference voltage
162	FS		Analog	Full scale adjustment
163	DACVSSC		Ground	Ground pin for video DAC circuitry
164	CVBS		Output 4mA, SR	Analog composite output
165	DACVDDDB		Power	3.3V power pin for video DAC circuitry
166	DACVSSB		Ground	Ground pin for video DAC circuitry
167	DACVDDA		Power	3.3V power pin for video DAC circuitry
168	Y/G		Output 4mA, SR	Green, Y, SY, or CVBS
169	DACVSSA		Ground	Ground pin for video DAC circuitry
170	B/CB/PB		Output 4mA, SR	Blue, CB/PB, or SC
171	R/CR/PR		Output 4mA, SR	Red, CR/PR, CVBS, or SY
MISC (12)				
101	PRST#		Input PU, SMT	Power on reset input, active low
100	ICE		Input PD, SMT	Microcontroller ICE mode enable
193	XTALO		Output	27MHz crystal output



Pin	Main	Alt.	Type	Description
194	XTALI		Input	27MHz crystal input
44	GPIO0	VSYN YUV1	InOut 4mA, SR SMT	1) General purpose IO 0 2) Vertical sync for video input 3) Digital video YUV output 1
45	GPIO1	HSYN INT4# YUV2	InOut 4mA, SR SMT	1) General purpose IO 1 2) Horizontal sync for video input 3) Microcontroller external interrupt 4 4) Digital video YUV output 2
46	GPIO2	SPMCLK	InOut 2mA	1) General purpose IO 2 2) Audio S/PDIF SPMCLK input
147	GPIO3	INT1# SPDATA	InOut 2mA	1) General purpose IO 3 2) Microcontroller external interrupt 1 3) Audio S/PDIF SPDATA input
148	GPIO4	SPLRCK	InOut 2mA	1) General purpose IO 4 2) Audio S/PDIF SPLRCK input
150	GPIO5	INT3# SPBCK	InOut 2mA	1) General purpose IO 5 2) Microcontroller external interrupt 3 3) Audio S/PDIF SPBCK input
90	GPIO6	YUVCLK	InOut 4mA, SR PD, SMT	1) General purpose IO 6 2) Digital video clock output
99	GPIO7	YUV3	InOut 4mA, PD, SMT	1) General purpose IO 7 2) Digital video YUV output 3
Dram Interface (38) (Sorted by position)				
145	RA4		InOut	DRAM address 4
144	RA5		InOut	DRAM address 5
143	RA6		InOut	DRAM address 6
142	RA7		InOut	DRAM address 7
141	RA8		InOut	DRAM address 8
140	RA9		InOut	DRAM address 9
139	RA11		InOut Pull-Down	DRAM address bit 11
138	CKE		Output	DRAM clock enable
136	RCLK		InOut	Dram clock
135	RA3		InOut	DRAM address 3
134	RA2		InOut	DRAM address 2
133	RA1		InOut	DRAM address 1
131	RA0		InOut	DRAM address 0
130	RA10		InOut	DRAM address 10
129	BA1		InOut	DRAM bank address 1
128	BA0		InOut	DRAM bank address 0
127	RCS#		Output	DRAM chip select, active low
126	RAS#		Output	DRAM row address strobe, active low



Pin	Main	Alt.	Type	Description
125	CAS#		Output	DRAM column address strobe, active low
124	RWE#		Output	DRAM Write enable, active low
123	DQM1		InOut	Data mask 1
122	RD8		InOut	DRAM data 8
121	RD9		InOut	DRAM data 9
119	RD10		InOut	DRAM data 10
118	RD11		InOut	DRAM data 11
117	RD12		InOut	DRAM data 12
116	RD13		InOut	DRAM data 13
115	RD14		InOut	DRAM data 14
114	RD15		InOut	DRAM data 15
113	RD0		InOut	DRAM data 0
112	RD1		InOut	DRAM data 1
111	RD2		InOut	DRAM data 2
110	RD3		InOut	DRAM data 3
109	RD4		InOut	DRAM data 4
107	RD5		InOut	DRAM data 5
106	RD6		InOut	DRAM data 6
105	RD7		InOut	DRAM data 7
104	DQM0		InOut	Data mask 0

FOR MTK SZ

Note:

1. The Main column is the main function, Alt. means alternative function.
2. The multi-function GPIO pins are set to **green characters**.
3. The multi-function GPO pins are set to **blue characters**.
4. The external TV encoder mode only supports CCIR-656 mode.

Features

- 0.24 inch(6.0mm)Digit Height
- Continuous uniform segments
- Low power requirement
- Excellent characters appearance
- Wide viewing angle
- Solid state reliability

Description

The GT-60241BGH-B is a 0.24 (6.0mm) digit height 6 digit seven-segment with several icons display. This device is multi-color applicable display,it uses HIGH-BRIGHT-GREEN/RED LED chipcs. The display has a black face and white segments.

Device

Part no.	Description
GREEN/RED	Multiplex Common Anode
GT-60241BGH-B	

PIN CONNECTION

NO	CONNECTION
1	COMMON ANODE COM1
2	CATHODE F
3	COMMON ANODE DIG1
4	CATHODE B
5	COMMON ANODE DIG2
6	CATHODE C
7	CATHODE E
8	COMMON ANODE DIG3
9	CATHODE A
10	CATHODE D
11	COMMON ANODE DIG4
12	CATHODE G
13	COMMON ANODE DIG5
14	COMMON ANODE DIG6
15	COMMON ANODE COM2

SIZE: 51.5mm × 15.5mm × 8.0mm

Absolute Maximum Ratings

Parameter	Symbol	Ratings
Peak Forward current per Dice (Duty cycle 1/10.10KHZ)	I _{pf}	100mA
Continuous Forward current per Dice	I _f	25 mA
Reverse Voltage	V _R	5V
Operating Temperature	T _{opr}	-25to+85
Storage temperature	T _{stg}	-25to+85
Soldering Temperature: 1/16Inch below seating place for 5 seconds		260

Electro-Optical Characteristics:

--RED

Parameter	Symbol	Condition	Typ.	Max.	Unit
Forward Voltage	V _F	I _F =20mA	1.85	---	V
Reverse Current	I _R	V _R =5V	---	50	uA
Luminous Intensity	I _V	I _F =20mA	9	---	mcd
Peak Emission Wavelength	P	I _F =20mA	642	---	nm
Spectrum width of Half Value		I _F =20mA	20	---	nm

--GREEN

Parameter	Symbol	Condition	Typ.	Max.	Unit
Forward Voltage	V _F	I _F =20mA	2.0	---	V
Reverse Current	I _R	V _R =5V	---	50	uA
Luminous Intensity	I _V	I _F =20mA	22	---	mcd
Peak Emission Wavelength	P	I _F =20mA	570	---	nm
Spectrum width of Half Value		I _F =20mA	30	---	nm

Recommend : It should be drive by stable current

2. Schematic Circuit Diagram

SIZE: 51.5mm × 15.5mm × 8.0mm

Package Dimension (Unit:mm Tolerance: ±0.2mm)

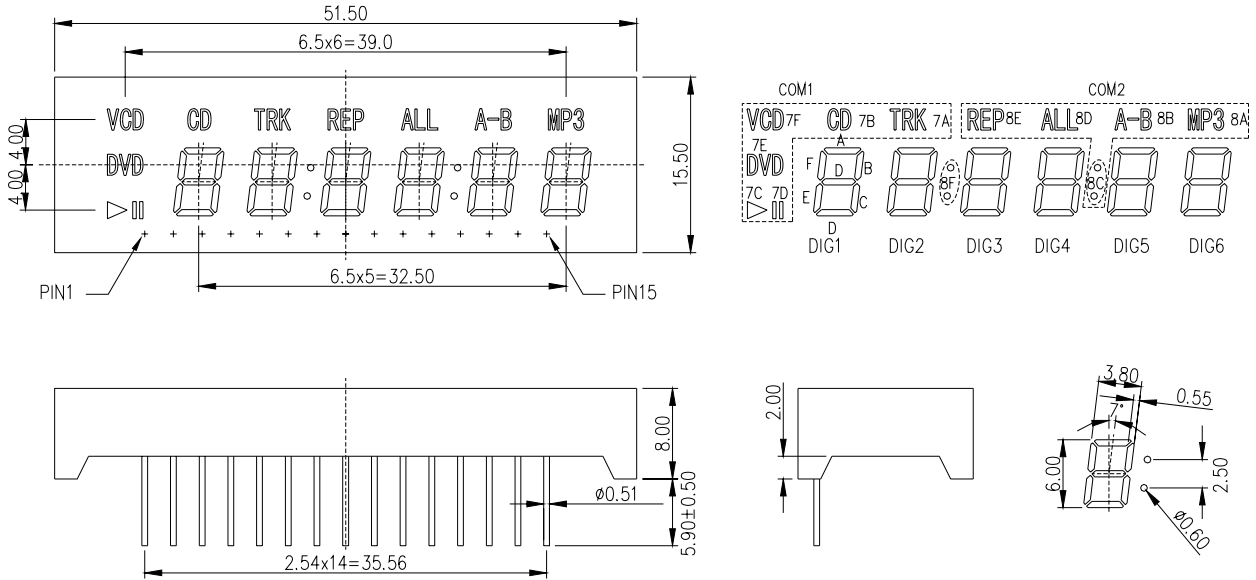

Internal Circuit Diagram

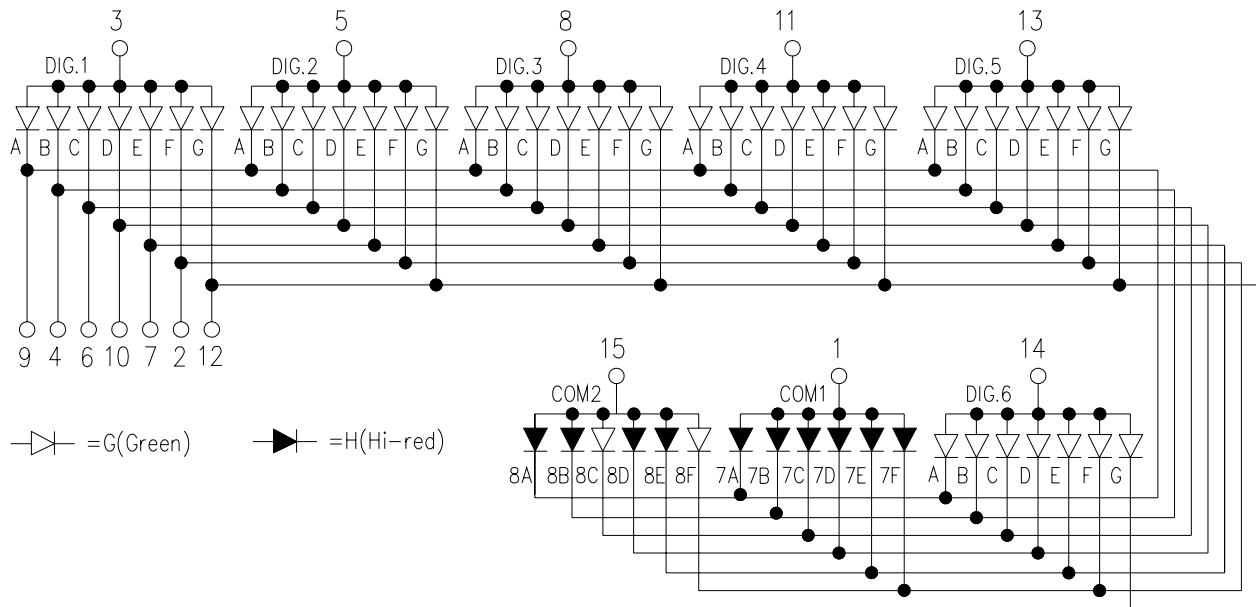

5. Service Tools and Equipment

5.1 Service Tools and Equipment Table

Application	Name
General	DVD Testing Disc
	General Tools (screwdriver etc.)
Confirm	CD Testing Disc
	VCD Testing Disc
Adjust	Decode Amplifier
	Speaker
	AV Cables
	TV Monitor
Grounding for electrostatic breakdown	Searing-iron
	Antistatic wrist strap
	Conductive material steel sheet

5.2 Storing and Handling Test Discs

It is important for a DVD testing disc keeping its surface precise.

Please care for storing and using it.

1. Do not place the disc on worktable directly after using.
2. Do not store discs in places subject to direct sunlight or near heat sources.

3. Do not place the disc on a glass surface. It may damage the disc. If this happened, please use a new testing disc adjust DVD player precision.

5.3 Notes

PLEASE READ ALL NOTES GIVEN IN THIS MANUAL.

- Locate
 - Place the unit on a firm, flat surface.
 - Do not place in a high temperature (upwards of 35 °C) or high wet (upwards of 90 percent) area.
 - Do not place in an area with a lot of dust.
 - Keep away from direct sunlight & domestic heating equipment.
- Do not fall any objects into the unit.
 - Care should be taken so that liquids are not spilled into the unit openings. Such situations could result in fire or electrical shock.
 - Keep the DVD video player away from any magnetic articles such as speaker etc.
- Superposition
 - Please place the DVD player horizontally. Do not place a heavy object (amplifier, receiver) on it. The object may fall, causing serious

personal injury or death.

This unit should be situated away from heat source, such as amplifiers, radiators, stoves or any other units producing heat.

Condensation

Lens could be moistening in these cases.

Turn on heater shortly,

In a very wet room,

Move the player from a cold environment to a heat environment quickly.

Being moisture inside the play could operate normally. Please turn on power and wait about an hour for drying the moisture.