



STEREO TAPE RECORDER

MODEL 4400

ALSO APPLICABLE TO MODEL
4400D STEREO TAPE DECK

SECTION 1	SERVICE MANUAL	2
SECTION 2	PARTS LIST	17
SECTION 3	SCHEMATIC DIAGRAM	36

SECTION 1

SERVICE MANUAL

TABLE OF CONTENTS

I. SPECIFICATIONS	3
II. MEASURING METHOD	4
1. TAPE SPEED DEVIATION	4
2. WOW AND FLUTTER	4
3. FREQUENCY RESPONSE	4
4. SIGNAL TO NOISE RATIO	4
5. TOTAL HARMONIC DISTORTION FACTOR	5
6. CROSS TALK (Cross talk between the tracks)	5
7. ERASE RATIO	5
8. POWER OUTPUT (4400 only)	5
III. DISMANTLING OF UNIT	6
IV. OPEN REEL MECHANISM ADJUSTMENTS	8
1. PINCH WHEEL ADJUSTMENT	9
2. SUPPLY REEL SHAFT ASSEMBLY ADJUSTMENT	9
3. TAKE-UP REEL SHAFT ASSEMBLY ADJUSTMENT	9
4. RECORDING/PLAYBACK CHANGING MECHANISM	9
V. HEAD ADJUSTMENTS	10
1. HEAD HEIGHT ADJUSTMENT	10
2. HEAD SLANT ADJUSTMENT	10
3. HEAD AZIMUTH ALIGNMENT ADJUSTMENT	10
VI. AMPLIFIER ADJUSTMENTS	11
1. PLAYBACK LEVEL ADJUSTMENT	11
2. RECORDING LEVEL ADJUSTMENT	11
3. RECORDING BIAS FREQUENCY ADJUSTMENT	13
4. RECORDING BIAS VOLTAGE ADJUSTMENT (FREQUENCY RESPONSE ADJUSTMENT)	13
5. ERASE VOLTAGE	13
VII. DC RESISTANCE	15
1. HEAD DC RESISTANCE	15
2. MOTOR DC RESISTANCE	15
VIII. COMPOSITE VIEWS OF COMPONENTS	16

I. SPECIFICATIONS

An asterisk next to a figure indicates the minimum guaranteed performance.

TRACK SYSTEM		4-track 2-channel stereo system
REEL CAPACITY		Up to 7" reel
TAPE SPEED		7-1/2 and 3-3/4 ips $\pm 2\%$ (*3%)
WOW AND FLUTTER		Less than 0.15% (*0.22%) RMS at 7-1/2 ips Less than 0.20% (*0.30%) RMS at 3-3/4 ips
FREQUENCY RESPONSE	AKAI SRT Tape Regular Tape	30 to 23,000 Hz (*40 to 22,000 Hz) ± 3 dB at 7-1/2 ips 30 to 15,000 Hz (*40 to 13,000 Hz) ± 3 dB at 3-3/4 ips 30 to 20,000 Hz (*40 to 20,000 Hz) ± 3 dB at 7-1/2 ips 30 to 13,000 Hz (*40 to 11,000 Hz) ± 3 dB at 3-3/4 ips
SIGNAL TO NOISE RATIO		Better than 50 dB at 7-1/2 ips Better than 48 dB at 3-3/4 ips
HUM AND NOISE (4400 only)		Less than 5 mV at minimum volume
DISTORTION		Less than 1.5% (*2.0%) at 7-1/2 ips Less than 2.5% at 3-3/4 ips
CROSS TALK		Better than 70 dB (*60 dB) monaural Better than 50 dB (*45 dB) stereo
ERASE RATIO		Better than 70 dB
INPUTS	Mic input Line input Din input	0.8 mV Impedance: 5 k Ω 70 mV Impedance: 150 k Ω 7 mV
OUTPUTS	Line output Din output Speaker output (4400 only)	1.228V (4 \pm 1 dB), using a 250 Hz "O" VU recorded tape 0.4V 16W total music power at 8 Ω 12W (*8W) continuous power at 8 Ω
BIAS FREQUENCY		105 kHz $\pm 5\%$
BIAS LEAK		Less than -30 VU
HIGH FREQUENCY DEVIATION		Within 2 dB, using an 8,000 Hz 3-3/4 ips recorded tape at 7-1/2 ips
RECORDING CAPACITY		60 min. stereo recording, using a 1,200 ft. tape at 7-1/2 ips
FAST FORWARD AND REWIND TIME		152/190 sec., using a 1,200 ft. tape at 60/50 Hz
MOTOR		4-pole induction 1-speed motor Type: SSM-1 Revolutions: 1,800/1,500 rpm. at 60/50 Hz
HEADS	Recording Head Playback Head Erase Head	In-line 4-track 2-channel recording head Type: P4-154 Gap: 1 micron Impedance: 95 Ω $\pm 15\%$ at 1,000 Hz In-line 4-track 2-channel playback head Type: P4-150 Gap: 1 micron Impedance: 1,250 Ω $\pm 15\%$ at 1,000 Hz In-line 4-track 2-channel erase head Type: E4-200 Gap: 0.6 mm Impedance: 200 Ω $\pm 5\%$ at 100 kHz
TRANSISTORS		2SC458LG(C) (D) ... 6 2SC871(E) (F) ... 2 2SC971(2) (3) (red) ... 2 2SC1098(L) (M) ... 1
IC		LD3141 ... 4 STK-011 ... 2 (4400 only)
DIODES		1N34A ... 2 10DC-1 ... 1 WZ-240 ... 1
POWER SUPPLY		100 to 240V A.C., 50/60 Hz 120V A.C., 60 Hz for CSA/UL Models 220V A.C., 50 Hz for CEE Models
POWER CONSUMPTION		60W DECK: 35W
INSULATION RESISTANCE		More than 50 M Ω
INSULATION DURABILITY		1,000V A.C. for more than 1 min. duration
DIMENSIONS		406(W) x 314(H) x 194(D) mm (15.9" x 12.4" x 7.6")
WEIGHT		13.7 kg (30.1 lbs.)

NOTE: Specifications subject to change without notice.

II. MEASURING METHOD

1. TAPE SPEED DEVIATION

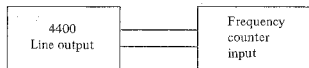

Fig. 1

As shown in Fig. 1, connect a Frequency Counter to the Line Output of Model 4400. Take a frequency counter reading at the beginning, middle, and end of tape winding during playback. The maximum value of these respective readings will represent tape speed deviation.

2. WOW AND FLUTTER

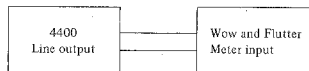

Fig. 2

Method A

As shown in Fig. 2, connect the Line Output of Model 4400 to the Input of a Wow and Flutter Meter. Use a 3,000 Hz pre-recorded test tape and take a wow and flutter meter reading at the beginning, middle, and end of tape winding. The maximum value of these respective readings will represent the wow and flutter.

Method B

Supply a 3,000 Hz sine wave signal from an Audio Frequency Oscillator and make a recording on a blank tape at the beginning, middle, and end of tape winding. Rewind and Playback tape. Measure wow and flutter with a Wow and Flutter Meter. (The wow and flutter value of Method B will be close to twice that of Method A.)

3. FREQUENCY RESPONSE

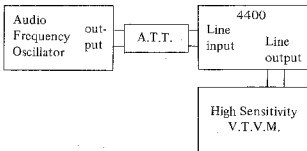

Fig. 3

For measuring frequency response, connect instruments as shown in Fig. 3 and proceed as follows:

- 1) Supply a 1,000 Hz sine wave to the Line Input of Model 4400 from an Audio Frequency Oscillator through an Attenuator. Set recorder to recording mode and turn recording level volume control to maximum. Adjust Attenuator to obtain a +4 dB V.T.V.M. reading.
- 2) Under conditions described in 1) above, re-adjust Attenuator so that the Line Output is -16 dB, and record 40 to 20,000 Hz spot frequencies.
- 3) Rewind tape and playback from the beginning. Take V.T.V.M. spot frequency readings and plot values on a graph.

NOTE: When measuring frequency response, new tape should be used.

4. SIGNAL TO NOISE RATIO



Fig. 4

As shown in Fig. 4, connect a High Sensitivity V.T.V.M. to the Line output of Model 4400. Playback a 250 Hz "0" VU pre-recorded test tape and measure the output. Then remove the tape and measure the noise level under the same condition. Convert each of the measured values into decibels.

5. TOTAL HARMONIC DISTORTION FACTOR

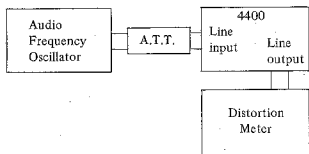

Fig. 5

Connect the measuring instruments as shown in Fig. 5 and record a 1,000 Hz sine wave signal at "0" VU. Playback the resultant signal and measure the overall distortion factor. Measure the noise level of the tape recorder without the tape. Connect the Audio Frequency Oscillator directly to the distortion meter for measurement of the distortion factor of the oscillator. The required distortion factor can be obtained from the results of the above measurement by the following formula:

$$d_0 = d - d_1 - d_2$$

where, d_0 = Required distortion factor
 d = Overall distortion factor
 d_1 = Noise level
 d_2 = Distortion factor of the oscillator

NOTE: When measuring the distortion factor, new tape should be used.

6. CROSS TALK

(Cross talk between the tracks)

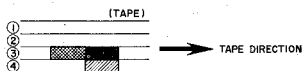

Fig. 6

As shown in Fig. 6, first record a 1,000 Hz sine wave signal on Track No. 3 at +3 VU level. Next, record under a non-input condition. Then, playback the tape on Tracks No. 3 and 4 through the B.P.F. (band pass filter sensitivity . . . 1:1) and obtain a ratio between the two from the following formula:

$$C = 20 \log \frac{E_0}{E_2 - E_1} \text{ (dB)}$$

where, C = Desired cross talk ratio (dB)
 E_0 = 1,000 Hz signal output level (solid black)
 E_2 = 1,000 Hz cross talk level (hatched)
 E_1 = Non-input signal recorded level (cross-hatched)

7. ERASE RATIO

As shown in Fig. 4, connect a High Sensitivity V.T.V.M. to the Line Output of Model 4400. Playback a virgin tape and take a V.T.V.M. reading of the output level. Next, record a 1,000 Hz sine wave signal at +3 dB, then playback this recorded signal and take a V.T.V.M. reading of the output level. Next, using this pre-recorded tape, record under a non-input condition and take a reading of the noise level output of the erased signal and obtain a ratio between the two from the following formula:

$$E_r = 20 \log \frac{E_0}{E_2 - E_1} \text{ (dB)}$$

where, E_r = Desired erase ratio (dB)
 E_0 = 1,000 Hz signal output level
 E_2 = Non-input signal recorded level
 E_1 = Virgin tape noise output level

8. POWER OUTPUT (4400 onTy)

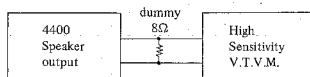

Fig. 7

As shown in Fig. 7, connect an 8Ω dummy load resistor to the speaker output of the recorder and connect this terminal to a High Sensitivity V.T.V.M. Playback a 250 Hz "0" VU pre-recorded test tape and take a V.T.V.M. reading of the output level. The resultant output can be obtained from the results of the above measurement by using the following formula:

$$P = \frac{E^2}{R} \text{ (W)}$$

where, P = Desired power output (watts)
 E = Measured voltage (R.M.S.)
 $R = 8\Omega$

III. DISMANTLING OF UNIT

In case of trouble, etc. necessitating disassembly, please disassemble in the order shown in photographs. Re-assemble in reverse order.

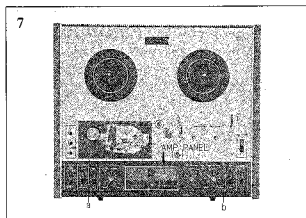
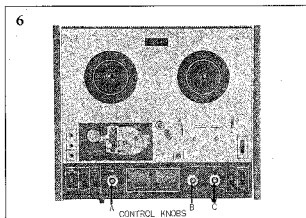
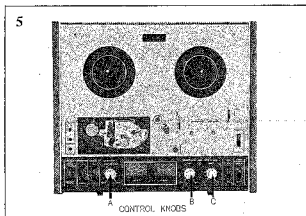
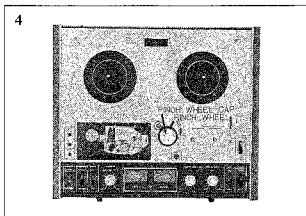
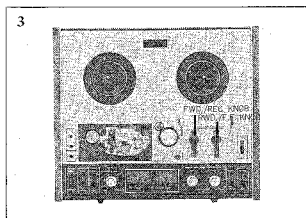
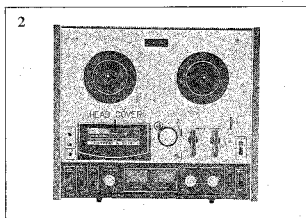
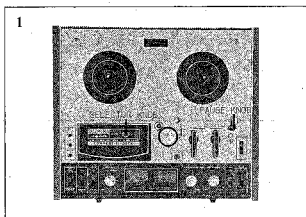

8

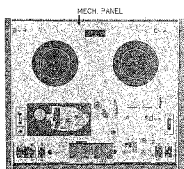

12

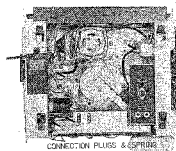

9

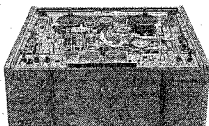

13

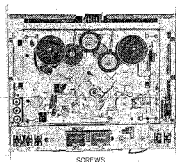

10

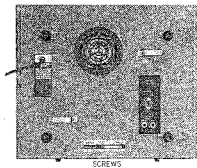

14

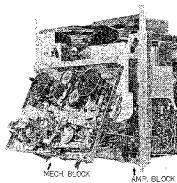

11

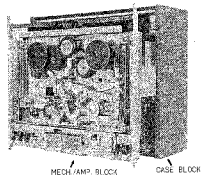

15

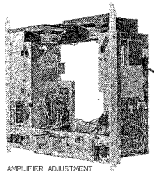

IV. OPEN REEL MECHANISM ADJUSTMENTS

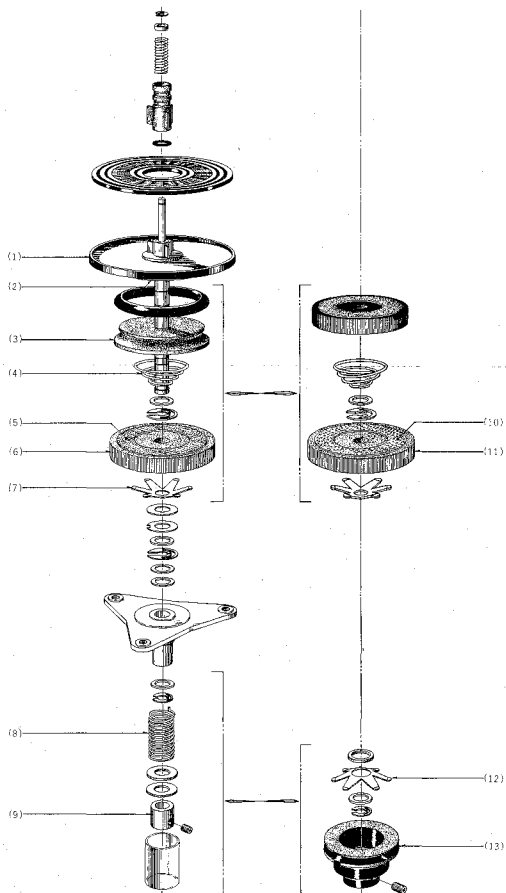

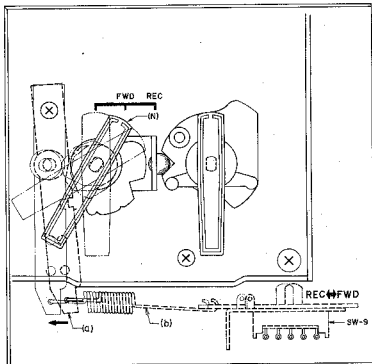

Fig. 9

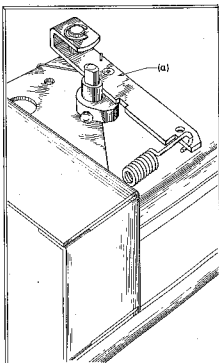

Fig. 10

1. PINCH WHEEL ADJUSTMENT

It is important that the pinch wheel shaft be kept in perfect alignment with the capstan shaft. Proper pinch wheel pressure is between 1,000 and 1,150 grams when the unit is operated at the tape speed of 7-1/2 ips. Any deviation from this specification will result in wow and flutter. Check pinch wheel pressure with a spring scale, and if necessary, adjust the pinch wheel load spring.

2. SUPPLY REEL SHAFT ASSEMBLY ADJUSTMENT (See Fig. 8 at left)

Felt clutch material (2) is used between the lower side of the reel table base plate (1) and the rewind pulley (3) to protect recording tape from excessive tension during rewind operation. To check the amount of friction of this part, install a 5-inch reel with a 60 mm diameter tape and gently pull the end of the tape upward with a spring scale. Adjust the conical spring (4) so that the amount of tension is kept between 400 and 500 grams. Other felt clutch material (5) is attached to the supply roller (6) to provide proper slippage during FWD and REC operation. The procedure for checking friction of this part is the same as the foregoing, and between 80 and 100 grams of tension gives best results. Adjust the spring (7) just under the supply roller (6). When the unit is set to fast forward operation, the amount of friction will decrease to from 15 to 20 grams. Check to see whether this is satisfactory. If not, adjust the spring plate (8) and the pressure of the pulley (9).

3. TAKE-UP REEL SHAFT ASSEMBLY ADJUSTMENT (See Fig. 8 at right)

Felt clutch material (2) is attached to the bottom side of the reel table base plate (1) so that the recording tape will not stretch during fast forward operation due to excessive tension. To check the amount of friction of this part, install a 5-inch reel with a 60 mm diameter tape, and gently pull the end of tape upward with a spring scale. Adjust the conical spring (4) so that the amount of tension at this part is kept between 400 and 500 grams. Other felt clutch material (10) is attached to the take-up roller (11). This is to provide proper slippage during FWD or REC operation. The procedure for checking friction of this part is the same as the foregoing, and between 150 and 180 grams of friction provides the best results. Adjust the spring plate (7) just under the take-up roller (11). When the unit is set to rewind operation, the amount of friction of this part will decrease to from 15 to 20 grams. Check to see whether this is satisfactory. If not, adjust the spring (12) and the pressure of the set sleeve (13).

4. RECORDING/PLAYBACK CHANGING MECHANISM (See Figs. 9, 10)

Turning the FWD/REC knob (N) to recording position causes Lever (a) to pull. Recording Lever (b) (as illustrated by dotted line), and the FWD/REC Changing Switch (SW-9) is turned to recording position. If Lever (a) does not pull Lever (b) properly, Changing Switch SW-9 will not operate properly. This may cause abnormal oscillation and inability to record. In this case, loosen Screw (c) and adjust lever.

V. HEAD ADJUSTMENTS

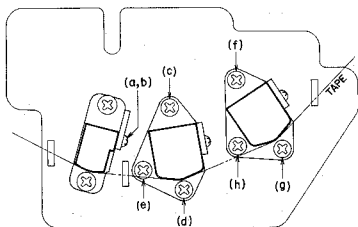

Fig. 11

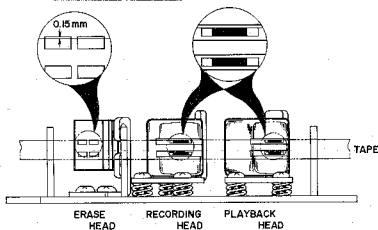

Fig. 12

Since adjustment of the Heads critically affects tape recorder performance, it is essential that Heads be carefully adjusted with precision measuring equipment and suitable recorded tape.

1. HEAD HEIGHT ADJUSTMENT

(See Figs. 11, 12)

1) Erase Head

Adjust height control screws (a), (b) by turning to left and right so that the upper edge of the tape is 0.15 mm lower than the upper edge of the erase head core.

2) Recording Head

Adjust the screws (c), (d) by turning to left and right until the width between the upper edge of channel 1 head core and upper edge of the tape is equal.

3) Playback Head

Adjust the screws (f), (g) by turning to left and right until the width between the upper edge of channel 1 head core and upper edge of the tape is equal.

2. HEAD SLANT ADJUSTMENT

(See Figs. 11, 12)

Adjust the screws (Head Height control screws) by turning to left and right so that each head (Erase, Recording and Playback Head) contacts the tape surface at a right angle.

3. HEAD AZIMUTH ALIGNMENT

ADJUSTMENT (See Figs. 11, 12)

1) Playback Head

Playback an Ampex Alignment test tape (8,000 Hz 3-3/4 ips.) at 7-1/2 ips. Adjust screw (h) by turning to left and right until the various line outputs are maximum.

2) Recording Head

At recording mode, supply a 15,000 Hz sine wave at a -16 dB recording level from an Audio Frequency Oscillator to the line input of the 4400, and set the Monitor switch to "TAPE" position. Then adjust screw (e) by turning to left and right until the various line outputs are maximum.

4. Repeat adjustments outlined in Items 1-2) to 3, above 2 or 3 times to obtain optimum adjusted condition.

VI. AMPLIFIER ADJUSTMENTS

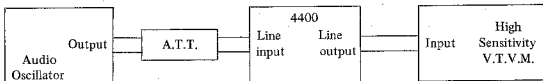

Fig. 13

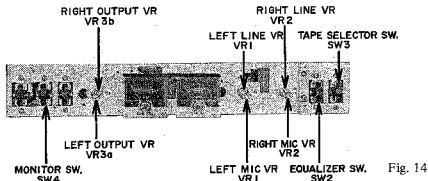

Fig. 14

1. PLAYBACK LEVEL ADJUSTMENT

(See Figs. 13 to 16)

- 1) Set the Monitor switch to "TAPE" position and Equalizer switch to 7-1/2 ips.
- 2) In case of 4400D, set output VR (VR3a, b 10 k Ω) to maximum.
- 3) Connect a High Sensitivity V.T.V.M. to the line output.
- 4) Playback a 250 Hz pre-recorded test tape at 7-1/2 ips., and adjust semi-fixed resistor VR2 and VR2b (20 k Ω) to obtain a 4 dB P.B. level. (VU meter indicates "0" VU.)

Recording Amplifier Adjustment should be made only after Head Adjustments and Playback Amplifier Adjustments have been made.

2. RECORDING LEVEL ADJUSTMENT

(See Figs. 13 to 16)

- 1) Set the Monitor switch to "TAPE" position and Equalizer switch to 7-1/2 ips.
- 2) Connect an Audio Frequency Oscillator to the line input and High Sensitivity V.T.V.M. to the line output.
- 3) Load a Scotch-111 blank tape and set recorder to "REC" mode.
- 4) In case of 4400D, set output VR (VR3a,b 10 k Ω) to maximum.
- 5) Supply a 1,000 Hz sine wave from an Audio Frequency Oscillator and adjust the line recording level control volumes (VR1 and VR2 50 k Ω) until the line output level reaches 4 dB. (VU meter indicates "0" VU.)
- 6) Set the Monitor switch to "SOURCE" position.
- 7) Adjust semi-fixed resistor VR1 and VR1b (2 k Ω) to obtain 4 dB recording level. (VU meter indicates "0" VU.)
- 8) Repeat 2 times in the same way as indicated in Items 5) to 8) above.

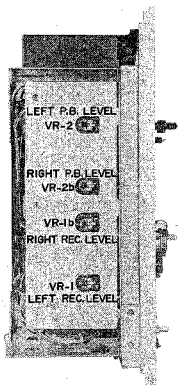

Fig. 15

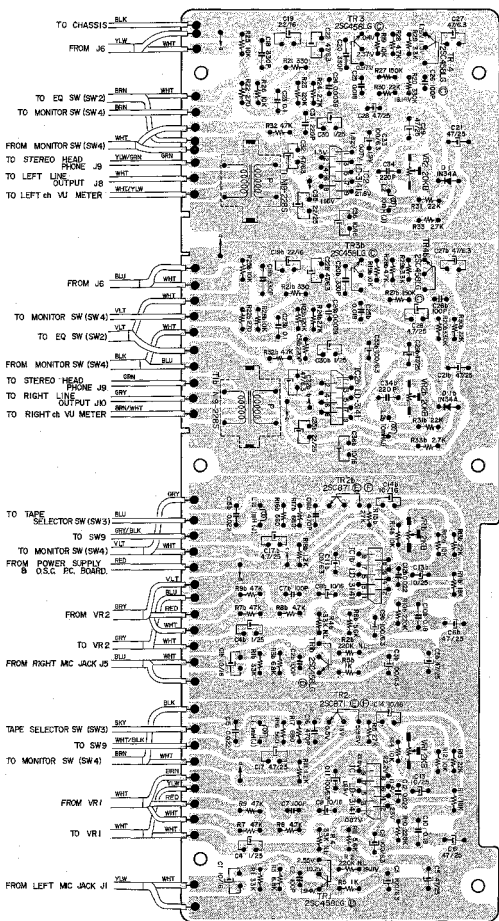

Fig. 16 PRE-AMP. P.C. BOARD (LE-5022)

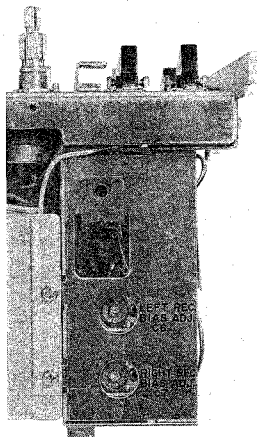

Fig. 17

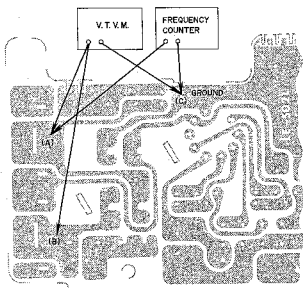

Fig. 18

3. RECORDING BIAS FREQUENCY ADJUSTMENT (See Fig. 18)

- 1) Set the recorder to recording mode.
- 2) Connect a Frequency counter to points (A) and (C) in Fig. 18 of the Oscillator P.C. Board (LE-5021) and read the frequency indication.
- 3) If the bias frequency is 105 kHz \pm 5%, the bias frequency is correct.
- 4) If the bias frequency is incorrect, it can be adjusted by changing the value of condenser C8 (5600 PF) of the oscillator P.C. Board (LE-5021).

4. RECORDING BIAS VOLTAGE ADJUSTMENT (FREQUENCY RESPONSE ADJUSTMENT) (See Figs. 17, 18)

- 1) Set the Monitor switch to "TAPE" position and Equalizer switch to 7-1/2 ips.
- 2) Connect an Audio Frequency Oscillator to the line input through an Attenuator and a High Sensitivity V.T.V.M. to the line output.
- 3) Load a blank test tape "AKAI 100L" (Fuji S-100) and set the recorder to "REC" mode.
- 4) Turn recording level control volume VR1 and VR2 (50 kA) to obtain 4 dB V.T.V.M. reading.
- 5) Under conditions described in Item 4) above, readjust attenuator so that the line output level is -16 dB.
- 6) Record from 40 to 20,000 Hz spot frequencies.
- 7) Adjust Bias Adjustment semi-fixed condenser C6 (70 PF max.) so that the output of 1,000 Hz and 15,000 Hz frequencies are equal.
- 8) The bias voltage at this time is around 11V A.C.

5. ERASE VOLTAGE

- 1) Set the recorder to "REC" mode.
- 2) Connect a V.T.V.M. to points (B) and (C) in Fig. 18 of the oscillator P.C. Board (LE-5021) and read the V.T.V.M. indication.
- 3) The Erase Voltage is around 52V A.C.

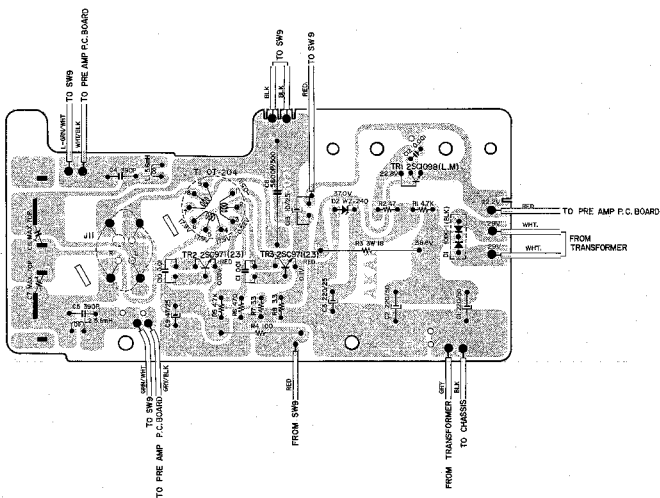

Fig. 19 OSC. POWER P.C. BOARD (LE-5021)

VII. DC RESISTANCE

1. HEAD DC RESISTANCE

P.B. Head	91.5 Ω \pm 10 Ω
REC. Head	15.3 Ω \pm 10 Ω
ERASE Head	3.5 Ω \pm 1 Ω

2. MOTOR DC RESISTANCE

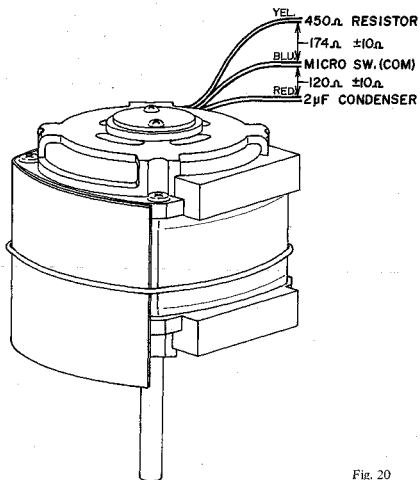
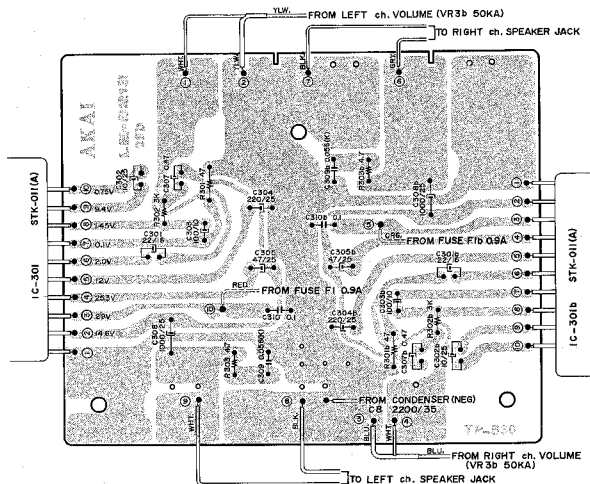

Fig. 20

VIII. COMPOSITE VIEWS OF COMPONENTS

MAIN AMP. P.C. BOARD (LE-5213)



SECTION 2

PARTS LIST

TABLE OF CONTENTS

FIG. 1	HEAD BLOCK	21
FIG. 2	SUPPLY/TAKE-UP REEL TABLE BLOCK	21
FIG. 3	MOTOR BLOCK	23
FIG. 4	FLYWHEEL/BELT CHANGE LEVER BLOCK	24
FIG. 5	SWITCH BLOCK	25
FIG. 6	MECHANISM ASSEMBLY BLOCK	26
FIG. 7	PRE-AMP. P.C. BOARD (LE-5022) BLOCK	27
FIG. 8	OSC. POWER SUPPLY P.C. BOARD (LE-5021) BLOCK	28
FIG. 9	MAIN AMP. BLOCK	30
FIG. 10	AMPLIFIER ASSEMBLY BLOCK	31
FIG. 11	FINAL ASSEMBLY BLOCK	33
	INDEX	34

HOW TO USE THIS PARTS LIST

1. This parts list is compiled by various individual blocks based on assembly process.
2. When ordering parts, please describe parts number, serial number, and model number in detail.
3. How to read List

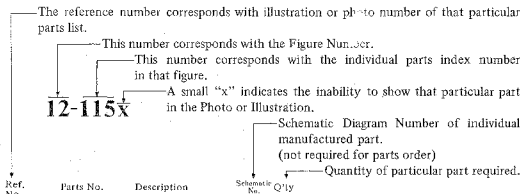

Ref. No.	Parts No.	Description	Schematic No.	Qty
FLYWHEEL BLOCK #13				
12-115x	800425	Flywheel Block Assy. Comp. RDG #13		1
12-116	244506	Flywheel Only	RU-233	1
12-117x	244754	Felt, Flywheel	RU-275	1
12-118	251324	Main Metal Case	RU-236	1
12-119	253080	Main Metal	RU-237	1

4. The symbol numbers shown on the P.C. Board list can be matched with the Composite Views of Components of the Schematic Diagram or Service Manual.
5. The indications of Resistors and Capacitors in the photos of P.C. Board are being eliminated.
6. The shape of the parts and parts name, etc. can be confirmed by comparing them with the parts shown on the Electrical Parts Table of P.C. Board.
7. Both the kind of part and installation position can be determined by the Parts Number. To determine where a parts number is listed, utilize Parts Index at end of Parts List.
It is necessary first of all to find the Parts Number. This can be accomplished by using the Reference Number listed at right of parts number in the Parts Index. (meaning of ref. no. outlined in Item 3 above).
8. Utilize separate "Price List for Parts" to determine unit price. The most simple method of finding parts Price is to utilize the reference number.

ELECTRICAL PARTS TABLE

<p>ELECTRICAL PARTS LIST TABLE Because the indications of resistors and capacitors in the P.C. Board photos are being eliminated, please confirm parts name and shape by comparing them with the parts shown in this table.</p>	<p style="text-align: center;">1</p>  <p style="text-align: center;">Solid Resistor</p>	<p style="text-align: center;">2</p>  <p style="text-align: center;">Insulator Type Carbon Resistor</p>	<p style="text-align: center;">3</p>  <p style="text-align: center;">Metal Oxide Film Resistor</p>
<p style="text-align: center;">4</p>  <p style="text-align: center;">Cement Resistor</p>	<p style="text-align: center;">5</p>  <p style="text-align: center;">Wire-Wound Resistor</p>	<p style="text-align: center;">6</p>  <p style="text-align: center;">Thermistor</p>	<p style="text-align: center;">7</p>  <p style="text-align: center;">Enamel Resistor</p>
<p style="text-align: center;">1</p>  <p style="text-align: center;">MP Capacitor (Tubular Type)</p>	<p style="text-align: center;">2</p>  <p style="text-align: center;">Plastic Capacitor</p>	<p style="text-align: center;">3</p>  <p style="text-align: center;">Mylar Capacitor</p>	<p style="text-align: center;">4</p>  <p style="text-align: center;">VFM (Hi-Q) Capacitor</p>
<p style="text-align: center;">5</p>  <p style="text-align: center;">Mylar Capacitor</p>	<p style="text-align: center;">6</p>  <p style="text-align: center;">Tantalum Capacitor</p>	<p style="text-align: center;">7</p>  <p style="text-align: center;">Oil Capacitor (Tubular Type)</p>	<p style="text-align: center;">8</p>  <p style="text-align: center;">Vertical Type Tubular Type Styrofoam Capacitor</p>
<p style="text-align: center;">9</p>  <p style="text-align: center;">Electrolytic Capacitor (Tubular Type)</p>	<p style="text-align: center;">10</p>  <p style="text-align: center;">Vertical Type Tubular Type Electrolytic Capacitor</p>	<p style="text-align: center;">11</p>  <p style="text-align: center;">Ceramic Capacitor</p>	<p style="text-align: center;">12</p>  <p style="text-align: center;">Metalized Mylar (Paper) Capacitor</p>
<p style="text-align: center;">13</p>  <p style="text-align: center;">Trimmer Condenser</p>		<p style="text-align: center;">VR</p>  <p style="text-align: center;">Semi-Fixed Volume</p>	
<p style="text-align: center;">L</p>  <p style="text-align: center;">Ferrite Inductor</p>	<p style="text-align: center;">TR</p>  <p style="text-align: center;">Transistor</p>		
<p style="text-align: center;">CR</p>  <p style="text-align: center;">Spark Quencher</p>	<p style="text-align: center;">D</p>  <p style="text-align: center;">Diode (Silicon, Zener, Germanium)</p>		

FIG. 1 ILLUSTRATION OF HEAD BLOCK

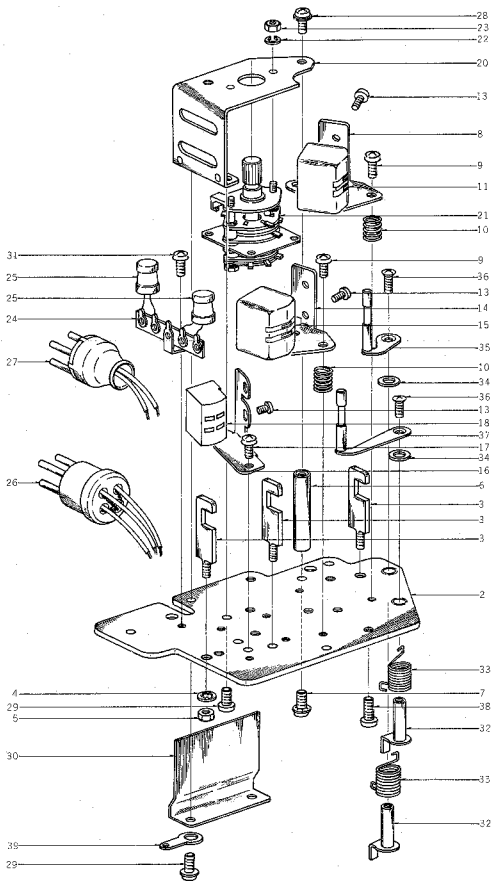

SUPPLY/TAKE-UP REEL TABLE BLOCK

Ref. No.	Parts No.	Description	Schematic No.	Q'ty
2-1x	BR490184	Supply Reel Table Block	Comp. LE-2	1
2-2x	BR490206	Take-up Reel Table Block	Comp. LE-2	1
2-3	MT368684	Reel Table Disk A, w/shaft A	XR-111	2
2-4x	MT252112	Friction Cloth B	900-225	2
2-5	MT317463	MR Reel Table Rubber	MR-250	2
2-6	MS255600	Reel Shaft B	XR-103	2
2-7	MT297663	3R 'O' Ring 2.9x1.65M	3R-136	2
2-8	MT255420	Reel Retainer	3R-102	2
2-9	ZG255633	Reel Spring	3R-169	2
2-10	MT255565	Reel Shaft Ring	XR-177	2
2-11	ZW270088	'E' Ring 1.9M	6-19	2
2-12	MR251460	Rewind Pulley	900-222	1
2-13	MT222366	Rubber Ring	900-234	1
2-14	ZG227553	Spring G2 (Left)	900-220	1
2-15	ZW260021	Washer (SUP) D6.1x10x0.13t		3
2-16	ZW260054	Washer (SUP) D6.1x10x0.25t		3
2-17	ZW260065	Washer (SUP) D6.1x10x0.35t		3
2-18	MT255870	Reel Table Thrust Retainer Pin	900-237	2
2-19x	MT252101	Friction Cloth A	900-224	1
2-20	MR252066	Take-up Roller C	900-220	1
2-21	MT255971	Reel Table Spring Plate A	900-227	1
2-22	MT438647	Reel Torque Adjust Thrust 7		2
		D6.2x13x0.5t	101022	2
2-23	ZW231693	Claw Thrust Washer	900-225	2
2-24x	MT438592	Reel Torque Adjust Thrust 2		2
		D6.1x10x0.3t	101017	2
2-25x	MT438603	Reel Torque Adjust Thrust 3		2
		D6.1x10x0.5t	101018	2
2-26	MT292386	XR Reel Metal Mt. Part,		2
		w/metal B	XR-191	2
2-27	MT438614	Reel Torque Adjust Thrust 4		2
		D6.1x10x0.8t	101019	2
2-28	ZW312693	'E' Ring 4M	6-14	2
2-29	ZG434092	Spring F4-B	LF-2004	1
2-30	MT440313	Nylon Tube D12		3
2-31	MT438636	Reel Torque Adjust Thrust 6		2
		D6.2x13x1t	101021	3
2-32	MT228598	Set Sleeve B	CD-66	2
2-33	ZW434160	Set Screw, hexagon socket		1
		3x3 (cup)		1
2-34	MR252044	Take-up Roller A	900-218	1
2-35	ZG227542	Spring G2 (Right)	900-220	1
2-36	ZW260021	Washer (SUP) D6.1x10x0.13t		3
2-37x	ZW260054	Washer (SUP) D6.1x10x0.25t		2
2-38x	ZW260065	Washer (SUP) D6.1x10x0.35t		3
2-39	MT255870	Reel Table Thrust Retainer Pin	900-237	2
2-40x	MT252101	Friction Cloth A	900-224	1
2-41	MR252066	Take-up Roller C	900-220	1
2-42	MT255982	Reel Table Spring Plate B	900-228	1
2-43	MZ437804	Thrust A D7.9x13x1t		1
		(Flywhheel)	101024	1
2-44	MT255993	Reel Table Spring Plate C	M8-207	1
2-45	ZW260065	Washer (SUP) D6.1x10x0.35t		1
2-46	ZW270000	Retaining Pin D4	900-257	1
2-47	MR256094	Reel Table Pulley	900-230	1
2-48	ZW434171	Set Screw, hexagon socket		1
		4x7 (cup)		1
2-49x	MT438581	Reel Torque Adjust Thrust 1		1
		D5.8x10.3x1t	101016	1

HEAD BLOCK

Ref. No.	Parts No.	Description	Schematic No.	Q'ty
1-1x	BH490195	Head Block Comp.	LE-2	1
1-2	HZ490296	LD Head Base B (New), w/metal	LD-11	1
1-3	HZ274162	Tape Guide #1	ATR-5	3
1-4	ZW273802	Toothed Lock Washer M3		3
1-5	ZW273756	Nut M3		3
1-6	MH312827	LD Switch Prop. New	LD-13	1
1-7	ZW417025	Screw, binding head 3x8, w/washer		1
1-8	HZ480420	P.B. Angle Base	LE-0001	1
1-9	ZW464714	Screw, round head 3x12		6
1-10	ZG206144	Angle Adjust Spring	RD-15	6
1-11	HP375131	REC./P.B. HEAD P4-150		1
1-12x	HZ393974	I-MK Head Terminal Plate	HC-89	2
1-13	ZW477876	Screw, pan head 2x3		6
1-14	HZ480431	Rec. Angle Table	LE-0002	1
1-15	HR475446	REC. HEAD P4-154		1
1-16	HZ480442	Erase Head Base	LE-0003	1
1-17	ZS232728	Screw, binding head 3x5		2
1-18	HE384693	ERASE HEAD E4-200		1
1-19x	HZ480453	LD Switch Table Comp., New	LE	1
1-20	HZ312895	LD Switch Table, New	LD-12	1
1-21	ES257668	Rotary Switch ESR-E263L14AS	20-6-2	1
1-22	ZW273723	Spring Washer M2		2
1-23	ZW273734	Nut M2		2
1-24	EJ255115	Lug Plate VB2L2	33-4-3	1
1-25	EO390622	Ferri Inductor FL9H 220u(HK)	29-1-4	2
1-26	EJ297843	4P Plug, w/csp	42-1-3	1
1-27	EJ276963	T type 4P Plug	42-1-16	1
1-28	ZW417025	Screw, binding head 3x8, w/washer		1
1-29	ZW413223	Screw, binding head 3x5, w/washer		3
1-30	HZ480475	Head Shield	LE-0004	1
1-31	ZW323728	Screw, binding head 3x5		1
1-32	HL232503	Shift Lever B, w/shaft A	M9-3	2
1-33	ZG312928	Shifter Spring	LD-19	2
1-34	ZW336846	Washer (SPC) D4.1x7x1.2t		2
1-35	HL312941	Shift Lever, w/pin	LD-15	1
1-36	ZW480622	Screw, oval countersunk head 2.3x6		2
1-37	HL223536	Shift Lever C, w/pin	M9-5	1
1-38	ZW413155	Screw, binding head 3x6		1
1-39	ZW273778	Earth Lug M3		1

When ordering parts, please describe Parts Number, Serial Number, and Model Number in detail.

FIG. 4 ILLUSTRATION OF FLYWHEEL/
BELT CHANGE LEVER BLOCK

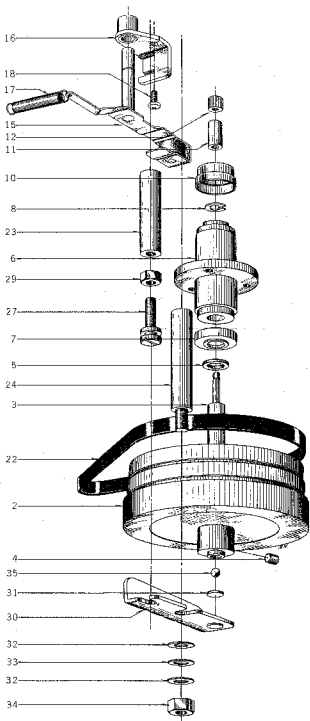

FLYWHEEL/BELT CHANGE LEVER BLOCK

Ref. No.	Parts No.	Description	Schematic No.	Q'ty
FLYWHEEL BLOCK				
4-1x	BF205075	Flywheel Block #5 Comp.		1
4-2	BF244473	Flywheel	767-S-10	1
4-3	MS244708	Flywheel Shaft	SRA-21	1
4-4	ZW373577	Set Screw, hexagon socket 5x6 (flat)		2
4-5	ZW447208	Flywheel Thrust B D7.9x13x0.51	101025	1
4-6	MZ296267	Main Case B 24 Comp.	1630-205	1
4-7	MZ446635	Thrust Cap, Main Metal B2	LF-2006	1
4-8	ZW244710	Flywheel Fixing Pin	960-250	1
4-9x	MZ244113	Felt D12.5x16x2t		1
4-10	MZ253113	Main Metal Cap B	MH-208	1
4-11	MY270055	Capstan D8	SRA-7	1
4-12	ZW293027	1100 Capstan Screw	SRA-6B	1
4-13x	ZW252977	Main Shaft Collar	SRA-22	1
BELT CHANGE LEVER BLOCK				
4-14x	BL203523	Belt Change Lever Block Comp. A		1
4-15	ML217451	Belt Change Lever (Small), w/roller B	MH-221	1
4-16	MZ248354	Belt Guide Stop, w/metal	4TR-221	1
4-17	ZG217337	Belt Return Spring	4TR-224	1
4-18	ZW417150	Screw, pan head 4x6		1
4-19x	ZG217394	Belt Change Spring B	MH-125	1
4-20x	ZW260054	Washer (SUP) D6.1x10x0.25t		1
4-21x	ZW290283	'U' Ring 2.85M	6-1-1	1
ASSEMBLY BLOCK				
4-22	MB256601	Double Face Flat Belt D=110	100912	1
4-23	MZ244631	Flywheel Prop B	4TR-115	1
4-24	MZ244620	Flywheel Prop A	4TR-116	1
4-25x	ZW424056	Screw, pan head 4x10		1
4-26x	ZW273914	Spring Washer M4		1
4-27	ZW244574	Flywheel Support Adj. Screw	4TR-114	1
4-28x	ZW231794	Tape Guide Washer (Small)	3A-555	1
4-29	ZW413278	Nut M5		1
4-30	MZ244530	Flywheel Support Plate B	M2-109	1
4-31	ZW235585	Nylon Plate D=8		1
4-32	ZW413998	Washer (SUP) D6.8x12.7x1t		1
4-33	ZW393232	Spring Washer 1/4"		1
4-34	ZW413280	Inch Nut 1/4" (Mountain 20)		1
4-35	MV269965	Steel Ball 4mm		1

When ordering parts, please describe Parts Number, Serial Number, and Model Number in detail.

FIG. 5 ILLUSTRATION OF SWITCH BLOCK

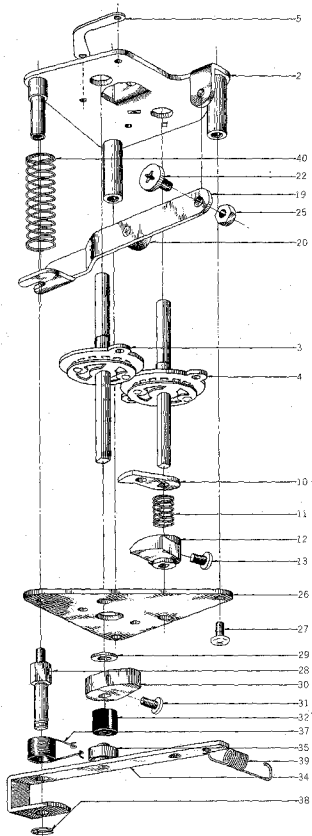

SWITCH BLOCK

Ref. No.	Parts No.	Description	Schematic No.	Q'ty
5-1x	BS480352	Switch Block Comp.	1.E	1
5-2	MZ316901	Switch Table A-2 (SX), w/prop	MR-201	1
5-3	ES316934	Y type Rwd. Shaft	25-6-5	1
5-4	ES369865	RCC Y type Rwd. Shaft	RCC-202	1
5-5	MZ316945	Nut Plate	MR-245	2
5-6x	ZW202138	Screw, binding head 3x6, w/washer	MR-242	4
5-7x	MZ316956	Cam A-3	MR-242	1
5-8x	ZW413201	Screw, pan head 4x8		1
5-9x	ZW260133	Washer (Fiber) D6.1x10x1t		2
5-10	MZ327341	Cam Trap Plate B	SX-201	1
5-11	ZG227586	Spring K	900-214	1
5-12	MZ327352	Cam C-2	SX-202	1
5-13	ZW201778	Screw, pan head 4x8		1
5-14x	ZW434215	Washer (Nylon) D6.1x10.3x 0.3t		1
5-15x	ZW434193	Washer (Nylon) D6.1x10.3x 0.5t		1
5-16x	MV270066	Steel Ball D8		1
5-17x	MZ217293	Cam B-2, without Tap	1630-201	1
5-18x	ZW416687	Screw, binding head 4x8		1
5-19	ML257128	Lever 1, w/shaft	900-209	1
5-20	MZ217203	Cam Roller A (Nylon)	900-163	1
5-21x	ZW290283	'U' Ring 2.85M	6-1-1	1
5-22	ZW217877	Pause Lever Retaining Screw	900-196	1
5-23x	ZW260166	Washer (Nylon) D6.2x13x 0.125t		1
5-24x	ZW273892	Toothed Lock Washer M4		1
5-25	ZW273960	Nut M4		1
5-26	MZ225720	Switch Table B-2	M9-304	1
5-27	ZW413201	Screw, pan head 4x8		2
5-28	MZ258581	Rec. Lever Prop	M9-303	1
5-29	ZW260133	Washer (Fiber) D6.1x10x1t		1
5-30	MZ317068	Amp. Switch Cam B	MR-243	1
5-31	ZW413201	Screw, pan head 4x8		1
5-32	MZ217686	Pause Lever Cushion	LC-102	1
5-33x	BL480150	Switch Lever Block Comp.	1.E	1
5-34	ML488744	Rec. Lever C, w/shaft B	1.E-2002	1
5-35	MR269728	Cam Roller D12.5	RC-156	1
5-36x	ZW290283	'U' Ring 2.85M	6-1-1	1
5-37	ZG227564	Spring H	900-120	1
5-38	ZW290183	'U' Ring 2.85M	6-1-1	1
5-39	SL493042	Rec. Wire B	LE-9028	1
5-40	ZG227485	Spring E	900-119	1

When ordering parts, please describe Parts Number, Serial Number, and Model Number in detail.

FIG. 6 ILLUSTRATION OF MECHANISM ASSEMBLY BLOCK

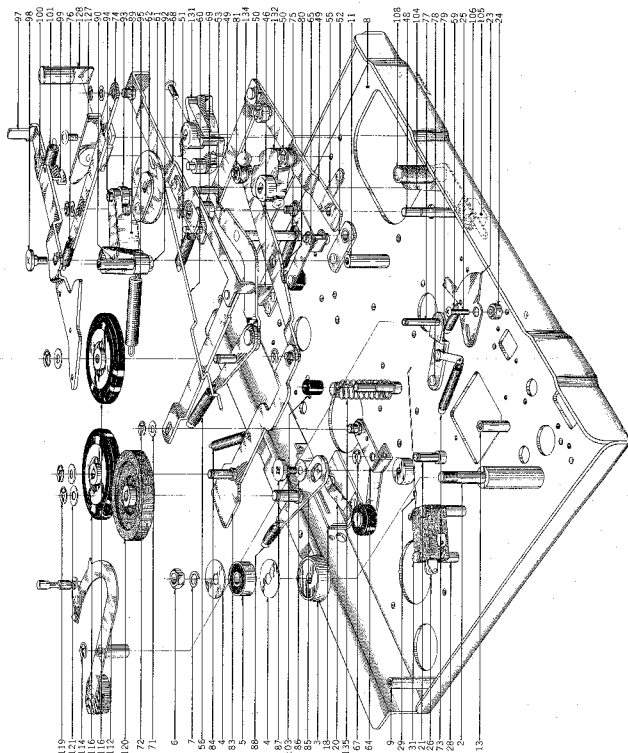

MECHANISM ASSEMBLY BLOCK

Ref. No.	Parts No.	Description	Schematic No.	Q'ty
TAPE GUIDE BLOCK				
6-1X	BZ400948	Tape Guide Block #4 Comp.	MEFASAC	1
6-2	MZ204311	Tape Guide Prop #1700	AT-16	1
6-3	SZ465377	Tape Guide Table A	LC-618	1
6-4	ZW231805	Tape Guide Washer (Large)	AA-356	2

When ordering parts, please describe Parts Number, Serial Number, and Model Number in detail.

Ref. No.	Parts No.	Description	Schematic No.	Q'ty	Ref. No.	Parts No.	Description	Schematic No.	Q'ty
6-5	MV248117	Bearing 635AHZZ-CIE-B32		1	6-69	ML257196	Lever LC, w/lever E2	LC-308	1
6-6	ZW274048	Nut M5		1	6-70x	ZW201767	Screw, pan head 4x6, w/washer		2
6-7	ZW274026	Spring Washer M5		1	6-71	ZW259918	Washer (Press Pan) D5.1x10.3x0.25t		4
ASSEMBLY BLOCK					6-72	ZW290283	'U' Ring 2.85M		3
6-8	MZ271776	Mech. Frame LD, w/bush	LD-101	1	6-73	ZG290384	UN Spring D	1033-108	1
6-9	MZ273295	M-9 Mech. Panel Prop	MS-302	4	6-74	ML256983	Lever C2	900-104	1
6-10x	ZW414033	Screw, countersunk head 3x8		4	6-75	ZG274552	Spring D	900-118	1
6-11	MS257051	Lever FA Shaft	900-127	1	6-76	ZG227441	Spring C	900-117	1
6-12x	ZW413267	Flange Nut M4		4	6-77	MZ260662	AS Lever Prop Base, w/prop	47R-236	1
6-13	HZ247511	Head Prop C	900-142	2	6-78	ZW323728	Screw, binding head 3x5		2
6-14x	ZW413201	Screw, pan head 4x8		1	6-79	ZW273767	Earth Lug D3x20L		1
6-15x	ZW414044	Screw, countersunk head 4x8		1	6-80	ML257040	Lever FA, w/pin	900-107	1
6-16x	MH258816	Hexagon Head Prop	LD-102	1	6-81	MZ217203	Cam Roller A (Nylon)	900-153	1
6-17x	MZ410938	Belt Guide Pin	LF-1009	1	6-82x	ZW290283	'U' Ring 2.85M	6-1-2	2
6-18	ML257073	Lever FB Guide Base	MS-103	1	6-83	ML295272	2 Speed Motor Lever F, w/shaft	MS-107	1
6-19x	ZW417150	Screw, pan head 4x6		2	6-84	ZG270358	F.B. Pull Spring	MS-108	1
6-20	ZG257095	Lever FB Vibration Proof Spring	M8-104	1	6-85	ML257163	Lever K, w/shaft	900-111	1
6-21	MS245663	Brake Lever Shaft	900-129	2	6-86	ZW260166	Washer (Nylon) D6.2x13x0.125t		2
6-22x	MZ245485	Brake Lever Pin (AAL, CSA)	MH-138	1	6-87	ZW223233	Fulcrum Screw A	900-135	1
6-23	MZ312524	Shifter Cam	LD-106	1	6-88	ZG227575	Spring I	900-121	1
6-24	MZ312535	Shifter Cam Collar	LD-107	1	6-89	ML242540	Pinch Roller Lever	900-161	1
6-25	ZW393726	Screw, truss head 3x10		1	6-90	MS243404	Pinch Roller Shaft C	47R-102	1
6-26	ES250007	Micro Switch M-3 U/L	ZS-1-6	1	6-91x	ZW259975	Washer (SUP) D5.1x10.3x0.8t		1
6-27x	ER450786	Spark Quencher U/L 0.1x120.400WV (AAL,CEE)	41-1-33	1	6-92	ZW413188	Nut M4		1
6-28	MZ373961	Micro Switch Prop	RCC-129	2	6-93	MR269763	Cam Roller D13	900-154	1
6-29	MZ205817	Actuator JW 560	ZI-1-5	1	6-94	MS217192	Cam Roller Shaft A	900-130	1
6-30x	ZW414055	Screw, binding head 3x30		1	6-95	ZG227417	Spring A	900-115	1
6-31	ZW414066	Screw, binding head 3x25		1	6-96x	ZW376391	Washer (Polyslida) D6.1x 10x0.13t		1
6-32x	ZW273756	Nut M3		1	6-97	ML479957	Pause Lever (LE), w/screw	LE-1001	1
6-33x	ZW273802	Toothed Lock Washer M3		1	6-98	ZW217877	Pause Lever Set Screw	500-136	1
6-34x	ML308564	Belt Vibration Stopper (AAL, CSA)	MH-137	1	6-99	MZ217855	Pause Stopper	500-169	1
6-35x	ZW413188	Nut M4		2	6-100	ZW323728	Screw, binding head 3x5		1
6-36x	MZ425496	Cycle Angle (CEE)	LS-1007	1	6-101	ZG217866	Pause Lever Spring A	900-123	1
6-37x	ZW413201	Screw, pan head 4x8		1	6-102x	ZW259795	Washer (SUP) D4.3x11x0.13t		1
6-38x	ZW330412	Adjust Washer (U) D4x13x0.13t		1	6-103	MZ217686	Pause Lever Cushion	LC-102	1
6-39x	ZW330423	Adjust Washer (U) D4x13x0.25t		1	6-104	MZ217113	Cam Stopper B	RC120	1
6-40x	ZW330434	Adjust Washer (U) D4x13x0.5t		1	6-105	ZW217102	Cam Stopper Insulator Base	900-155	1
6-41x	ZW330445	Adjust Washer (U) D4x13x0.8t		1	6-106	ZW413245	Screw, pan head 4x15		2
6-42x	ZW273881	Earth Lug M4		1	6-107x	ZW413188	Nut M4		2
6-43x	ZW413267	Flange Nut M4		1	6-108	SB258480	Rec. Button (Gray)	900-107	1
6-44x	ZW462835	Washer (PBP) D4.3x11x0.2t		1	6-109x	ZW318532	Cotter Pin 1x6		1
6-45x	ZW462846	Washer (PBP) D4.3x11x0.3t		1	6-110x	MC489870	Counter MP-491-30, w/base	9-1-24	1
6-46	ML475920	New Spring Hook	900-185	1	6-111x	MB410310	Counter Belt	LF-9037	1
6-47x	ZW323728	Screw, binding head 3x5		1	6-112	BL204658	AS Lever Comp. #2		1
6-48	MS260515	A Lever Shaft	900-136	1	6-113x	ZW322525	Washer (PBP) D4.1x7x0.2t		1
6-49	ML309093	Lever B, w/lever D	900-103	1	6-114	ZW290294	'U' Ring 2.85M	6-1-10	1
6-50	MZ217203	Cam Roller A (Nylon)	900-153	2	6-115x	MP204794	Pinch Roller #3	3A-348	1
6-51	ZG469427	Spring B-1	LS-2004	1	6-116	MI204243	Idle Wheel #2		2
6-52	MZ253653	Metal Mt. Part, w/metal	900-174	1	6-117x	ZW260076	Washer (Nylon) D6.1x10x 0.5t		3
6-53	ML270685	G Lever, w/lever HB	900-109	1	6-118x	ZW376391	Washer (Polyslida) D6.1x 10x0.13t		3
6-54x	ZW260054	Washer (SUP) D6.1x10x0.25t		1	6-119	ZW290283	'U' Ring 2.85M	6-1-1	3
6-55	MZ217708	Pause Lever Retaining Metal B	900-170	1	6-120	MI231423	Middle Wheel, w/metal	900-155	1
6-56	ZG227575	Spring I	900-121	1	6-121	ZW260144	Washer (Nylon) D6.1x 10x0.3t		1
6-57x	MZ256814	Rwd. Shaft Spacer	M9-134	2	6-122x	EJ317125	SP TV-Consent-Plug	42-1-6	1
6-58x	ZW202105	Key, binding head 3x5, w/Lug Plate		1	6-123x	EJ311073	3P Mate-N-Lock Cap Housing 1-480305-0 (AAL)	52-1-5	1
6-59	ZG208091	Impedance Arm Spring	RD-289	1	6-124x	EJ373623	Pin Contact-61116-1 (AAL)	52-1-7	3
6-60	ZG312748	Shifter Spoke	LU-108	1	6-125x	MZ396393	Lock Wire Tie 11M/M	32-1-7	2
6-61	MZ293567	Head Lifter Cam A #1630	1630-104	1	6-127	ML226258	Cramp Terminal 1-SD	47R-122	1
6-62	MZ293578	Head Lifter Cam B #1630	1630-105	1	6-128	SB425777	Start Button	MS-1002	1
6-63x	ZW413223	Screw, binding head 3x5, w/washer		1	6-129x	ZW314728	Cotter Pin 1.6x8		1
6-64	ML217934	Supply Brake Comp.	900-113	1	6-130x	ZW425788	Screw, round head 3x4		2
6-65	ML251932	Take-up Brake Comp.	900-114	1	6-131	MZ316956	Cam A-3	MR-242	1
6-66x	ZW259942	Washer (Fiber) D5.1x10.3x0.5t		4	6-132	MZ217293	Cam B-2, without Tap	1630-201	1
6-67	ZW290283	'U' Ring 2.85M	6-1-1	4	6-133x	ZW416687	Screw, binding head 4x8		2
6-68	ML300161	707 Lever A, w/metal	LC-103	1	6-134	MV270066	Steel Ball D=8		1
					6-135	ZG217394	Belt Change Spring B	MR-125	1

When ordering parts, please describe Parts Number, Serial Number, and Model Number in detail.

FIG. 7 PHOTO OF
PRE-AMP. P.C. BOARD (LE-5022)

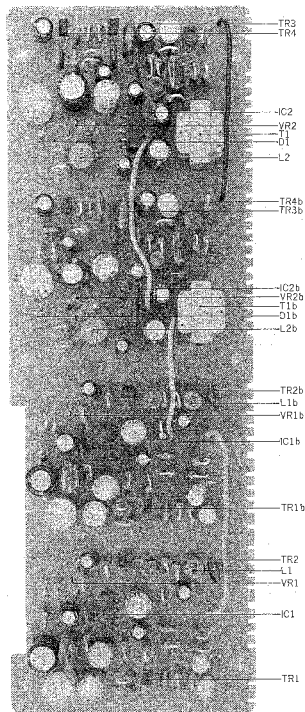

PRE-AMP. P.C. BOARD (LE-5022) BLOCK

Symbol No.	Parts No.	Description	Q'ty
7-1x	BA480251	Pre-amp. P.C. Board Comp. (LE-5022)	1
7-IC1, 2	EI412413	Line Amp. I.C. LD-3141	4
7-TR1	ET352146	Transistor 2SC458LG(D)	2
7-TR2	ET398845	Transistor 2SC871(E) (F)	2
7-TR3, 4	ET234854	Transistor 2SC458LG(C)	4
7-D1	ED219464	Germanium Diode 1N34A	2
7-T1	BT247746	Head Phone Trans. N19-228S	2

Symbol No.	Parts No.	Description	Q'ty
7-L1	EO243977	Ferri Inductor FL7H 1MHG(J)	2
7-L2	EO244001	Ferri Inductor FL9H 10MH(J)	2
7-VR1	EV337577	Semi-fixed Volume V10KS-2-4	2
7-VR2	EV337588	Semi-fixed Volume V10KS-2-4	2
		2 kB	2
		20 kB	2
		Capacitor, Vertical Type	
7-C1	EC432810	Elect. 10pF 16WV(NL)	2
7-C2	EC290520	VFM 100PF(J) 50WV	2
7-C3	EC220364	Elect. 100pF 6.3WV	2
7-C4	EC493323	Elect. 1pF 25WV(NL)	2
7-C5	EC476965	Elect. 47pF 25WV(NL)	2
7-C6	EC220678	Elect. 47pF 25WV	2
7-C7	EC290520	VFM 100PF(J) 50WV	2
7-C8	EC320051	Elect. 10pF 16WV	2
7-C9	EC220364	Elect. 100pF 6.3WV	2
7-C10	EC446297	Mylar 0.18pF(J) 50WV	2
7-C11	EC220364	Elect. 100pF 6.3WV	2
7-C12	EC368335	Mylar 0.022pF(J) 50WV	2
7-C13	EC220994	Elect. 10pF 25WV	2
7-C14	EC320051	Elect. 10pF 16WV	2
7-C15	EC368335	Mylar 0.022pF(J) 50WV	2
7-C16	EC423562	VFM 470PF(J) 50WV	2
7-C17	EC450527	Elect. 4.7pF 25WV	2
7-C18	EC336216	VFM 330PF(J) 50WV	2
7-C19	EC480071	Elect. 22pF 16WV(NL)	2
7-C20	EC336216	VFM 330PF(J) 50WV	2
7-C21	EC476965	Elect. 47pF 25WV(NL)	2
7-C22	EC329771	Elect. 47pF 6.3WV	2
7-C23	EC379170	Mylar 0.1pF(J) 50WV	2
7-C24	EC379787	Mylar 0.0039pF(J) 50WV	2
7-C25	EC389485	Mylar 0.018pF(J) 50WV	2
7-C26	EC290520	VFM 100PF(J) 50WV	2
7-C27	EC329771	Elect. 47pF 6.3WV	2
7-C28	EC450527	Elect. 4.7pF 25WV	2
7-C29	EC220678	Elect. 47pF 25WV	2
7-C30	EC450527	Elect. 4.7pF 25WV	2
7-C31	EC329850	VFM 220PF(J) 50WV	2
7-C32	FC329771	Elect. 47pF 6.3WV	2
7-C33	EC220364	Elect. 100pF 6.3WV	2
7-C34	EC329850	VFM 220PF(J) 50WV	2
7-C35	EC350684	Elect. 22pF 25WV	2
7-C36	EC320051	Elect. 10pF 16WV	2
		Resistor, Stopper Type	
7-R1	ER349907	Carbon RD1/4 33k(J)	2
7-R2	ER414303	Carbon RD1/4 220k(J) (NL)	2
7-R3	ER306360	Carbon RD1/4 6.8k(J)	2
7-R4	ER480060	Carbon RD1/4 33k(J) (NL)	2
7-R5	ER211465	Carbon RD1/4 1k(J)	2
7-R6	ER213030	Carbon RD1/4 5.6k(J)	2
7-R7	ER346601	Carbon RD1/4 47k(J)	2
7-R8	ER212883	Carbon RD1/4 4.7k(J)	2
7-R9	ER346601	Carbon RD1/4 47k(J)	2
7-R10	ER380711	Carbon RD1/4 220k(J)	2
7-R11	ER346994	Carbon RD1/4 18k(J)	2
7-R12	ER336442	Carbon RD1/4 10k(J)	2
7-R13	ER212264	Carbon RD1/4 22k(J)	2
7-R14	ER336442	Carbon RD1/4 10k(J)	2
7-R15	ER342933	Carbon RD1/4 27k(J)	2
7-R16	ER363644	Carbon RD1/4 560(J)	2
7-R17	ER213200	Carbon RD1/4 680(J)	2
7-R18	ER306843	Carbon RD1/4 1.2k(J)	2
7-R19	ER336442	Carbon RD1/4 10k(J)	2
7-R20	ER362485	Carbon RD1/4 330k(J)	2
7-R21	ER212681	Carbon RD1/4 330(J)	2
7-R22	ER347038	Carbon RD1/4 270k(J)	2
7-R23	ER450011	Carbon RD1/4 120k(J)	2
7-R24	ER343078	Carbon RD1/4 2.7k(J)	2
7-R25, 26	FR336442	Carbon RD1/4 10k(J)	4
7-R27	ER357570	Carbon RD1/4 150k(J)	2
7-R28	ER212883	Carbon RD1/4 4.7k(J)	2
7-R29	ER212477	Carbon RD1/4 3.3k(J)	2
7-R30, 31	ER212264	Carbon RD1/4 22k(J)	4
7-R32	ER212883	Carbon RD1/4 4.7k(J)	2
7-R33	ER343078	Carbon RD1/4 2.7k(J)	2

FIG. 8 PHOTO OF OSC., POWER SUPPLY
P.C. BOARD (LE-5021)

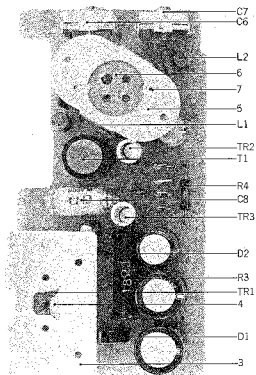

OSC., POWER SUPPLY
P.C. BOARD (LE-5021) BLOCK

Symbol No.	Parts No.	Description	Q'ty
8-1x	BA524823	OSC., Power Supply P.C. Board Comp. (LE-5021)	1
8-2x	BA480306	OSC., Power Supply P.C. Board Comp. (LE-5011) (Deck)	1
8-TR1	ET476886	Transistor 2SC1098(L) (M)	1
8-TR2, 3	FT304255	Transistor 2SC971(2) (3) (red)	2
8-D1	ED329130	Silicon Diode 10DC-1(black)	1
8-D2	FD511918	Zener Diode WZ-240	1
8-T1	EO383365	OSC. Coil OT-204	1
8-L1, 2	EO321254	Ferri Inductor FL7H 5.6MH(J)	2
8-3	EZ480396	Heat-sink Plate	1
8-4	ZW413155	Screw, binding head 3x6	3
8-5	FZ480418	Socket Table	1
8-6	EJ374027	4P Socket	1
8-7	ZW447772	Tapping Screw #2 3x6(BR)	2
Capacitor, Vertical Type			
8-C1, 2	EC337533	Elect. 220 μ F 50WV	2
8-C3	EC313121	Elect. 220 μ F 25WV	1
8-C4, 5	EC350717	VFM 390PF(J) 50WV	2
8-C6, 7	EC425250	Trimmer A-1P3-3 70PF	2
8-C8	EC520492	Styrol 5600PF(J) 500WV (Tab. type)	1
8-C9	EC220678	Elect. 47 μ F 25WV	1
8-C10, 11	EC250841	Mylar 0.01 μ F(J) 50WV	2
8-C12	EC350875	Mylar 0.001 μ F(J) 50WV	1
8-C13	EC220994	Elect. 10 μ F 25WV	1
Resistor, Stopper Type			
8-R1	ER212883	Carbon RD1/4 4.7k(J)	1
8-R2	ER361642	Carbon RD1/4 47(J)	1
8-R3	FR413717	Wire-wound 3WL 18(J) (L type)	1
8-R4	ER298856	Metal Oxide Film 1W 100(K)	1
8-R5	ER212883	Carbon RD1/4 4.7k(J)	1
8-R6-	ER304402	Carbon RD1/4 470(J)	1
8-R7, 8	ER315944	Carbon RD1/4 3.3(J)	2

When ordering parts, please describe Parts Number, Serial Number, and Model Number in detail.

FIG. 9 PHOTO OF MAIN AMP. BLOCK

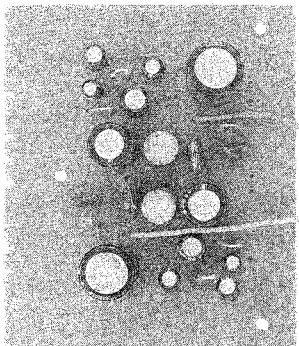
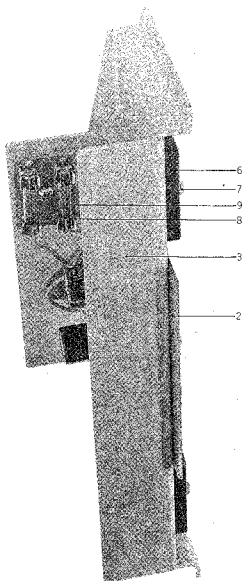

MAIN AMP. BLOCK

Symbol No.	Parts No.	Description	Qty
MAIN AMP. BLOCK			
9-1x	BA490151	Main Amp. Block Comp.	1
9-2	BA490173	Main Amp. P.C. Board Comp. (LE-5213)	1
9-3	EZ489396	Heat-sink Plate	1
9-4x	ZW447840	Tapping Screw #2 3x8(BR)	3
9-5x	ZW273802	Toothed Lock Washer M3	2
9-6	F1372126	L.C. STK-011(A)	2
9-7	ZW447805	Tapping Screw #2 3x12(BR)	4
9-8	EJ338062	2P Fuse Holder B	1
9-9	EF435036	Fuse ST-4 0.9A	2
MAIN AMP. P.C. BOARD (LE-5213) BLOCK			
9-2	BA490173	Main Amp. P.C. Board Comp. (LE-5213)	1
Capacitor, Vertical Type			
9-C301	FC331705	Elect. 22 μ F 16WV	2
9-C302	EC220994	Elect. 10 μ F 25WV	2
9-C303	EC220105	Elect. 100 μ F 10WV	2
9-C304	EC131121	Elect. 220 μ F 25WV	2
9-C305	EC220678	Elect. 47 μ F 25WV	2
9-C307	FC450281	Elect. 0.47 μ F 50WV	2
9-C308	EC450270	Elect. 1000 μ F 25WV	2
9-C309	EC251190	Mylar 0.056 μ F(K) 50WV	2
9-C310	EC379170	Mylar 0.1 μ F(I) 50WV	2
Resistor, Stopper Type			
9-R301	ER361642	Carbon RD1/4 47(J)	2
9-R302	ER346544	Carbon RD1/4 3k(J)	2
9-R303	ER399723	Carbon RD1/4 4.7(J)	2

When ordering parts, please describe Parts Number, Serial Number, and Model Number in detail.

FIG. 10 PHOTO OF AMPLIFIER ASSEMBLY BLOCK

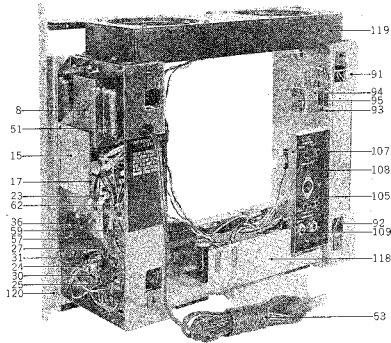
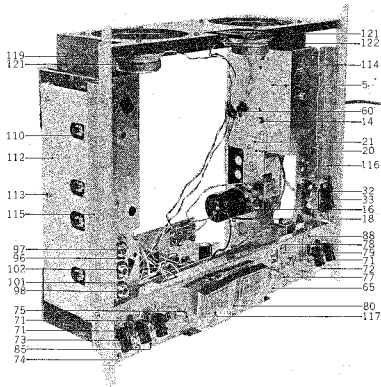

AMPLIFIER ASSEMBLY BLOCK

Ref. No.	Parts No.	Description	Schematic No.	Q'ty	Ref. No.	Parts No.	Description	Schematic No.	Q'ty
		POWER SUPPLY FRAME BLOCK							
10-1x	BZ490162	Power Supply Frame Block Comp.		1	10-4x	BZ480295	Power Supply Frame Block Comp. (CEE)		1
10-2x	BZ480262	Power Supply Frame Block Comp. (Deck)		1	10-5	EZ494853	Power Supply Frame C	L.E-5009	1
					10-6x	EZ479992	Power Supply Frame A (D)	L.E-5009	1
10-3x	BZ480284	Power Supply Frame Block Comp. (CSA)		1	10-7x	EZ480003	Power Supply Frame B (CSA, CEE)	L.E-5009	1
					10-8	BT489813	Power Trans. LET-5	38-4-178	1

When ordering parts, please describe Parts Number, Serial Number, and Model Number in detail.

INDEX

Parts No.	Ref. No. & Symbol No.	Parts No.	Ref. No. & Symbol No.	Parts No.	Ref. No. & Symbol No.	Parts No.	Ref. No. & Symbol No.	Parts No.	Ref. No. & Symbol No.
BA480251	7-1x	EC410016	3-27x	ER336442	7-R14	EZ489835	10-65	MT255982	2-42
BA480251	10-110	EC423562	7-C16	ER336442	7-R19	EZ493277	10-30	MT255993	2-44
BA480306	8-2x	EC425250	8-C6, 7	ER336442	7-R25, 26	EZ494853	10-5	MT292386	2-26
BA480306	10-108x	EC425358	8-C1	ER339085	3-R8	EZ515812	10-30	MT293381	2-7
BA490181	9-1x	EC446297	7-C10	ER342933	7-R15	EZ516644	10-50x	MT317463	2-5
BA490181	10-118	EC450270	9-C308	ER343078	7-R24	HE384693	1-18	MT366864	2-3
BA490173	9-2	EC450281	9-C307	ER343078	7-R33	HL223503	1-32	MT438581	2-49x
BA524823	8-1x	EC450527	7-C17	ER345712	10-82x	HL223536	1-37	MT438592	2-24x
BA524823	10-57	EC450527	7-C28	ER346544	9-R302	HL312941	1-35	MT438603	2-25
BC489993	11-13x	EC450527	7-C30	ER346601	7-R7	HP375131	1-11	MT438614	2-2x
BC490015	11-12	EC476965	7-C5	ER346601	7-R9	HR475446	1-15	MT438636	2-31
BF205075	4-5x	EC476965	7-C21	ER346994	7-R11	HZ247511	6-13	MT438647	2-22
BF244473	4-2	EC480071	7-C19	ER347038	7-R22	HZ274162	1-3	MT440313	2-30
BH490195	1-1x	EC493323	7-C4	ER349907	7-R1	HZ312895	1-20	MV246117	6-5
BJ490138	10-106x	EC493525	3-26	ER357570	7-R27	HZ390744	1-12x	MV269965	3-6x
BJ490140	10-105	EC520492	8-C8	ER361642	8-R2	HZ438020	1-8	MV269966	3-6x
BL203523	4-14x	ED219664	7-D1	ER361642	9-R301	HZ480073	1-14	MV270066	5-16x
BL204658	6-112	ED329130	8-D1	ER362485	7-R20	HZ480442	1-16	MV270066	6-134
BL480150	5-33x	ED329130	10-49x	ER363644	7-R16	HZ480453	1-19x	MY270055	4-11
BM490217	3-1x	ED511918	8-D2	ER376413	10-36	HZ480475	1-30	MZ204311	6-2
BR490184	2-1x	EF238634	10-41x	ER380711	7-R10	HZ490296	1-2	MZ205817	6-29
BR490206	5-2x	EF277424	10-40x	ER395751	10-122	MB229138	10-62	MZ211113	6-104
BS480352	8-14x	EF357424	11-58x	ER398856	8-R4	MB254158	3-21	MZ217203	5-20
BT247766	7-11	EF375577	7-82x	ER399723	9-R303	MD256601	6-60	MZ223433	6-81
BT480014	10-90x	EF389597	10-47x	ER413717	8-R3	MD259233	10-60	MZ217203	6-81
BT480036	10-10x	EF435036	9-9	ER414303	7-R2	MD259233	10-104x	MZ217293	5-17x
BT480047	10-11x	EF460146	11-59x	ER450011	7-R23	MB410310	6-111x	MZ217293	6-132
BT489813	10-8	EF480892	10-45x	ER450786	6-27x	MC489870	6-110x	MZ217686	5-132
BZ400948	6-1x	EF480903	10-46x	ER480060	7-R4	MH258816	6-16x	MZ217686	6-03
BZ480262	10-2x	EJ371216	9-6	ES250007	6-26	MH412827	1-6	MZ217708	6-55
BZ480284	10-3x	EJ412413	7-IC1, 2	ES257668	1-21	MH489374	10-80	MZ217855	6-99
BZ480295	10-4x	EJ205975	6-126x	ES316934	5-3	MH489385	10-83	MZ225720	5-26
BZ490162	10-1x	EJ205975	10-61x	ES317744	10-25	MQ204423	6-116	MZ244113	4-9x
BZ490230	10-63x	EJ205986	10-23	ES369865	5-4	MI231423	6-120	MZ244340	4-30
BZ490241	10-64x	EJ233370	10-37x	ES375478	10-38x	ML217451	4-15	MZ244620	4-24
BA480576	10-78	EJ255003	10-80x	ES425057	10-108	ML217934	6-64	MZ244631	4-23
EA321313	10-44x	EJ255093	10-86x	ES452443	10-71	ML226258	6-127	MZ245485	6-22x
EC230051	9-C303	EJ256097	10-95	ES453196	10-88	ML243496	6-69	MZ254351	3-5
EC220364	7-C9	EJ254970	10-48x	ES480857	10-33	ML251932	6-65	MZ253113	4-10
EC220364	7-C9	EJ276963	1-27	ES480868	10-34x	ML256903	6-74	MZ283653	6-52
EC220364	7-C11	EJ277108	10-19x	ES489857	10-73	ML257040	6-80	MZ253956	3-9x
EC220364	7-733	EJ297066	10-21	ET234854	7-TR3, 4	ML257118	5-19	MZ254160	3-14
EC220676	7-C6	EJ297843	1-26	ET304255	8-TR2, 3	ML257163	6-85	MZ254182	3-15
EC220678	7-C29	EJ305697	10-67x	ET329146	7-TR1	ML257196	6-89	MZ254241	3-15
EC220678	8-C9	EJ311073	6-123x	ET398845	7-TR2	ML270685	6-53	MZ256814	6-57x
EC220678	9-C305	EJ317125	6-122x	ET476886	8-TR1	ML295727	6-83	MZ257073	6-18
EC220994	7-C13	EJ328364	10-109	EV337577	7-VR1	ML300161	6-68	MZ257591	3-5x
EC220994	8-C13	EJ338062	9-8	EV337588	7-VR2	ML308564	6-34x	MZ258581	5-28
EC220994	9-C302	EJ373623	6-124x	EV432134	10-75	ML309093	6-49	MZ260662	6-77
EC250841	8-C10, 11	EJ373624	10-22x	EV480565	10-77	ML475920	6-46	MZ271776	6-8
EC251190	9-C309	EJ374016	10-97	EV489868	10-76x	ML479957	6-97	MZ273295	6-9
EC290520	7-C2	EJ374027	8-6	EZ223817	10-39x	ML488744	3-34	MZ292364	3-20
EC290520	7-C7	EJ376604	10-98	EZ225180	10-99x	MP204794	6-115x	MZ293567	6-61
EC290520	7-C26	EJ437321	10-67x	EZ235113	10-17	MP204794	11-55	MZ293578	6-62
EC313121	8-C3	EJ480914	10-43x	EZ246936	10-52x	MR251460	2-12	MZ296267	6-6
EC313121	9-C304	EJ388196	10-79	EZ315448	10-55x	MR252044	2-34	MZ312824	4-23
EC320051	7-C8	EM483778	11-117	EZ327047	10-111x	MR252066	2-20	MZ312535	6-24
EC320051	7-C14	EO243977	7-L1	EZ352146	10-87	MR254241	3-10x	MZ317391	6-26
EC320051	7-C36	EO244001	7-L2	EZ354240	10-56x	MR254496	3-17	MZ316945	5-5
EC329771	7-C22	EO321254	8-L1, 2	EZ374894	10-53	MR256094	2-47	MZ316956	5-7x
EC329771	7-C27	EO383365	8-T1	EZ382263	10-51	MR269728	5-35	MZ316956	6-131
EC329771	7-C32	EO390622	1-25	EZ426780	11-36	MR269763	6-93	MZ317068	5-30
EC329850	7-C31	ER111465	7-R5	EZ479992	10-6x	MR300644	3-18	MZ327341	5-18
EC329850	7-C34	ER212654	7-R13	EZ480103	10-7x	MS217492	6-94	MZ327352	5-10
EC331705	9-C301	ER212264	7-R30, 31	EZ480396	8-3	MS238084	6-90	MZ373961	6-26
EC336216	7-C18	ER212477	7-R29	EZ480418	8-5	MS244708	4-3	MZ395144	3-2
EC336216	7-C20	ER212681	7-R21	EZ480598	10-91	MS245463	6-21	MZ395166	3-7
EC337533	8-C1, 2	ER212883	7-R8	EZ480600	10-92	MS255606	2-20	MZ396393	6-125x
EC350684	7-C35	ER212883	7-R28	EZ480756	10-112	MS257051	6-11	MZ410938	6-17x
EC350717	8-C4, 5	ER212883	7-R32	EZ480824	10-24	MS260515	6-48	MZ437804	2-43
EC350875	8-C12	ER212883	8-R1	EZ480846	10-32	MT222366	6-13	MZ446635	4-7
EC353766	10-18	ER212883	8-R5	EZ480982	10-115	MT238598	2-32	MS245296	6-36x
EC368235	7-C12	ER213030	7-R6	EZ480993	10-116	MT252101	2-19x	SB258480	6-108
EC368335	7-C15	ER213300	7-R17	EZ481296	10-15	MT252101	2-40x	SB425777	6-128
EC379157	10-84x	ER213873	10-87x	EZ488957	10-96	MT252112	2-4x	SC489284	11-42
EC379170	7-C23	ER204402	8-R6	EZ489363	10-66x	MT255420	2-8	SC489644	11-8
EC379170	9-C310	ER306360	7-R3	EZ489396	9-3	MT255565	2-10	SE489238	11-22
EC379170	10-83x	ER306843	7-R18	EZ489407	10-88	MT258870	2-18	SE489240	11-23
EC379787	7-C24	ER315944	8-R7, 8	EZ489666	10-94	MT258870	2-39	SE489262	11-37
EC389485	7-C25	ER336442	7-R12	EZ489677	10-107	MT258971	2-21	SE489306	11-24x

INDEX

Parts No.	Ref. No. & Symbol No.	Parts No.	Ref. No. & Symbol No.	Parts No.	Ref. No. & Symbol No.	Parts No.	Ref. No. & Symbol No.	Parts No.	Ref. No. & Symbol No.
SE489317	11-25x	ZW260054	2-16	ZW413188	3-23x				
SE489565	11-19	ZW260054	2-37x	ZW413188	6-35x				
SK314100	11-51	ZW260054	4-20x	ZW413188	6-92				
SK425158	11-53	ZW260054	6-54x	ZW413188	6-107x				
SK475097	11-40	ZW260065	2-17	ZW413188	10-14				
SK475121	11-41	ZW260065	2-38x	ZW413188	11-16x				
SK476584	11-48	ZW260065	2-45	ZW413201	5-8x				
SK490315	11-46	ZW260076	6-117x	ZW413201	6-27				
SL493042	5-39	ZW260133	6-9x	ZW413201	5-31				
SM489295	11-43	ZW260133	5-29	ZW413201	6-14x				
SM489330	11-44x	ZW260144	6-121	ZW413201	6-37x				
SP489251	11-34	ZW260166	5-23x	ZW413223	1-29				
SP489576	11-2x	ZW260166	6-86	ZW413223	3-29				
SP489587	11-4	ZW260166	11-50x	ZW413223	6-63x				
SP489598	11-4x	ZW260245	3-8x	ZW413223	10-59				
SP489600	11-3x	ZW270000	2-46	ZW413245	6-106				
SP490353	11-35x	ZW270088	2-11	ZW413267	6-12x				
SS495628	10-121	ZW272395	3-24	ZW413267	6-43x				
SZ276816	11-5	ZW272722	10-68x	ZW413278	4-29				
SZ330895	11-7	ZW272722	10-100x	ZW413280	4-34				
SZ377190	11-28x	ZW273688	11-11x	ZW413741	10-51x				
SZ382217	11-17x	ZW273723	1-22	ZW413943	11-38				
SZ382241	11-20x	ZW273734	1-23	ZW413998	4-32				
SZ465377	6-3	ZW273756	1-5	ZW414033	6-10x				
SZ476875	11-56x	ZW273756	6-32x	ZW414044	6-15x				
SZ482152	11-14	ZW273756	10-28x	ZW414055	6-30x				
SZ489227	10-119	ZW273767	6-79	ZW414066	6-31				
UC542520	3-3	ZW273778	1-39	ZW414336	11-39				
ZG206144	1-10	ZW273802	1-4	ZW416687	5-18x				
ZG208091	6-59	ZW273802	6-33x	ZW416687	6-133x				
ZG217337	4-17	ZW273802	9-5x	ZW417025	1-7				
ZG217394	4-19x	ZW273881	6-42x	ZW417025	1-28				
ZG217394	6-135	ZW273881	10-29x	ZW417137	10-113				
ZG217866	11-101	ZW273881	10-103x	ZW417150	4-31				
ZG227417	6-95	ZW273882	5-24x	ZW417150	6-19x				
ZG227428	10-27	ZW273914	4-26x	ZW417227	11-9x				
ZG227441	6-76	ZW273914	10-13x	ZW419646	11-15x				
ZG227452	6-75	ZW273960	5-25	ZW419646	11-29x				
ZG227485	5-40	ZW274026	6-7	ZW424056	3-16				
ZG227542	2-35	ZW274048	6-6	ZW424056	3-22				
ZG227553	2-14	ZW290248	10-114	ZW424056	4-25x				
ZG227564	5-37	ZW290283	4-21x	ZW424124	11-6x				
ZG227575	6-56	ZW290283	5-21x	ZW424124	11-26x				
ZG227575	6-88	ZW290283	5-36x	ZW425788	6-130x				
ZG227586	5-11	ZW290283	5-38	ZW427037	3-11				
ZG255633	2-9	ZW290283	6-67	ZW433001	11-52x				
ZG257095	6-20	ZW290283	6-72	ZW434160	2-33				
ZG270358	6-84	ZW290283	6-52x	ZW434160	11-47x				
ZG290384	6-73	ZW290283	6-119	ZW434171	2-48				
ZG312748	6-60	ZW290294	6-114	ZW434193	5-15x				
ZG312928	1-33	ZW293027	4-12	ZW434215	5-14x				
ZG434092	2-29	ZW300655	3-19	ZW434250	10-12x				
ZG469427	6-51	ZW312693	2-28	ZW434283	11-30x				
ZW200474	3-25	ZW314728	6-129x	ZW447208	4-5				
ZW201150	11-45x	ZW318532	6-195x	ZW447772	2-7				
ZW201183	11-33x	ZW322525	6-113x	ZW447772	10-16				
ZW201767	6-70x	ZW323728	1-17	ZW447772	10-74				
ZW201778	5-13	ZW323728	1-31	ZW447772	10-93				
ZW202105	6-58x	ZW323728	6-47x	ZW447772	10-120				
ZW202138	5-6x	ZW323728	6-78	ZW447805	9-7				
ZW207314	10-31	ZW323728	6-100	ZW447840	9-4x				
ZW217102	6-105	ZW323728	10-35x	ZW454860	10-69x				
ZW217877	5-22	ZW324448	11-18x	ZW455275	10-101				
ZW217877	6-98	ZW330412	6-38x	ZW461935	10-26x				
ZW223233	6-87	ZW330423	6-39x	ZW462835	6-44x				
ZW231693	2-23	ZW330434	6-40x	ZW462846	6-45x				
ZW231794	4-28x	ZW330445	6-41x	ZW464714	1-9				
ZW231805	6-84	ZW336846	1-34	ZW467671	11-21x				
ZW23588	4-31	ZW373575	6-25	ZW477876	1-75				
ZW244574	4-27	ZW376391	6-96x	ZW480622	1-36				
ZW244710	4-8	ZW376391	6-118x	ZW481072	11-54x				
ZW252977	4-13x	ZW384131	3-4x	ZW481454	11-57x				
ZW253405	11-49x	ZW391680	10-70x	ZW489745	11-10				
ZW254621	3-12	ZW391680	10-102	ZW490116	10-89x				
ZW259795	6-102x	ZW393323	4-33	ZW490127	10-90x				
ZW259918	6-71	ZW393726	6-25	ZW490364	11-27x				
ZW259942	6-66x	ZW408418	11-31						
ZW259975	6-91x	ZW411660	11-32						
ZW260021	2-15	ZW413155	1-38						
ZW260021	2-36	ZW413155	5-4						

SECTION 3

SCHEMATIC DIAGRAM

1. 4400 SCHEMATIC DIAGRAM
2. 4400D SCHEMATIC DIAGRAM

4400D

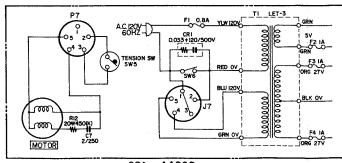
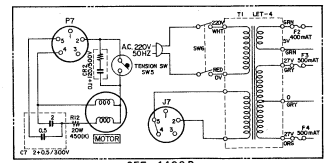
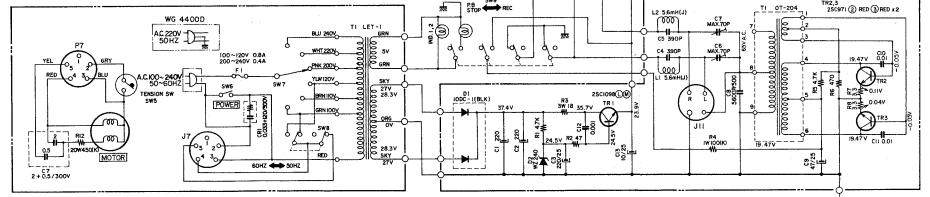
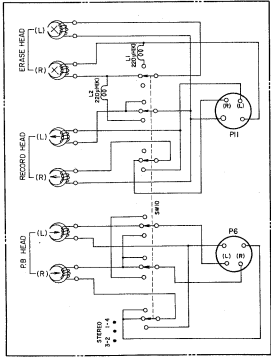
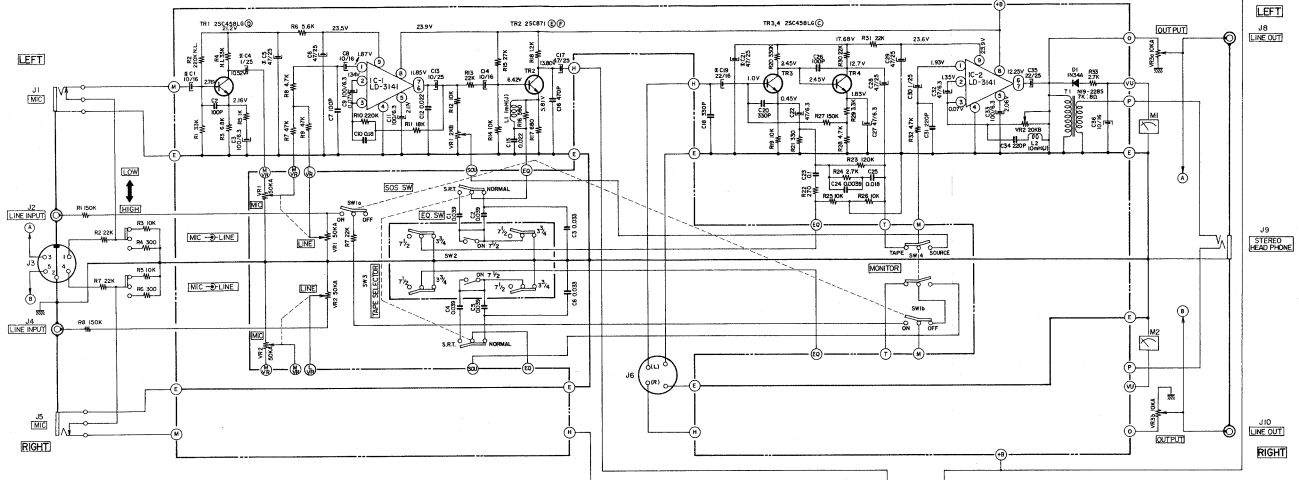

NOTE
UNLESS OTHERWISE SPECIFIED
ALL RESISTORS IN Ω (10K Ω)
ALL CAPACITORS IN μF (500V μ)
MARK INDICATES LOW LEAKAGE CAPACITORS

CEE 4400D

CSA 4400D

4400D SCHEMATIC
DIAGRAM No.2-2 1460656A

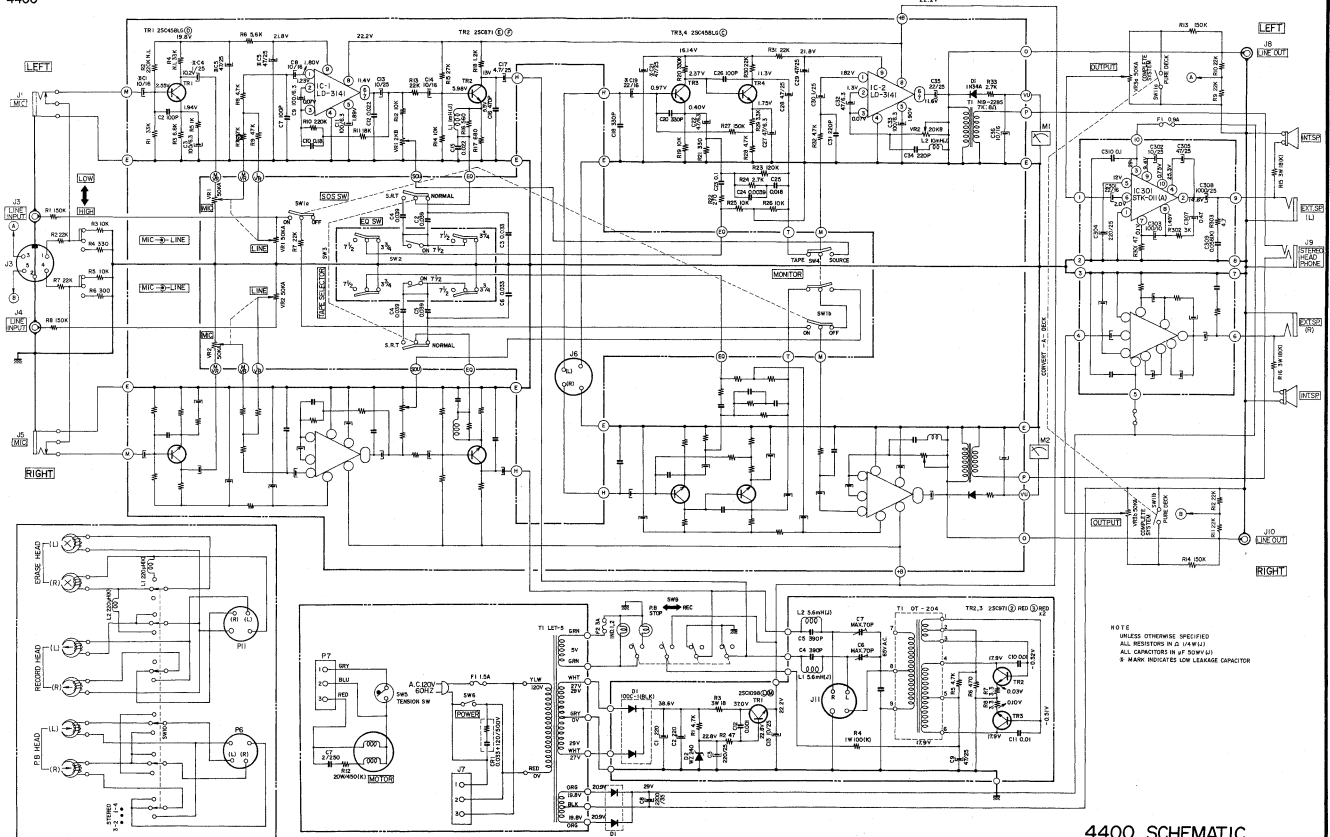

NOTE
 DIMENSIONS OTHERWISE SPECIFIED
 ALL RESISTORS IN Ω (4W/1)
 ALL CAPACITORS IN µF (50WV/1)
 ♯ MARK INDICATES LOW LEAKAGE CAPACITOR

4400 SCHEMATIC
 DIAGRAM No.2-1 1460657A