

4000D

THREE-HEAD
STEREO TAPE DECK
OPERATOR'S MANUAL

THREE-HEAD
ALL SILICON TRANSISTORIZED
PRE-AMPLIFIER



AKAI®

TABLE OF CONTENTS

I GENERAL INFORMATION

1. Specifications	1
2. Controls	2
3. Voltage and Cycle Conversion	4
4. Tape Speed Selection	5
5. 4-Track Recording/Playback System	6
6. Tape Cleaner	7
7. Din (One Multiple-Connection) Jack	7
8. Automatic Shut-Off	8
9. Operating Precautions	9

II OPERATING INSTRUCTIONS

1. Tape Loading	10
2. Instant Stop/Pause Control	10
3. Fast Forward and Rewind	10
4. Playback	11
Stereo	
Monaural	
5. Recording	12
Stereo	
Monaural	
From an External Amplifier	
From Another Tape Recorder	
From Discs	
Sound with Sound	
6. Monitoring	17
7. Tape Splicing and Editing	17
8. Tape Erasing	18
9. Head Cleaning	19

10. Head Demagnetizing	21
------------------------------	----

III ACCESSORIES

1. Optional Accessories	22
2. Standard Accessories	23

IV SCHEMATIC

1. SPECIFICATIONS

Tape Speed	: 3-3/4 and 7-1/2 ips	2 diodes
Wow and Flutter	: Less than 0.15% RMS at 7-1/2 ips Less than 0.20% RMS at 3-3/4 ips	2 rectifiers
Frequency Response	: 30 to 22,000 cps ± 3 db at 7-1/2 ips 30 to 16,000 cps ± 3 db at 3-3/4 ips	Power Supply : AC 100 to 240V, 50/60 cycles
Distortion	: Within 2% 1,000 cps 0 VU	Power Consumption : 30VA
Signal to Noise Ratio	: Better than 50 db	Dimensions : 12-3/8" \times 15-7/8" \times 7-1/2" (315 \times 405 \times 180 mm)
Input Level	: Microphone ... more than 0.5 mV Line more than 50 mV	Weight : 25.3 lbs (11.5 kg)
Output Level	: 0VU (1.23 V RMS)	
Equalization	: Correct equalization for playback of tapes recorded to the NARTB curve.	
Recording Level Indicator	: 2 VU meters	
Recording System	: 4-track stereo/monaural system	
Fast Forward and Rewind Time	: 150 seconds using 1,200 foot tape at 50 cycles. 120 seconds at 60 cycles.	
Maximum Recording Time	: 4 hours monaural recording at 3-3/4 ips (1,200 foot recording tape). 2 hours stereo recording at 3-3/4 ips	
Motor	: Induction motor	
Transistor	: 17 silicon transistors	

2. CONTROLS

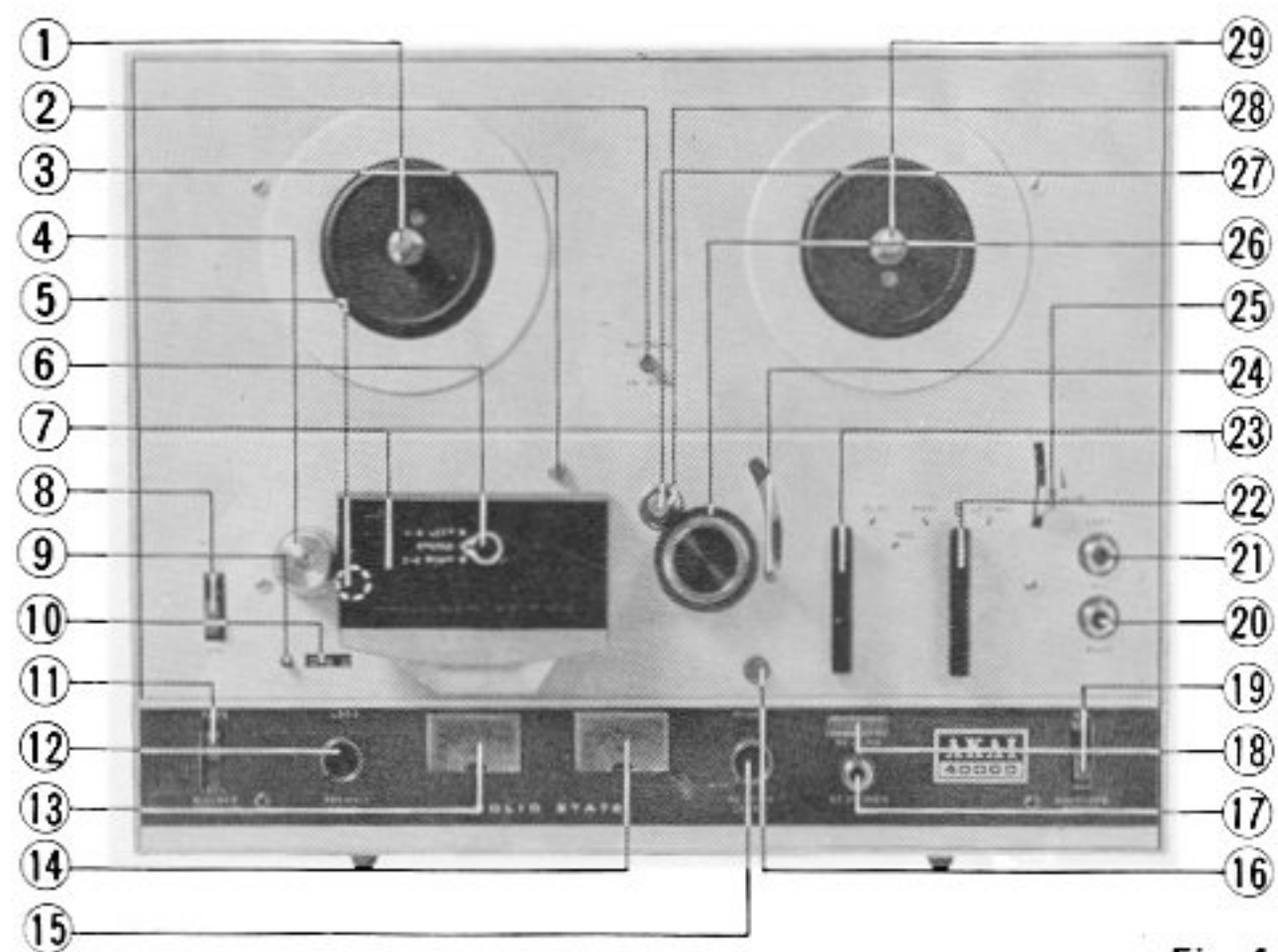

Fig. 1

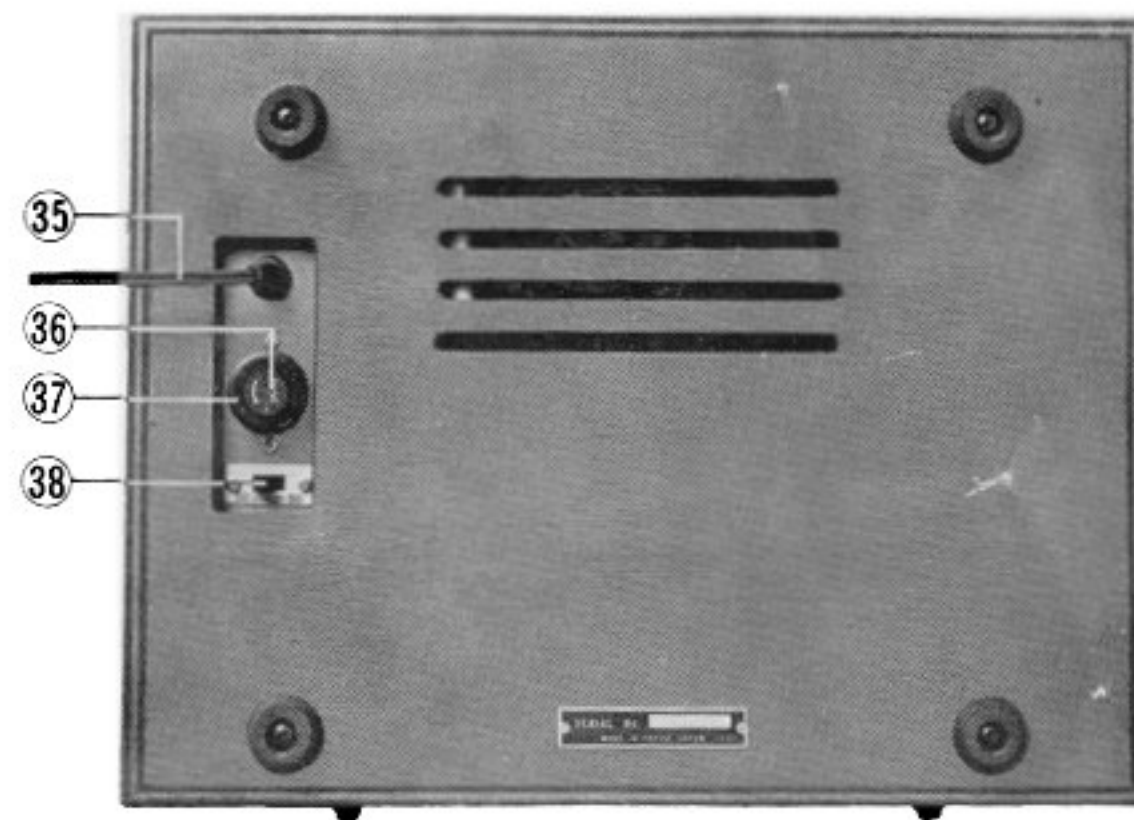

Fig. 2

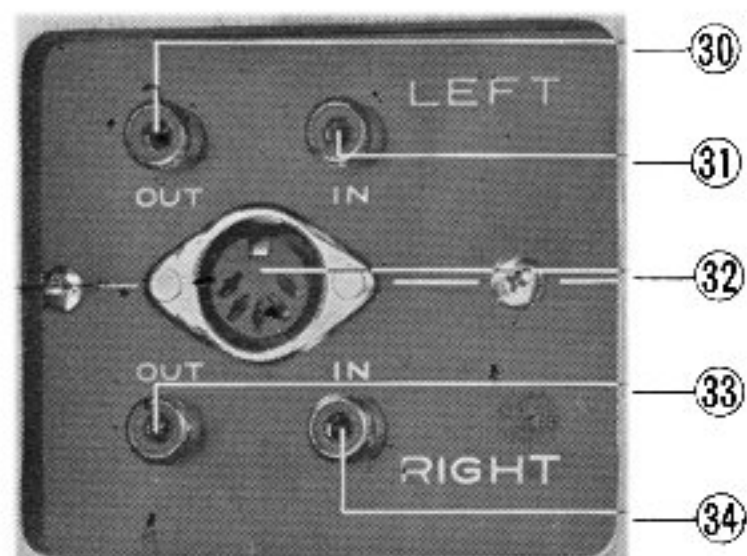

Fig. 3

- | | |
|-----------------------------------|-------------------------------|
| ① Supply Reel Shaft | ⑳ Microphone Jack (Right) |
| ② Cycle Conversion Switch (A) | ㉑ Microphone Jack (Left) |
| ③ Capstan Storage Post | ㉒ Fast Forward/Rewind Lever |
| ④ Tape Guide | ㉓ Record/Playback Lever |
| ⑤ Tape Cleaner | ㉔ Automatic Shut-off Lever |
| ⑥ Track Selector | ㉕ Instant Stop/Pause Lever |
| ⑦ Head Cover | ㉖ Pinch Wheel |
| ⑧ Equalizer Switch | ㉗ Capstan Shaft |
| ⑨ Reset Button | ㉘ Capstan |
| ⑩ Index Counter | ㉙ Take-up Reel Shaft |
| ⑪ Tape/Source Monitor Switch | ㉚ Line Output Jack (Left) |
| ⑫ Record Level Control (Left) | ㉛ Line Input Jack (Left) |
| ⑬ VU Meter (Left) | ㉜ DIN Jack |
| ⑭ VU Meter (Right) | ㉝ Line Output Jack (Right) |
| ⑮ Record Level Control (Right) | ㉞ Line Input Jack (Right) |
| ⑯ Record Safety Button | ㉟ AC Cord |
| ⑰ Stereo Headphone Jack | ㊱ Fuse Post |
| ⑱ Record Indicator Lamp | ㊲ Voltage Selector |
| ⑲ Power/Automatic Shut-off Switch | ㊳ Cycle Conversion Switch (B) |

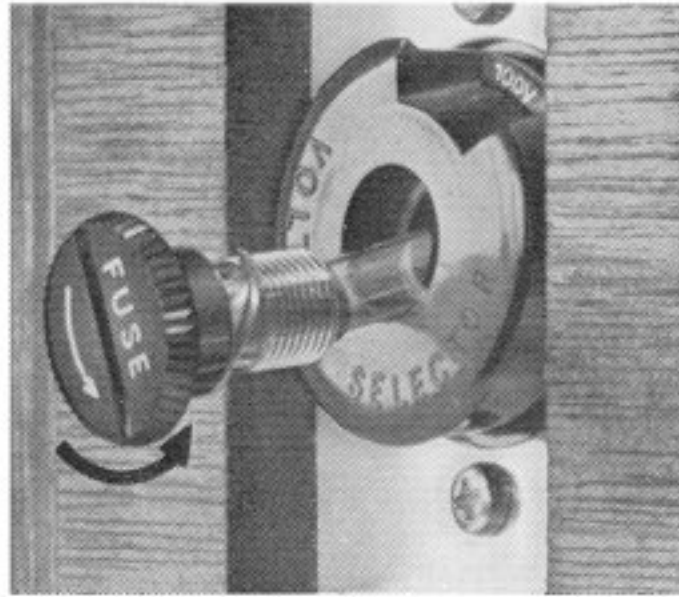

Fig. 4

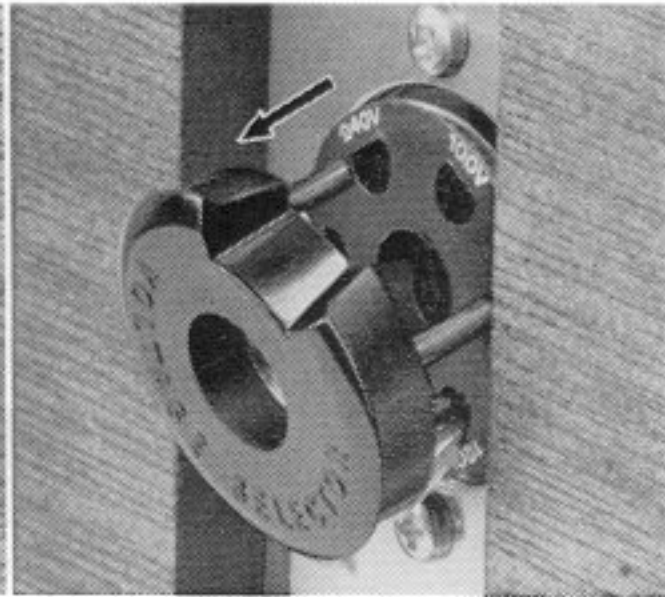

Fig. 5

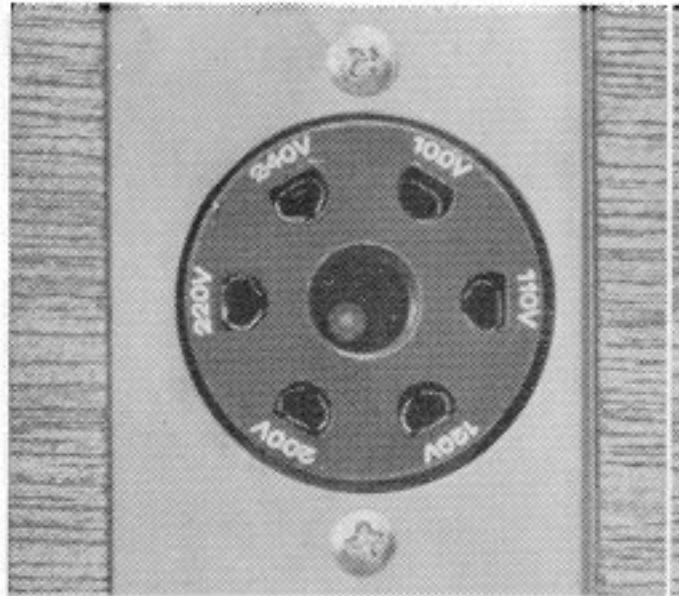

Fig. 6

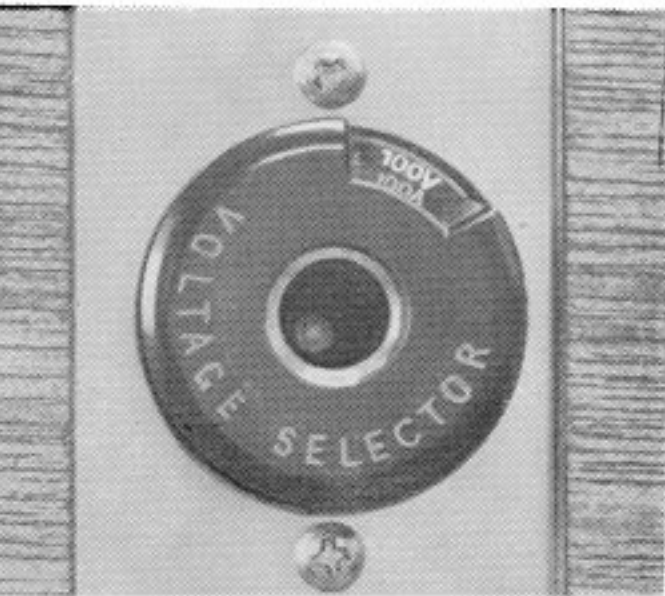

Fig. 7

3. VOLTAGE AND CYCLE CONVERSION

VOLTAGE

The Model 4000D is operatable anywhere in the world. With the built-in stepdown power transformer, the operator can easily readjust the recorder to any one of the six stages of power voltage from 100 to 240 volts A.C. The operator is requested to check the rear of the recorder to determine the previously set voltage before operation.

If another voltage is required, readjustment of the voltage can be made as follows.

- (1) Remove the FUSE POST ③⑧ as shown in Fig. 4. Remove the PLUG of VOLTAGE SELECTOR ③⑦ and reinsert so that the desired voltage appears.
- (2) The VOLTAGE SELECTOR ③⑦ as shown in Figs. 5, 6 and 7 is a rotatable plug-in type offering six selections, 100/110/120/200/220/240.
- (3) Change the fuse according to voltage.

Fuse : 100V-120V 0.8A, 200V-240V 0.4A

CAUTION: Disconnect power plug from the AC outlet before readjusting voltage. To maintain optimum performance and to prolong the life of your machine, it is important that the line voltage be held within 10 percent deviation of standard voltage.

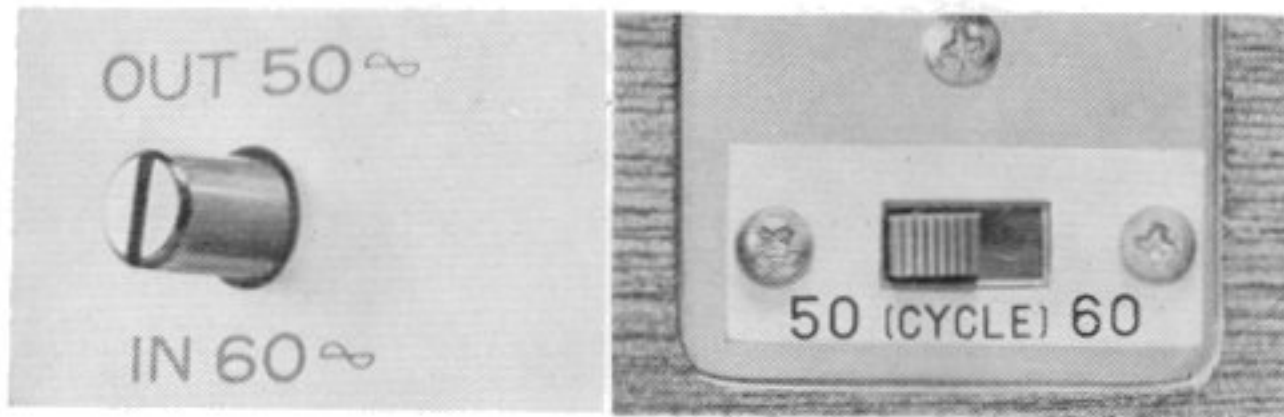

Fig. 8

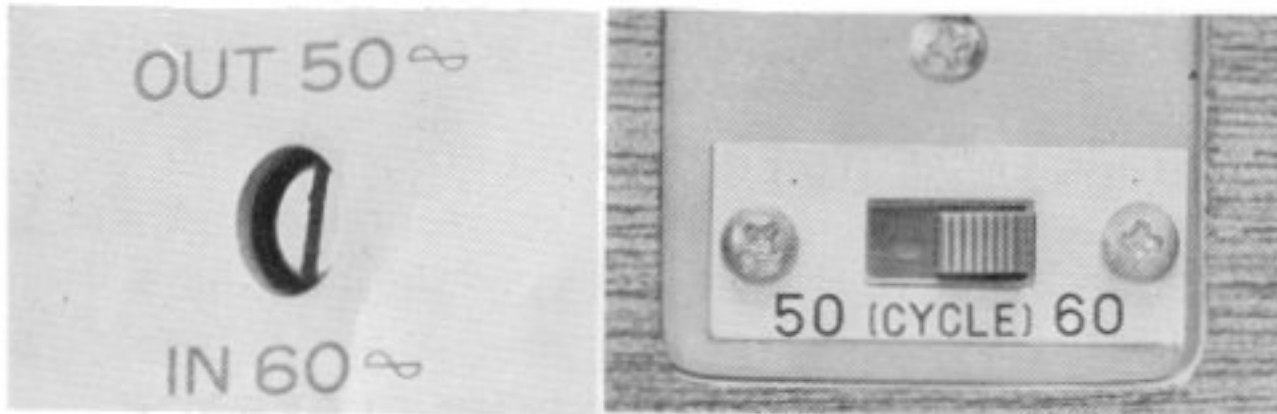
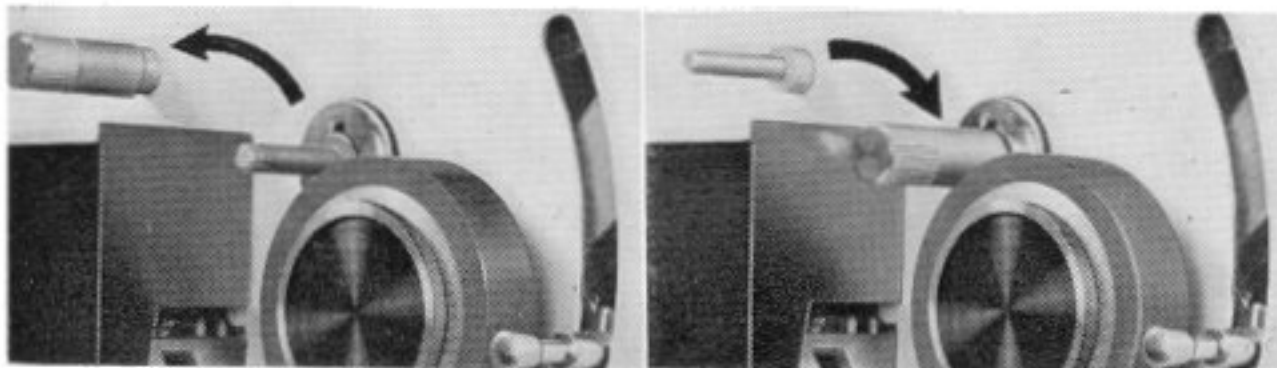

Fig. 9



3-3/4 ips

Fig. 10

7-1/2 ips

Fig. 11

TAPE LENGTH	TAPE SPEED			
	4-TRACK STEREO		4-TRACK MONO	
	3-3/4 ips	7-1/2	3-3/4 ips	7-1/2
1200 ft	2 HRS	1	4	2
1800	3	1.5	6	3
2400	4	2	8	4

CYCLE

Correct tape speed cannot be obtained if the Cycle Conversion Switches are not properly positioned. The CYCLE CONVERSION SWITCH (A) ② is located in the upper center of the top face panel and the CYCLE CONVERSION SWITCH (B) ③ is located in the rear of the recorder. Using a screw driver, rotate the CYCLE CONVERSION SWITCH (A) ② counter clockwise approximately one-eighth of a turn. The switch can then be moved either OUT or IN. 50 cycle operation is obtained by moving the switch OUT (Fig. 8), and 60 cycle operation by moving the switch IN (Fig. 9). The switch ② should be rotated back to its original position after it has been moved either OUT or IN. The CYCLE CONVERSION SWITCH (B) ③ should also be reset.

CAUTION: Do not attempt to rotate the CYCLE CONVERSION SWITCHES when the motor is not running.

4. TAPE SPEED SELECTION

The 4000D usually operates on 2 tape speeds, 7-1/2 and 3-3/4 ips.

Refer to the chart for selection of an adequate tape speed. Tape speed is determined by the CAPSTAN ② on the tape drive capstan shaft.

3-3/4 ips. The CAPSTAN ② is not used but is left on the CAPSTAN STORAGE POST ③.

7-1/2 ips. The CAPSTAN ② is used.

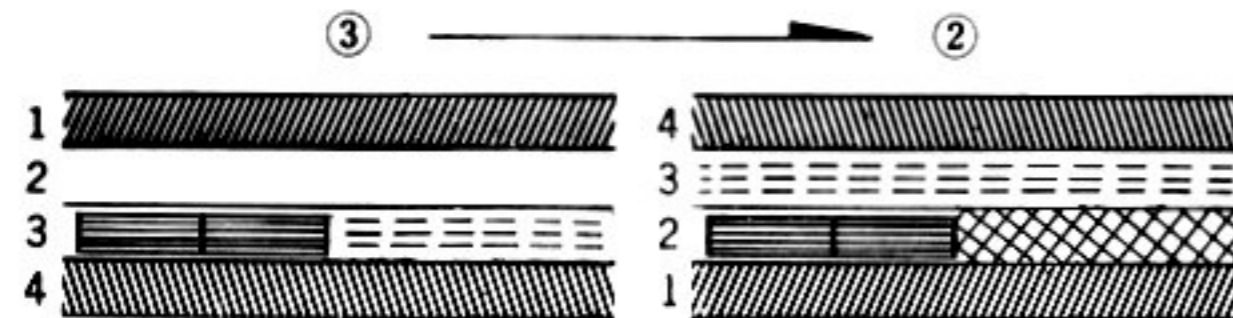
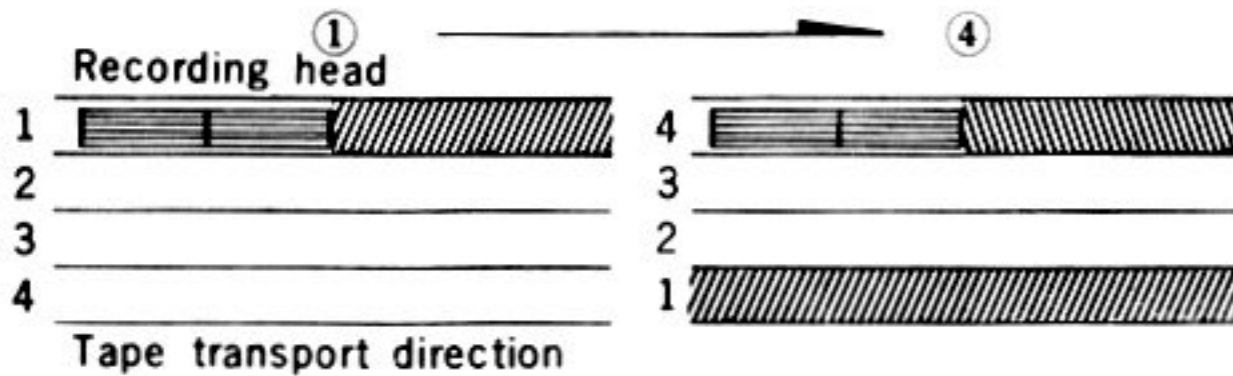
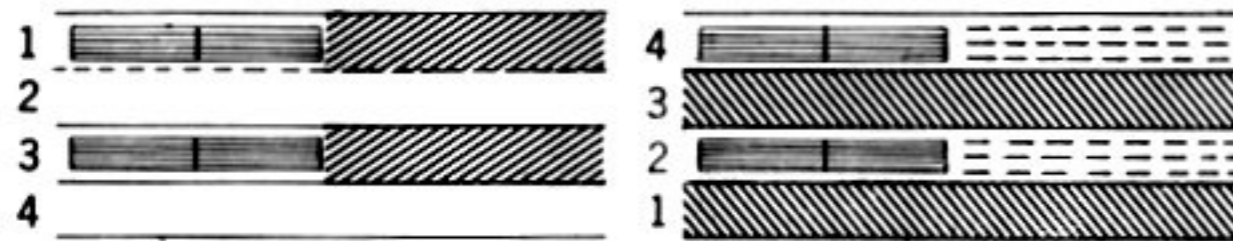
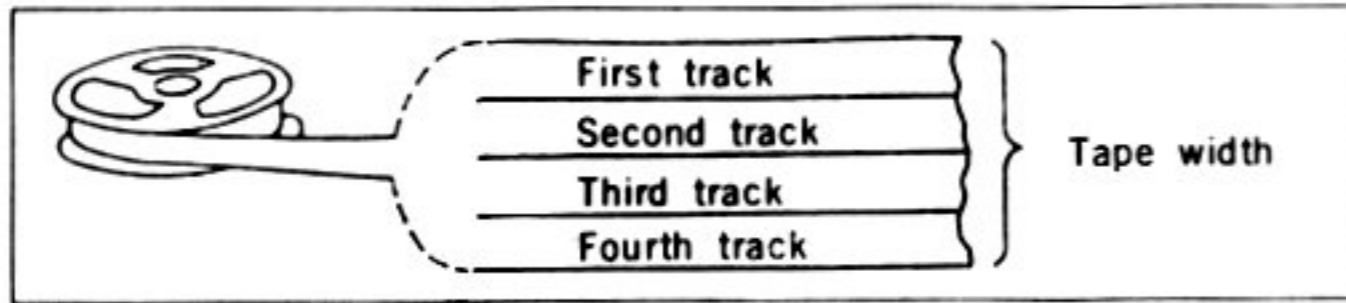

5. 4-TRACK RECORDING/PLAYBACK SYSTEM

The AKAI 4000D employs a four track system which can be used for either stereo or monaural recording/playback. The desired track or tracks are selected by the TRACK SELECTOR ⑥.

4-TRACK STEREO RECORDING/PLAYBACK

Stereo recording/playback requires the simultaneous use of two tracks.

Set the TRACK SELECTOR ⑥ to "STEREO".

The first stereo recording/playback occurs on tracks 1 and 3, and the second on tracks 2 and 4 after the reels have been inverted.

4-TRACK MONAURAL RECORDING/PLAYBACK

Monaural recording/playback track sequence should be 1-4-3-2.

(A) Set the TRACK SELECTOR ⑥ to "1-4". The first monaural recording/playback occurs on track 1, and the second on track 4 after the reels have been inverted.

(B) Invert the reels.

(C) Set the TRACK SELECTOR ⑥ to "3-2".

The third monaural recording/playback occurs on track 3, and the fourth on track 2 after the reels have been inverted.



Fig. 12

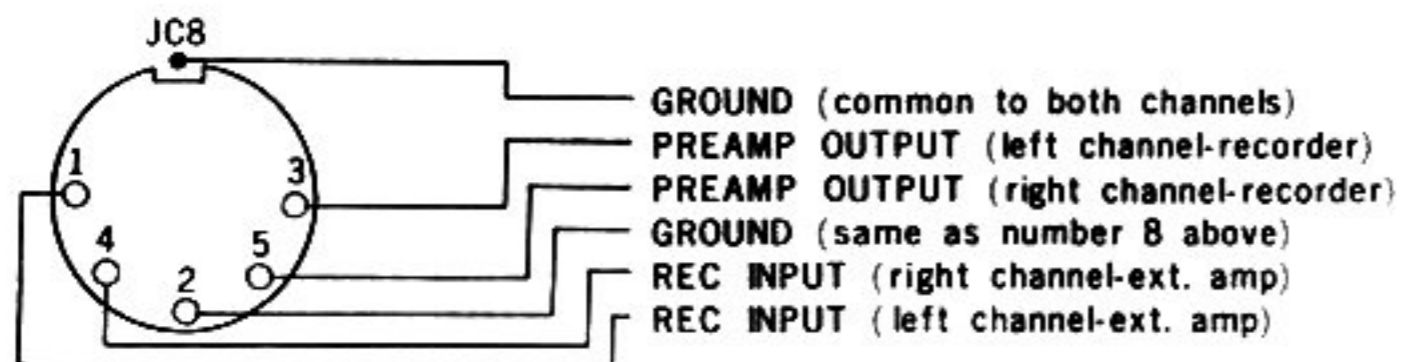

Front View of DIN JACK

6. TAPE CLEANER

A squeaking noise may annoy the operator during recording/playback. This may be caused by either poor tape or ambient conditions of temperature and humidity. When foreign material adheres to the tape it piles up on the recording head affecting volume and sound quality; particularly the high frequency range.

The model 4000D is equipped with a TAPE CLEANER ⑤ Fig. 12, a felt pad properly soaked with silicon oil, to aid in noise elimination and facilitate tape cleaning. When the felt pad is contaminated on one side it may be rotated by loosening the holding screw. Replacement may be made when both sides are contaminated.

7. DIN (ONE MULTIPLE-CONNECTION) JACK

The DIN JACK ③② which is provided at the right side of Model 4000D, and is used for interconnecting Model 4000D with an external stereo amplifier, has a compatible connection jack. This system permits easy recording and playback of stereo programs through an external stereo amplifier. Thus the complex connection or disconnection of more than 4 separate plugs from Model 4000D's panel side is avoided.

If your amplifier is not equipped with the DIN Jack and the use of this one connection system is required, AKAI DR-110 may be used.



Fig. 13

8. AUTOMATIC SHUT-OFF

One of the exclusive features of Model 4000D is the function of the automatic shut-off unit. When the tape ends or is accidentally broken the AUTOMATIC SHUT-OFF LEVER ②④ drops and reel movement stops. To obtain automatic shut-off of the recorder the POWER/AUTOMATIC SHUT-OFF SWITCH ①⑨ must be placed in the "SHUT-OFF" position after turning the RECORD/PLAYBACK LEVER ②③ in "PLAY" position.

NOTE: Automatic Shut-Off only possible during Record/Playback operation.

9. OPERATING PRECAUTIONS

IMPORTANT : READ THE FOLLOWING INSTRUCTIONS CAREFULLY BEFORE OPERATING YOUR MACHINE :

① THE USE OF NEW TAPE WILL RESULT IN THE BEST RECORDINGS.

② THE SYMPTOMS LISTED BELOW DO NOT NECESSARILY INDICATE MECHANICAL FAILURE OF YOUR TAPE DECK. IF YOUR MACHINE EXHIBITS ANY OF THESE SYMPTOMS, CHECK FOR THE TROUBLE AS INDICATED.

(1) Loss of sensitivity and tone quality may be due to :

- A. Dirty erase head. This will prevent prerecorded material from being completely erased.
- B. Dust on the recording head. Clean the head gently with a soft cotton swab soaked in rubbing alcohol or carbon tetrachloride.
- C. A.C. power voltage lower than the standard voltage to which your machine is adjusted.

(2) Irregularity in the tape transport may be due to :

- A. Grime adhering to the heads.
- B. Oil on the capstan.
- C. Sticky or dirty tape surface.
- D. Bent take-up reel.

(3) If your machine will not record, check the following for correct position.

- A. Record/Playback lever.
- B. Input plugs.

(4) If your machine will not playback, check the following for correct position.

- A. Tape/Source monitor switch.

NOTE :

(1) Before operating your machine, be sure to clean the surface of the head.

(2) Unused tape may become soft and sticky. It is advisable to run the tape once from the supply reel to the take-up reel before threading it for recording.

③ THE FOLLOWING NOTES ARE PROVIDED FOR YOUR CONVENIENCE.

(1) If any trouble develops, please take your machine to the nearest authorized agent in your area or inquire at the Service Dept. of the Akai Company in Tokyo, Japan.

(2) Your Akai Tape Deck Model 4000D requires constant voltage for optimum performance.

(3) The standard 1,200 foot length of tape on a 7" reel plays up to 32 minutes at 7-1/2 ips speed in one direction.

(4) If the sound sources are so far away from the microphones that the volume control must be turned up to a maximum, some hum or noise will inevitably be recorded. In such instance, a test recording is recommended before attempting a final recording.

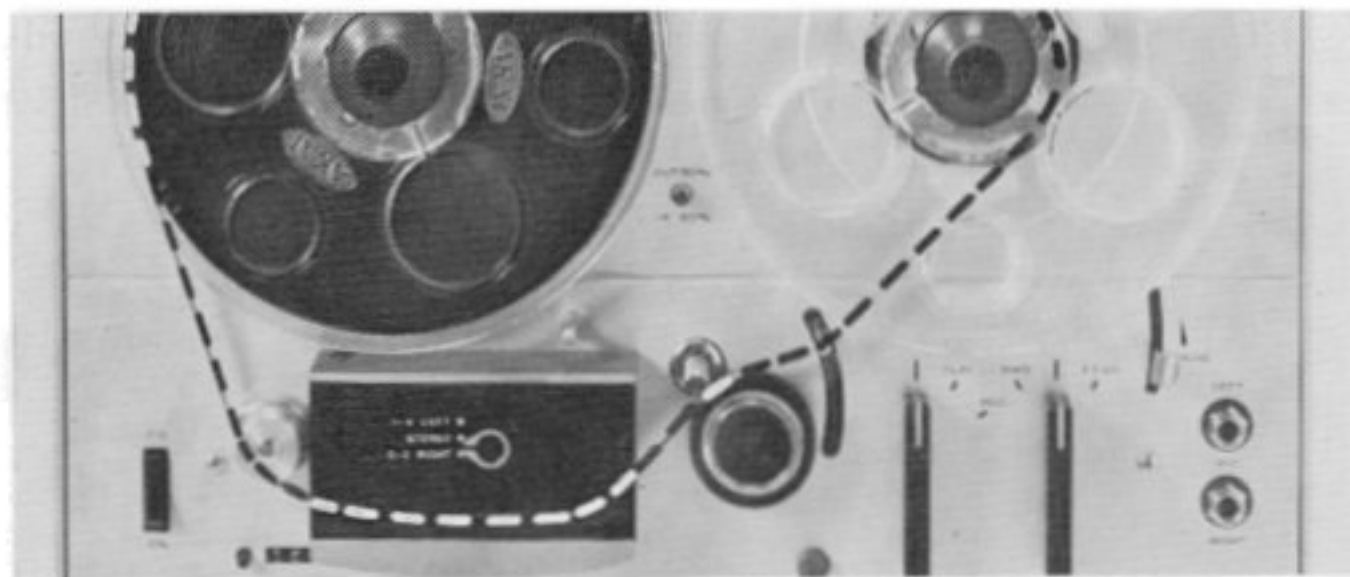

Fig. 14

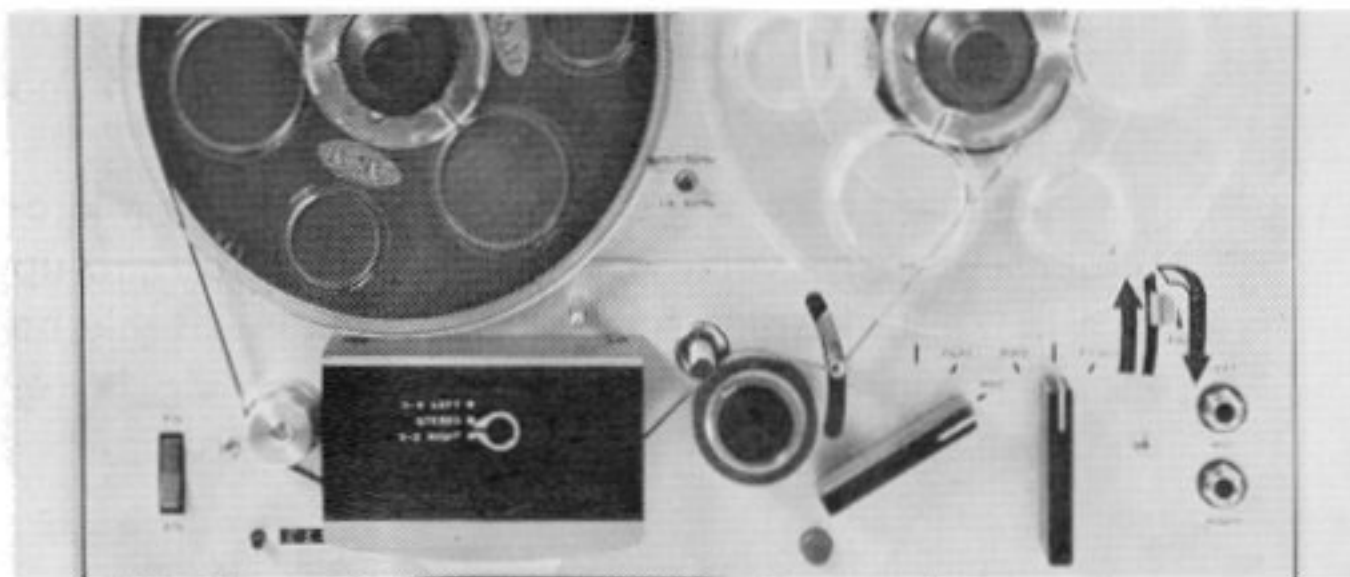

Fig. 15

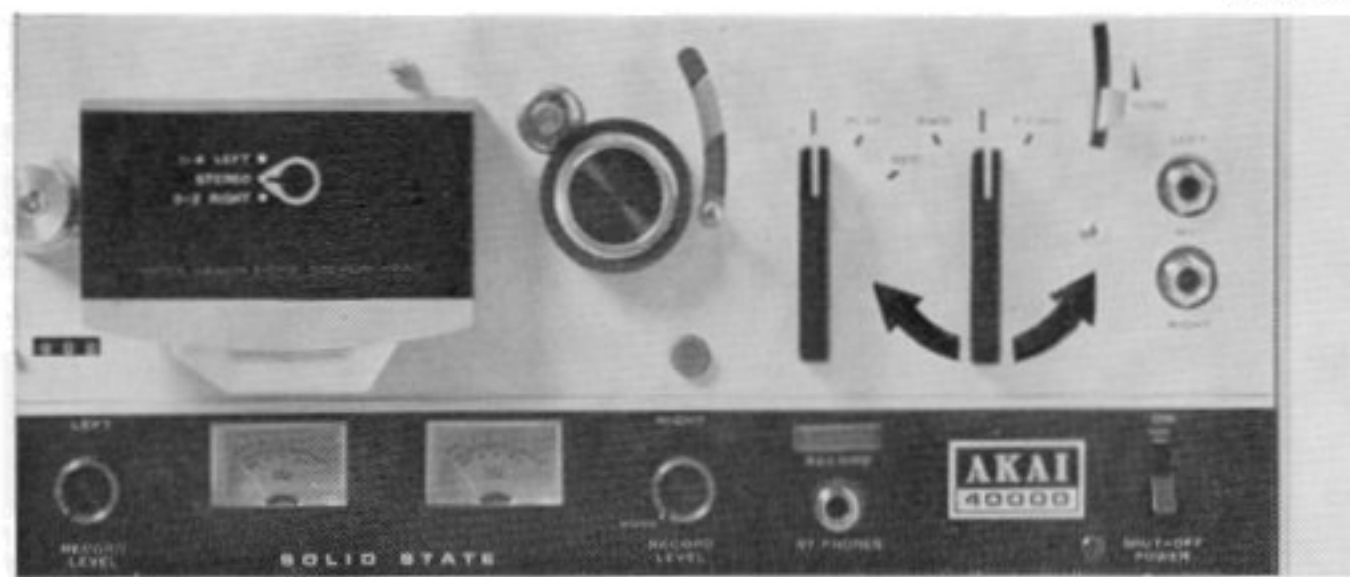

Fig. 16

1. TAPE LOADING

Place the full reel of tape on the SUPPLY REEL SHAFT ① and the empty reel on the TAKE-UP REEL SHAFT ②.

Thread the tape as illustrated by the dotted line in Fig. 14. When the recorder is used in the vertical (recommended) position, rubber caps must be used.

CAUTION: Thread the tape below the AUTOMATIC SHUT-OFF LEVER ④.

2. INSTANT STOP/PAUSE CONTROL

To momentarily stop the tape during record/playback push the INSTANT STOP/PAUSE LEVER ⑤ to the "STOP" position as shown Fig. 15.

The lever will be locked in the stop position and can be released by lifting the curved tip. The INSTANT STOP/PAUSE LEVER ⑤ will not function during fast forward or rewind operating.

Use of the INSTANT STOP/PAUSE LEVER ⑤ permits adjustment and balance of the optimum recording level when the recorder is set to the normal recording mode. Adjust the record level controls while watching the VU meters.

This control may additionally be used, during recording, to edit the tape (e.g. lift the lever to stop the recorder when certain portions of the program are not desired). It is noted that when the lever is released and recording again commences, no annoying switch "click" is impressed on the tape.

3. FAST FORWARD AND REWIND

Fast forward or rewind is performed by turning the FAST FORWARD/REWIND LEVER ⑥ to the proper position. Fast forward or rewind permits rapid selection of recordings on the tape. The FAST FORWARD/REWIND LEVER ⑥ cannot be turned out of the stop position unless the RECORD/PLAYBACK LEVER ③ is in its stop position, and vice-versa.

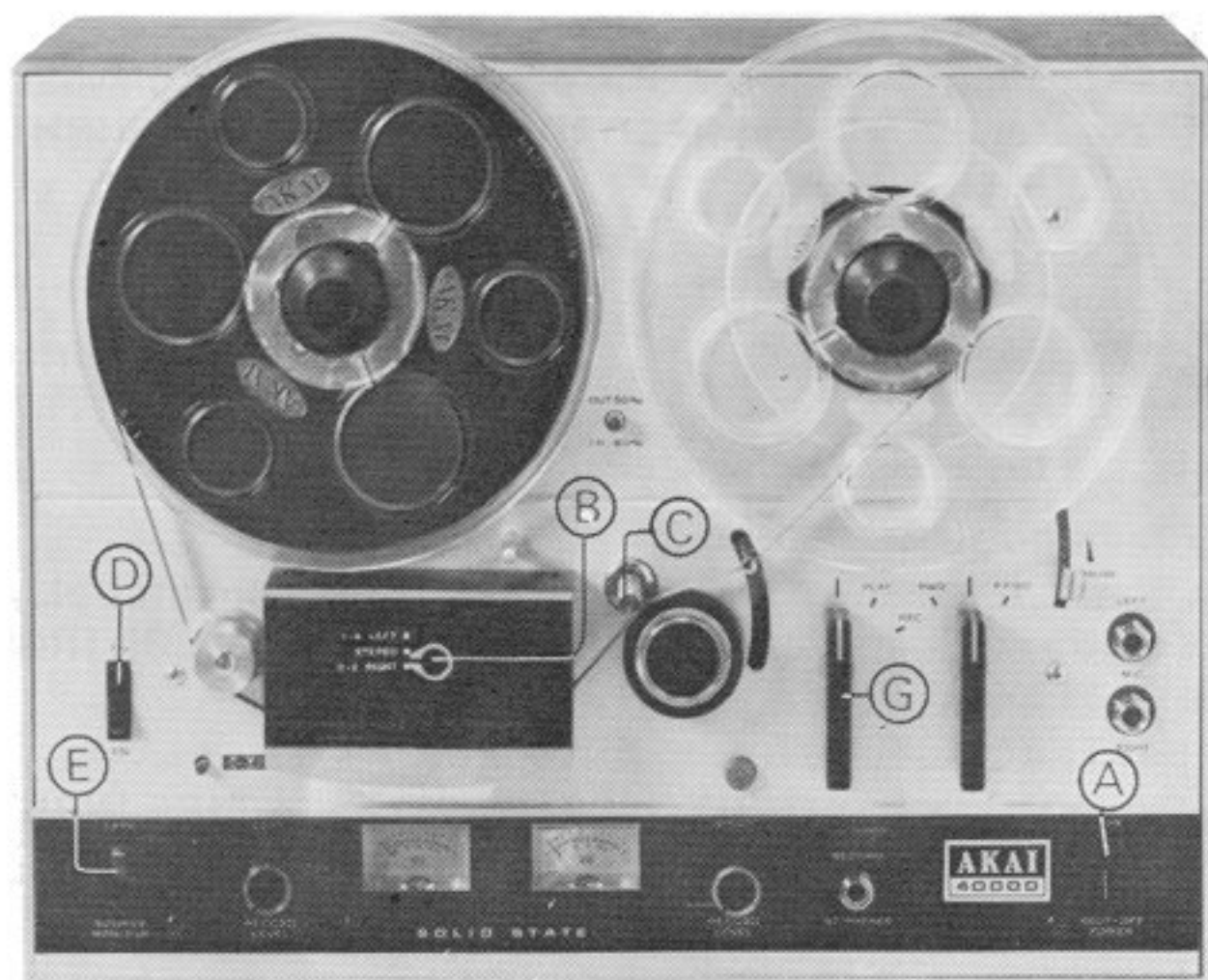

Fig. 17

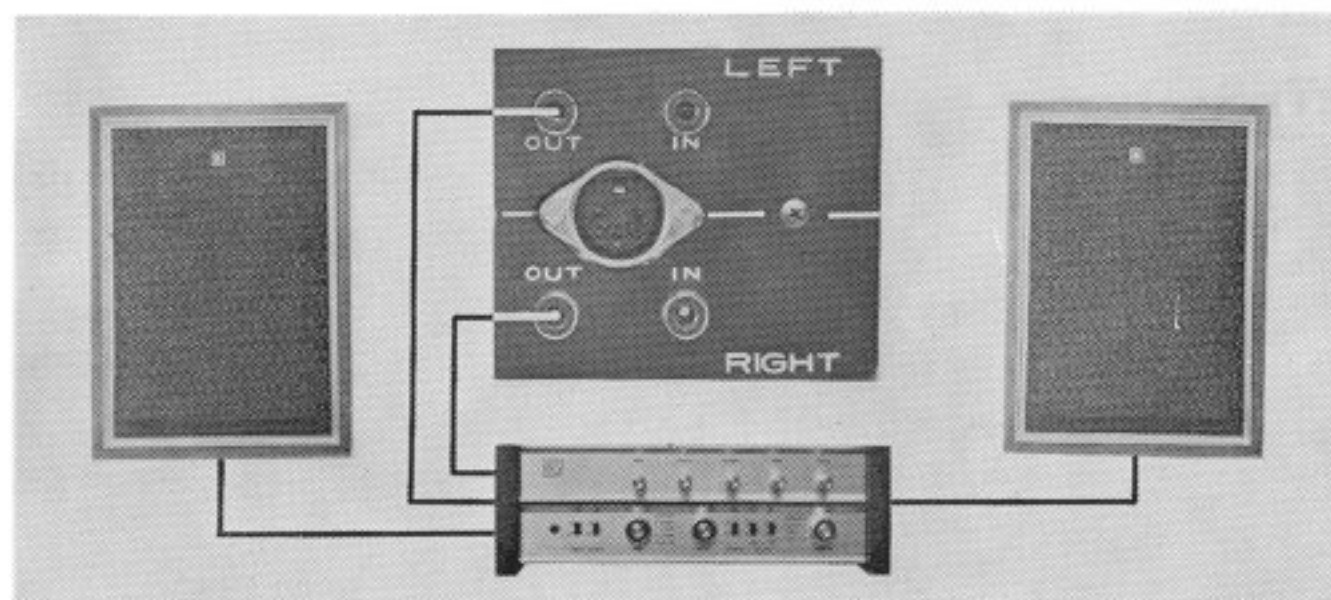

Fig. 18

4. PLAYBACK

STEREO

Connect the recorder to AC power source with the attached AC CORD ③⑤ and load the tape.

- (A) Set POWER/AUTOMATIC SHUT-OFF SWITCH ①⑨ to "ON".
- (B) Set TRACK SELECTOR ⑥ to "STEREO".
- (C) Select the desired tape speed.
- (D) Set EQUALIZER SWITCH ⑧ to 7-1/2 or 3-3/4 ips, whichever is consistent with tape speed.
- (E) Set TAPE/SOURCE MONITOR SWITCH ⑪ to "TAPE".

The Model 4000D does not include a power amplifier or loudspeakers. It, therefore, is necessary to provide an external stereo amplifier and speakers for stereophonic playback.

- (F) Connect both LINE OUTPUT JACKS (③⑩ and ③③) to TAPE INPUT JACKS or AUX INPUT JACKS of the external amplifier. Connect two loudspeakers to the power amplifier.

IMPORTANT :

The output level at the 4000D's output jack is 1.23V maximum. Check your amplifier before operation with input terminals.

- (G) Set RECORD/PLAYBACK LEVER ②③ to "PLAY".
- (H) Adjust the volume of sound by using the volume control knob of the external amplifier.

MONAURAL

For monaural playback, substitute the following steps (B) and (F) of the stereo procedure, and add step (I). Follow the rest of the stereo procedure.

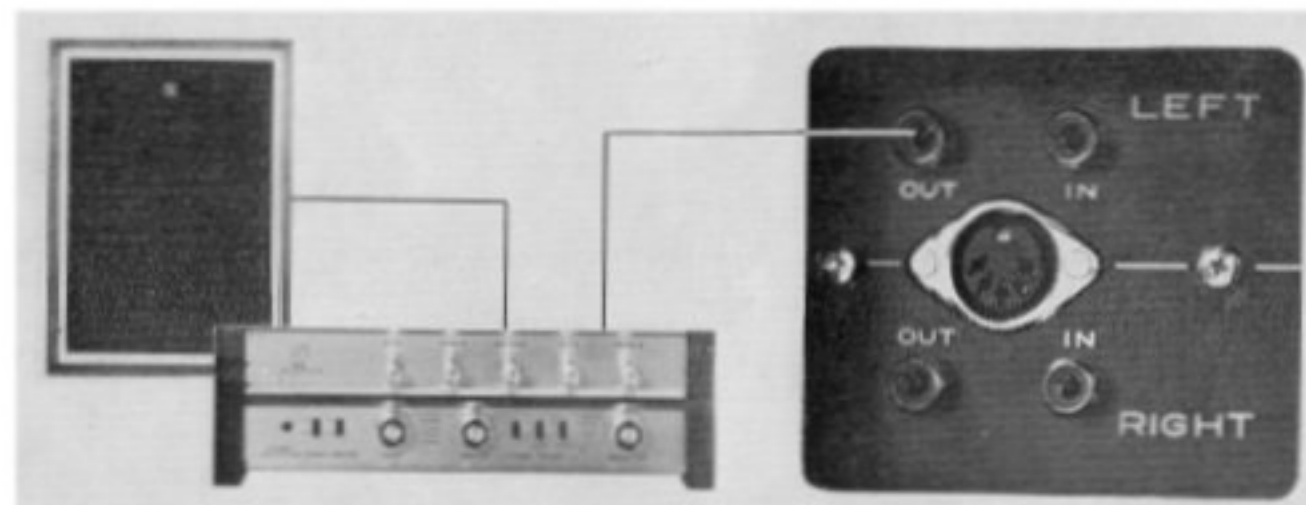

Fig. 19

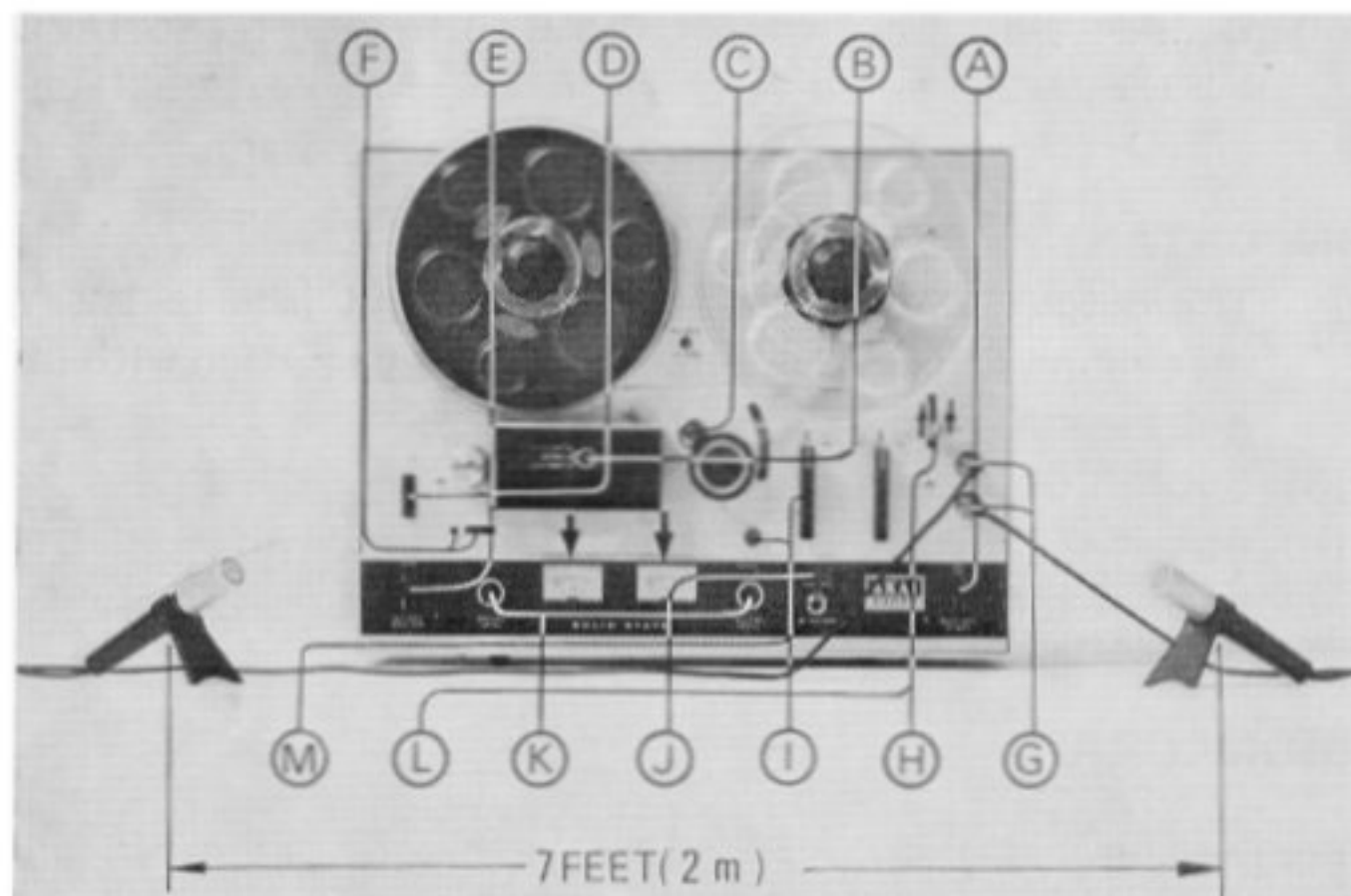

Fig. 20

Playback on tracks 1 and 4

Only the left channel amplifier is used for monaural playback on tracks 1 and 4. So, set RECORD LEVEL CONTROL (RIGHT) 15 to "MONO".

(B) Set TRACK SELECTOR 6 to "1-4".

(F) Connect LINE OUTPUT JACK (LEFT) 30 to TAPE INPUT JACK (LEFT) or AUX INPUT JACK (LEFT) of the external amplifier.

(I) Invert the reels to playback on track 4.

Playback on tracks 3 and 2

Only the left channel amplifier is used for monaural playback on tracks 3 and 2. So, set RECORD LEVEL CONTROL (RIGHT) 15 to "MONO".

(B) Set TRACK SELECTOR 6 to "3-2 RIGHT".

(F) Connect LINE OUTPUT JACK (LEFT) 30 to TAPE INPUT JACK (LEFT) or AUX INPUT JACK (LEFT) of the external amplifier.

(I) Invert the reels to playback on track 2.

5. RECORDING

STEREO

(A) Set POWER/AUTOMATIC SHUT-OFF SWITCH 19 to "ON".

(B) Set TRACK SELECTOR 6 to "STEREO".

(C) Select the desired tape speed.

(D) Set EQUALIZER SWITCH 8 to 7-1/2 or 3-3/4 ips, whichever is consistent with tape speed.

(E) Set TAPE/SOURCE MONITOR SWITCH 11 to either "TAPE" or "SOURCE".

When set to "SOURCE", the program being recorded may be monitored.

When set to "TAPE", the recorded signal is reproduced immediately after the recording.

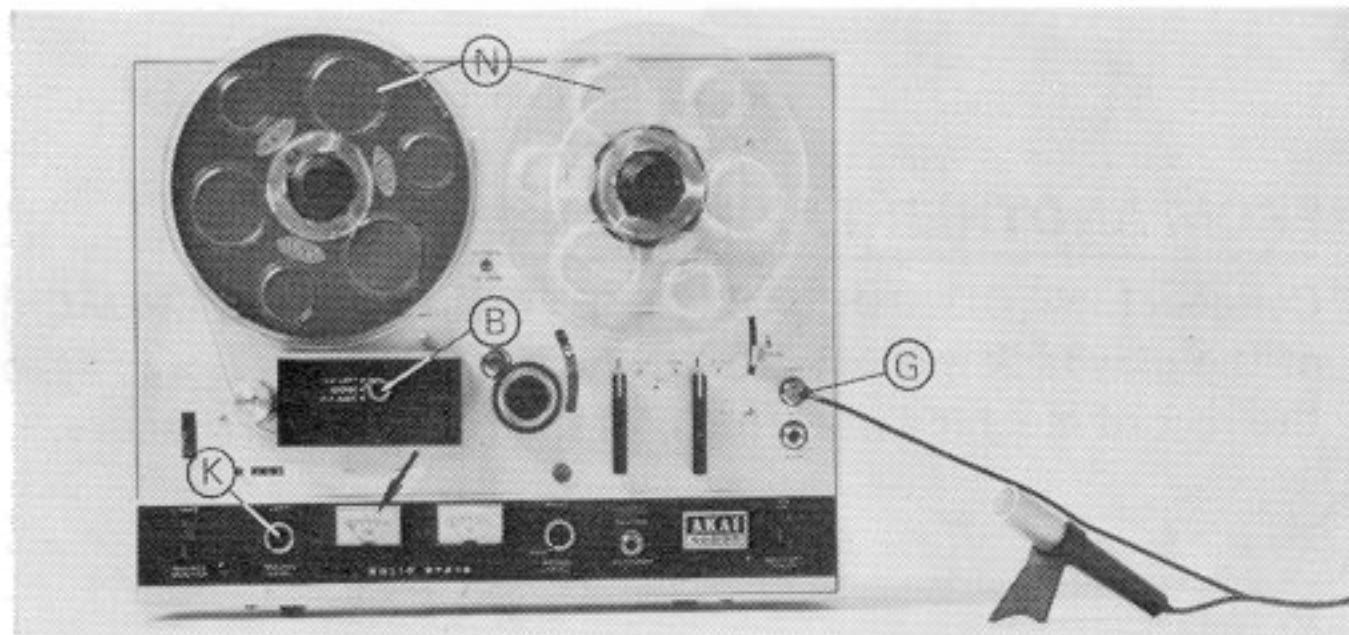

Fig. 21

- (F) Push RESET BUTTON ⑨ and set INDEX COUNTER ⑩ to "000".
This INDEX COUNTER ⑩ provides a reference for locating any position on the tape.
- (G) Insert microphone plugs into MICROPHONE JACKS (⑳ and ㉑).
Maintain a distance of at least seven feet between the microphones.
- (H) Push INSTANT STOP/PAUSE LEVER ㉔ upward until it locks.
- (I) Turn RECORD/PLAYBACK LEVER ㉓ to "REC" position while depressing RECORD SAFETY BUTTON ⑯.
- (J) Check that RECORD INDICATOR LAMP ⑱ is on.
If the lamp is not on, the 4000D will not record.
- (K) Microphone volume level may be adjusted and balanced by RECORD LEVEL CONTROLS (⑫ and ⑮). Normal recording should not exceed the black zone (-20-0) on VU METERS (⑬ and ⑭).
- (L) After optimum recording level is determined, release INSTANT STOP/PAUSE LEVER ㉔ to start stereo recording.
- (M) To stop recording, return RECORD/PLAYBACK LEVER ㉓ while depressing RECORD SAFETY BUTTON ⑯.

MONAURAL

For monaural recording, substitute the following steps (B), (G) and (K) of the stereo procedure, and add step (N). Follow the rest of the stereo procedure.

Recording on tracks 1 and 4

Only the left channel amplifier is used for monaural recording on tracks 1 and 4. So, set RECORD LEVEL CONTROL (RIGHT) ⑮ to "MONO".

- (B) Set TRACK SELECTOR ⑥ to "1-4".
- (G) Insert microphone plug into MICROPHONE JACK (LEFT) ㉑.

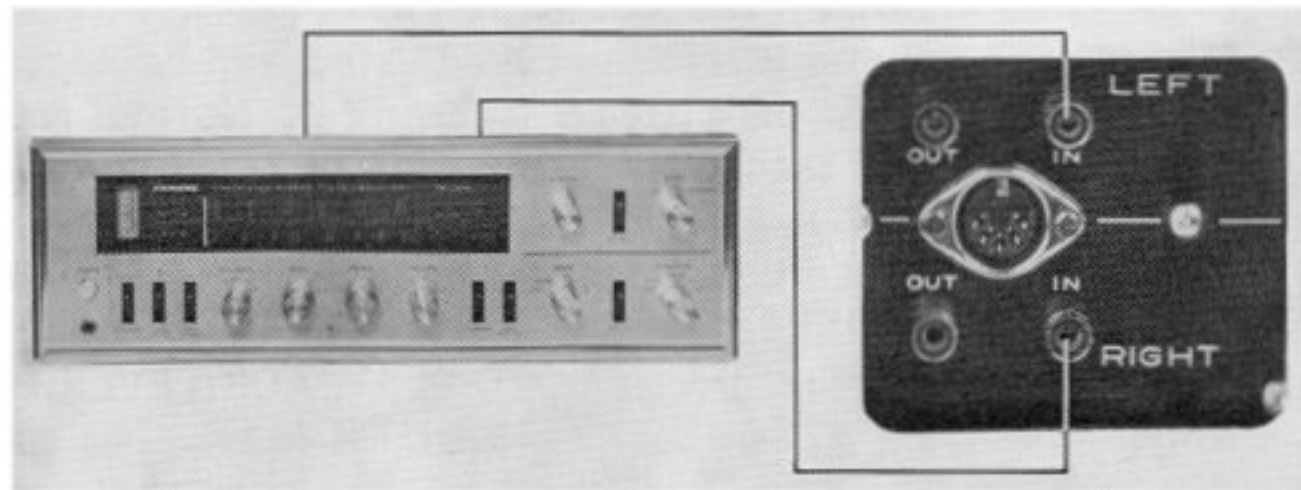

Fig. 22

(K) Microphone volume level may be adjusted and balanced by RECORD LEVEL CONTROL (LEFT) (12), while observing VU METER (LEFT) (13).

(N) Invert the reels to record on track 4.

Recording on tracks 3 and 2

Only the left channel amplifier is used for monaural recording on tracks 3 and 2. So, set RECORD LEVEL CONTROL (RIGHT) (15) to "Mono".

(B) Set TRACK SELECTOR (6) to "3-2".

(G) Insert microphone plug into the MICROWHOLE JACK (21).

(K) Microphone volume level may be adjusted and balanced by RECORD LEVEL CONTROL (LEFT) (12), while observing VU METER (LEFT) (13).

(N) Invert the reels to record on track 4.

FROM AN EXTERNAL AMPLIFIER

If an external amplifier or tuner-amplifier combination is used, connect TAPE OUTPUT leads of the external amplifier to LINE INPUT JACKS (31) and (34) in step (G) of the recording procedure.

FROM ANOTHER TAPE RECORDER

Connect LINE OUTPUT JACKS or EXTERNAL SPEAKER JACKS of the playback machine to LINE INPUT JACKS (31) and (34) of the record machine in step (G) of the recording procedure.

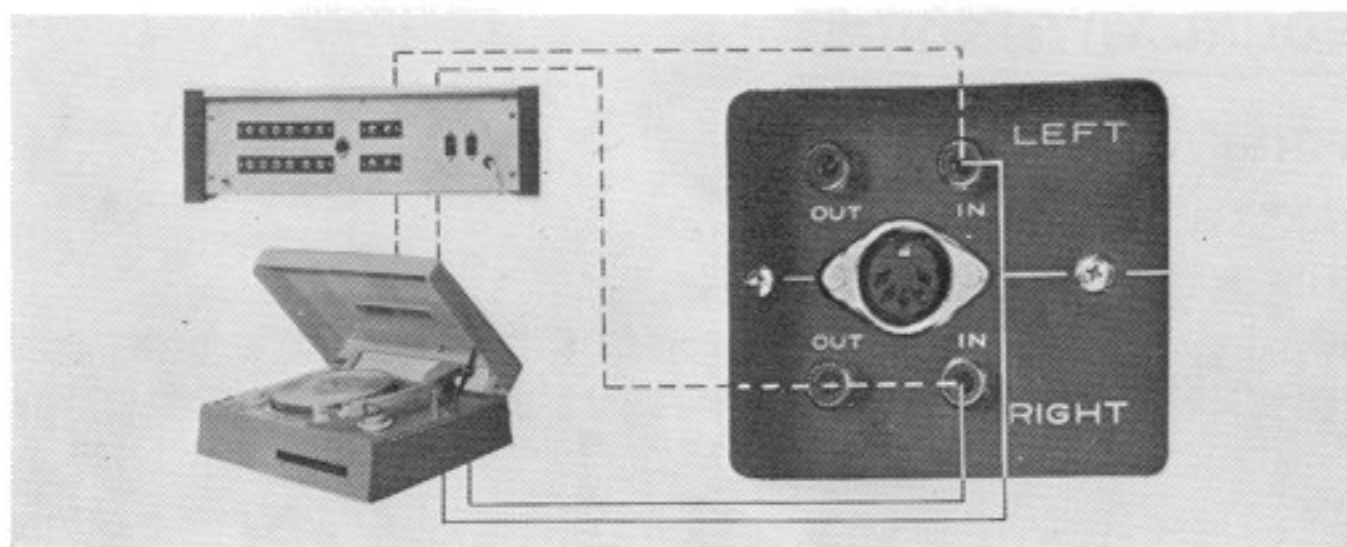

Fig. 23

FROM DISCS

To record from a stereo or monaural disc, a "CRYSTAL PICK UP" or a "CERAMIC PICK UP" can be directly connected to LINE INPUT JACKS (31 and 34) in step (G) of the recording procedure. If a "MAGNETIC CARTRIDGE" is used it must be connected to a separate pre-amplifier or external amplifier before being connected to LINE INPUT JACKS (31 and 34).

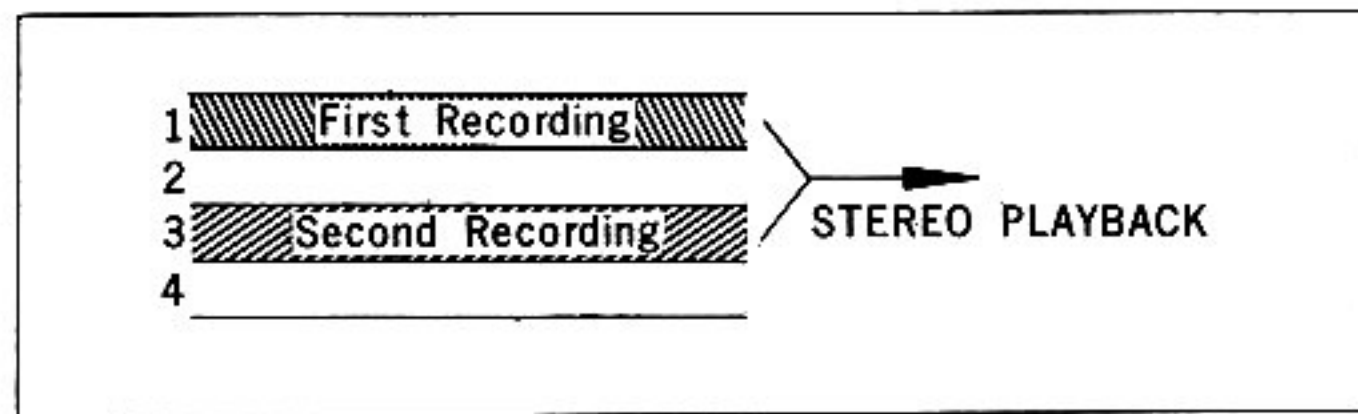

Fig. 24

SOUND WITH SOUND

FIRST RECORDING

- (A) Set POWER SWITCH ⑱ to "ON".
- (B) Set TRACK SELECTOR ⑥ to "1-4".
- (C) Insert microphone plug into MICROPHONE JACK (LEFT) ⑳.
- (D) Set TAPE/SOURCE MONITOR SWITCH ㉑ to "TAPE" or "SOURCE".
- (E) Turn RECORD/PLAYBACK LEVER ㉒ to "REC" position while depressing RECORD SAFETY BUTTON ⑯ for making the first recording on track 1.
- (F) Microphone volume level may be adjusted by RECORD LEVEL CONTROL ⑫.
- (G) When the first recording is complete, rewind the tape to start position.

SECOND RECORDING

- (H) Set TAPE/SOURCE MONITOR SWITCH ㉑ to "TAPE".
- (I) Set TRACK SELECTOR ⑥ to "3-2" for recording on track 3.
- (J) Turn RECORD LEVEL CONTROL (RIGHT) ⑬.
- (K) Connect stereo headphones to STEREO HEADPHONE JACK ⑰ for monitoring the first recording on track 1.
- (L) Turn RECORD/PLAYBACK LEVER ㉒ to "REC" position while depressing RECORD SAFETY BUTTON ⑯. The first recording will be heard through the headphone. Therefore make second recording on track 3 while listening to the first recording on track 1.
- (M) Microphone volume level may be adjusted by RECORD LEVEL CONTROL (LEFT) ⑫, while observing VU METER (LEFT) ⑬.
- (N) When the second recording on track 3 is complete, rewind the tape to start position.
- (O) For playback, set TRACK SELECTOR ⑥ to "STEREO"



Fig. 25

6. MONITORING

Monitoring is performed by connecting stereo headphones to the STEREO HEADPHONE JACK (17).

On monaural as well as stereo recording, please use stereo headphones.

CAUTION: The stereo headphones should be of low impedance type (8 ohms).

7. TAPE SPLICING AND EDITING

Superimpose the tapes and cut them diagonally as illustrated in Figures. Cutting on the diagonal eliminates the "click" or "pop" sound in recording/playback.

Match the aligned ends and apply splicing tape to the glossy side.

Firmly press the splice with fingers to secure the ends evenly. Trim off excess splicing tape (cut into the recording tape very slightly as illustrated by the dotted lines—this eliminates the possibility of a sticky splice.) Because tape splicing with scissors is difficult and requires much skill, it is recommended that our specially designed portable splicer be used to ensure professional results.

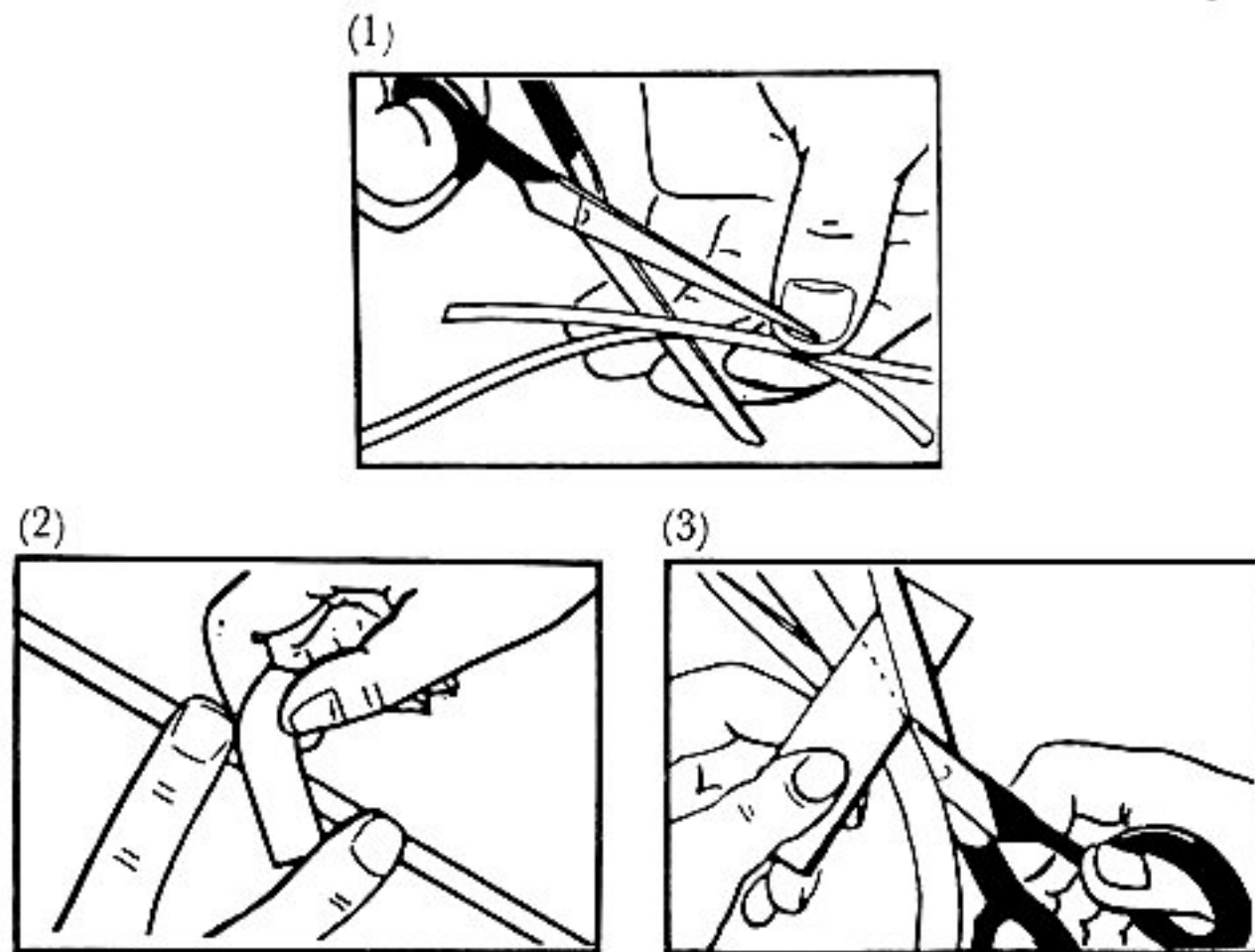

Fig. 26

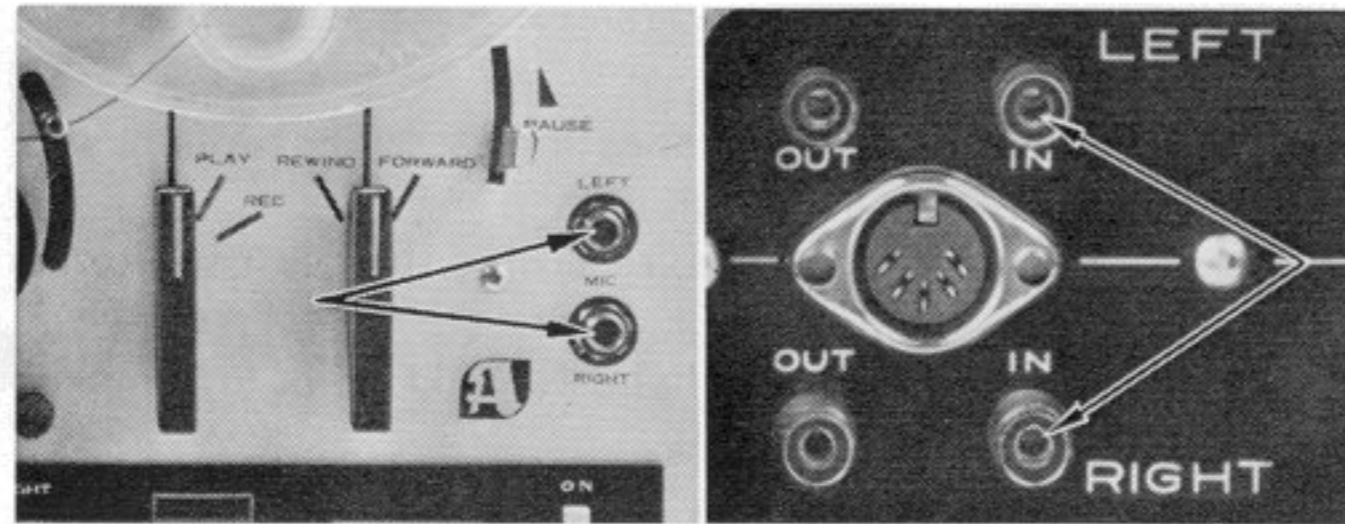

Fig. 27

8. TAPE ERASING

Any signal information previously recorded on the tape will be automatically erased before and as the new recording occurs. Load the tape and set the recorder to the normal record position. No plugs should be connected to the LINE INPUT JACKS (31, 34) and the MICROPHONE JACKS (20, 21). A Bulk Tape Eraser should be used for quick and complete erasing.

9. HEAD CLEANING

Tape Oxide/Dust Deposits Cause 90% of Your Tape Recording Failure

For quality performance it is imperative that tape recorder heads be kept neat and clean at all times.

Dust and magnetic particles from the tape tend to deposit on the heads after prolonged use of the recorder. This results in poor head-to-tape contact deteriorating sound quality and sensitivity. Worse still such dust causes drastic drops in recording/playback levels and nullifies high quality sound.

EXAMPLE

CLEAN HEAD

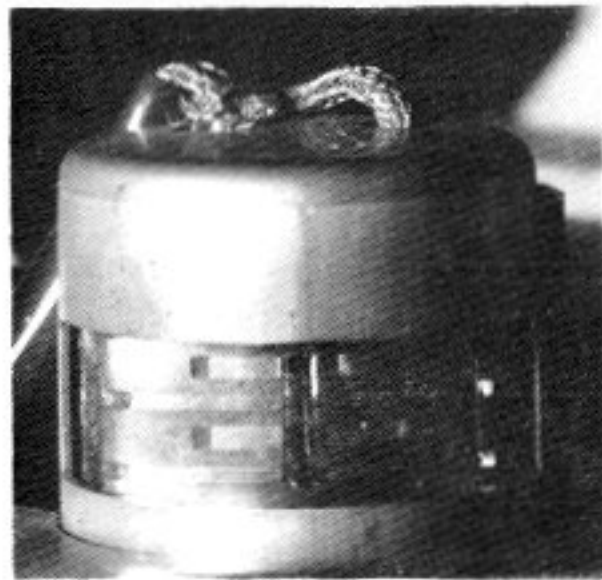

Frequency response curve

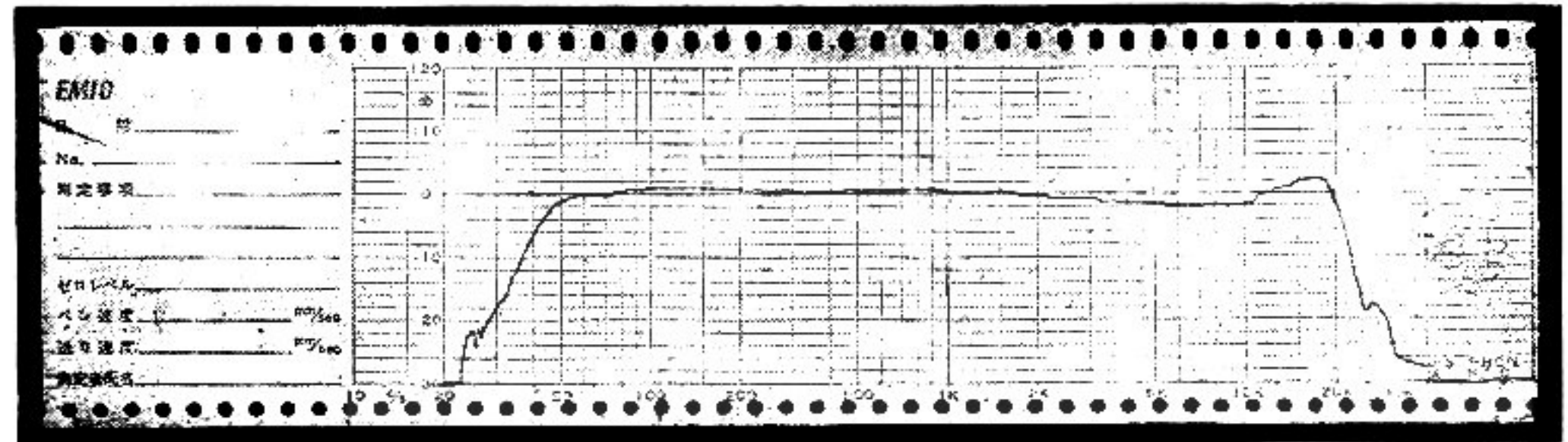

Fig. 28

DUSTY HEAD

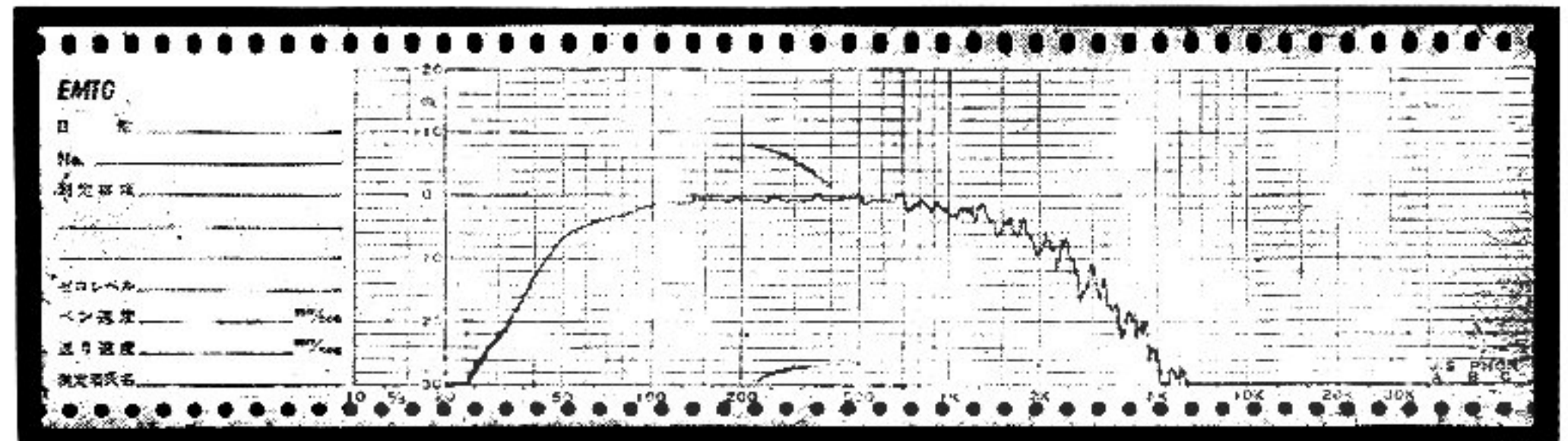

Fig. 29

Make it a rule to clean the heads every time you use your tape recorder. AKAI's Head Cleaning Kit (Accessory NO. HC-500) is recommended for removing foreign matter deposited on the heads. If this kit is not available, use alcohol.



Fig. 30

NOTE: Clean the heads after setting the RECORD/PLAYBACK LEVER ②③ to "PLAY".

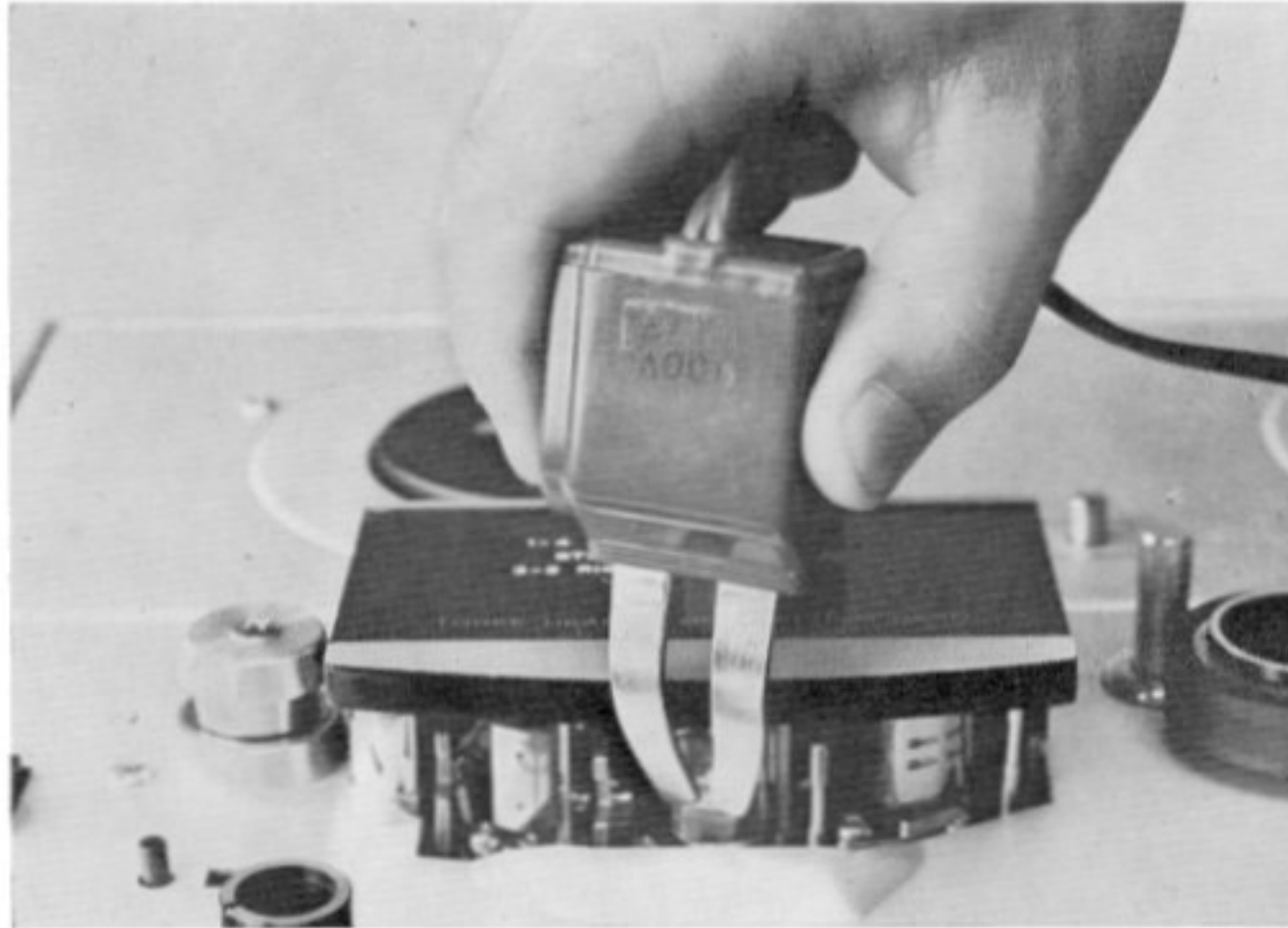

Fig. 31

10. HEAD DEMAGNETIZING

Normally the steel pole pieces which form a part of the recording and playback heads become slightly magnetized. The effect of the slight head magnetization is to partially erase the tape. Mostly high frequencies suffer. Generally, slightly magnetized heads can be detected by noticing loss of normal high frequency response which cannot be corrected through head alignment. Severe magnetization which may result if magnetized tools are used in the vicinity of the heads will result in noise or considerable distortion in addition to the loss of high frequency response. Although the 4000D already has a built-in Head Demagnetizing circuit, it is recommended that head demagnetization be performed periodically.

Head demagnetization can be accomplished by touching the head lightly with the demagnetizer and making several small circular motions over all head surface areas as well as the head housing.

1. OPTIONAL ACCESSORIES

Endless Tape No. AE-1

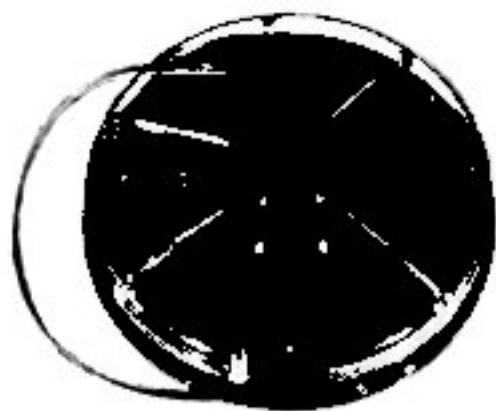

AE-1

Telephone Pick up No. AP-2



AP-2

Tape Splicer No. AS-3



AS-3

Head Demagnetizer No. AH-6



AH-6

Tape Eraser No. ATE-7



ATE-7

Stereo Headphone No. ASE-9S



ASE-9S

Head Cleaning Kit No. HC-500



HC-500

Dynamic Microphone No. DM-13



DM-13

4000D

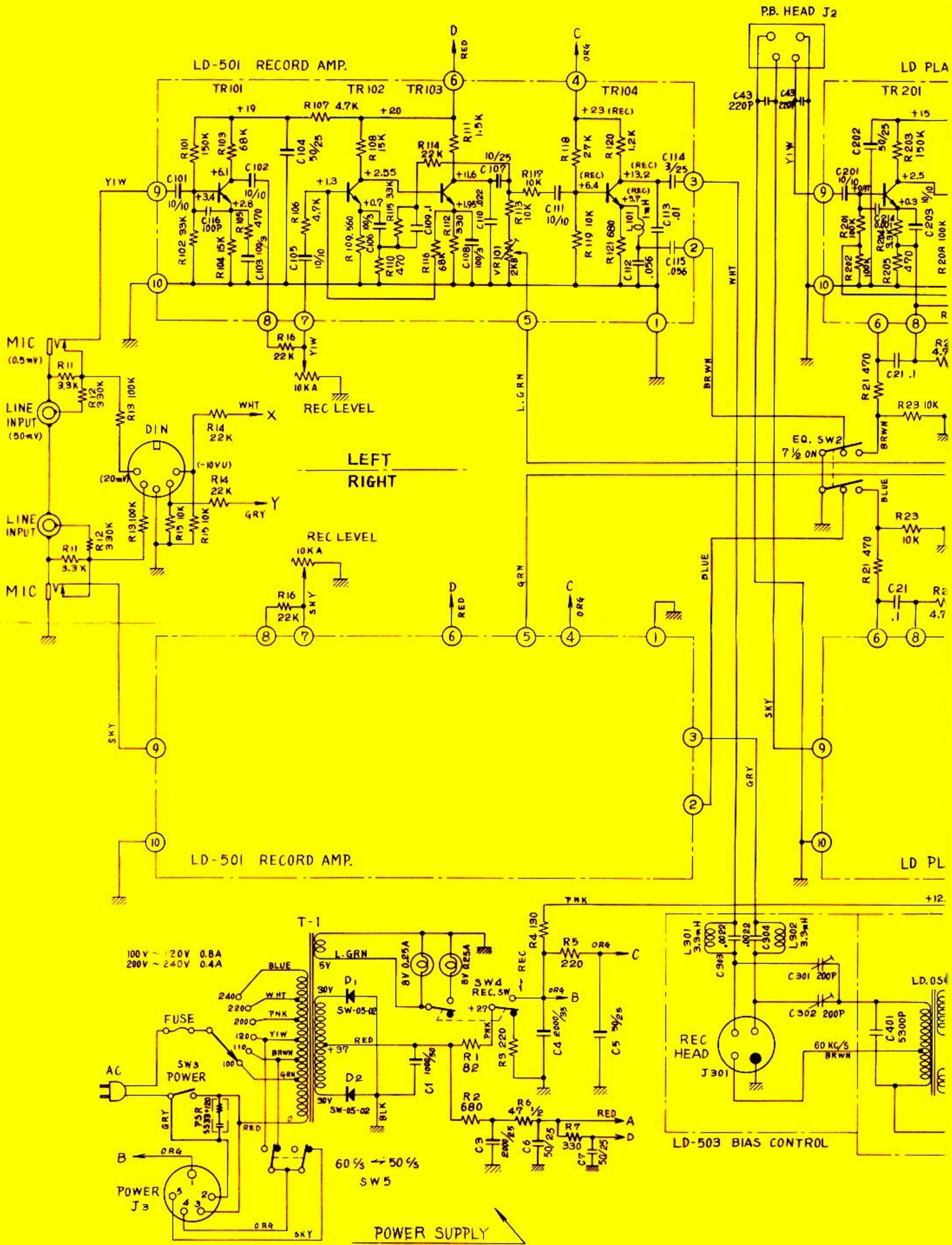

LD PLAY BACK AMP. CARD

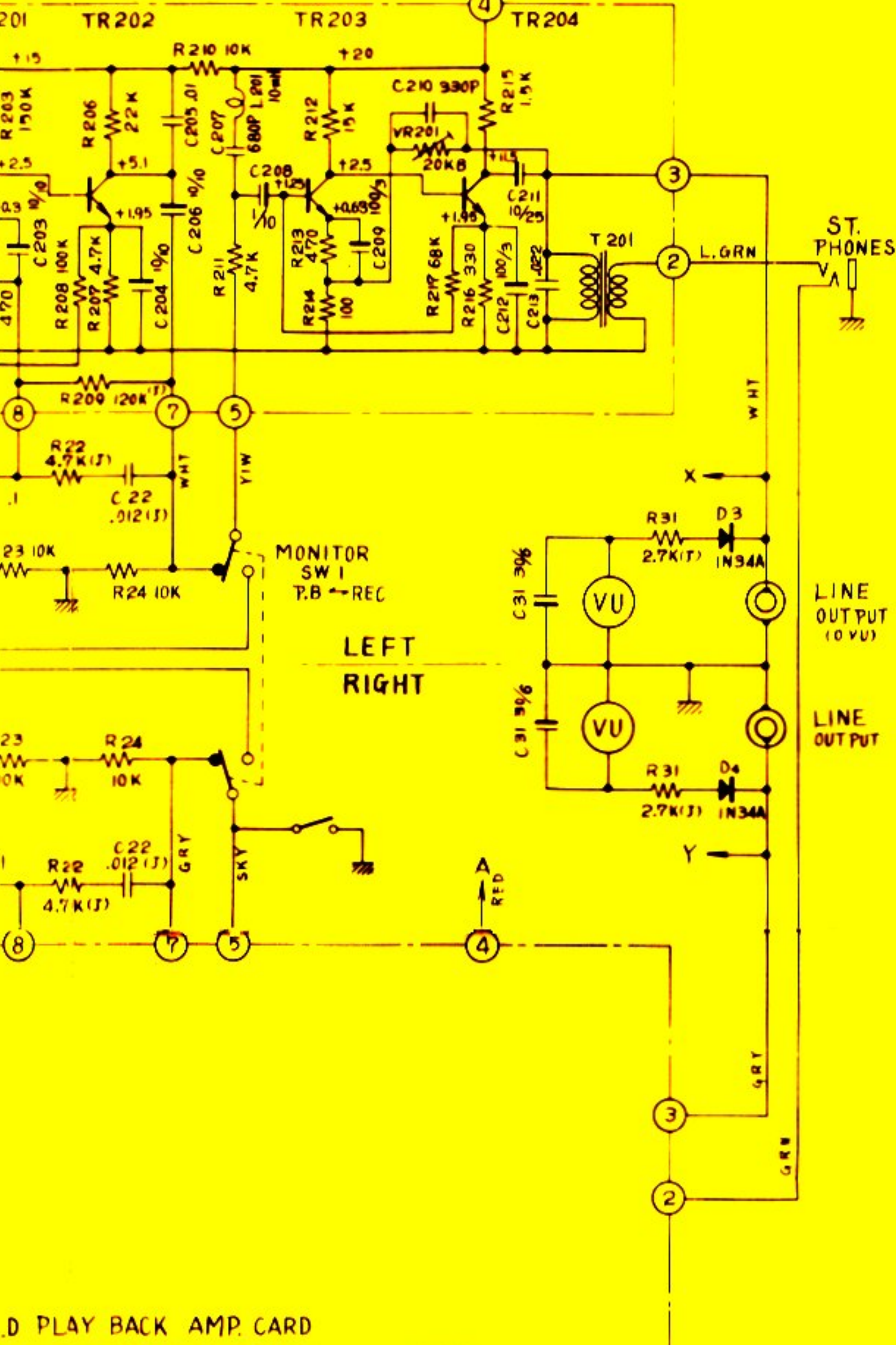

TRANSISTOR

TR 101	2SC650 (B,C)	2
102, 103	2SC281 (B)	4
104	2SC458 (B)	2
TR 201, 202	2SC650 (A,B)	4
203, 204	2SC281 (B)	4
TR 401	2SC696 (J)	1

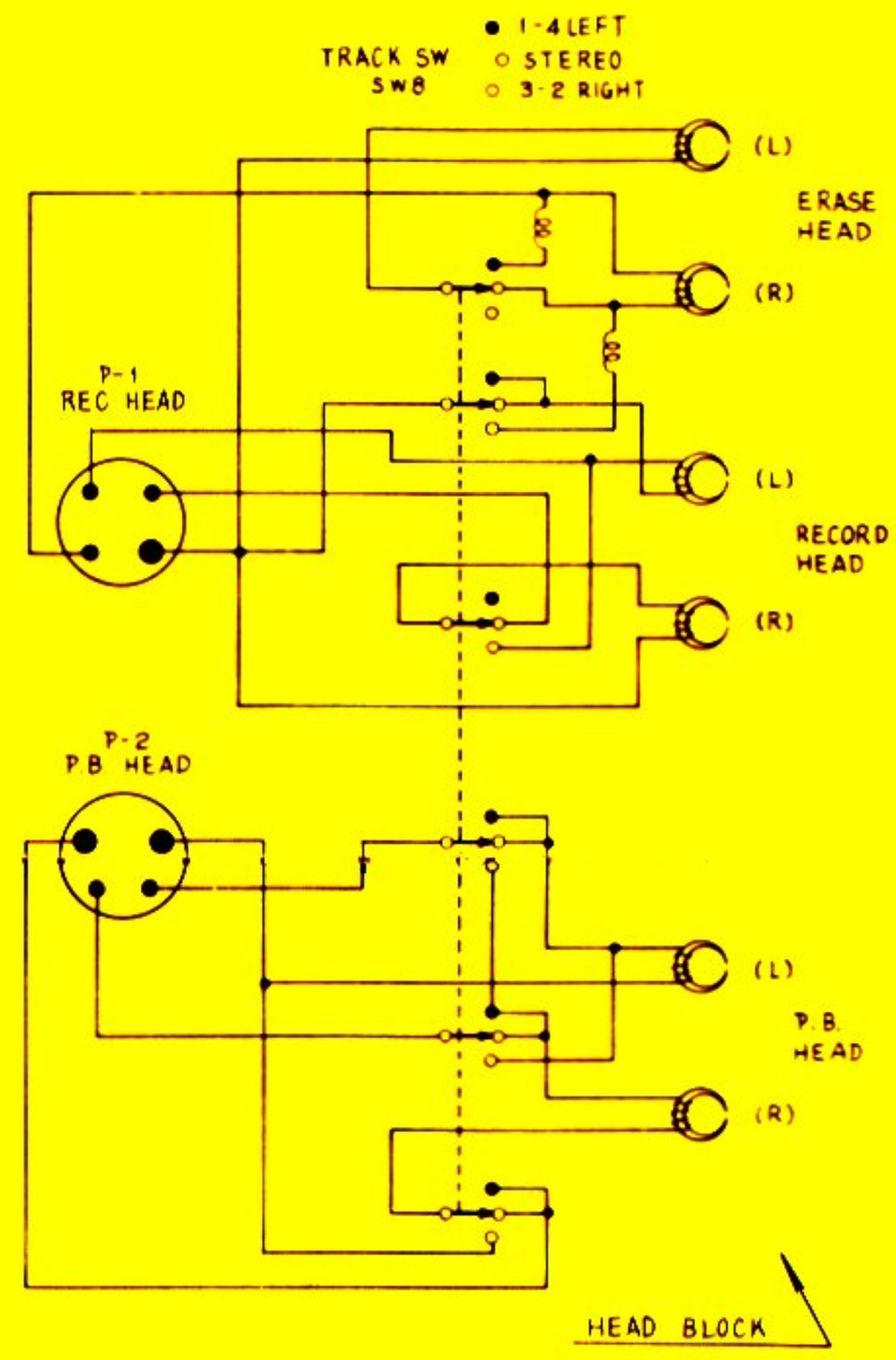

D. PLAY BACK AMP. CARD

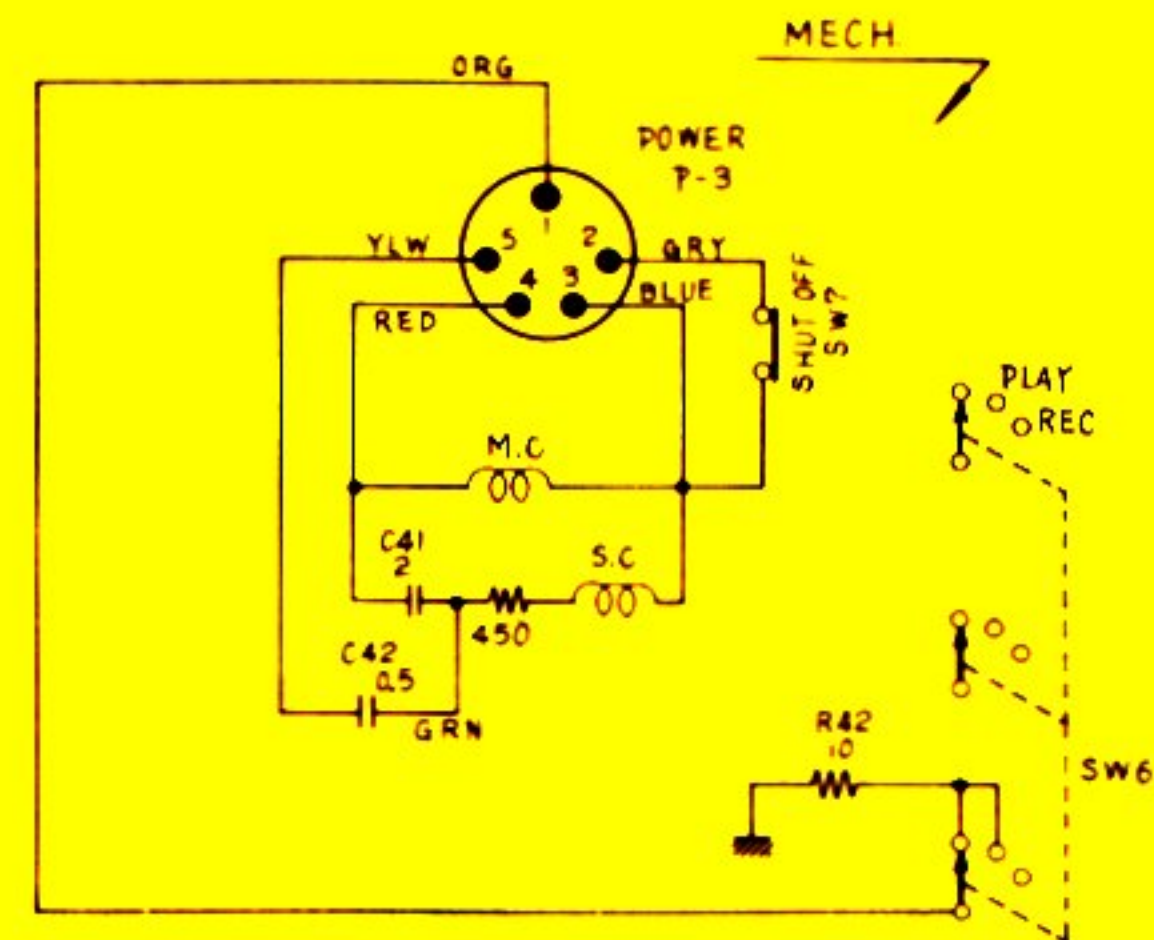
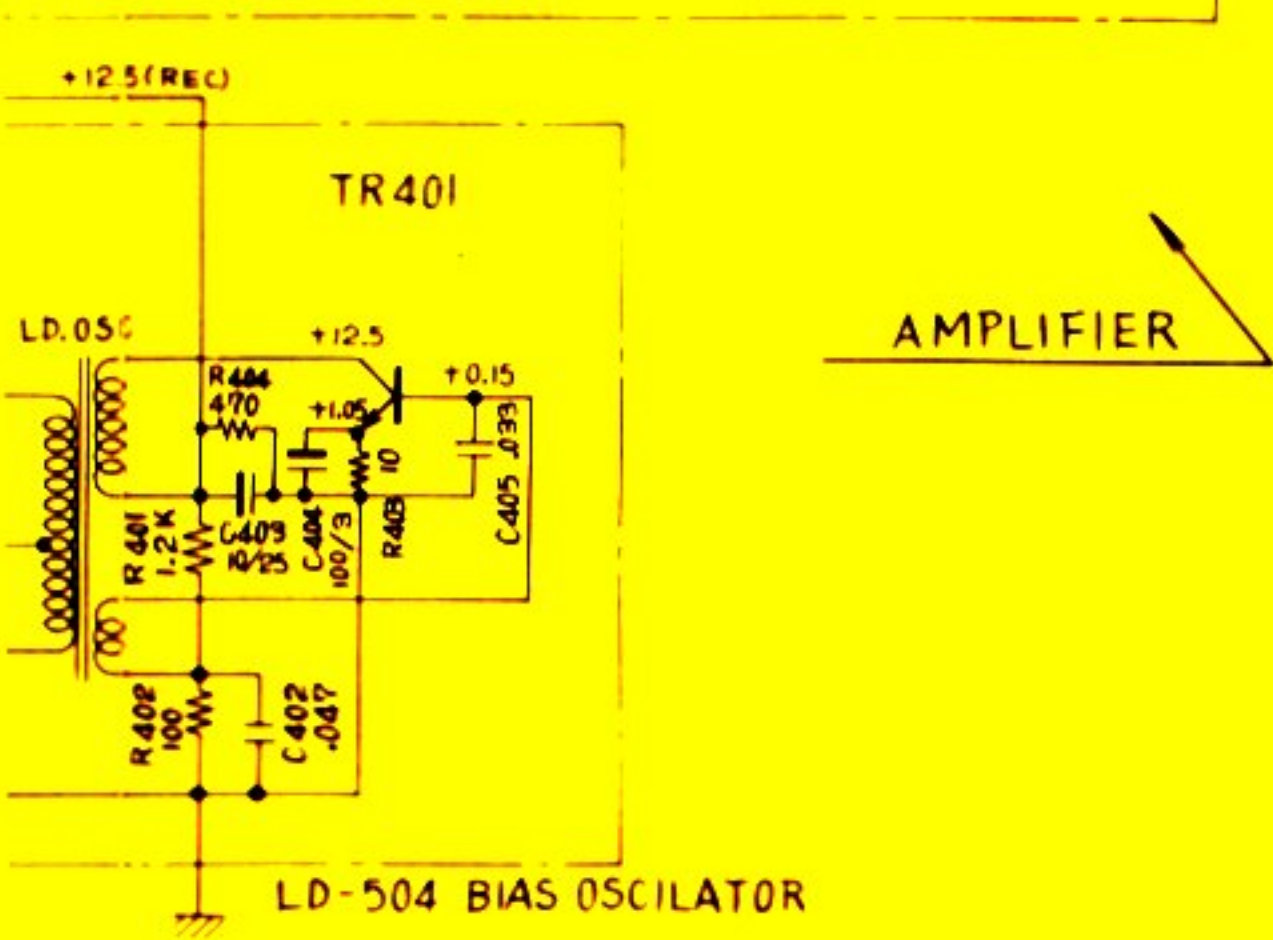



MANUFACTURED & DISTRIBUTED BY
AKAI ELECTRIC CO., LTD.
AKAI TRADING CO., LTD.
12, 2-chome, Higashi-Kojiya,
Ohta-ku, Tokyo, Japan
