

AKAI

1800SS

---

MODEL

---

SERVICE MANUAL

---

## 6. CROSS TALK (Cross talk between the channels)

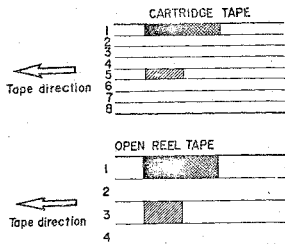

As shown in the figure above, first record a 1,000 Hz sine wave on track No. 1 at +3 VU Level. Next, Remove the 1,000 Hz input signal and record under a non-input condition. Then, playback the tape on track No. 1 and No. 3 (track No. 1 and track No. 5) through the 1,000 Hz B.P.F. (Band Pass Filter, Sensitivity.....1:1) and obtain a ratio between the two from the following formula.

$$C = 20 \log \frac{E_0}{E_2 - E_1} \text{ (dB)}$$

where, C = Desired cross talk ratio  
 $E_0$  = 1,000 Hz signal output level  
 $E_2$  = 1,000 Hz cross talk level  
 $E_1$  = Non-input signal record level



## 7. ERASE RATIO

- 1) Connect a High Sensitivity V.T.V.M. to the Line Output.
- 2) Playback a virgin tape (AKAI "F" Tape) and take a V.T.V.M. reading.
- 3) Next, record a 1,000 Hz. sine wave signal on this tape at a +3 dB level. Playback this recording and take another reading of the output level.
- 4) Next, re-record this pre-recorded tape under its non-input signal condition and take a reading of the erased signal noise output.
- 5) Then use the following formula:

$$Er = 20 \log \frac{E_0}{E_2 - E_1} \text{ (dB)}$$

where,  $E_r$  = Desired erase ratio (dB)  
 $E_0$  = 1,000 Hz signal output level  
 $E_2$  = Non-input signal recorded level  
 $E_1$  = Virgin tape noise output level

## 8. POWER OUTPUT

Playback a 250 Hz "G" VU pre-recorded tape at 7-1/2 ips and measure the output voltage of the recorder to be tested when terminated with  $8 \Omega$ . Then use the following formula:

$$P = \frac{E^2}{R}$$

where, P = Desired power output (watts)  
 $E$  = Measured voltage (R.M.S.)  
 $R = 8 \Omega$

## II. MEASURING METHOD

### 1. TAPE SPEED DEVIATION

Method involving use of pre-recorded tape.

Playback a pre-recorded tape at 1,000 Hz ( $\pm 0.1\%$ ) on recorder to be tested. Connect the appropriate output to a frequency counter meter in order to measure the tape speed deviation.

### 2. WOW AND FLUTTER

Playback a 3,000 Hz pre-recorded tape of which the wow and flutter level is guaranteed to be smaller than 0.07% for measurement by means of a wow meter. It is also possible for a 3,000 Hz sine wave to be recorded and played for measurement by means of the wow meter. In this case, however, the wow meter indicates a value as much as twice the value given in the specifications.

### 3. FREQUENCY RESPONSE

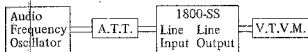

Connect the measuring instruments as in the above diagram, and measure the frequency response in the following sequence.

#### RECORD:

- 1) Supply a 1,000 Hz sine wave signal to the line input of the recorder to be tested through an attenuator from an audio frequency oscillator.
- 2) Set the recorder to Recording Mode and adjust the line input volume so that the VU meter needle indicates "0" VU.
- 3) Under the condition described in (2), lower the input level 16 dB (20 dB for cartridge) by means of the attenuator.
- 4) Record the spot frequency in the range of 40 Hz to 22,000 Hz from the audio frequency oscillator.

#### PLAYBACK:

- 1) Set the recorder to Playback Mode.
- 2) Connect a High-sensitivity V.T.V.M. to the line output.
- 3) Playback the tape previously recorded, make a memo of output level, and plot the value on a graph.

Note: New tape of particularly good quality should be used for measurement of the frequency response. AKAI "F" tape (FUJI S-100) (AKAI "U" tape for cartridge) is recommended.

### 4. SIGNAL TO NOISE RATIO

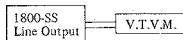

- 1) Playback a 250 Hz "0" VU pre-recorded tape (500 Hz "0" VU pre-recorded tape for cartridge)
- 2) Connect a High-sensitivity V.T.V.M. to the line output of the recorder and measure its output. Then remove the tape and measure the noise level under the same condition. Convert each of the measured values into decibels.

### 5. TOTAL HARMONIC DISTORTION FACTOR

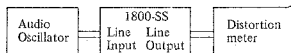

- 1) Connect the measuring instruments as shown above, and record a 1,000 Hz sine wave at "0" VU. Playback the resultant signal and measure the overall distortion factor.
- 2) Measure the noise level of the tape recorder with the tape removed; Connect the audio oscillator directly to the distortion meter for measurement of the distortion factor of the oscillator. The required distortion factor can be obtained from the results of the above measurement by the following formula.

$$d_0 = d - d_1 - d_2$$

- where,  $d_0$  = Required distortion level  
 $d$  = Overall distortion factor  
 $d_1$  = Noise level  
 $d_2$  = Distortion factor of the oscillator

Note: New tape of particularly good quality should be used for measurement of the distortion factor. AKAI "L" (FUJI S-100) tape is recommended.

### III. DISMANTLING OF TAPE TRANSPORT UNIT & AMPLIFIERS

In case of trouble, etc. necessitating disassembly, please disassemble in the order shown in photographs. Reassemble in reverse order.

1

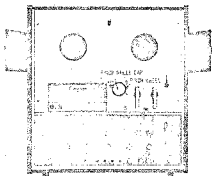

2

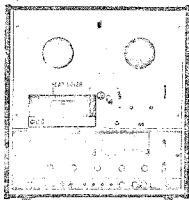

3

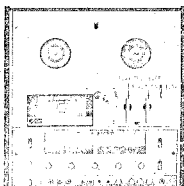

4

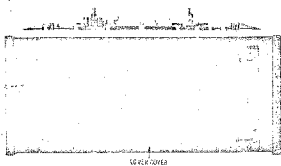

5



6

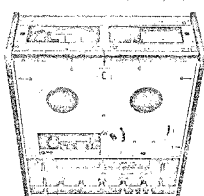

7

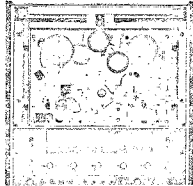

8

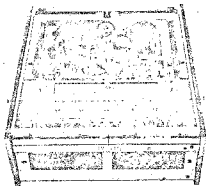

12



9

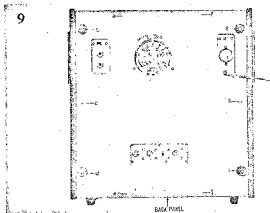

13

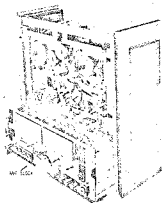

10



14



11

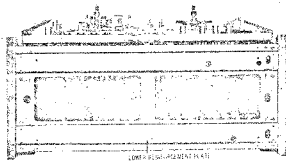

15



**TRACK SYSTEM**

Reel: 4-track 4-channel/2-channel compatible stereo  
 Cartridge: 8-track 4-channel/2-channel compatible stereo

**TAPE SPEED STABILITY**

Reel: 7-1/2, 3-3/4 and 1-7/8 ips  $\pm 1\%$  ( $\pm 3\%$ \*)  
 Cartridge: 3-3/4 ips  $\pm 2\%$  ( $\pm 3\%$ \*)

**WOW AND FLUTTER**

Reel: 7-1/2 ips ..... Less than  $\pm 0.12\%$  ( $\pm 0.2\%$ \*)  
 3-3/4 ips ..... Less than  $\pm 0.15\%$  ( $\pm 0.3\%$ \*)  
 1-7/8 ips ..... Less than  $\pm 0.2\%$  ( $\pm 0.45\%$ \*)  
 Cartridge: Less than  $\pm 0.25\%$  ( $\pm 0.35\%$ \*)

**FREQUENCY RESPONSE**

Reel: At 7-1/2 ips ..... 30 to 22,000 Hz  $\pm 3$  dB  
 (40 to 22,000 Hz  $\pm 3$  dB\*)  
 At 3-3/4 ips ..... 30 to 15,000 Hz  $\pm 3$  dB  
 (40 to 15,000 Hz  $\pm 3$  dB\*)  
 At 1-7/8 ips ..... 50 to 7,000 Hz  $\pm 3$  dB  
 (50 to 6,000 Hz  $\pm 4$  dB\*)  
 Cartridge: 50 to 17,000 Hz  $\pm 3$  dB  
 (50 to 16,000 Hz  $\pm 3$  dB\*)

**SIGNAL TO NOISE RATIO**

Reel: Better than 50 dB (48 dB\*)  
 Cartridge: Better than 45 dB (40 dB\*)

**DISTORTION**

Reel: Less than 1.5% (2%\*) at 1,000 Hz "0" VU recording  
 Cartridge: Less than 3% (4%\*) at 1,000 Hz "0" VU recording

**CROSS TALK**

Reel: Better than 40 dB (stereo)  
 Better than 50 dB (monaural)  
 Cartridge: Better than 45 dB

**ERAISE RATIO**

Reel: Better than 70 dB  
 Cartridge: Better than 65 dB

**OUTPUT****LINE OUTPUT**

1.228V (+4 dB)  $\pm 1.5$  dB using a 250 Hz "0" VU recorded tape (reel); using a 500 Hz "0" VU recorded tape (cartridge).  
 (Required Load Impedance: more than 20 k $\Omega$ )

**DIN OUTPUT**

0.4V

**PHONE OUTPUT**

30 mV at 8  $\Omega$  Load (1800-SS), variable (1800-SS)

**SPEAKER OUTPUT**

5W each channel at 8  $\Omega$  (1800-SS only)

**INPUT****LINE INPUT**

More than 80 mV, Impedance 300 k $\Omega$

**DIN INPUT**

High: More than 80 mV  
 Low: More than 8 mV

**MIC INPUT**

More than 1.5 mV, Impedance 5 k $\Omega$

**MOTOR**

Condenser starting induction 2-speed motor.  
 Revolutions: 3,000 and 1,500 R.P.M. at 50 Hz  
 3,600 and 1,800 R.P.M. at 60 Hz

**RECORDING CAPACITY**

Reel: 60 min./120 min. 4-CH/2-CH stereo recording using a 1,200 ft. tape at 3-3/4 ips.  
 Cartridge: 20 min./40 min. 4-CH/2-CH stereo recording using a 200 ft. tape.

**FAST FORWARD AND REWIND TIME**

100 seconds using a 1,200 ft. tape at 50 Hz.  
 80 seconds using a 1,200 ft. tape at 60 Hz.

**HEADS**

Reel: Rec Recording/Playback Head  
 In-Line 4-track 4-CH/2-CH stereo  
 Impedance: 1,200  $\Omega$   $\pm 15\%$  at 1000 Hz  
 Gap: 2/1,000 mm  
Full Track 4-CH Erase Head  
 In-Line Full track  
 Impedance: 350  $\Omega$   $\pm 10\%$  at 100 kHz  
 Gap: 0.4 mm  
4-Track 2-CH Erase Head  
 In-Line 4-track 2-CH stereo  
 Impedance: 195  $\Omega$   $\pm 10\%$  at 100 kHz  
 Gap: 0.6 mm

Cartridge: Recording/Playback Head  
 In-Line 8-track 4-CH/2-CH stereo  
 Impedance: More than 650  $\Omega$  at 1,000 Hz  
 Gap: 2/1,000 mm  
Erase Head  
 In-Line 8-track 4-CH/2-CH stereo  
 Impedance: 110  $\Omega$   $\pm 10\%$  at 60 kHz  
 Gap: 0.3 mm

**OSCILLATION FREQUENCY**

65 kHz  $\pm 5$  kHz

**TRANSISTORS USED**

8 ..... 2SC458LG (P) (C) 2 ..... 2SC971 (C)  
 8 ..... 2SC711 (P) (D) 1 ..... 2SC1061 (P)  
 1 ..... 2SC968 (D)

**IC USED**

4 ..... LD-3141 2 ..... STK-011 (1800-SS only)

**DIODES USED**

8 ..... 1N34A 2 ..... 10DC-1 (BLK) (1800-SS)  
 9 ..... 10D1 1 ..... 10DC-1 (RED) (1800-SS)  
 1 ..... 10D2 1 ..... 10DC-1 (BLK) (1800D-SS)

**REEL CAPACITY**

Up to 7" reel

**POWER SUPPLY**

100V to 240V AC; 50/60 Hz

**POWER CONSUMPTION**

75W (1800-SS); 45W (1800D-SS)

**INSULATION RESISTANCE**

More than 50 M $\Omega$

**INSULATION DURABILITY**

1,000V AC for more than 1 minute duration.

**DIMENSIONS**

420(W)  $\times$  445(D)  $\times$  240(D) mm (16.8  $\times$  17.8  $\times$  9.6")

**WEIGHT**

1800-SS 23 kg. (51 lbs.)  
 1800D-SS 21 kg. (46 lbs.)

## IV. MECHANISM ADJUSTMENT

### 1. PINCH WHEEL ADJUSTMENT

It is important that the pinch wheel shaft be kept in perfect alignment with the capstan shaft. Proper pinch wheel pressure is between 1,000 and 1,150 grams when the unit is operated at the tape speed of 7-1/2 ips. Any deviation will result in wow and flutter. Check pinch wheel pressure with a spring scale, and if necessary, adjust the pinch wheel load spring.

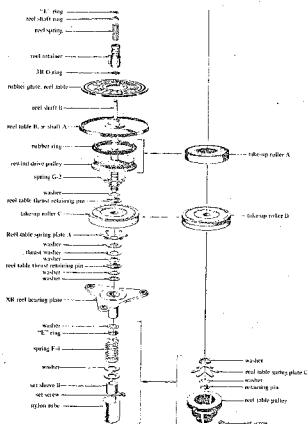

Fig. 1

### 2. TAKE-UP REEL SHAFT ASSEMBLY ADJUSTMENT

A felt clutch is attached to the bottom side of the reel table base plate so that recording tape will not stretch due to excessive tension during fast forward operation. To check the amount of friction on this part, install a 5-inch reel with a 60 mm diameter tape and gently pull the end of the tape upward with a spring scale. Adjust the conical spring so that the amount of tension on this part is between 350 to 450 grams. Another felt clutch is attached to the take-up drive wheel to provide proper slippage during record or play mode. The procedure for checking friction of this part is the same as the foregoing, and between 140g  $\pm$  10g of friction provides the best results. Adjust the star-shaped spring just under the take-up drive wheel. During rewind operation, the amount of friction of this part will decrease to 10 to 15

### 3. SUPPLY REEL SHAFT ASSEMBLY ADJUSTMENT

A felt clutch is used between the lower side of the reel table base plate and the rewind rubber ring to prevent the recording tape from excessive tension during recording. To check the amount of friction on this part, install a 5-inch reel with a 60 mm diameter tape, and gently pull the end of tape upward with a spring scale. Adjust the conical spring so the tension is between 350 and 450 grams. Another felt clutch is attached to the rewind drive wheel to provide proper slipping operation during record or play mode. The procedure for checking friction on this part is the same as the foregoing, and between 100g  $\pm$  10g of friction gives best results. In fast forward operation, the amount of friction will decrease to 10 to 15 grams.

Check to see whether this is correct. If not, readjust coil spring and spring retainer washer. (See figure 1 (a) at left).

### 4. ADJUSTMENT OF FUNCTION LEVER A AS WELL AS FUNCTION LEVER B

With "CART" Function Switch at depressed condition, loosen Screws (a) to (f) and adjust position of Lever A<sub>1</sub> to Lever A<sub>2</sub> of Lever A as well as Lever B<sub>1</sub> and Lever B<sub>2</sub> of Lever B so that the various slide switches come to perfect playback condition.

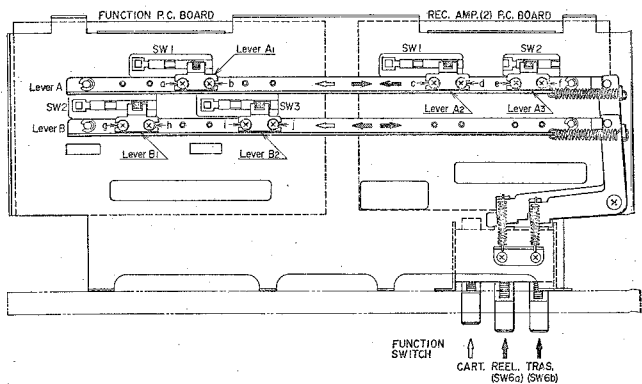

Fig. 2



## V. HEAD ADJUSTMENTS

### A. OPEN REEL HEAD ADJUSTMENTS

#### 1. Head Height Adjustment (See Figs. 3 and 4)

- 1) Erase Head (2-CH)
 

Loosen Erase Head Screws (b) (b') and adjust Erase Head height so that the upper edge of the tape is about 0.15 mm lower than the upper Erase Head core.
- 2) Erase Head (4-CH)
 

Loosen Erase Head Screws (a) (a') and adjust Erase Head height so that the tape is equidistant in relation to the top and bottom edges of the Erase Head core (width between top edge of tape and top edge of head core is the same as the distance between the bottom edge of the tape and the bottom edge of the head core).
- 3) Recording/Playback Head
 

Adjust Recording/Playback Head Height by turning Recording/Playback Head Height Adjustment screws (c) (d), to left and right until the width between the upper edge of Channel 1 Head Core and the upper edge of the tape is equal to the width between the lower edge of Channel 4 Head Core and the lower edge of the tape.

#### 2. Recording/Playback Head Slant Adjustment (See Fig. 3)

By turning Head Height Adjustment Screws (c) (d) to left and right, adjust so that the Recording/Playback Head contacts the tape surface at a right angle (head is at right angle in relation to tape surface).

#### 3. Recording/Playback Head Azimuth Alignment Adjustment (See Fig. 3)

Connect a High Sensitivity V.T.V.M. (Model 161 A) to the Line Output and playback a Head Alignment Test Tape (8,000 Hz, 3-3/4 ips). Adjust by turning Head Alignment Adjustment Screw (e) to left and right until the various line outputs reach maximum.

4. Repeat adjustments outlined in 1-(2) as well as 2. and 3. above two or three times to obtain optimum adjusted condition.

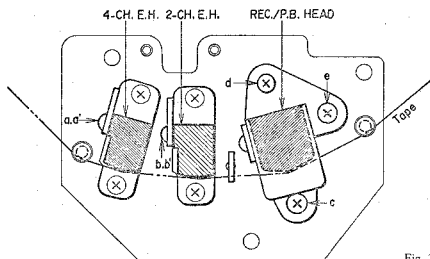

Fig. 3

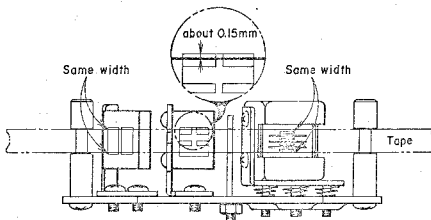

Fig. 4

## B. CARTRIDGE HEAD ADJUSTMENT

### 1. Head Angle Adjustment

Connect a High Sensitivity V.T.V.M. (Model 161 A) to the Line Output. Playback Program 3 of an 8,000 Hz pre-recorded tape and adjust Screw (c) shown in Fig. 5 so that the V.T.V.M. indication is maximum.

### 2. Head Height and Cross Talk Adjustment

- 1) Connect a High Sensitivity V.T.V.M. (Model 161 A) to the Line Output. Set 4-CH/2-CH Selector to "2-CH" position.
- 2) Playback Program 2 of \*Test Tape and adjust Screw (d) shown in Fig. 5 so that the V.T.V.M. indication is minimum.
- 3) In case of 1800-SS, with Volume Control turned to maximum, adjust Screw (d) until the sound emitted from the speaker is minimized.
- 4) The adjustments outlined in items 2) and 3) above will result in ideal head height position and minimize cross talk.

#### \* Test Tape

This test tape is a tape specially designed by AKAI for Head Height and Cross Talk Adjustment tests.

|           |       |           |
|-----------|-------|-----------|
| Program 1 | ..... | 1,000 Hz. |
| Program 2 | ..... | Blank     |
| Program 3 | ..... | 1,000 Hz. |
| Program 4 | ..... | 3,000 Hz. |

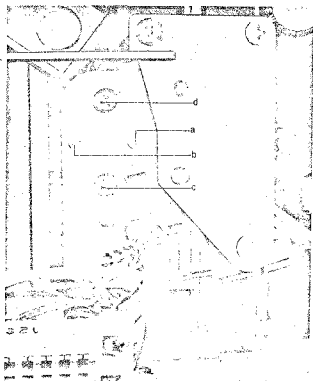

Fig. 5

### 3. Confirmation of Head Height

- 1) Record a 1,000 Hz "O" VU signal on a \*Blank Test Tape. Next, run the tape under a non-input signal condition. Then playback the tape.
- 2) At this time check to see whether or not the recorded sound is emitted from the speaker or line output.
- 3) If no signal or no sound is emitted, the height of the recording and erase heads are properly adjusted. If the recorded signal has not been perfectly erased and is emitted from the speaker or line output, the recording and erase head height is not properly adjusted and the following adjustment is necessary.

"Turn Screws (a) and (b) in the same direction and to the same degree and turn screw (c) in the opposite direction to the same degree (See Fig. 6). This fine adjustment screw should not be turned to exceed  $10^\circ$  and should equal the degree to which screws (a) and (b) have been adjusted.

4. After the above adjustment has been carried out, it is necessary to readjust Head Heights and Cross Talk. Use a \*Test Tape and make the adjustments outlined in items 2-2) and 2-3) again.

#### \* Blank Test Tape

This is also a special tape designed by Akai. Duration of tape is only 15 seconds.

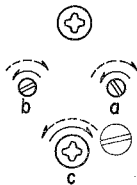

Fig. 6

## VI. AMPLIFIER ADJUSTMENT

### 1. ADJUSTMENT OF RECORDING BIAS FREQUENCY (See Fig. 7)

Connect a Frequency Counter (Model 145 C) to points (A) and (B) and read the Frequency Counter indication. If the Frequency Counter reading is  $65 \pm 5$  kHz, the recording bias frequency is correct. If the recording bias frequency is incorrect, it can be adjusted by changing the value of Condenser C-1. (Oscillator Circuit).

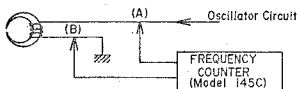

Fig. 7

### 2. ADJUSTMENT OF RECORDING BIAS VOLTAGE (See Fig. 8)

Connect a V.T.V.M. (Model 107 A Type) to points (A) and (D) and measure the bias voltage. Correct recording bias voltage is about 15 to 30 V AC (10 to 30 V AC for Cartridge). Adjustment can be made with TC-1 to TC-4 (VR-9 to VR-12 for cartridge). Correct Erase Voltage is about 40 to 50 V AC.

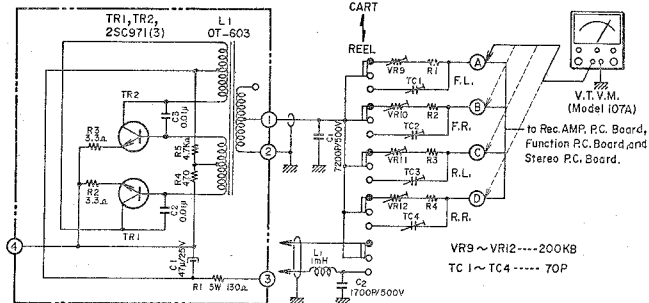

Fig. 8

### 3. ADJUSTMENT OF PLAYBACK LEVEL (See Fig. 9)

- 1) Connect a High Sensitivity V.T.V.M. (Model 161 A) to the Line Output.
- 2) Turn Volume Control (VR-1a to VR-1d 50K $\Omega$ ) up to maximum.
- 3) Playback a 250 Hz "0" VU pre-recorded tape at 7-1/2 ips (500 Hz "0" VU pre-recorded tape at 3-3/4 ips for cartridge), and turn the potentiometer (VR-1 30K $\Omega$ ) until the line output level reaches +4 dB (1.228V). *VR 1 30k $\Omega$*

### 4. ADJUSTMENT OF RECORDING AND PLAYBACK LEVEL (See Fig. 10)

- 1) Load a Blank Test Tape.
- 2) Set recorder to recording mode and turn Volume Control (VR-1a to VR-1d 50K $\Omega$ ) up to maximum.
- 3) Supply a 1,000 Hz sine wave signal from an Audio Frequency Oscillator through the attenuator to the line input and adjust the attenuator so that the V.T.V.M. indicates +4 dB (VU Meter needle indicates "0" VU).
- 4) After a few seconds of recording, playback the recorded tape from the starting point and check the V.T.V.M. indication.
- 5) If the line output does not reach +4 dB, repeat recording and playback procedure from item 3) and adjust potentiometer VR-1 to VR-4 10K $\Omega$  (VR-5 to VR-8 for cartridge) until +4 dB is obtained.

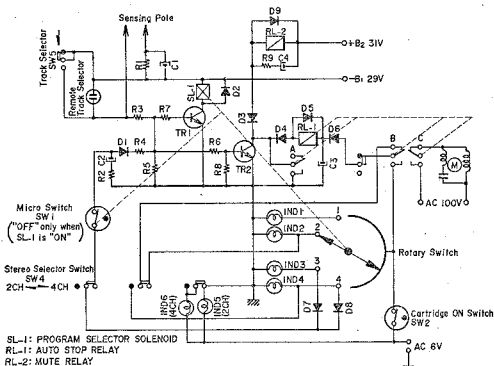

Fig. 15

**PROGRAM SELECTOR CIRCUIT OPERATING PRINCIPLES**

**1. Continuous Playback (4-channel mode)**

In the case of 4-channel cartridge operation, because only Programs 1 and 2 exist, the Program Selector must automatically skip channels 3 and 4.

Explanation of this operating principle using Fig. 15:

a) While the cartridge tape is running during Program 2, when the sensing tape passes the Sensing Pole, current flows to the base of TR-1 through C-1, R-3, and R-7. Consequently, TR-1 collector current flows through Solenoid SL-1.

Because SL-1 is interlocked with the Program Selector Rotary Switch, when SL-1 is energized to "ON" condition, the Rotary Switch moves to Program 3 position. When the sensing tape passes the sensing pole, because C-1 charge current flows, TR-1 is turned "ON", but when C-1 charge current decreases, it is turned "OFF".

Consequently, TR-1 is "ON" only momentarily.

b) When the Rotary Switch moves to Program 3 position, at the same time current flows to the base of TR-1 through D-7, SW-4, SW-1, D-1, R-4 and R-7 and TR-1 is again turned "ON". When TR-1 is turned "ON", Solenoid SL-1 is also turned "ON" and the Rotary Switch moves to Program 4 position.

At this point, SW-1 is "OFF" only at the time when Solenoid SL-1 is energized. When SW-1,

which is the Micro Switch, is "OFF", TR-1 base current ceases to flow and TR-1 is turned "OFF".

Consequently, Solenoid SL-1 is momentarily turned "ON", and immediately returns to "OFF" again.

c) When the Rotary Switch reaches Program 4 position, the base current again flows to TR-1 through Diode D8, SW-4, SW-1, D-1, R-4, and R-7 and TR-1 is turned "ON" and Solenoid SL-1 is also turned "ON".

Because of this, the Rotary Switch returns to Program 1 position.

**2. AUTOMATIC STOP (4-channel mode)**

a) While the cartridge tape is running during Program 2, DC voltage is supplied to TR-2 Collector through Relay RL-1 contact point, SW-3, D-6, and D-4.

b) At this condition, when the sensing tape passes the sensing pole, base current flows to TR-2 through C-1, R-3, and R-6. Consequently, when TR-2 is "ON", Relay RL-1 is also "ON".

c) When Relay RL-1 is turned "ON", Relay contact point (A) as well as (B) operate as lock circuits, and because contact point (C) cuts off the motor's electric source supply circuit, the motor stops, thus effecting Automatic Stop.

d) In the case of 2-channel mode, DC voltage is supplied to Relay RL-1 circuit only at Program 4. Accordingly, RL-1 operates only at the end of Program 4 when the sensing tape passes the sensing pole, thus effecting Automatic Stop at that time.

# VIII. COMPOSITE VIEWS OF COMPONENTS

## LINE AMP. P.C. BOARD (DF-5023)

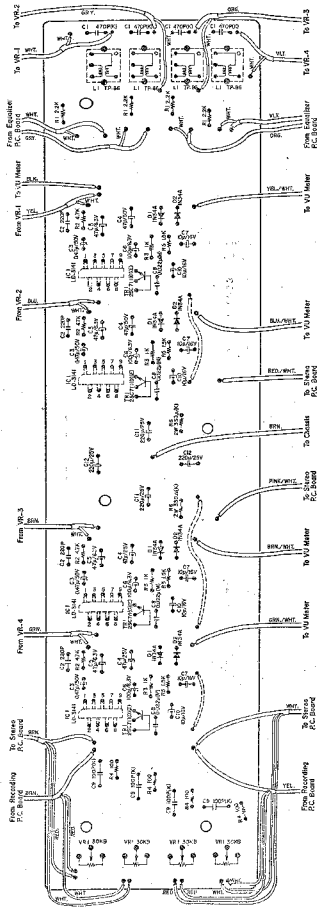

## RECORDING AMP. P.C. BOARD (1)

(DF-5139)

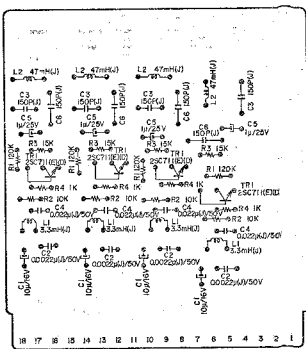

## OSCILLATOR P.C. BOARD (MR-505)

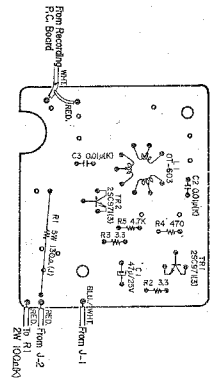

## RECORDING AMP. P.C. BOARD (2) (DF-5040)

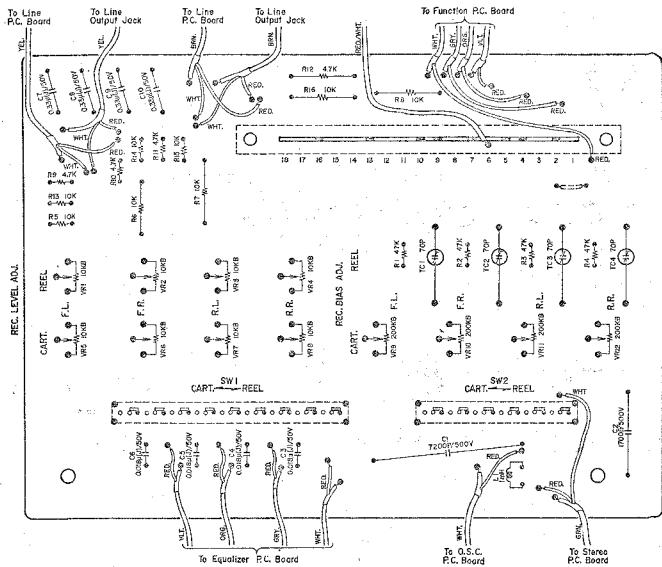

## POWER AMP. P.C. BOARD (ED-515)

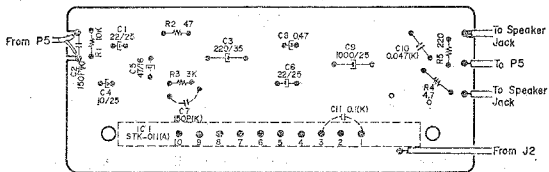

# HEAD AMP. P.C. BOARD (DF-5041)

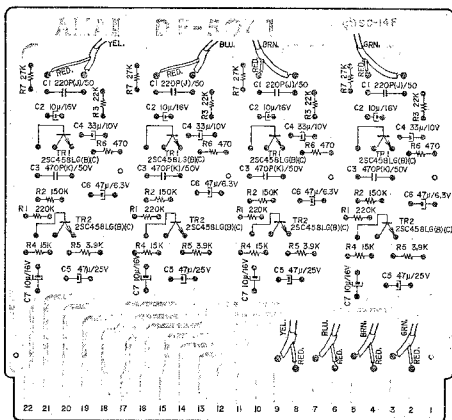

# EQUALIZER P.C. BOARD (DF-5019)

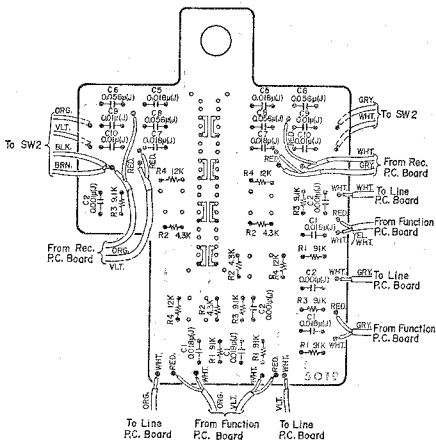

### CARTRIDGE P.C. BOARD (DF-3001)

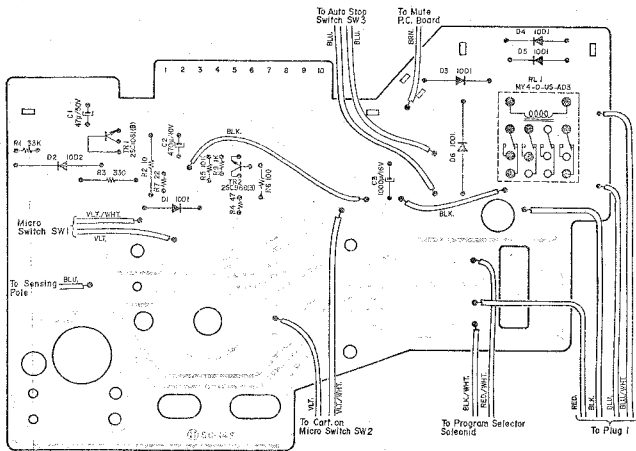

### MIC JACK P.C. BOARD (DF-5090)

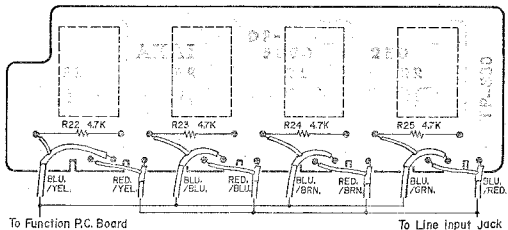



# FUNCTION SWITCH P.C. BOARD (DF-5048A, B)

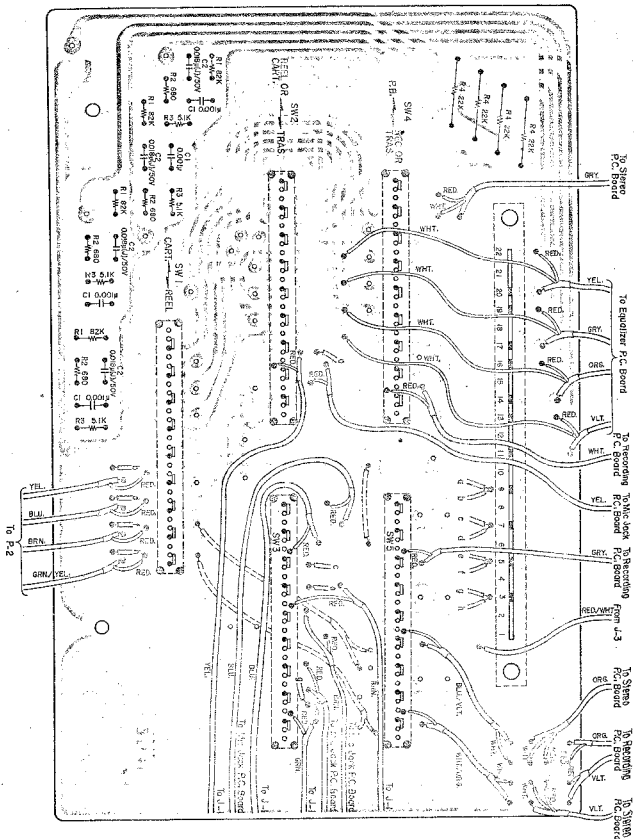

### MUTING P.C. BOARD (DF-5070)

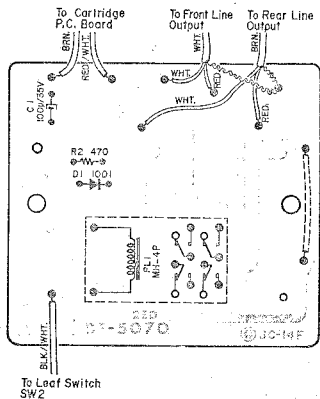

### STEREO SELECTOR P.C. BOARD (DF-5013)

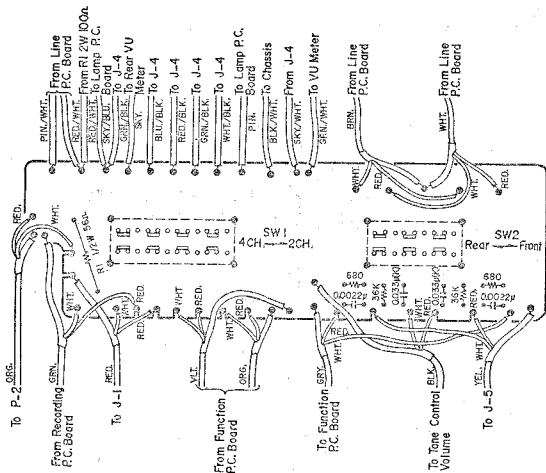

POWER SUPPLY P.C. BOARD (DF-5052)

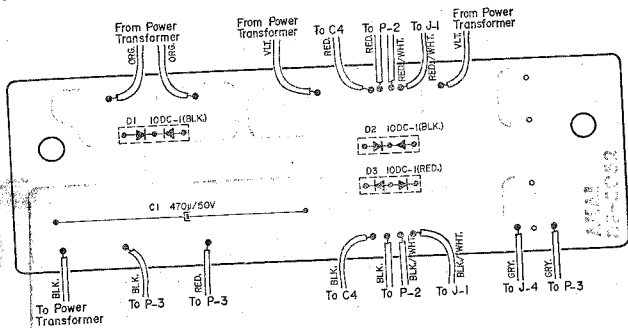

POWER SUPPLY P.C. BOARD (DF-5052) (DECK)

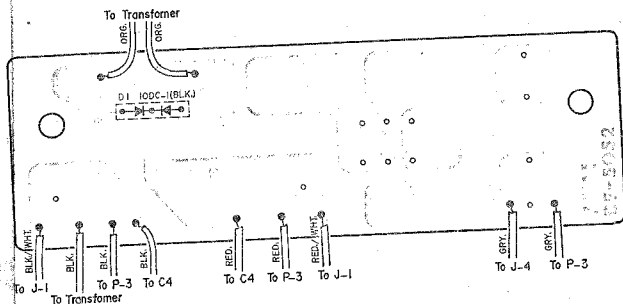

## 5. 4-CHANNEL PHASE CHECK

### Method A

- 1) Connect front left signal and front right signal from the line output terminal to vertical and horizontal input of Oscilloscope. (See Fig. 11).
- 2) Playback a 250 Hz "0" VU pre-recorded test tape at 7-1/2 ips (500 Hz "0" VU pre-recorded test tape at 3-3/4 ips).
- 3) If front left and front right are In-Phase, the waveform as shown in Fig. 12 will appear on the oscilloscope screen.
- 4) If phase is 180° out of phase, a waveform as shown in Fig. 13 will appear on the oscilloscope screen.
- 5) Make the same check on front left/rear left and rear left/rear right.
- 6) The line outputs should be In-Phase. If not, Recording/Playback Head needs adjusting.

### Method B (See Fig. 14)

- 1) Playback a 250 Hz "0" VU pre-recorded test tape at 7-1/2 ips (500 Hz "0" VU pre-recorded test tape at 3-3/4 ips).
- 2) Connect front left signal and front right signal of line output terminals in parallel and connect this to a high sensitivity V.T.V.M. (Model 161 A).
- 3) If In-Phase, the line output will be about +4 dB.
- 4) At 180° out of phase, the line output will be about -5 dB.
- 5) Make the same check on front left/rear left and rear left/rear right.

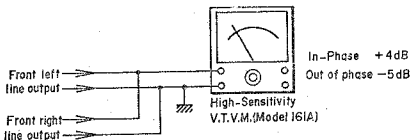

Fig. 14

## MUTE CIRCUIT OPERATING PRINCIPLES

### 1. At Cartridge Mode (See Fig. 15)

When the Track Selectors are operated (Sensing Tape, Manual Track Selector, or Remote Track Selector), base current flows to TR-2 through R-3 and R-6, TR-2 is turned "ON", and Relay RL-2 is also turned "ON". When RL-2 is turned "ON", because the pre-amp line output is shorted, no sound is emitted from the speaker or line output, and various kinds of clicking noises, etc. are completely cut.

### 2. At Reel or Transfer Mode (See Fig. 16)

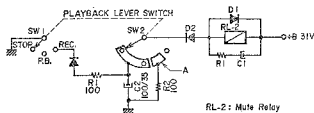

Fig. 16

When the Playback Lever is at Stop or P.B. position, a charge current flows to C-2 through Mute Relay RL-2, D-2 and SW-2, fully charging C-2 when at a steady state. Consequently, RL-2 is turned "OFF". Momentarily, when the Playback Lever is turned to REC from P.B., current flows to RL-2 through Resistor R-2 which is connected to contact point A located between P.B. contact point and REC contact point. Until the Playback Lever perfectly reaches REC position, RL-2 is "ON". Consequently, mute condition is effected and noise from the amplifier is cut.

When the Playback Lever reaches perfect REC position, Mute Relay RL-2 becomes an open circuit. Because Mute Relay is "OFF", a perfect REC condition is obtained. At this REC condition, the electric charge (which charged C-2 at STOP or P.B. mode) flows through R-1, D-3, SW-1, and C-2 is discharged.

Next, when the Playback Lever is turned from REC → P.B. → STOP, when the lever reaches P.B., current momentarily flows to Mute Relay RL-2 from contact point A through R-2 and Mute Relay is turned "ON". And then when the Playback Lever reaches P.B. contact point, a charge current flows to C-2 (which was discharged at REC mode) through D-2 and SW-2. Consequently, because C-2 charge current flows to Mute Relay RL-2, Mute Relay is turned "ON" and C-2 charge progresses. The charge-current is decreased to a certain extent and because the Mute Relay is caused to function,

when a point below the necessary charge is reached, Mute Relay RL-2 is turned "OFF".

Accordingly, when the Playback Lever is turned from STOP → P.B. → REC or REC → P.B. → STOP, Mute Relay RL-2 operates to completely cut the various clicking noises from the amplifier.

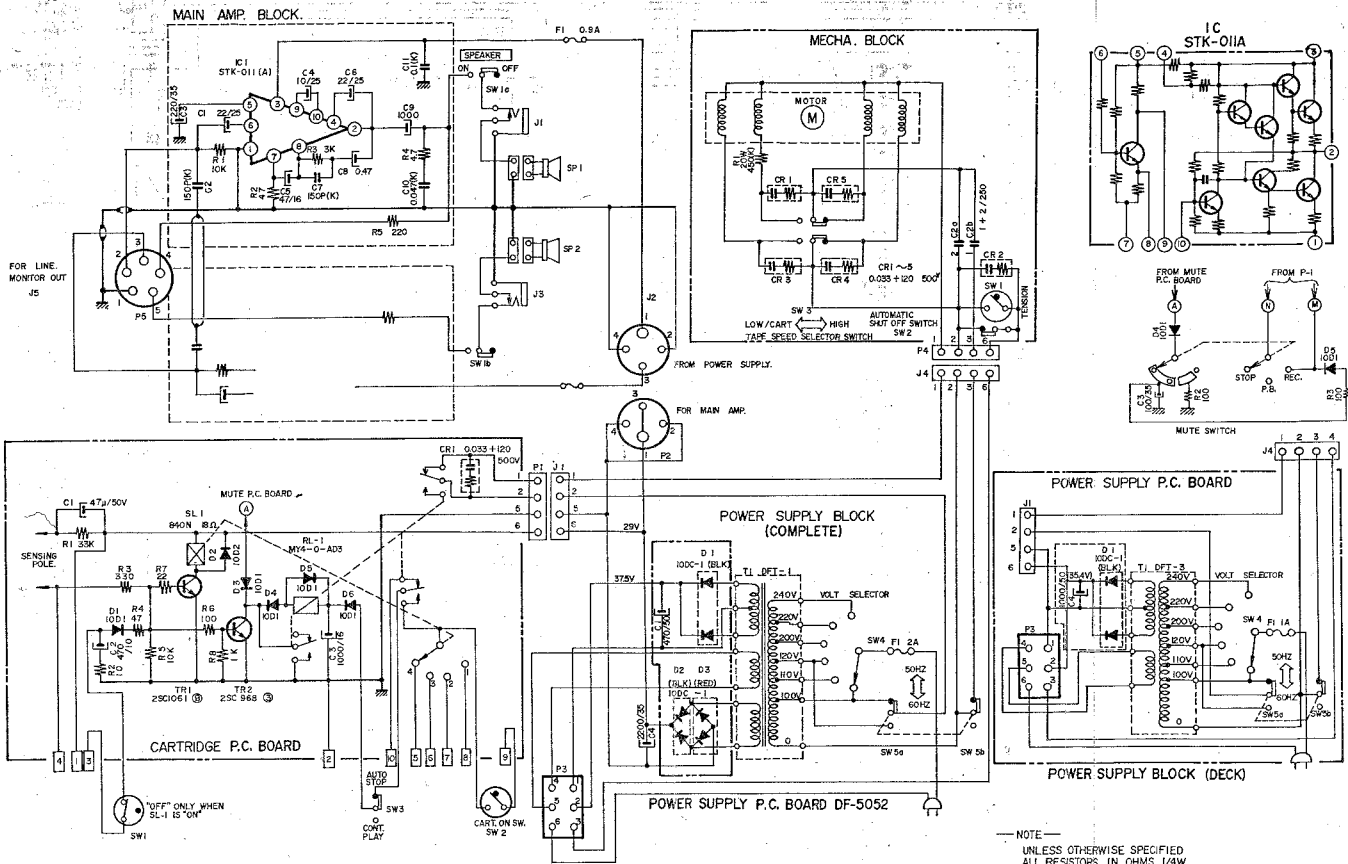

— NOTE —  
 UNLESS OTHERWISE SPECIFIED  
 ALL RESISTORS IN OHMS 1/4W  
 ALL CAPACITORS IN MFD. (K) 50VW  
 P=M. MFD.

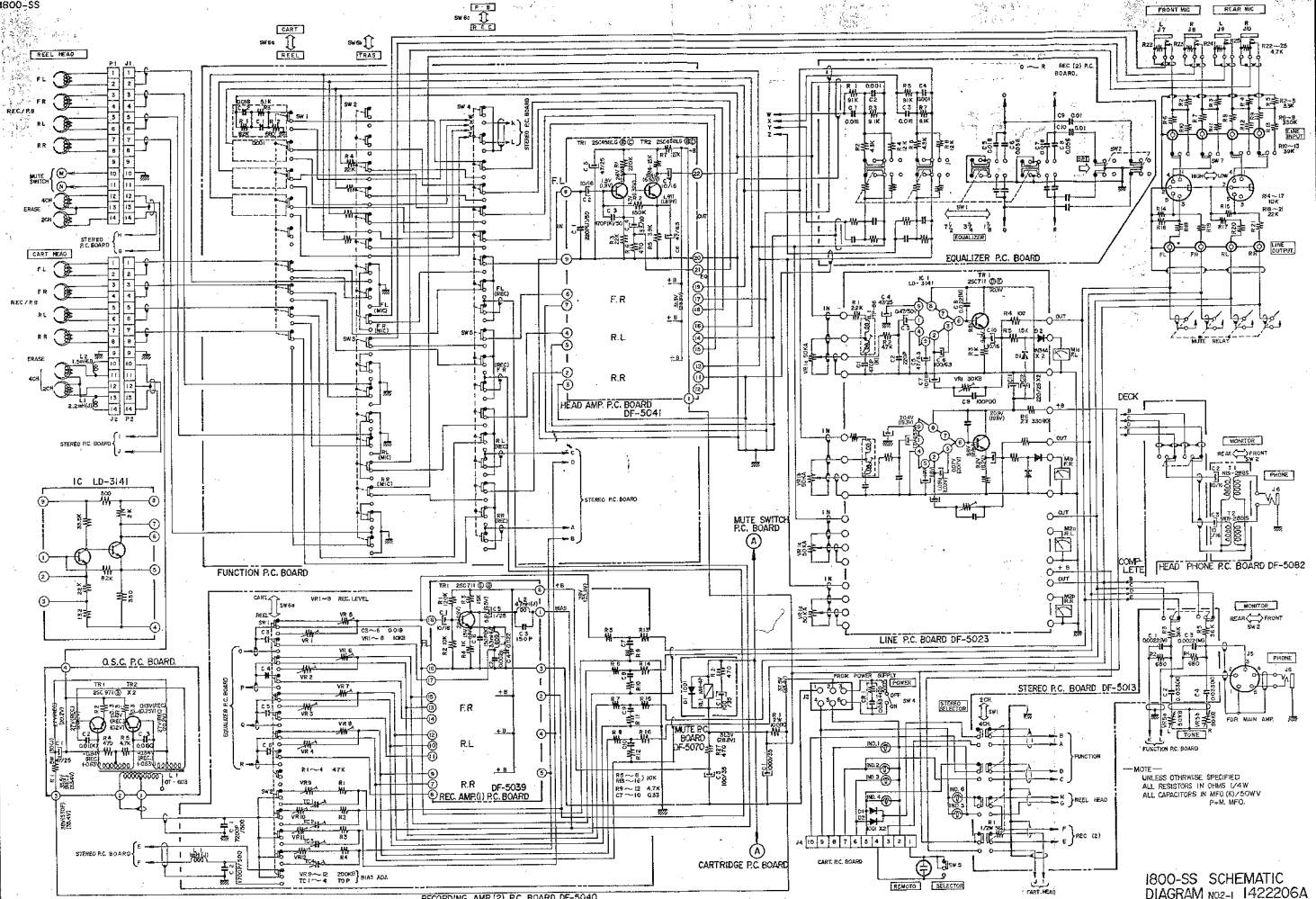

RECORDING AMP (2) P.C. BOARD DF-5040

1800-SS SCHEMATIC DIAGRAM N02-1 142206A